

Table of Contents

Introduction	4
Instrument Cluster	12
Warning lights and chimes	12
Gauges	18
Entertainment Systems	22
AM/FM stereo	22
AM/FM stereo with CD/MP3	24
Auxiliary input jack (Line in)	32
USB port	34
Satellite radio information	37
Navigation system	40
SYNC®	40
Climate Controls	41
Manual heating and air conditioning	41
Dual electronic automatic temperature control	44
Navigation system based climate control	49
Rear window defroster	53
Lights	54
Headlamps	54
Turn signal control	58
Bulb replacement	59
Driver Controls	65
Windshield wiper/washer control	65
Steering wheel adjustment	66
Power windows	72
Mirrors	74
Speed control	80
Message center	89
Tailgate	113

Table of Contents

Locks and Security	126
Keys	126
Locks	126
Anti-theft system	139
Seating and Safety Restraints	143
Seating	143
Safety restraints	161
Airbags	180
Child restraints	193
Tires, Wheels and Loading	216
Tire information	218
Tire inflation	220
Tire Pressure Monitoring System (TPMS)	233
Vehicle loading	244
Trailer towing	250
Trailer brake controller-integrated	257
Recreational towing	263
Driving	265
Starting	265
Brakes	272
AdvanceTrac®	274
Transmission operation	281
Reverse sensing system	292
Reverse camera	294
Snowplowing	308
Roadside Emergencies	312
Getting roadside assistance	312
Hazard flasher control	313
Fuses and relays	314
Changing tires	322
Wheel lug nut torque	330
Jump starting	331
Wrecker towing	337

Table of Contents

Customer Assistance	339
Reporting safety defects (U.S. only)	345
Reporting safety defects (Canada only)	345
Cleaning	346
Maintenance and Specifications	355
Engine compartment	357
Engine oil	360
Battery	363
Engine coolant	365
Fuel information	371
Air filter(s)	389
Part numbers	392
Maintenance product specifications and capacities	393
Engine data	397
Accessories	401
Index	403

All rights reserved. Reproduction by any means, electronic or mechanical including photocopying, recording or by any information storage and retrieval system or translation in whole or part is not permitted without written authorization from Ford Motor Company. Ford may change the contents without notice and without incurring obligation.

Copyright © 2009 Ford Motor Company

<https://www.MyCarManual.com>

Introduction

CONGRATULATIONS

Congratulations on acquiring your new Ford Motor Company product. Please take the time to get well acquainted with your vehicle by reading this handbook. The more you know and understand about your vehicle, the greater the safety and pleasure you will derive from driving it.

For more information on Ford Motor Company and its products visit the following website:

- In the United States: www.ford.com
- In Canada: www.ford.ca
- In Mexico: www.ford.com.mx
- In Australia: www.ford.com.au

Additional owner information is given in separate publications.

This vehicle's *Owner's Guide* describes every option and model variant available and therefore some of the items covered may not apply to your particular vehicle. Furthermore, due to printing cycles it may describe options before they are generally available.

Remember to pass on this vehicle's *Owner's Guide* when reselling the vehicle. It is an integral part of the vehicle.

SAFETY AND ENVIRONMENT PROTECTION

Warning symbols in this guide

How can you reduce the risk of personal injury to yourself or others? In this guide, answers to such questions are contained in comments highlighted by the warning triangle symbol. These comments should be read and observed.

Warning symbols on your vehicle

When you see this symbol, it is imperative that you consult the relevant section of this guide before touching or attempting adjustment of any kind.



Introduction

Protecting the environment

We must all play our part in protecting the environment. Correct vehicle usage and the authorized disposal of waste, cleaning and lubrication materials are significant steps towards this aim. Information in this respect is highlighted in this guide with the tree symbol.



CALIFORNIA Proposition 65 Warning



WARNING: Engine exhaust, some of its constituents, and certain vehicle components contain or emit chemicals known to the State of California to cause cancer and birth defects or other reproductive harm. In addition, certain fluids contained in vehicles and certain products of component wear contain or emit chemicals known to the State of California to cause cancer and birth defects or other reproductive harm.

PERCHLORATE MATERIAL

Certain components of this vehicle such as airbag modules, seat belt pretensioners, and button cell batteries may contain Perchlorate Material – Special handling may apply for service or vehicle end of life disposal. See www.dtsc.ca.gov/hazardouswaste/perchlorate.

BREAKING-IN YOUR VEHICLE

Your vehicle does not need an extensive break-in. Try not to drive continuously at the same speed for the first 1,000 miles (1,600 km) of new vehicle operation. Vary your speed frequently in order to give the moving parts a chance to break in.

Drive your new vehicle at least 1,000 miles (1,600 km) before towing a trailer. For more detailed information about towing a trailer, refer to *Trailer towing* in the *Tires, Wheels and Loading* chapter.

Do not add friction modifier compounds or special break-in oils since these additives may prevent piston ring seating. See *Engine oil* in the *Maintenance and Specifications* chapter for more information on oil usage.

Introduction

SPECIAL NOTICES

New Vehicle Limited Warranty

For a detailed description of what is covered and what is not covered by your vehicle's New Vehicle Limited Warranty, refer to the *Warranty Guide/Customer Information Guide* that is provided to you along with your *Owner's Guide*.

Special instructions

For your added safety, your vehicle is fitted with sophisticated electronic controls.



WARNING: Please read the section *Airbag Supplemental Restraint System (SRS)* in the *Seating and Safety Restraints* chapter. Failure to follow the specific warnings and instructions could result in personal injury.



WARNING: Front seat mounted rear-facing child or infant seats should **NEVER** be placed in front of an active passenger airbag.

Service Data Recording

Service data recorders in your vehicle are capable of collecting and storing diagnostic information about your vehicle. This potentially includes information about the performance or status of various systems and modules in the vehicle, such as engine, throttle, steering or brake systems. In order to properly diagnose and service your vehicle, Ford Motor Company, Ford of Canada, and service and repair facilities may access vehicle diagnostic information through a direct connection to your vehicle when diagnosing or servicing your vehicle. For U.S. only (if equipped), if you choose to use the SYNC® Vehicle Health Report, you consent that certain diagnostic information may also be accessed electronically by Ford Motor Company and Ford authorized service facilities, and that the diagnostic information may be used for any purpose. See your SYNC® supplement for more information.

Introduction

Event Data Recording

Other modules in your vehicle — event data recorders — are capable of collecting and storing data during a crash or near crash event. The recorded information may assist in the investigation of such an event. The modules may record information about both the vehicle and the occupants, potentially including information such as:

- how various systems in your vehicle were operating;
- whether or not the driver and passenger seatbelts were buckled;
- how far (if at all) the driver was depressing the accelerator and/or the brake pedal;
- how fast the vehicle was traveling; and
- where the driver was positioning the steering wheel.

To access this information, special equipment must be directly connected to the recording modules. Ford Motor Company and Ford of Canada do not access event data recorder information without obtaining consent, unless pursuant to court order or where required by law enforcement, other government authorities or other third parties acting with lawful authority. Other parties may seek to access the information independently of Ford Motor Company and Ford of Canada. Please note that once 911 Assist (if equipped) is enabled (set ON), 911 Assist may, through any paired and connected cell phone, disclose to emergency services that the vehicle has been in a crash involving the deployment of an airbag or, in certain vehicles, the activation of the fuel pump shut-off. Certain versions or updates to 911 Assist may also be capable of electronically or verbally disclosing to 911 operators the vehicle location, and/or other details about the vehicle or crash to assist 911 operators to provide the most appropriate emergency services. If you do not want to disclose this information, do not activate the feature. See your SYNC® supplement for more information.

Using your vehicle with a snowplow

For more information and guidelines for using your vehicle with a snowplow, refer to the *Driving* chapter.

Introduction

Using your vehicle as an ambulance

Do not use this vehicle as an ambulance.

Your vehicle is not equipped with the Ford Ambulance Preparation Package.

Notice to owners of pickup trucks and utility type vehicles



WARNING: Utility vehicles have a significantly higher rollover rate than other types of vehicles.

Before you drive your vehicle, please read this *Owner's Guide* carefully. Your vehicle is not a passenger car. As with other vehicles of this type, failure to operate this vehicle correctly may result in loss of vehicle control, vehicle rollover, personal injury or death.

Notice to owners of the F150

Note: Your vehicle is equipped with high performance tires. When first driving the vehicle after it has been parked for a period of time, you may experience a temporary ride disturbance. This is a characteristic of the tires and should be no reason for concern. The condition should correct itself within 5-15 miles (8-25 km) of driving. If the disturbance persists, have the tires serviced by an authorized dealer.

Cell phone use

The use of Mobile Communications Equipment has become increasingly important in the conduct of business and personal affairs. However, drivers must not compromise their own or others' safety when using such equipment. Mobile Communications can enhance personal safety and security when appropriately used, particularly in emergency situations. Safety must be paramount when using mobile communications equipment to avoid negating these benefits.

Mobile Communication Equipment includes, but is not limited to cellular phones, pagers, portable email devices, in-vehicle communications systems, telematics devices and portable two-way radios.

Introduction



WARNING: Driving while distracted can result in loss of vehicle control, accident and injury. Ford strongly recommends that drivers use extreme caution when using any device that may take their focus off the road. The driver's primary responsibility is the safe operation of their vehicle. Only use cell phones and other devices not essential to the driving task when it is safe to do so.



















Export unique (Non–United States/Canada) vehicle specific information

For your particular global region, your vehicle may be equipped with features and options that are different from the features and options that are described in this *Owner's Guide*. A market unique supplement may be supplied that complements this book. By referring to the market unique supplement, if provided, you can properly identify those features, recommendations and specifications that are unique to your vehicle. This *Owner's Guide* is written primarily for the U.S. and Canadian Markets. Features or equipment listed as standard may be different on units built for Export. **Refer to this Owner's Guide for all other required information and warnings.**

Introduction





















These are some of the symbols you may see on your vehicle.

Vehicle Symbol Glossary

Safety Alert		See Owner's Guide	
Fasten Safety Belt		Airbag - Front	
Airbag - Side		Child Seat Lower Anchor	
Child Seat Tether Anchor		Brake System	
Anti-Lock Brake System		Parking Brake System	
Brake Fluid - Non-Petroleum Based		Parking Aid System	
Stability Control System		Speed Control	
Master Lighting Switch		Hazard Warning Flasher	
Fog Lamps-Front		Fuse Compartment	
Fuel Pump Reset		Windshield Wash/Wipe	
Windshield Defrost/Demist		Rear Window Defrost/Demist	

Introduction

Vehicle Symbol Glossary

Power Windows Front/Rear		Power Window Lockout	
Child Safety Door Lock/Unlock		Interior Luggage Compartment Release	
Panic Alarm		Engine Oil	
Engine Coolant		Engine Coolant Temperature	
Do Not Open When Hot		Battery	
Avoid Smoking, Flames, or Sparks		Battery Acid	
Explosive Gas		Fan Warning	
Power Steering Fluid		Maintain Correct Fluid Level	
Service Engine Soon		Engine Air Filter	
Passenger Compartment Air Filter		Jack	
Check Fuel Cap		Low Tire Pressure Warning	

Instrument Cluster

WARNING LIGHTS AND CHIMES

Standard instrument cluster

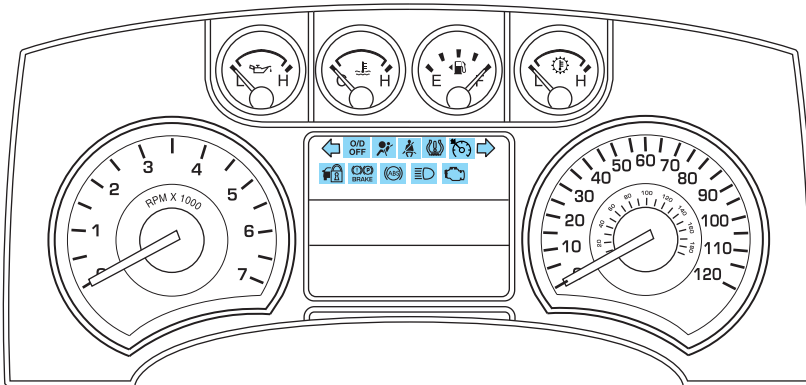

Platinum instrument cluster

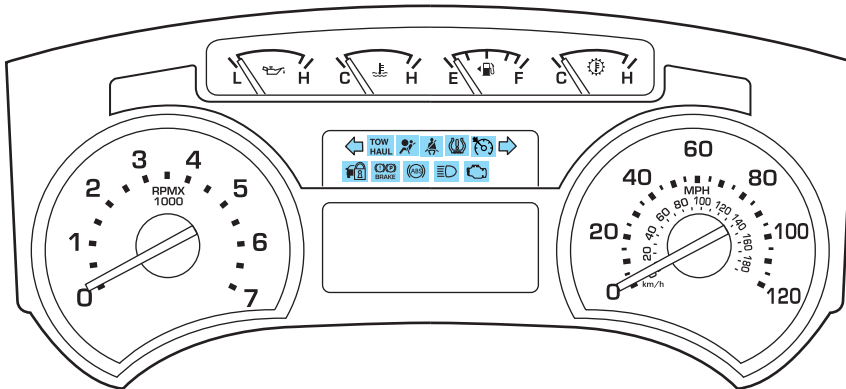

Warning lights and gauges can alert you to a vehicle condition that may become serious enough to cause expensive repairs. A warning light may illuminate when a problem exists with one of your vehicle's functions. Many lights will illuminate when you start your vehicle to make sure the

Instrument Cluster

bulb works. If any light remains on after starting the vehicle, refer to the respective system warning light for additional information.

Note: Some warning lights are reconfigurable telltale (RTT) indicator lights and will illuminate in the message center display below the speedometer. These lights function the same as the other warning lights.

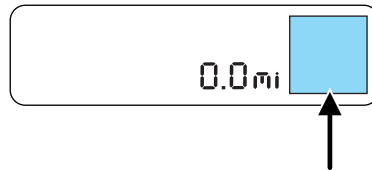

Service engine soon: The service engine soon indicator light illuminates when the ignition is first turned to the on position to check the bulb and to indicate whether the vehicle is ready for Inspection/Maintenance (I/M) testing. Normally, the service engine soon light will stay on until the engine is cranked, then turn itself off if no malfunctions are present. However, if after 15 seconds the service engine soon light blinks eight times, it means that the vehicle is not ready for I/M testing. See the *Readiness for Inspection/Maintenance (I/M) testing* in the *Maintenance and Specifications* chapter.

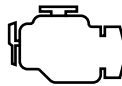

Solid illumination after the engine is started indicates the On Board Diagnostics System (OBD-II) has detected a malfunction. Refer to *On board diagnostics (OBD-II)* in the *Maintenance and Specifications* chapter. If the light is blinking, engine misfire is occurring which could damage your catalytic converter. Drive in a moderate fashion (avoid heavy acceleration and deceleration) and have your vehicle serviced immediately by your authorized dealer.

 **WARNING:** Under engine misfire conditions, excessive exhaust temperatures could damage the catalytic converter, the fuel system, interior floor coverings or other vehicle components, possibly causing a fire.

Electronic throttle control (RTT) (if equipped): Displays when the engine has defaulted to a “limp-home” operation. Report the fault to a dealer at the earliest opportunity.



Instrument Cluster

On vehicles equipped with a message center, “ENGINE FAILSAFE MODE” will be displayed, refer to *Message center* in the *Driver Controls* chapter.

Brake system warning light: To confirm the brake system warning light is functional, it will momentarily illuminate when the ignition is turned to the on position when the engine is not running, or in a position between on and start, or by applying the parking brake when the ignition is turned to the on position.



If the brake system warning light does not illuminate at this time, seek service immediately from your authorized dealer. Illumination after releasing the parking brake indicates low brake fluid level and the brake system should be inspected immediately by your authorized dealer.

 **WARNING:** Driving a vehicle with the brake system warning light on is dangerous. A significant decrease in braking performance may occur. It will take you longer to stop the vehicle. Have the vehicle checked by your authorized dealer. Driving extended distances with the parking brake engaged can cause brake failure and the risk of personal injury.

Anti-lock brake system: If the ABS light stays illuminated or continues to flash, a malfunction has been detected, have the system serviced immediately by your authorized dealer. Normal braking is still functional unless the brake warning light also is illuminated.



Airbag readiness: If this light fails to illuminate when the ignition is turned to on, continues to flash or remains on, have the system serviced immediately by your authorized dealer. A chime will sound if there is a malfunction in the indicator light.



Instrument Cluster

Safety belt: Reminds you to fasten your safety belt. A Belt-Minder® chime will also sound to remind you to fasten your safety belt. Refer to the *Seating and Safety Restraints* chapter to activate/deactivate the Belt-Minder® chime feature.



Charging system (RTT): Illuminates when the battery is not charging properly. If it stays on while the engine is running, there may be a malfunction with the charging system. Contact your authorized dealer as soon as possible. This indicates a problem with the electrical system or a related component.



Engine oil pressure (RTT): Displays when the oil pressure falls below the normal range. Refer to *Engine oil* in the *Maintenance and Specifications* chapter.



Door ajar (RTT): Displays when the ignition is in the on position and any door is open.



Engine coolant temperature (RTT): Illuminates when the engine coolant temperature is high. Stop the vehicle as soon as possible, switch off the engine and let cool. Refer to *Engine coolant* in the *Maintenance and Specifications* chapter.



WARNING: Never remove the coolant reservoir cap while the engine is running or hot.

Instrument Cluster

Low tire pressure warning:

Illuminates when your tire pressure is low. If the light remains on at start up or while driving, the tire pressure should be checked. Refer to *Inflating your tires* in the *Tires, Wheels and Loading* chapter. When the ignition is first turned to on, the light will illuminate for three seconds to ensure the bulb is working. If the light does not turn on, have the system inspected by your authorized dealer. For more information on this system, refer to *Tire pressure monitoring system (TPMS)* in the *Tires, Wheels and Loading* chapter.

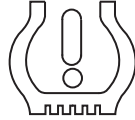

Overdrive off (if equipped):

Illuminates when the overdrive function of the transmission has been turned off; refer to the *Driving* chapter. If the light does not illuminate, have the transmission serviced soon, or damage may occur.

O/D
OFF

Transmission Tow/Haul Feature (six speed transmission only):

Displays when the Tow/Haul feature has been activated. Refer to the *Driving* chapter for transmission function and operation. If the light flashes steadily, have the system serviced immediately, damage to the transmission could occur.

TOW
HAUL

AdvanceTrac®/Traction Control™ (RTT) (if equipped):

Displays when the AdvanceTrac®/Traction Control™ is active. If the light remains on, have the system serviced immediately, refer to the *Driving* chapter for more information.



4X2 (RTT) (if equipped):

Displays when two-wheel drive high is engaged. If the light fails to display when the ignition is turned on, or remains on, have the system serviced immediately by your authorized dealer.

4x2

Instrument Cluster

Four wheel drive low (RTT) (if equipped):

Displays when four-wheel drive low is engaged. If the light fails to display when the ignition is turned on, or remains on, have the system serviced immediately by your authorized dealer.

**4x4
LOW**

Four wheel drive high (RTT) (if equipped):

Displays when four-wheel drive high is engaged. If the light fails to display when the ignition is turned on, or remains on, have the system serviced immediately by your authorized dealer.

**4x4
HIGH**

Electronic locking differential (RTT) (if equipped):

Displays when using the electronic locking differential.



Speed control: Illuminates when the speed control is activated. Turns off when the speed control system is deactivated.



Anti-theft system: Flashes when the SecuriLock™ Passive Anti-theft System has been activated.



Turn signal: Illuminates when the left or right turn signal or the hazard lights are turned on. If the indicators stay on or flash faster, check for a burned out bulb.



High beams: Illuminates when the high beam headlamps are turned on.



Key-in-ignition warning chime: Sounds when the key is left in the ignition in the off or accessory position and the driver's door is opened.

Headlamps on warning chime: Sounds when the headlamps or parking lamps are on, the ignition is off (the key is not in the ignition) and the driver's door is opened.

Instrument Cluster

GAUGES

Standard instrument cluster

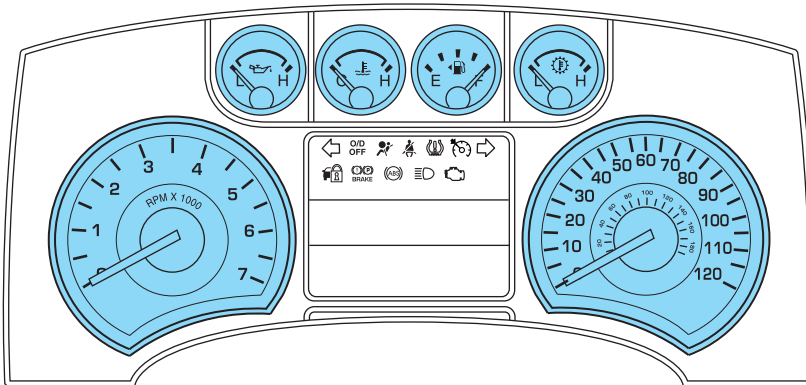

Platinum instrument cluster

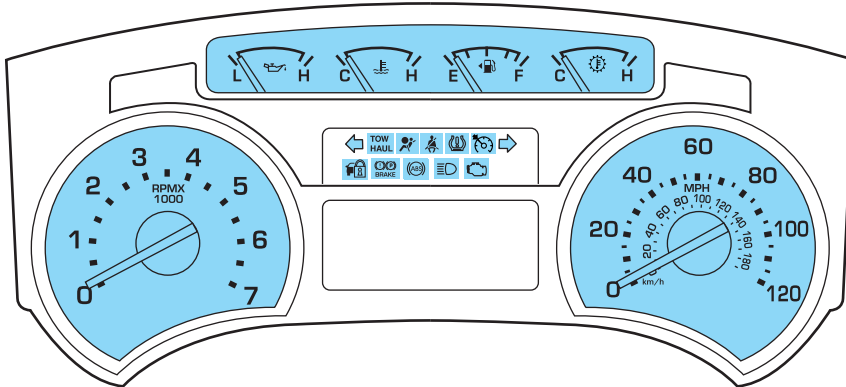

Instrument Cluster

Speedometer: Indicates the current vehicle speed.

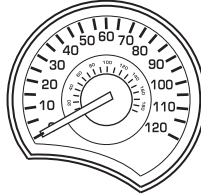

Engine coolant temperature gauge: Indicates engine coolant temperature. At normal operating temperature, the needle will be in the normal range (between “H” and “C”). If it enters the red section, the engine is overheating. Stop the vehicle as soon as safely possible, switch off the engine and let the engine cool.

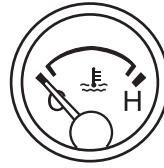

WARNING: Never remove the coolant reservoir cap while the engine is running or hot.

Odometer: Registers the total miles (kilometers) of the vehicle.

Refer to *Message center* in the *Driver Controls* chapter on how to switch the display from Metric to English.



000000.0 mi

Trip odometer: Registers the miles (kilometers) of individual journeys.

- With standard message center

Press the SELECT/RESET stem once to switch from the odometer to the trip odometer. Press the stem again to select Trip A and Trip B features. To reset the trip, press and hold the stem until it resets.

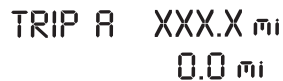

TRIP A XXX.X mi
0.0 mi

Instrument Cluster

Tachometer (if equipped):

Indicates the engine speed in revolutions per minute. Driving with your tachometer pointer continuously at the top of the scale may damage the engine.

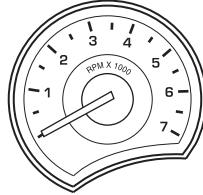

Engine oil pressure gauge:

Indicates engine oil pressure. The needle should stay in the normal operating range (between "L" and "H"). If the needle falls below the normal range, stop the vehicle, turn off the engine and check the engine oil level. Add oil if needed. If the oil level is correct, have your vehicle checked by your authorized dealer.

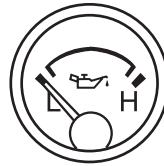

Fuel gauge: Indicates approximately how much fuel is left in the fuel tank (when the ignition is in the on position). The fuel gauge may vary slightly when the vehicle is in motion or on a grade.



The arrow next to the fuel pump icon indicates which side of the vehicle the fuel filler inlet is located.

For more information, refer to *Filling the tank* in the *Maintenance and Specifications* chapter.

Transmission fluid temperature gauge: If the gauge is in the:

Normal area (normal) - the transmission fluid is within the normal operating temperature (between "H" and "C").

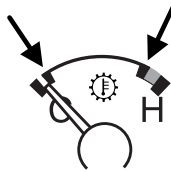

Instrument Cluster

Yellow area (warning) — the transmission fluid is higher than normal operating temperature. This can be caused by special operation conditions (i.e. snowplowing, towing or off road use). Refer to *Special Operating Conditions* in the *scheduled maintenance*

information for instructions. Operating the transmission for extended periods of time with the gauge in the yellow area may cause internal transmission damage.

Altering the severity of the driving conditions is recommended to lower the transmission temperature into the normal range.

Red area (over temperature) — the transmission fluid is overheating. Stop the vehicle to allow the temperature to return to normal range.

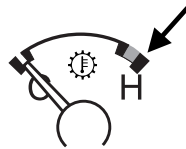
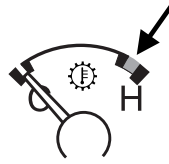

If the gauge is operating in the Yellow or Red area, stop the vehicle and verify the airflow is not restricted such as snow or debris blocking airflow through the grill. If the gauge continues to show high temperatures, see your authorized dealer.

Entertainment Systems

AUDIO SYSTEMS

AM/FM stereo system (if equipped)

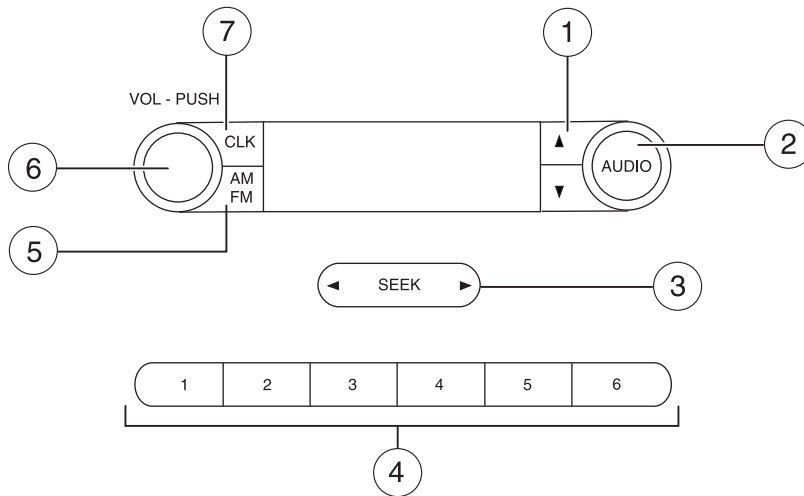

WARNING: Driving while distracted can result in loss of vehicle control, accident and injury. Ford strongly recommends that drivers use extreme caution when using any device that may take their focus off the road. The driver's primary responsibility is the safe operation of their vehicle. Only use cell phones and other devices not essential to the driving task when it is safe to do so.

Accessory delay: Your vehicle is equipped with accessory delay which allows you to operate the radio and other electrical accessories for up to ten minutes after the ignition has been turned off or until either front door is opened.

1. ▲ / ▼ : Press ▲ / ▼ to manually go up or down the radio frequency. Press and hold for a fast advance through radio frequencies. Also use in AUDIO mode to gain access to various settings.



Entertainment Systems

2. **AUDIO:** Press AUDIO repeatedly to gain access to the following settings:



BAL (Balance): Press AUDIO to reach the balance setting. Use ▲ / ▼ / ◀ SEEK ▶ to adjust the audio between the left (L) and right (R) speakers.

FAD (Fade): Press AUDIO to reach the fade feature. Use ▲ / ▼ / ◀ SEEK ▶ to adjust the audio between the front (F) and back (B) speakers.

TREB (Treble): Press to adjust the treble setting. Use ▲ / ▼ / ◀ SEEK ▶ to adjust.

BASS (Bass): Press to adjust the bass setting. Use ▲ / ▼ / ◀ SEEK ▶ to adjust.

3. **SEEK:** Press ◀ SEEK ▶ to access the previous/next strong station.



4. **Memory presets:** To set a station: Select frequency band AM/FM1/FM2; tune to a station, press and hold a preset button until sound returns. You can save up to 18 stations, six in AM, six in FM1 and FM2.



5. **AM/FM:** Press AM/FM to select AM/FM1/FM2 frequency band.



6. **ON/OFF/Volume:** Press VOL-PUSH to turn ON/OFF. Turn VOL-PUSH to increase/decrease volume.

VOL - PUSH



7. **CLK (Clock):** Press CLK to toggle between displaying the radio frequency and the clock setting.



Entertainment Systems

Setting the clock: Press and hold CLK until the hours begin to flash. Press ▲ /▼ /◀ SEEK ▶ to manually increase/decrease the hours. Press CLK again to set the minutes using ▲ /▼ /◀ SEEK ▶ to manually increase/decrease the minutes. Allow 10 seconds to pass to confirm that the time has been set.

AM/FM in-dash CD/MP3 satellite compatible sound system

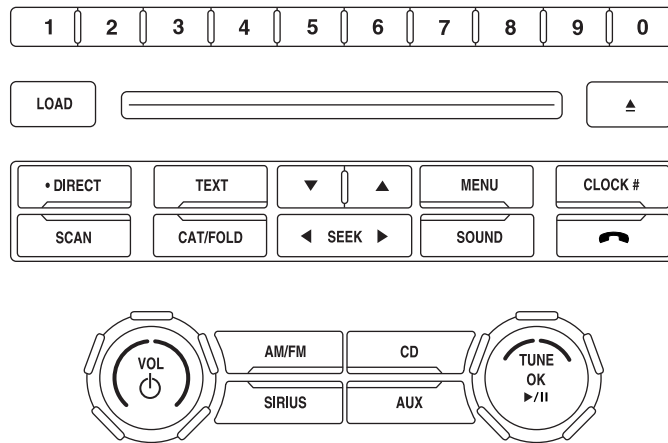

WARNING: Driving while distracted can result in loss of vehicle control, accident and injury. Ford strongly recommends that drivers use extreme caution when using any device that may take their focus off the road. The driver's primary responsibility is the safe operation of their vehicle. Only use cell phones and other devices not essential to the driving task when it is safe to do so.

Accessory delay: Your vehicle is equipped with accessory delay. With this feature, the radio and other electrical accessories may be used for up to ten minutes after the ignition is turned off or until either front door is opened.

Entertainment Systems

Note: Your vehicle is equipped with a unique audio system. If your display shows six small circles in the display, your audio system is a CD6 system (six disc changer). If not, your system is a single CD system.

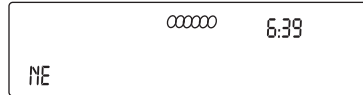

Setting the clock

To set the time, press CLOCK. The display will read SET TIME. Use the memory preset numbers (0–9) to enter in the desired time—hours and minutes. The clock will then begin from that time.

AM/FM Radio

⏻ / VOL (Power/Volume): Press to turn the radio on/off. Turn the knob to increase/decrease volume.

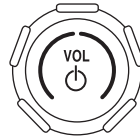

If the volume is set above a certain level and the ignition is turned off, the volume will come back on at a nominal listening level when the ignition switch is turned back on.

AM/FM: Press repeatedly to select AM/FM1/FM2 frequency band.

TUNE: Turn the knob to go up/down the frequency band in individual increments.



DIRECT: Press DIRECT and then manually enter the desired radio station (i.e. 93.9) using the memory preset numbers (0–9).

SEEK: Press ◀ SEEK ▶ to access the previous/next strong radio station.

SCAN: Press for a brief sampling of all strong radio stations.

0–9 (MEMORY PRESETS): When tuned to any station, press and hold a preset button until sound returns and PRESET # SAVED appears in the display. You can save up to 30 stations, 10 in AM, 10 in FM1 and FM2.

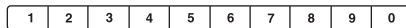

Saving presets automatically: Autoset allows you to set the strongest local radio stations without losing your original manually set preset stations for AM/FM1/FM2.

Entertainment Systems

To activate the autoseek feature: Press MENU repeatedly until AUTO PRESET ON/OFF appears in the display. Use ◀ SEEK ▶ to toggle AUTO PRESET to ON, and either wait five seconds for the search to initiate or press OK to immediately initiate the search. If you press another control within those five seconds, the search will not initiate. The 10 strongest stations will be filled and the station stored in preset 1 will begin playing.

If there are fewer than 10 strong stations, the system will store the last one in the remaining presets.

RDBS Radio

Available only in FM mode. This feature allows you to search RDBS-equipped stations for a certain category of music format: CLASSIC, COUNTRY, JAZZ/RB, ROCK, etc.

To activate: Press MENU repeatedly until RDBS (ON/OFF) appears in the display. Use ◀ SEEK ▶ to toggle RDBS ON/OFF. When RDBS is off, you will not be able to search for RDBS equipped stations or view the station name or type.

CAT/FOLD (Category/Folder): This feature allows you to select from various music categories.

To change RDBS categories: Press MENU repeatedly until RDBS ON/OFF appears in the display. Use ◀ SEEK ▶ to toggle RDBS between ON/OFF. Press CAT. PRESS UP OR DOWN TO CHANGE RDBS CATEGORY will appear in the display.

Press ▼ ▲ to scroll through all possible categories. When the desired category appears in the display, press ◀ SEEK ▶ to find the next station playing that selection or press SCAN for a brief sampling of all stations playing that category of music.

CD/MP3 Player

CD: Press to enter CD/MP3 mode. If a disc is already loaded into the system, CD/MP3 play will begin where it ended last. If no CD is loaded, NO DISC will appear in the display.

LOAD:

For a single CD system– This control is not operational. To load a CD, simply insert the disc, label side up, into the CD slot.

For a CD6 system– Press LOAD. When the display reads SELECT SLOT, choose the desired slot number using memory presets 1–6. When the display reads LOAD CD #, load the desired disc, label side up. If you

Entertainment Systems

do not choose a slot within five seconds, the system will choose for you. Once loaded, the first track will begin to play.

To auto load up to six discs– Press and hold LOAD until the display reads AUTOLOAD #. Load the desired disc, label side up. The system will prompt you to load discs for the remaining available slots. Insert the discs, one at a time, label side up, when prompted. Once loaded, the disc in preset #1 will begin to play.

Press the number preset buttons (1–6) to choose the disc you want to play.

▶ / || Play/Pause: Press to play/pause a track when playing a CD.



▲ (Eject):

For a single CD system– press ▲ to eject the CD.

For a CD6 system– press ▲ and select the desired CD slot by pressing the corresponding memory preset number. The display will read EJECTING #. When the system has ejected the CD, the display will read REMOVE CD #. Remove the CD. If you do not remove the CD, the system will reload the disc.

To auto eject all loaded discs– Press and hold ▲. The system will eject all discs and prompt you when to remove them.

SEEK: Press ◀ SEEK ▶ to access the previous/next track.

CAT (Category) / FOLD (Folder):

In MP3 mode only– Press CAT/FOLD and then press ◀ SEEK ▶ to access the previous/next folder.

SCAN: Press for a brief sampling of all tracks on the current disc or MP3 folder.

DIRECT:

In CD mode– Press DIRECT. The display will read DIRECT TRACK MODE SELECT TRACK. Enter the desired track number using the memory preset buttons (0–9). The system will then begin playing that track.

In MP3 folder mode– Press DIRECT and the memory preset buttons (0–9) of the desired folder. The system will advance to that specific folder.

Entertainment Systems

TEXT:

In MP3 mode only– Press TEXT repeatedly to view Album (AL), Folder (FL), Song (SO) and Artist (AR) in the display, if available.

In TEXT MODE: Sometimes the display requires additional text to be displayed. When the < / > indicator is active, press TEXT and then press ◀ SEEK ▶ to view the additional display text.

COMPRESSION: Press MENU repeatedly until COMPRESSION ON/OFF appears in the display. Use ◀ SEEK ▶ to toggle between ON/OFF. When COMPRESSION is ON, the system will bring the soft and loud CD passages together for a more consistent listening level.

SHUFFLE: Press MENU repeatedly until SHUFFLE ON/OFF appears in the display. Use ◀ SEEK ▶ to toggle between ON/OFF. If you wish to engage shuffle mode right away, press ◀ SEEK ▶ to begin random play. Otherwise, random play will begin when the current track is finished playing. The system will only shuffle the disc currently playing.

Satellite Radio (if equipped)

Satellite radio is available only with a valid SIRIUS radio subscription. Check with your authorized dealer for availability.

SIRIUS: Press repeatedly to access satellite radio mode, if equipped. Press repeatedly to cycle through SAT1, SAT2 and SAT3 modes.

TUNE: Turn to go to the next / previous available SIRIUS satellite station.

DIRECT: Press DIRECT then enter the desired channel (i.e. 002) using the memory preset buttons (0–9). If you only enter one digit, press OK and the system will go to that satellite channel. If you enter three digits, the system will automatically go to that channel, if available. You may cancel your entry by pressing DIRECT. If an invalid station number is entered, INVALID CHANNEL will appear in the display and the system will continue playing the current station.

SEEK: Press ◀ SEEK ▶ to seek to the previous/next channel. If a specific category is selected, (Jazz, Rock, News, etc.), press ◀ SEEK ▶ to seek to the previous/next channel in the selected category. Press and hold ◀ SEEK ▶ to fast seek through the previous/next channels.

SCAN: Press SCAN for a brief sampling of all available SIRIUS satellite channels. If a specific category is selected, (Jazz, Rock, News, etc.) press SCAN for a brief sampling of all available SIRIUS satellite channels within the selected category.

Entertainment Systems

MEMORY PRESETS (0-9): There are 30 available presets, 10 each for SAT1, SAT2 and SAT3. To save satellite channels in your memory presets, tune to the desired channel then press and hold a memory preset number (0-9) until sound returns.



TEXT: Press and release to display the artist and song title. While in TEXT MODE, press again to scroll through the Artist (AR), Song (SO), Channel (CH) and Category (CA).

In TEXT MODE: Sometimes the display requires additional text to be displayed. When the < / > indicator is active, press TEXT and then press ◀ SEEK ▶ to view the additional display text.

CAT (Category) / FOLD (Folder): Press to toggle between turning the most recently selected satellite radio category on or off. The category icon (CAT) will illuminate in the display when a specific category is selected (the icon will not illuminate during CATEGORY ALL). If no category has ever been selected, NO CATEGORY SELECTED will display.

Note: Separate categories can be set for SAT1, SAT2 or SAT3. Refer to *Satellite radio menu* for further information on selecting a satellite radio category.

SATELLITE RADIO MENU: Press MENU when satellite radio mode is active to access. Press OK to enter into the satellite radio menu.

Press ▼ ▲ to cycle through the following options:

- **CATEGORY-** Press OK to enter category mode. Press ▼ ▲ to scroll through the list of available SIRIUS channel Categories (Pop, Rock, News, etc.) Press OK when the desired category appears in the display. After a category is selected, press ◀ SEEK ▶ to search for that specific category of channels only (i.e. ROCK). You may also select CATEGORY ALL to seek all available SIRIUS categories and channels. Press OK to close and return to the main menu.
- **SONG SEEK MENU-** Press OK to enter song seek menu. Press ▼ ▲ to scroll through the following options:
 - a. SAVE THIS SONG:** Press OK to save the currently playing song's title in the system's memory. (If you try to save something other than a song, CANT SAVE will appear in the display.) When the chosen song is playing on any satellite radio channel, the system will alert you with an audible prompt. Press OK while SONG ALERT is in the display and the system will take you to the channel playing the desired song. You can save up to 20 song titles. If you attempt to save more than 20

Entertainment Systems

titles, the display will read REPLACE SONG? Press OK to access the saved titles and press ▼ ▲ to cycle through the saved titles. When the song title appears in the display that you would like to replace, press OK. SONG REPLACED will appear in the display.

b. DELETE A SONG: Press OK to delete a song from the system's memory. Press ▼ ▲ to cycle through the saved songs. When the song appears in the display that you would like to delete, press OK. The song will appear in the display for confirmation. Press OK again and the display will read SONG DELETED. If you do not want to delete the currently listed song, press ▼ ▲ to select either RETURN or CANCEL.

c. DELETE ALL SONGS: Press OK to delete all song's from the system's memory. The display will read ARE YOU SURE ? Press OK to confirm deletion of all saved songs and the display will read ALL DELETED.

d. DISABLE ALERTS/ENABLE ALERTS: Press OK to enable/disable the satellite alert status which alerts you when your selected songs are playing on a satellite radio channel. (The system default is disabled.) SONG ALERTS ENABLED/DISABLED will appear in the display. The menu listing will display the opposite state. For example, if you have chosen to enable the song alerts, the menu listing will read DISABLE as the alerts are currently on, so your other option is to turn them off.

- **CHANNEL LOCKOUT MENU-** Press OK to enter the Channel Lockout menu. Press the ▼ ▲ to scroll through the following options:
 - a. LOCK/UNLOCK THIS CHANNEL:** Press OK when LOCK/UNLOCK THIS CHANNEL is displayed and the display will read ENTER PIN. Enter your four-digit PIN number (initial PIN is 1234) and the system will lock/unlock the channel and CHANNEL LOCKED or UNLOCKED will be displayed.
Note: you must be tuned to the specific channel you want to lock/unlock when using this feature.
 - b. CHANGE PIN:** Press OK when CHANGE PIN is displayed. The display will read ENTER OLD PIN. Enter your current (old) PIN number and when the system accepts your entry it will display ENTER NEW PIN. Enter your new four-digit PIN and the system will save the new PIN and PIN SAVED will display.

Entertainment Systems

c. UNLOCK ALL CHANNELS: Press OK when UNLOCK ALL CHANNELS is displayed and the display will read ENTER PIN. Enter your four-digit PIN and the system will unlock all channels and the display will read CHANNEL UNLOCKED.

d. RESET PIN: Press OK when RESET PIN is displayed. The display will read ARE YOU SURE. Press OK again to automatically reset the PIN number to its initial password setting (1234). PIN RESET TO DEFAULT PIN will be displayed.

e. RETURN: Press OK when RETURN is displayed and the system will exit back to the satellite radio menu.

Sound Adjustments

Press SOUND repeatedly to cycle through the following features:

BASS: Press ◀ SEEK ▶ to adjust the level of bass.

TREBLE: Press ◀ SEEK ▶ to adjust the level of treble.

BALANCE: Press ◀ SEEK ▶ to adjust the audio between the left (L) and right (R) speakers.

FADE: Press ◀ SEEK ▶ to adjust the audio between the back (B) and front (F) speakers.

SPEED COMPENSATED VOLUME: With this feature on, radio volume automatically gets louder with increasing vehicle speed to compensate for road and wind noise.

The default setting is *off*.

Use ◀ SEEK ▶ to adjust between SPEED OFF and levels 1–7:

Increasing the level from 1 (lowest setting) to 7 (highest setting) allows the radio volume to automatically change slightly with vehicle speed to compensate for road and wind noise.

Recommended level is 1–3; SPEED OFF turns the feature off and level 7 is the maximum setting.

Extra Features

AUX: Press repeatedly to cycle through LINE IN (auxiliary audio mode), and SYNC (if equipped).

For location and further information on auxiliary audio mode, refer to *Auxiliary input jack* later in this chapter.

If your vehicle is equipped with SYNC, please refer to supplemental information on SYNC.

Entertainment Systems

OK: Your vehicle may be equipped with special phone and media features which will require you to confirm commands by pressing OK. For further information, refer to supplemental information on *SYNC*.



(Phone): If your vehicle is equipped with SYNC, press to access SYNC PHONE features. For further information, please refer to supplemental information on *SYNC*. If your vehicle is not equipped with SYNC, the display may read NO PHONE.

Audio system—Navigation system based (if equipped)

If your vehicle is equipped with the navigation system, it will have an integrated navigation/audio system. See the *Navigation system* supplement for operating instructions on using this audio system.

Auxiliary input jack (Line in — if equipped)



WARNING: Driving while distracted can result in loss of vehicle control, accident and injury. Ford strongly recommends that drivers use extreme caution when using any device that may take their focus off the road. The driver's primary responsibility is the safe operation of their vehicle. Only use cell phones and other devices not essential to the driving task when it is safe to do so.

The Auxiliary Input Jack provides a way to connect your portable music player to the in-vehicle audio system. This allows the audio from a portable music player to be played through the vehicle speakers with high fidelity. To achieve optimal performance, please observe the following instructions when attaching your portable music device to the audio system.

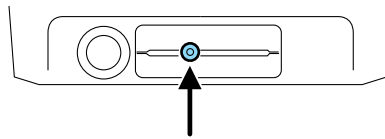

If your vehicle is equipped with a navigation system, refer to *Auxiliary input jack* section in the *Audio features* chapter of your *Navigation system* supplement.

Required equipment:

1. Any portable music player designed to be used with headphones
2. An audio extension cable with stereo male 1/8 in. (3.5 mm) connectors at each end

Entertainment Systems

To play your portable music player using the auxiliary input jack:

1. Begin with the vehicle parked and the radio turned off.
2. Ensure that the battery in your portable music player is new or fully charged and that the device is turned off.
3. Attach one end of the audio extension cable to the headphone output of your player and the other end of the audio extension cable to the AIJ in your vehicle.
4. Turn the radio on, using either a tuned FM station or a CD loaded into the system. Adjust the volume to a comfortable listening level.
5. Turn the portable music player on and adjust the volume to 1/2 the volume.
6. Press AUX on the vehicle radio repeatedly until LINE, LINE IN or SYNC LINE IN appears in the display.
You should hear audio from your portable music player although it may be low.
7. Adjust the sound on your portable music player until it reaches the level of the FM station or CD by switching back and forth between the AUX and FM or CD controls.

Troubleshooting:

1. Do not connect the audio input jack to a line level output. Line level outputs are intended for connection to a home stereo and are not compatible with the AIJ. The AIJ will only work correctly with devices that have a headphone output with a volume control.
2. Do not set the portable music player's volume level higher than is necessary to match the volume of the CD or FM radio in your audio system as this will cause distortion and will reduce sound quality. Many portable music players have different output levels, so not all players should be set at the same levels. Some players will sound best at full volume and others will need to be set at a lower volume.
3. If the music sounds distorted at lower listening levels, turn the portable music player volume down. If the problems persists, replace or recharge the batteries in the portable music player.
4. The portable music player must be controlled in the same manner when it is used with headphones as the AIJ does not provide control (play, pause, etc.) over the attached portable music player.
5. For safety reasons, connecting or adjusting the settings on your portable music player should not be attempted while the vehicle is moving. Also, the portable music player should be stored in a secure

Entertainment Systems

location, such as the center console or the glove box, when the vehicle is in motion. The audio extension cable must be long enough to allow the portable music player to be safely stored while the vehicle is in motion.

USB port (if equipped)



WARNING: Driving while distracted can result in loss of vehicle control, accident and injury. Ford strongly recommends that drivers use extreme caution when using any device that may take their focus off the road. The driver's primary responsibility is the safe operation of their vehicle. Only use cell phones and other devices not essential to the driving task when it is safe to do so.

Your vehicle may be equipped with a USB port located on the instrument panel. This feature allows you to plug in media playing devices, memory sticks, and also to charge devices if they support this feature. For further information on this feature, refer to *Accessing and using your USB port* in the *SYNC* supplement or *Navigation system* supplement.

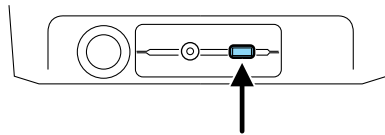

GENERAL AUDIO INFORMATION

Radio frequencies:

AM and FM frequencies are established by the Federal Communications Commission (FCC) and the Canadian Radio and Telecommunications Commission (CRTC). Those frequencies are:

AM: 530, 540–1700, 1710 kHz

FM: 87.7, 87.9–107.7, 107.9 MHz

Radio reception factors:

There are three factors that can affect radio reception:

- Distance/strength: The further you travel from an FM station, the weaker the signal and the weaker the reception.
- Terrain: Hills, mountains, tall buildings, power lines, electric fences, traffic lights and thunderstorms can interfere with your reception.
- Station overload: When you pass a broadcast tower, a stronger signal may overtake a weaker one and play while the weak station frequency is displayed.

Entertainment Systems

CD/CD player care

Do:

- Handle discs by their edges only. (Never touch the playing surface).
- Inspect discs before playing.
- Clean only with an approved CD cleaner.
- Wipe discs from the center out.

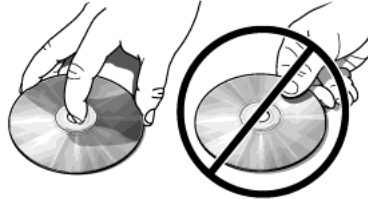

Don't:

- Expose discs to direct sunlight or heat sources for extended periods of time.
- Clean using a circular motion.

CD units are designed to play commercially pressed 4.75 in (12 cm) audio compact discs only. Due to technical incompatibility, certain recordable and re-recordable compact discs may not function correctly when used in Ford CD players.

Do not use any irregular shaped CDs or discs with a scratch protection film attached.

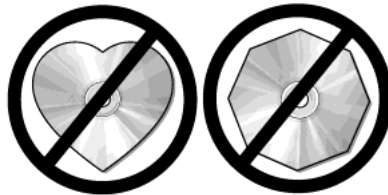

Entertainment Systems

CDs with homemade paper (adhesive) labels should not be inserted into the CD player as the label may peel and cause the CD to become jammed. It is recommended that homemade CDs be identified with permanent felt tip marker rather than adhesive labels. Ballpoint pens may damage CDs. Please contact your authorized dealer for further information.



Audio system warranty and service

Refer to the *Warranty Guide/Customer Information Guide* for audio system warranty information. If service is necessary, see your dealer or qualified technician.

MP3 track and folder structure

Your MP3 system recognizes MP3 individual tracks and folder structure as follows:

- There are two different modes for MP3 disc playback: MP3 track mode (system default) and MP3 folder mode. For more information on track and folder mode, refer to *Sample MP3 structure* in the following section.
- MP3 track mode ignores any folder structure on the MP3 disc. The player numbers each MP3 track on the disc (noted by the .mp3 file extension) from T001 to a maximum of T255.
Note: The maximum number of playable MP3 files may be less depending on the structure of the CD and exact model of radio present.
- MP3 folder mode represents a folder structure consisting of one level of folders. The CD player numbers all MP3 tracks on the disc (noted by the .mp3 file extension) and all folders containing MP3 files, from F001 (folder) T001 (track) to F253 T255.
- Creating discs with only one level of folders will help with navigation through the disc files.

Entertainment Systems

Sample MP3 structure

If you are burning your own MP3 discs, it is important to understand how the system will read the structures you create. While various files may be present, (files with extensions other than mp3), only files with the .mp3 extension will be played. This enables you to use the same MP3 disc for a variety of tasks on your work computer, home computer and your in vehicle system.

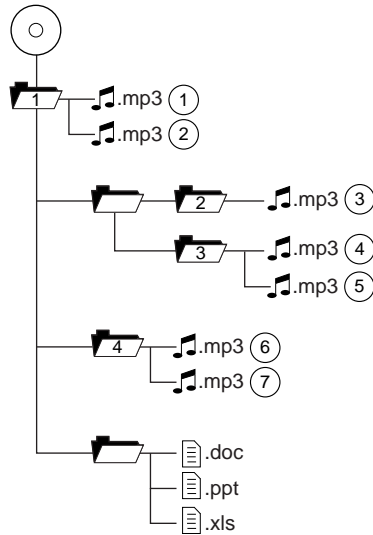

In track mode, the system will display and play the structure as if it were only one level deep (all .mp3 files will be played, regardless of being in a specific folder). In folder mode, the system will only play the .mp3 files in the current folder.

Satellite radio information (if equipped)

Satellite radio channels: SIRIUS broadcasts a variety of music, news, sports, weather, traffic and entertainment satellite radio channels. For more information and a complete list of SIRIUS satellite radio channels, visit www.sirius.com in the United States, www.sirius-canada.ca in Canada, or call SIRIUS at 1-888-539-7474.

Satellite radio reception factors: To receive the satellite signal, your vehicle has been equipped with a satellite radio antenna located on the roof of your vehicle. The vehicle roof provides the best location for an unobstructed, open view of the sky, a requirement of a satellite radio system. Like AM/FM, there are several factors that can affect satellite radio reception performance:

- **Antenna obstructions:** For optimal reception performance, keep the antenna clear of snow and ice build-up and keep luggage and other material as far away from the antenna as possible.

Entertainment Systems

- Terrain: Hills, mountains, tall buildings, bridges, tunnels, freeway overpasses, parking garages, dense tree foliage and thunderstorms can interfere with your reception.
- Station overload: When you pass a ground based broadcast repeating tower, a stronger signal may overtake a weaker one and result in an audio mute.

Unlike AM/FM audible static, you will hear an audio mute when there is a satellite radio signal interference. Your radio display may display NO SIGNAL to indicate the interference.

SIRIUS satellite radio service: SIRIUS Satellite Radio is a subscription based satellite radio service that broadcasts music, sports, news and entertainment programming. A service fee is required in order to receive SIRIUS service. Vehicles that are equipped with a factory installed SIRIUS Satellite Radio system include:

- Hardware and limited subscription term, which begins on the date of sale or lease of the vehicle.
- Use of online media player providing access to all SIRIUS music channels over the internet using any computer connected to the internet (U.S. customers only).

For information on extended subscription terms, contact SIRIUS at 1-888-539-7474.

Note: SIRIUS reserves the unrestricted right to change, rearrange, add or delete programming including canceling, moving or adding particular channels, and its prices, at any time, with or without notice to you. Ford Motor Company shall not be responsible for any such programming changes.

Satellite Radio Electronic Serial Number (ESN): This 12-digit Satellite Serial Number is needed to activate, modify or track your satellite radio account. You will need this number when communicating with SIRIUS. While in Satellite Radio mode, you can view this number on the radio display by pressing AUX and Preset 1 control simultaneously.

Entertainment Systems

Radio Display	Condition	Action Required
ACQUIRING	Radio requires more than two seconds to produce audio for the selected channel.	No action required. This message should disappear shortly.
SAT FAULT	Internal module or system failure present.	If this message does not clear within a short period of time, or with an ignition key cycle, your receiver may have a fault. See your authorized dealer for service.
INVALID CHNL	Channel no longer available.	This previously available channel is no longer available. Tune to another channel. If the channel was one of your presets, you may choose another channel for that preset button.
UNSUBSCRIBED	Subscription not available for this channel.	Contact SIRIUS at 1-888-539-7474 to subscribe to the channel or tune to another channel.
NO TEXT	Artist information not available.	Artist information not available at this time on this channel. The system is working properly.
NO TEXT	Song title information not available.	Song title information not available at this time on this channel. The system is working properly.

Entertainment Systems

Radio Display	Condition	Action Required
NO TEXT	Category information not available.	Category information not available at this time on this channel. The system is working properly.
NO SIGNAL	Loss of signal from the SIRIUS satellite or SIRIUS tower to the vehicle antenna.	You are in a location that is blocking the SIRIUS signal (i.e., tunnel, under an overpass, dense foliage, etc). The system is working properly. When you move into an open area, the signal should return.
UPDATING	Update of channel programming in progress.	No action required. The process may take up to three minutes.
CALL SIRIUS 1-888-539-7474	Satellite service has been deactivated by SIRIUS Satellite Radio.	Call SIRIUS at 1-888-539-7474 to re-activate or resolve subscription issues.

NAVIGATION SYSTEM (IF EQUIPPED)

Your vehicle may be equipped with a navigation system. Refer to the *Navigation system* supplement for further information.







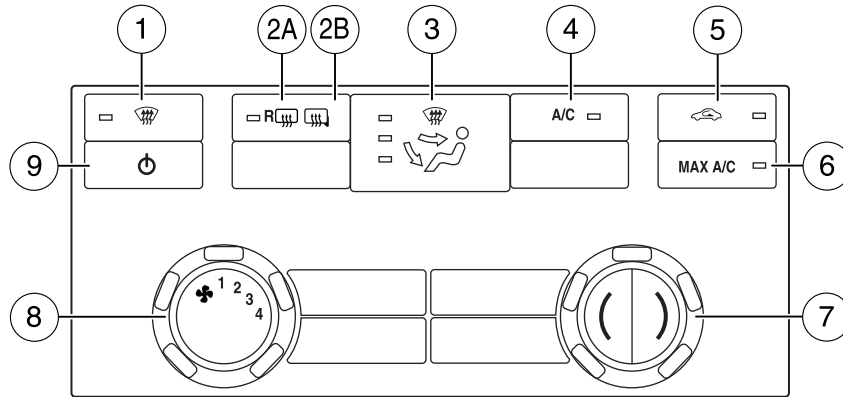

SYNC® (IF EQUIPPED)

Your vehicle may be equipped with SYNC®, a hands-free communications and entertainment system with special phone and media features. For more information, please refer to the *SYNC®* supplement or to the *SYNC®* section in the *Navigation system* supplement (if equipped).









Climate Controls

SINGLE ZONE CLIMATE CONTROL





1.  **Defrost:** Distributes outside air through the windshield defroster vents and de-mister vents. Can be used to clear the windshield of fog and thin ice. The system will automatically provide outside air to reduce window fogging. Press this button again to return to the previous air flow selection.
2. A.  **Rear defroster (if equipped):** Press to activate/deactivate the rear window defroster. Refer to *Rear window defroster* later in this chapter for more information. If your vehicle is equipped with both rear defroster and heated mirrors, the same button will activate both.
2. B.  **Heated mirrors (if equipped):** Press to activate/deactivate. This feature will remove ice and snow from the side view mirrors.
3.  **Multifunction control:** Press repeatedly to toggle through the settings to choose:
 -  : Distributes air through the windshield defroster vents, de-mister vents, floor vents and rear seat floor vents. The system will automatically provide outside air to reduce window fogging.
 -  : Distributes air through the instrument panel vents.
 -  : Distributes air through the instrument panel vents, floor vents, rear seat floor vents and de-mister vents.
 -  : Distributes air through the floor vents and rear seat floor vents.

Climate Controls

4. **A/C:** Press to activate/deactivate air conditioning. Use with recirculated air to improve cooling performance and efficiency. A/C engages automatically in MAX A/C,  (defrost) and  (floor/defrost).
5.  **Recirculated air:** Press to activate/deactivate air recirculation in the vehicle. Recirculated air may reduce the amount of time needed to cool down the interior of the vehicle and may also help reduce undesired odors from reaching the interior of the vehicle. Recirculated air engages automatically when MAX A/C is selected or can be engaged manually in any airflow mode except  (defrost). When the ignition switch is turned off and back on, the climate system will return to the recirculated air mode only if the A/C button LED is illuminated and the air distribution selection is either  (panel) or  (panel/floor).
6. **MAX A/C:** Distributes recirculated air through the instrument panel vents to cool the vehicle. This re-cooling of the interior air is more economical and efficient. Recirculated air may also help reduce undesirable odors from entering the vehicle. Press the MAX A/C button again for normal A/C operation.
7. **Temperature control:** Controls the temperature of the airflow in the vehicle.
8.  **Fan speed adjustment:** Controls the volume of air circulated in the vehicle.
9.  **Power:** Press to activate/deactivate the climate control system. When the system is off, outside air is prevented from entering the vehicle.

Operating tips

- To reduce fog build up on the windshield during humid weather, place the air flow selector in the  (defrost) or  (floor/defrost) position. Temperature and/or fan speed can also be increased to improve clearing.
- To reduce humidity build up inside the vehicle: do not drive with the system off or with recirculated air engaged.
- Do not put objects under the front seats that will interfere with the airflow to the back seats.
- Remove any snow, ice or leaves from the air intake area at the base of the windshield.

Climate Controls

- To improve the A/C cool down, drive with the windows slightly open for 2-3 minutes after start up or until the vehicle has been “aired out.”
- If you are driving during extreme high ambient temperatures and idling for extended periods of time in gear, it is recommended to run the A/C in the MAX A/C position, adjust the blower fan speed to the lowest setting and put the vehicle’s transmission into the P (Park) position to continue to receive cool air from your A/C system.
- For maximum cooling performance (Max A/C):

Max A/C mode:

- Move the temperature control to the coolest setting.
- Set the fan to the highest speed initially, then adjust to maintain comfort.

Panel () and panel/floor () modes:

- Move the temperature control to the coolest setting.
- Select A/C and recirculated air (). Use recirculated air with A/C to provide colder airflow.
- Set the fan to the highest speed initially, then adjust to maintain comfort.
- To aid in side window defogging/demisting in cold weather:

1. Select  .
2. Select A/C.
3. Adjust the temperature control to maintain comfort.
4. Set the fan speed to the highest setting.
5. Direct the outer instrument panel vents towards the side windows.

To increase airflow to the outer instrument panel vents, close the vents located in the middle of the instrument panel.

Climate Controls



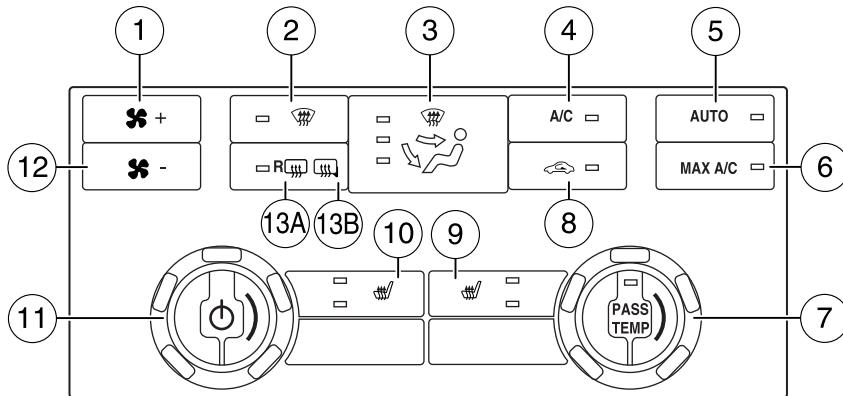





DUAL ZONE AUTOMATIC TEMPERATURE CONTROL WITH HEATED SEATS (IF EQUIPPED)





Temperature conversion: To switch between Fahrenheit and Celsius, refer to *Message center* in the *Driver Controls* chapter.

1. **+ Fan speed control:** Press to increase the fan speed.
2. **Defrost:** Distributes outside air through the windshield defroster vents and de-mister vents. Can be used to clear the windshield of fog and thin ice. The system will automatically provide outside air to reduce window fogging. Press this button again to return to the previous air flow selection.
3. **Manual override control:** Allows you to manually select where airflow is directed. To return to full automatic control, press AUTO. When choosing to control airflow manually, press repeatedly to toggle through the settings to choose:
 - : Distributes air through the windshield defroster vents, de-mister vents, floor vents and rear seat floor vents. The system will automatically provide outside air to reduce window fogging.
 - : Distributes air through the instrument panel vents.
 - : Distributes air through the instrument panel vents, floor vents, rear seat floor vents and de-mister vents.
 - : Distributes air through the floor vents and rear seat floor vents.

Climate Controls

4. **A/C:** Press to activate/deactivate air conditioning. Use with recirculated air to improve cooling performance and efficiency. A/C engages automatically in MAX A/C,  (defrost) and  (floor/defrost).
5. **AUTO:** Press to engage automatic temperature control. Select the desired temperature using the temperature control. The system will automatically determine fan speed, airflow location, A/C on or off, and outside or recirculated air, to heat or cool the vehicle to reach the desired temperature.
6. **MAX A/C:** Distributes recirculated air through the instrument panel vents to cool the vehicle. This re-cooling of the interior air is more economical and efficient. Recirculated air may also help reduce undesirable odors from entering the vehicle. Press the MAX A/C button again for normal A/C operation.
7. **PASS TEMP:** Press to activate separate passenger temperature control and turn the dial to increase/decrease the airflow temperature for the passenger in the front of the vehicle.
8.  **Recirculated air:** Press to activate/deactivate air recirculation in the vehicle. Recirculated air may reduce the amount of time needed to cool down the interior of the vehicle and may also help reduce undesired odors from reaching the interior of the vehicle. Recirculated air engages automatically when MAX A/C is selected or can be engaged manually in any airflow mode except  (defrost). When the ignition switch is turned off and back on, the climate system will return to the recirculated air mode only if the A/C button LED is illuminated and the air distribution selection is either  (panel) or  (panel/floor).
9.  **Passenger heated seat control:** Press to control the passenger heated seat. Refer to *Heated seats* in the *Seating and Safety Restraints* chapter for more information.
10.  **Driver heated seat control:** Press to control the driver heated seat. Refer to *Heated seats* in the *Seating and Safety Restraints* chapter for more information.
11.  **Power/Driver temperature:** Press to activate/deactivate the climate control system. When the system is off, outside air is prevented from entering the vehicle. Turn to increase/decrease the air temperature on the driver side of the vehicle. The control also adjusts the passenger side temperature when PASS TEMP is disengaged. The recommended initial setting is between 72°F (22°C) and 75°F (24°C), then adjust for comfort. The driver side temperature setting will appear in the upper left corner of the display.



Climate Controls

12.  – **Front fan speed control:** Press to decrease the fan speed.
13. A.  **Rear defroster (if equipped):** Press to activate/deactivate the rear window defroster. Refer to *Rear window defroster* later in this chapter for more information. If your vehicle is equipped with both rear defroster and heated mirrors, the same button will activate both.
13. B.  **Heated mirrors (if equipped):** Press to activate/deactivate. This feature will remove ice and snow from the side view mirrors.

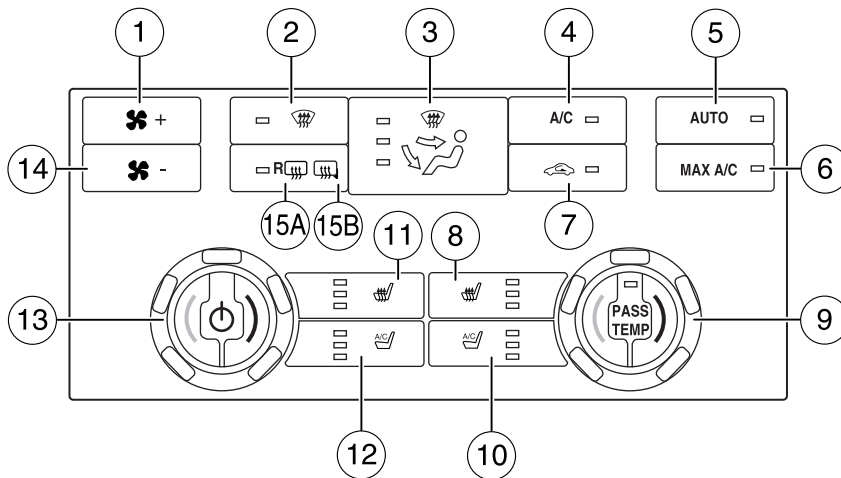











DUAL ZONE AUTOMATIC TEMPERATURE CONTROL WITH HEATED AND COOLED SEATS (IF EQUIPPED)









Temperature conversion: To switch between Fahrenheit and Celsius, refer to *Message center* in the *Driver Controls* chapter.

-  + **Fan speed control:** Press to increase the fan speed.
-  **Defrost:** Distributes outside air through the windshield defroster vents and de-mister vents. Can be used to clear the windshield of fog and thin ice. The system will automatically provide outside air to reduce window fogging. Press this button again to return to the previous air flow selection.

Climate Controls

3.  **Manual override control:** Allows you to manually select where airflow is directed. To return to full automatic control, press AUTO. When choosing to control airflow manually, press repeatedly to toggle through the settings to choose:
 -  : Distributes air through the windshield defroster vents, de-mister vents, floor vents and rear seat floor vents. The system will automatically provide outside air to reduce window fogging.
 -  : Distributes air through the instrument panel vents.
 -  : Distributes air through the instrument panel vents, floor vents, rear seat floor vents and de-mister vents.
 -  : Distributes air through the floor vents and rear seat floor vents.
4. **A/C:** Press to activate/deactivate air conditioning. Use with recirculated air to improve cooling performance and efficiency. A/C engages automatically in MAX A/C,  (defrost) and  (floor/defrost).
5. **AUTO:** Press to engage automatic temperature control. Select the desired temperature using the temperature control. The system will automatically determine fan speed, airflow location, A/C on or off, and outside or recirculated air, to heat or cool the vehicle to reach the desired temperature.
6. **MAX A/C:** Distributes recirculated air through the instrument panel vents to cool the vehicle. This re-cooling of the interior air is more economical and efficient. Recirculated air may also help reduce undesirable odors from entering the vehicle. Press the MAX A/C button again for normal A/C operation.
7.  **Recirculated air:** Press to activate/deactivate air recirculation in the vehicle. Recirculated air may reduce the amount of time needed to cool down the interior of the vehicle and may also help reduce undesired odors from reaching the interior of the vehicle. Recirculated air engages automatically when MAX A/C is selected or can be engaged manually in any airflow mode except  (defrost). When the ignition switch is turned off and back on, the climate system will return to the recirculated air mode only if the A/C button LED is illuminated and the air distribution selection is either  (panel) or  (panel/floor).
8.  **Passenger heated seat:** Press to control the passenger heated seat. Refer to *Heated and cooled seats* in the *Seating and Safety Restraints* chapter for more information.

Climate Controls



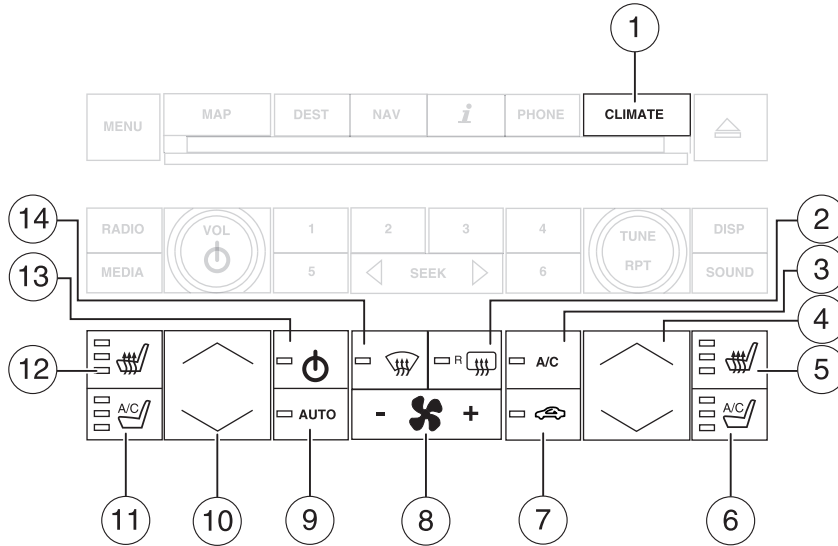

9. **PASS TEMP:** Press to engage/disengage separate passenger side temperature control. Turn to increase/decrease the air temperature on the passenger side of the vehicle. The recommended initial setting is between 72°F (22°C) and 75°F (24°C), then adjust for comfort. The passenger side temperature setting will appear in the upper right corner of the display.
10.  **Passenger cooled seat:** Press to control the passenger cooled seat. Refer to *Heated and cooled seats* in the *Seating and Safety Restraints* chapter for more information.
11.  **Driver heated seat:** Press to control the driver heated seat. Refer to *Heated and cooled seats* in the *Seating and Safety Restraints* chapter for more information.
12.  **Driver cooled seat:** Press to control the driver cooled seat. Refer to *Heated and cooled seats* in the *Seating and Safety Restraints* chapter for more information.
13.  **Power/Driver temperature:** Press to activate/deactivate the climate control system. When the system is off, outside air is prevented from entering the vehicle. Turn to increase/decrease the air temperature on the driver side of the vehicle. The control also adjusts the passenger side temperature when PASS TEMP is disengaged. The recommended initial setting is between 72°F (22°C) and 75°F (24°C), then adjust for comfort. The driver side temperature setting will appear in the upper left corner of the display.
14.  – **Fan speed control:** Press to decrease the fan speed.
15. A.  **Rear defroster (if equipped):** Press to activate/deactivate the rear window defroster. Refer to *Rear window defroster* later in this chapter for more information. If your vehicle is equipped with both rear defroster and heated mirrors, the same button will activate both.
15. B.  **Heated mirrors (if equipped):** Press to activate/deactivate. This feature will remove ice and snow from the side view mirrors.

Climate Controls

DUAL ZONE AUTOMATIC TEMPERATURE CONTROL WITH HEATED AND COOLED SEATS (NAVIGATION BASED-IF EQUIPPED)





Temperature conversion: To switch between Fahrenheit and Celsius, refer to *Message center* in the *Driver Controls* chapter.

1. **CLIMATE:** Press to control the climate control system through the touch display screen. See *Touchscreen functions* later in this section.
2. A.  **Rear defroster (if equipped):** Press to activate/deactivate the rear window defroster. Refer to *Rear window defroster* later in this chapter for more information. If your vehicle is equipped with both rear defroster and heated mirrors, the same button will activate both.
 B.  **Heated mirrors (if equipped):** Press to activate/deactivate. This feature will remove ice and snow from the side view mirrors.
3. **A/C:** Press to activate/deactivate air conditioning. Use with recirculated air to improve cooling performance and efficiency. A/C engages automatically in MAX A/C,  (defrost) and  (floor/defrost).
4. **Passenger temperature:** Press to activate separate passenger temperature control to increase/decrease the air temperature on the passenger side of the vehicle.

Climate Controls

5.  **Passenger heated seat (if equipped):** Press to control the passenger heated seat. Refer to *Heated and cooled seats* in the *Seating and Safety Restraints* chapter for more information.

6.  **Passenger cooled seat (if equipped):** Press to control the passenger cooled seat. Refer to *Heated and cooled seats* in the *Seating and Safety Restraints* chapter for more information.

7.  **Recirculated air:** Press to activate/deactivate air recirculation in the vehicle. Recirculated air may reduce the amount of time needed to cool down the interior of the vehicle when used with A/C and may also help reduce undesired odors from reaching the interior of the vehicle. Recirculated air engages automatically when MAX A/C is selected or can be engaged manually in any airflow mode except  (defrost).

Recirculation may turn off automatically in all airflow selections except MAX A/C.

8. -  + **Fan speed control:** Press to decrease/increase the fan speed.

9. **AUTO:** Press to engage full automatic operation. Select the desired temperature using the temperature control. The system will automatically determine fan speed, airflow location, A/C on or off, and outside or recirculated air, to heat or cool the vehicle to reach the desired temperature.

10. **Driver temperature:** Press to increase/decrease the air temperature for the driver side of the vehicle. This control also adjusts the passenger side temperature when dual zone operation is disengaged.

11.  **Driver cooled seat (if equipped):** Press to control the driver cooled seat. Refer to *Heated and cooled seats* in the *Seating and Safety Restraints* chapter for more information.

12.  **Driver heated seat (if equipped):** Press to control the driver heated seat. Refer to *Heated and cooled seats* in the *Seating and Safety Restraints* chapter for more information.

13.  **Power:** Press to activate/deactivate the climate control system. When the system is off, outside air is prevented from entering the vehicle. The climate status in the touchscreen will also be turned off.

14.  **Defrost:** Distributes outside air through the windshield defroster vents and de-mister vents. Can be used to clear the windshield of fog and thin ice. The system will automatically provide outside air to reduce window fogging. Press this button again to return to the previous air flow selection.



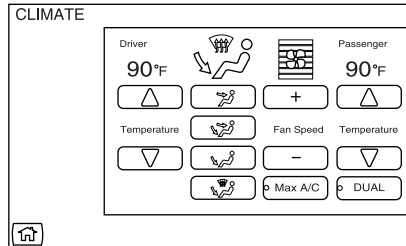

Climate Controls

TOUCHSCREEN FUNCTIONS



Temperature conversion: To switch between Fahrenheit and Celsius, refer to *Message center* in the *Driver Controls* chapter.

Temperature: Press the up and down arrows on the left side of the screen to increase/decrease the airflow temperature for the driver side of the vehicle. This control also adjusts the passenger side temperature when dual zone operation is disengaged. Press the up and down arrows on the right side of the screen to increase/decrease the airflow temperature for the passenger side of the vehicle.

-  : Distributes air through the instrument panel vents.
-  : Distributes air through the instrument panel vents, floor vents, rear seat floor vents and de-mister vents.
-  : Distributes air through the floor vents, rear seat floor vents.
-  : Distributes air through the windshield defroster vents, de-mister vents, floor vents and rear seat floor vents. The system will automatically provide outside air to reduce window fogging.

To return to full automatic control, press AUTO on the main bezel.

Fan Speed: Press to decrease/increase the fan speed.

Dual: Press to activate/deactivate separate driver and passenger temperature controls.



Max A/C: Distributes recirculated air through the instrument panel vents to cool the vehicle. This re-cooling of the interior air is more economical and efficient. Recirculated air may also help reduce undesirable odors from entering the vehicle. Press MAX A/C again for normal operation.

Climate Controls

VOICE COMMANDS IN CLIMATE MODE

Please refer to the *Voice commands in climate mode* section of the *Navigation supplement* for more information on using voice commands with the climate control system.



Operating tips

- To reduce fog build up on the windshield during humid weather, select  (defrost). Temperature and/or fan speed can also be increased to improve clearing.
- To reduce humidity build up inside the vehicle: do not drive with the system off or with  (recirculated air) engaged.
- Do not put objects under the front seats that will interfere with the airflow to the back seats.
- Remove any snow, ice or leaves from the air intake area at the base of the windshield.
- To improve the A/C cool down, drive with the windows slightly open for 2-3 minutes after start up or until the vehicle has been “aired out.”
- If you are driving during extreme high ambient temperatures and idling for extended periods of time in gear, it is recommended to run the A/C in the MAX A/C mode, adjust the blower fan speed to the lowest setting and put the vehicle’s transmission in P (Park) to continue to receive cool air from your A/C system.

For maximum cooling performance MAX A/C in AUTO:

1. Press AUTO control.
2. Set to desired temperature.

For maximum cooling performance MAX A/C in manual override control

1. Choose  (panel), A/C, and  (recirculation) controls.
2. Set the temperature to 60°F (16°C).
3. Set the fan to the highest blower setting.

To aid in side window defogging/demisting in cold weather:

1. Select .
2. Select A/C.
3. Adjust the temperature control to maintain comfort.
4. Set the fan speed to the highest setting.

Climate Controls

5. Direct the outer instrument panel vents towards the side windows.

To increase airflow to the outer instrument panel vents, close the vents located in the middle of the instrument panel.

REAR WINDOW DEFROSTER (IF EQUIPPED)



The rear defroster control is located on the climate control panel and works to defrost your rear window from fog and thin ice. If equipped, it also operates the heated mirror to remove snow and thin ice from the side mirrors.

Ensure that the ignition on. Press to turn the defroster on/off. The indicator light will illuminate when activated.

Do not use razor blades or other sharp objects to clean the inside of the rear window or to remove decals from the inside of the rear window. This may cause damage to the heated grid lines and will not be covered by your warranty.

Lights

HEADLAMP CONTROL ☀

Rotate the headlamp control clockwise to the first position  to turn on the parking lamps. Rotate clockwise to the second position  to also turn on the headlamps.

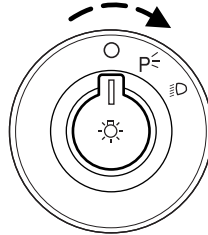



Autolamp control (if equipped) ☀

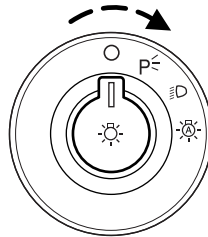

The autolamp system provides light sensitive automatic on-off control of the exterior lights normally controlled by the headlamp control.

The autolamp system also keeps the lights on for approximately 20 seconds or, on vehicles equipped with a message center, you can select a delay from 0–180 seconds, after the ignition switch is turned to off.



- To turn autolamps on, rotate the control to  .
- To turn autolamps off, rotate the control to  .

If your vehicle is not equipped with a message center, then the auto lamps can be programmed manually by:

1. Start with the ignition in off and the autolamps  selected.
2. Turn off the autolamps by turning the headlamp switch to  .
3. Turn the ignition to on.
4. Turn the ignition to off.
5. Select the autolamps by turning the headlamp switch to  .



Steps 2 through 5 must be performed within a 10 second period. At this point, the headlamps and park lamps will turn on.

6. Deselect the autolamps after the desired autolamp delay time (maximum of three minutes).

Lights

At this point, the headlamps and park lamps will turn off.

Fog lamp control (if equipped)

The headlamp control also operates the fog lamps. The fog lamps can be turned on only when the headlamp control is in the ,  or  position and the high beams are not turned on.

Pull headlamp control towards you to turn fog lamps on. The fog lamp indicator light  will illuminate.

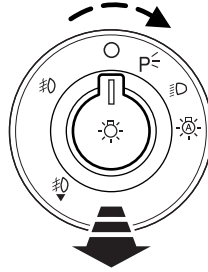

High beams

Push the lever toward the instrument panel to activate. Pull the lever towards you to deactivate.

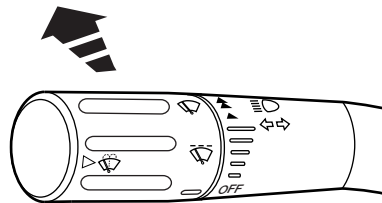

Flash to pass

Pull toward you slightly to activate and release to deactivate.

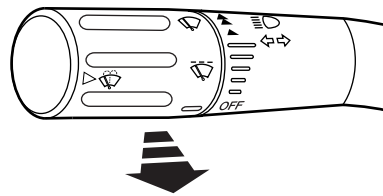

Lights

Daytime running lamps (DRL) (if equipped)

Turns the headlamps on with a reduced output.

In order for the DRLs to function:

- the ignition must be in the on position and
- the headlamp control is in the , parking lamp or autolamp position.



WARNING: Always remember to turn on your headlamps at dusk or during inclement weather. The Daytime Running Lamp (DRL) system does not activate the tail lamps and generally may not provide adequate lighting during these conditions. Failure to activate your headlamps under these conditions may result in a collision.

PANEL DIMMER CONTROL

Use to adjust the brightness of the instrument panel when exterior lights are on.

- Rotate the thumbwheel from left to right to brighten the instrument panel.
- Rotate the thumbwheel from right to left to dim the instrument panel.
- Rotate fully to the right (past detent) to turn on interior lamps.
- Rotate to the left position (past detent) to turn off the interior lamps and to disable the illuminated entry feature. When the control is in the far left position, it acts as a dome lamp defeat/override.

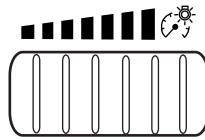

Note: If the battery is disconnected, discharged, or a new battery is installed, the dimmer switch requires re-calibration. Rotate the dimmer switch from the full dim position to the full dome/on position to reset. This will ensure that your displays are visible under all lighting conditions.

AIMING THE HEADLAMPS

The headlamps on your vehicle are properly aimed at the assembly plant. If your vehicle has been in an accident, the alignment of your headlamps should be checked by your authorized dealer.

Lights

Vertical aim adjustment

1. Park the vehicle directly in front of a wall or screen on a level surface, approximately 25 feet (7.6 meters) away.

- (1) 8 feet (2.4 meters)
- (2) Center height of lamp to ground
- (3) 25 feet (7.6 meters)
- (4) Horizontal reference line

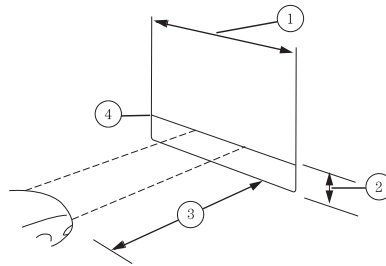

2. Measure the height from the center of your headlamp (indicated by a 3.0 mm circle on the lens) to the ground and mark an 8 foot (2.4 meter) horizontal reference line on the vertical wall or screen at this height (a piece of masking tape works well).

3. Turn on the low beam headlamps to illuminate the wall or screen and open the hood. Cover one of the headlamps so no light hits the wall.

4. On the wall or screen you will observe a light pattern with a distinct horizontal edge towards the right. If this edge is not at the horizontal reference line, the beam will need to be adjusted so the edge is at the same height as the horizontal reference line.

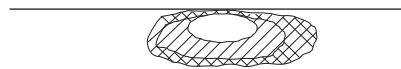

5. Locate the vertical adjuster on each headlamp, then use a P2 Philips screwdriver to turn the adjuster either counterclockwise (to adjust down) or clockwise (to adjust up) aligning the upper edge of the light pattern up to the horizontal line.

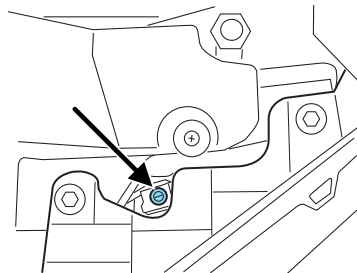

6. HORIZONTAL AIM IS NOT REQUIRED FOR THIS VEHICLE AND IS NON-ADJUSTABLE.

7. Repeat Steps 3–5 for the other headlamp.

8. Close the hood and turn off the lamps.

Lights

TURN SIGNAL CONTROL ⇐⇒

- Push down to activate the left turn signal.
- Push up to activate the right turn signal.

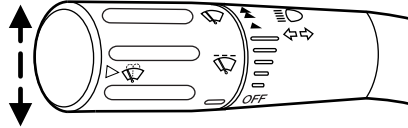

INTERIOR LAMPS



Front row map lamps (if equipped)

To turn on the map lamps, press the outer edge of the clear lens. The front row map lamp lights when:

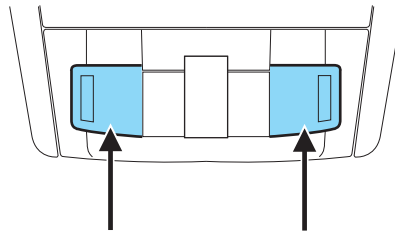
- any door is opened.
- the instrument panel dimmer switch is rotated until the courtesy lamps come on.
- the remote entry controls are pressed and the ignition is off.



Rear dome lamp (if equipped)

- ON or  : The dome light will stay on.
- DOOR or middle position: The dome light will only come on if a door is opened.
- OFF or  : The lamp will not come on at all.

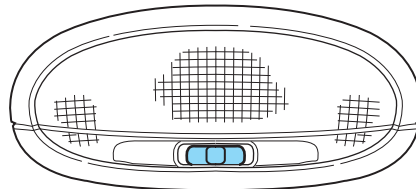

The rear dome lamp can be turned on or off by sliding the control.

Lights

Rear dome/courtesy lamps (if equipped)

The dome lamp lights when:

- any door is opened.
- the instrument panel dimmer switch is rotated up until the courtesy lamps come on.
- any of the remote entry controls are pressed and the ignition is off.

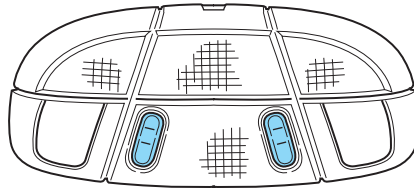

The reading portion, the two outer lights, can only be turned on and off at the lamp.

Rear courtesy/reading/cargo lamps (if equipped)

The dome portion of the lamp, the center light, can be turned on when the panel dimmer control is rotated until the lamps come on or when any door is opened.

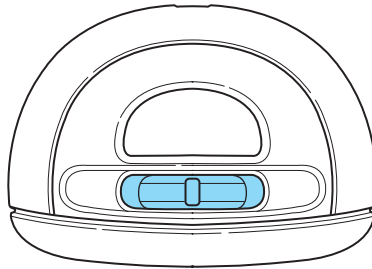

With the ignition key in the accessory or on position, the rear dome lamp can be turned on or off by sliding the control.

BULB REPLACEMENT

Lamp assembly condensation

Exterior lamps are vented to accommodate normal changes in pressure. Condensation can be a natural by-product of this design. When moist air enters the lamp assembly through the vents, there is a possibility that condensation can occur when the temperature is cold. When normal condensation occurs, a thin film of mist can form on the interior of the lens. The thin mist eventually clears and exits through the vents during normal operation. Clearing time may take as long as 48 hours under dry weather conditions.

Examples of acceptable condensation are:

- Presence of thin mist (no streaks, drip marks or droplets)
- Fine mist covers less than 50% of the lens

Lights

Examples of unacceptable moisture (usually caused by a lamp water leak) are:

- Water puddle inside the lamp
- Large water droplets, drip marks or streaks present on the interior of the lens

Take your vehicle to dealer for service if any of the above conditions of unacceptable moisture are present.

Using the right bulbs

Replacement bulbs are specified in the chart below. Headlamp bulbs must be marked with an authorized "D.O.T." for North America and an "E" for Europe to ensure lamp performance, light brightness and pattern and safe visibility. The correct bulbs will not damage the lamp assembly or void the lamp assembly warranty and will provide quality bulb burn time.

Function	Number of bulbs	Trade number
Headlamps	2	H13/9008
Front park/turn lamps	2	3157NA (natural amber)
Front sidemarker	2	168
Fog lamps	2	9140
Backup lamp (styleside)	2	921
Backup lamp (flareside)	2	3156
Rear stop/turn/sidemarker/tail lamp (styleside)	4	4057K
Rear stop/turn/sidemarker/tail lamp (flareside)	2	3057K
High-mount brakelamp	1	912
Cargo lamp	2	912
License plate lamp	2	194
Exterior mounted mirror turn signal indicator (if equipped)	2	See your dealer
Puddle lamp (if equipped)	2	See your dealer
All replacement bulbs are clear in color except where noted.		
To replace all instrument panel lights - see your authorized dealer		

Replacing exterior bulbs

Check the operation of all the bulbs frequently.

Replacing headlamp bulbs

1. Make sure that the headlamp control is in the off position and open the hood.

2. Remove the pushpin that holds the air deflector/protective cover from the upper inboard corner of the lamp.

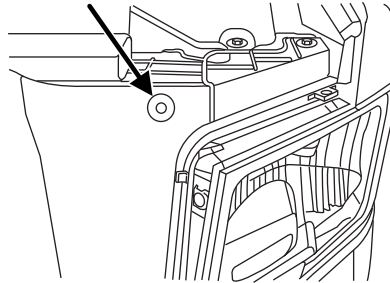

3. Loosen the three retaining screws (two at top of lamp, one at lower inboard corner).

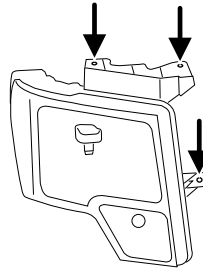

4. Once the three retaining screws have been removed, slide the headlamp assembly forward, disconnecting the two snap attachments at the fender.

5. Disconnect the electrical connector from the bulb by pulling rearward.

Lights

6. Remove the bulb and socket by turning it counterclockwise, then pull it straight out.

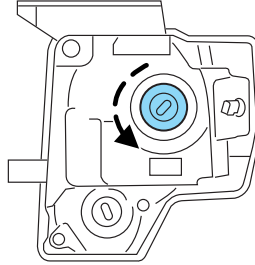

WARNING: Handle a halogen headlamp bulb carefully and keep out of children's reach. Grasp the bulb only by its plastic base and do not touch the glass. The oil from your hand could cause the bulb to break the next time the headlamps are operated.

Install the new bulb in reverse order.

Replacing front parking lamp/turn signal/sidemarkers bulbs

1. Make sure that the headlamp control is in the off position and open the hood.
2. Remove the pushpin that holds the air deflector/protective cover from the upper inboard corner of the lamp.
3. Loosen the three retaining screws (two at top of lamp, one at lower inboard corner).
4. Once the three retaining screws have been removed, slide the headlamp assembly forward, disconnecting the two snap attachments at the fender.
5. Disconnect the electrical connector from the bulb by pulling rearward.

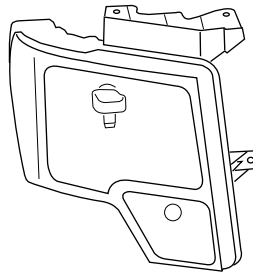

Lights

6. Remove the bulb and socket by turning it counterclockwise, then pull it straight out.

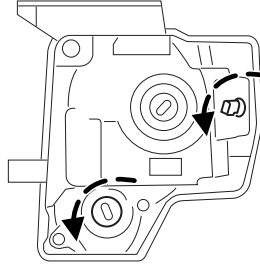

Install the new bulb(s) in reverse order.

Replacing tail/brake/turn signal/backup lamp bulbs

1. Make sure the headlamp control is in the off position.
2. Open the tailgate to expose the lamp assembly and remove the two bolts from the tail lamp assembly.

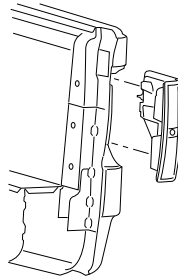

3. Carefully pull the lamp assembly straight rearward from the tailgate pillar to disengage two hidden snap-in retainers. (Flare side tail lamps are not equipped with snap-in retainers.)

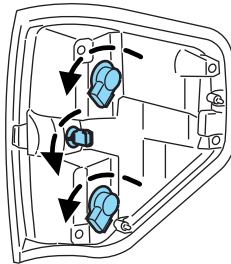

4. Remove bulb socket from the lamp assembly by turning it counterclockwise.
5. Pull bulb straight out of socket and press in the new bulb.

Install the new bulb(s) in reverse order.

Lights

Replacing high-mount brake and cargo lamp bulbs

Make sure the headlamp control is in the off position.

1. Remove the two screws and move the lamp assembly away from the vehicle to expose the bulb sockets.
2. Remove the bulb socket by rotating counterclockwise and pulling it out of the lamp assembly.
3. Pull the bulb straight out of the socket and push in the new bulb.

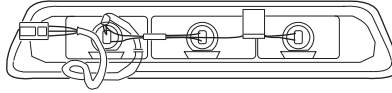

Install the new bulbs in reverse order.

Replacing fog lamp bulbs (if equipped)

1. Make sure the headlamp control is in the off position.
2. Remove the bulb socket from the fog lamp by turning counterclockwise.
3. Disconnect the electrical connector from the fog lamp bulb.

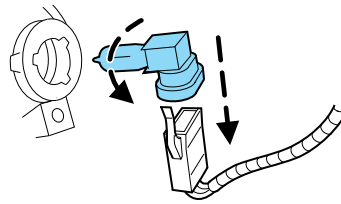

Install the new bulb in reverse order.

Replacing exterior mounted mirror turn signal indicator lamp bulbs

For bulb replacement, see your authorized dealer.

Replacing license plate lamp bulbs

The license plate bulbs are located behind the rear bumper. To change the license plate lamp bulbs:

1. Reach behind the rear bumper to locate the bulb.
2. Twist the bulb socket counterclockwise and carefully pull to remove it from the lamp assembly.
3. Pull out the old bulb from the socket and push in the new bulb.
4. Install the bulb socket in lamp assembly by turning it clockwise.

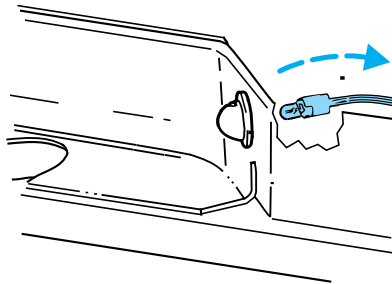

Driver Controls

MULTI-FUNCTION LEVER

Windshield wiper: Rotate the end of the control away from you to increase the speed of the wipers; rotate towards you to decrease the speed of the wipers.

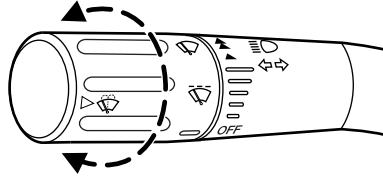

Rain sensing wipers (if equipped): The rain sensing wipers will automatically activate when moisture is present on the windshield and the multi-function switch is set to one of five auto/interval sensitivity settings. The wipers will continue to wipe as long as the presence of moisture is detected on the windshield. The speed of the rain sensing wipers will vary based on the amount of moisture detected on the windshield and the auto/interval setting. The speed is automatically increased at night.

Note: The rain sensing wiper feature must be turned off before entering a car wash. Rotate the end of the control to the OFF position.

Windshield washer: Push the end of the stalk:

- briefly: causes a single swipe of the wipers without washer fluid.
- a quick push and hold: the wipers will swipe three times with washer fluid.
- a long push and hold: the wipers and washer fluid will be activated for up to ten seconds.

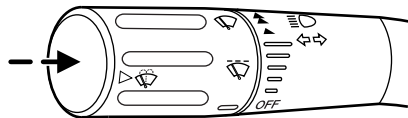

Courtesy wipe feature: One extra wipe will occur a few seconds after washing the front window to clear any excess washer fluid remaining on the windshield.

Note: Do not operate the washer when the washer reservoir is empty. This may cause the washer pump to overheat. Check the washer fluid level frequently. Do not operate the wipers when the windshield is dry. This may scratch the glass, damage the wiper blades and cause the wiper

Driver Controls

motor to burn out. Before operating the wiper on a dry windshield, always use the windshield washer. In freezing weather, be sure the wiper blades are not frozen to the windshield before operating the wipers.

TILT STEERING WHEEL (IF EQUIPPED)

1. Pull and hold the steering wheel release control toward you.
2. Move the steering up or down until you find the desired location.
3. Release the steering wheel release control. This will lock the steering wheel in position.

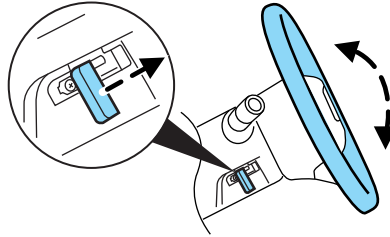

WARNING: Never adjust the steering column when the vehicle is moving.

POWER TILT STEERING (IF EQUIPPED)

The steering column can be adjusted manually by moving the two-way rocker adjustment control located below the turn signal/wiper control stalk. Hold the control to adjust.

The tilt function is adjusted by depressing the control up or down.

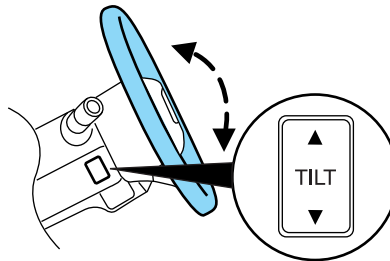

Easy entry/exit feature

When you remove the key from the ignition, the column will move to the full up position if this feature is activated through the message center. Refer to the *Message center* in the *Driver Controls* chapter. When the key is inserted into the ignition, the column will return to the previous setting.

Note: The easy entry/exit feature will prevent the steering wheel from returning to the memory position until the key is inserted into the ignition.

Driver Controls

Memory feature

The steering column positions are saved when doing a memory set function and can be recalled along with the vehicle personality features when a memory position is selected through the remote entry transmitter, keyless entry keypad or memory switch on the side of the driver's seat (if equipped with memory feature). Refer to *Memory seat/power mirrors/adjustable pedals* in the *Seating and Safety Restraints* chapter.

If the steering column adjustment control is pressed during memory recall it will cancel the automatic operation and the column will respond to manual adjustment of the control.



WARNING: Never adjust the steering column when the vehicle is moving.

On vehicles with memory feature, to prevent damage to the steering column, the steering column is designed to set a stopping position just short of the end of the column position. If the steering column encounters an object while moving up or down, a new stopping position will be set. To reset the steering column to its normal stopping position:

- After encountering the new stopping position, press the steering column control again to override.
- Continue pressing the control until it reaches the end of the column position.
- Continue pressing the control for approximately two seconds. You will feel the steering column bounce back slightly.

ILLUMINATED VISOR MIRROR (IF EQUIPPED)

Lift the mirror cover to turn on the visor mirror lamp.

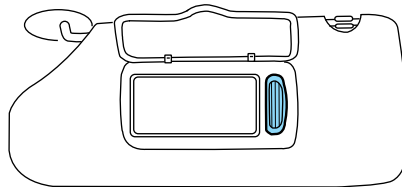

Driver Controls

CENTER CONSOLE (IF EQUIPPED)

The center console offers several useful storage features. These include:

1. Cupholders
2. Tissue holder in lid
3. Power point
4. Large utility compartment has coin holder slots and a cardholder located inside on the passenger side and a pen holder on the lid.

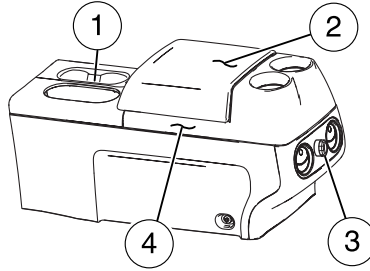

WARNING: Use only soft cups in the cupholder. Hard objects can injure you in a collision.

ELECTRONIC COMPASS (IF EQUIPPED)

The compass heading is displayed as one of N, NE, E, SE, S, SW, W and NW in the Center Integrated Display (CID).

The compass reading may be affected when you drive near large buildings, bridges, power lines and powerful broadcast antenna. Magnetic or metallic objects placed in, on or near the vehicle may also affect compass accuracy.

Usually, when something affects the compass readings, the compass will correct itself after a few days of operating your vehicle in normal conditions. If the compass still appears to be inaccurate, a manual calibration may be necessary. Refer to *Compass calibration adjustment*.

Most geographic areas (zones) have a magnetic north compass point that varies slightly from the northerly direction on maps. This variation is four degrees between adjacent zones and will become noticeable as the vehicle crosses multiple zones. A correct zone setting will eliminate this error. Refer to *Compass zone adjustment*.

Driver Controls

Compass zone adjustment

1. Determine which magnetic zone you are in for your geographic location by referring to the zone map.
2. Turn ignition to the on position.

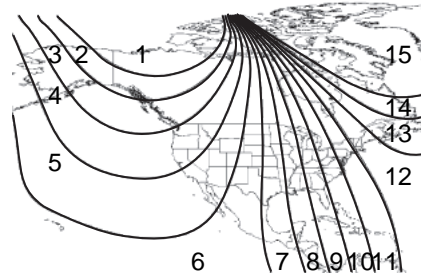

3. Press and hold the 7 and 9 radio preset buttons together for approximately five seconds until ZONE XX appears in the CID.

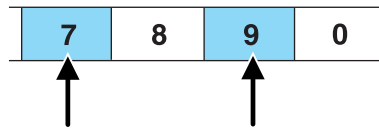

4. Press and release the 7 and 9 radio preset buttons together, repeatedly until ZONE XX changes to the correct zone (1–15) in the CID.

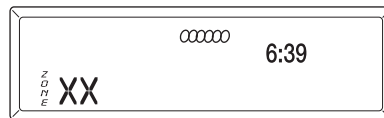

5. The direction will display after the buttons are released. The zone is now updated.

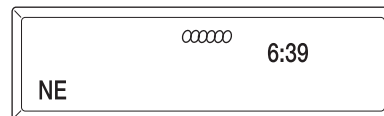

Compass calibration adjustment

Perform compass calibration in an open area free from steel structures and high voltage lines. For optimum calibration, turn off all electrical accessories (heater/air conditioning, wipers, etc.) and make sure all vehicle doors are shut.

1. Start the vehicle.

Driver Controls

2. To calibrate, press and hold the 7 and 9 radio preset buttons together for approximately 10 seconds until CAL appears. Release the buttons.

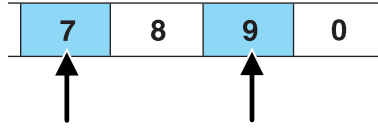

3. Slowly drive the vehicle in a circle (less than 3 mph [5 km/h]) until the CAL display changes to the direction value (N, S, E, W, etc.). It may take up to five circles to complete calibration.

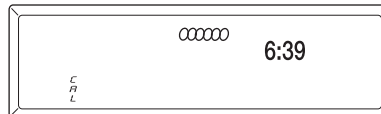

4. The compass is now calibrated.

AUXILIARY POWER POINT (12VDC)

Power outlets are designed for accessory plugs only. Do not insert any other object in the power outlet as this will damage the outlet and blow the fuse. Do not hang any type of accessory or accessory bracket from the plug. Improper use of the power outlet can cause damage not covered by your warranty.

The auxiliary power point is located on the instrument panel.

Do not use the power point for operating the cigarette lighter element (if equipped).

To prevent the fuse from being blown, do not use the power point(s) over the vehicle capacity of 12 VDC/180W. If the power point or cigar lighter socket is not working, a fuse may have blown. Refer to *Fuses and relays* in the *Roadside Emergencies* chapter for information on checking and replacing fuses.

To have full capacity usage of your power point, the engine is required to be running to avoid unintentional discharge of the battery. To prevent the battery from being discharged:

- do not use the power point longer than necessary when the engine is not running,
- do not leave battery chargers, video game adapters, computers and other devices plugged in overnight or when the vehicle is parked for extended periods.

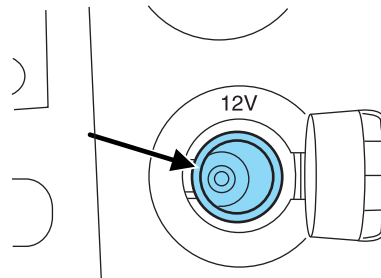

Driver Controls

An additional auxiliary power point is located on the lower rear side of the center console. The power point is accessible from the rear seats.

Always keep the power point caps closed when not being used.

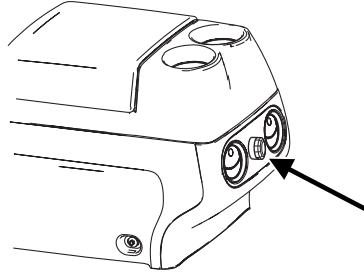

Cigarette/Cigar lighter (if equipped)

Do not plug optional electrical accessories into the cigarette lighter socket.

Do not hold the lighter in with your hand while it is heating, this will damage the lighter element and socket. The lighter will be released from its heating position when it is ready to be used.

Note: Improper use of the lighter can cause damage not covered by your warranty, and can result in fire or serious injury.

Cupholder/Ashtray (if equipped)

The cupholder/ashtray is located on the instrument panel.

To open cupholder/ashtray, push in on the door and release. The door will spring out 1/4+ inches. Then pull cupholder/ashtray assembly out the remaining distance to utilize. To close, push assembly in completely and release.

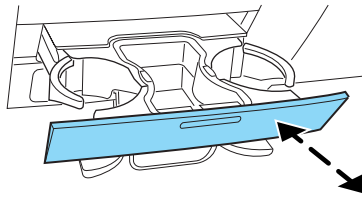

Driver Controls

Ashtray (if equipped)

The ashtray is located on the instrument panel.

To open ashtray, push in on the door and release. The ashtray assembly will tip out. To close, push assembly in completely and release.

Up-level ashtray shown; base similar.

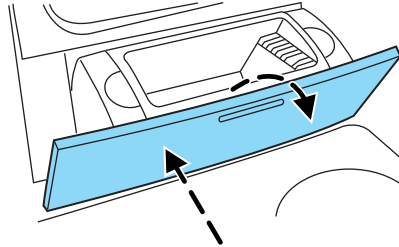

POWER WINDOWS



WARNING: Do not leave children unattended in the vehicle and do not let children play with the power windows. They may seriously injure themselves.



WARNING: When closing the power windows, you should verify they are free of obstructions and ensure that children and/or pets are not in the proximity of the window openings.

Press and pull the window switches to open and close windows.

- Push down (to the first detent) and hold the switch to open.
- Pull up (to the first detent) and hold the switch to close.

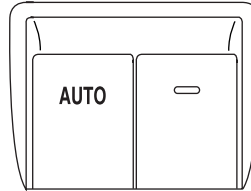

Rear Window Buffeting: When one or both of the rear windows are open, the vehicle may demonstrate a wind throb or buffeting noise. This noise can be alleviated by lowering a front window approximately two to three inches.

Driver Controls

One touch down

Allows the driver's window to open fully without holding the control down. Press the switch completely down to the second detent and release quickly. The window will open fully. Momentarily press the switch to any position to stop the window operation.

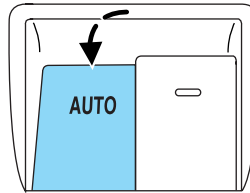

Window lock

The window lock feature allows only the driver to operate the power windows.

To lock out all the window controls (except for the driver's) press the right side of the control. Press the left side to restore the window controls.

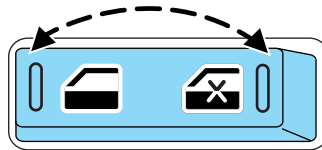

Note: The rear window switches will not illuminate when the window control is in the locked position.

Power sliding back window (if equipped)

Press and hold the  the control to open the window all the way to the full open position.

Pull and hold the  control to close the window.

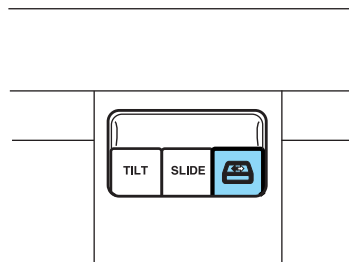

WARNING: When operating the power sliding back window you must ensure all rear seat occupants and/or cargo are not in the proximity of the back window.

Driver Controls



WARNING: Do not leave children unattended in the vehicle and do not let children play with the power sliding back window. They may seriously injure themselves.

Accessory delay (if equipped)

With accessory delay, the window switches may be used for up to 10 minutes after the ignition switch is turned to the off position or until any door is opened.

INTERIOR MIRROR

The interior rear view mirror has two pivot points on the support arm which lets you adjust the mirror up or down and from side to side.



WARNING: Do not adjust the mirror while the vehicle is in motion.

Automatic dimming interior rear view mirror (if equipped)

Your vehicle may be equipped with an interior rear view mirror that has an auto-dimming function (optional on the driver's side exterior mirror). The electronic day/night mirror will change from the normal (high reflective) state to the non-glare (darkened) state when bright lights (glare) reach the interior mirror. When the interior mirror detects bright light from behind the vehicle, the interior rear view mirror and the driver's side exterior mirror (if equipped) will automatically adjust (darken) to minimize glare.

Without microphone

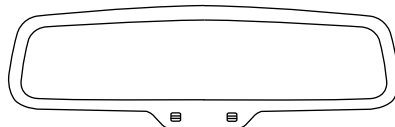

Driver Controls

With microphone

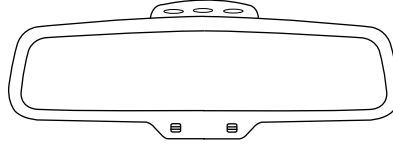

The mirrors will automatically return to the normal state whenever the vehicle is placed in R (Reverse) to ensure a bright clear view when backing up.

Do not block the sensors on the front and back of the interior rear view mirror since this may impair proper mirror performance.

Do not clean the housing or glass of any mirror with harsh abrasives, fuel or other petroleum-based cleaning products.

Note: If equipped with a reverse camera system, a video image will display in the mirror or the Navigation system display (if equipped) when the vehicle is put in R (Reverse). As you shift into any other gear from R (Reverse), the image will remain for a few seconds and then turn off. Refer to *Reverse camera system* in the *Driving* chapter.

EXTERIOR MIRRORS

Power side view mirrors (if equipped)



WARNING: Do not adjust the mirror while the vehicle is in motion.

To adjust your mirrors:

1. Rotate the control clockwise to adjust the right mirror and rotate the control counterclockwise to adjust the left mirror.
2. Move the control in the direction you wish to tilt the mirror.
3. Return to the center position to lock mirrors in place.



Memory feature (if equipped)

The power side view mirror positions are saved when doing a memory set function and can be recalled along with the vehicle personality features when a memory position is selected through the remote entry

Driver Controls

transmitter, keyless entry keypad or memory switch on the driver's seat. Refer to *Memory seats and mirrors* in the *Seating and Safety Restraints* chapter.

Automatic dimming feature (if equipped)

The driver's side view mirror has an auto-dimming function. For more information, refer to *Automatic dimming interior rear view mirror* in this chapter.

Fold-away mirrors

Fold the side mirrors in carefully before driving through a narrow space, like an automatic car wash.

Powerfold mirrors (if equipped)

With powerfold mirrors, you can fold the side mirrors using the power mirror switch.

1. Rotate the switch to the center/neutral position.
2. Momentarily pull the switch rearward to auto fold in.
3. Momentarily pull the switch rearward again to fold back to design position.

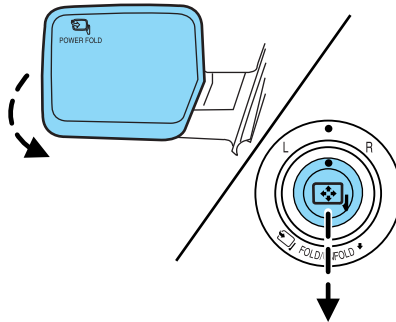

The powerfold mirrors may be moved inward/outward manually. However, if a mirror is moved manually, it will need to be reset. A mirror which has not been reset may appear to be loose. To reset: with the switch in the center position, momentarily pull the switch rearward to fold the mirrors in. An audible "click" will be heard indicating re-synchronization. If the click is not heard, use the switch to fold the mirrors out, then in, until the click is heard. After that, the mirrors will operate normally until they are again moved manually.

Note: 10 or more switch activations within one minute, or repeated folding/unfolding of the mirrors while holding the switch rearward during full travel, may cause the system to disable the fold/unfold function to protect motors from overheating. Should this occur, wait approximately three minutes with the vehicle running and up to 10 minutes with the vehicle off, for the system to reset and for function to return to normal.

Driver Controls

Heated outside mirrors (if equipped)

Heated mirrors remove ice, mist and fog. To activate the heated mirrors, press the rear defrost button  located on the climate control panel.

Refer to *Rear window defroster* in the *Climate Controls* chapter for more information.

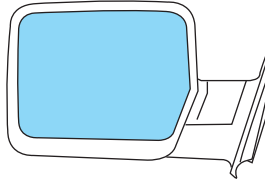

On vehicles not equipped with rear defrost, press the heated mirror control  located on the climate control panel. For more information refer to the *Climate Controls* chapter.

Note: If your vehicle is equipped with the Auto dimming feature, the mirror glass is thicker and will take longer to defrost.

Do not remove ice from the mirrors with a scraper or attempt to readjust the mirror glass if it is frozen in place. These actions could cause damage to the glass and mirrors.

Do not clean the housing or glass of any mirror with harsh abrasives, fuel or other petroleum-based cleaning products.

Exterior mounted mirror turn signal indicator (if equipped)

When the vehicle turn signal is activated, the lower portion of the mirror housing will blink.

This feature provides an indicator to the driver that the vehicle turn signal is working properly.

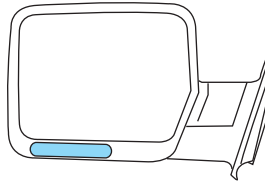

Driver Controls

Telescoping trailer tow mirrors (if equipped)

The telescoping feature allows the mirror to extend approximately 3.5 inches (90 mm). This feature is especially useful to the driver when towing a trailer. Pull the mirrors inward carefully when driving through a narrow space.

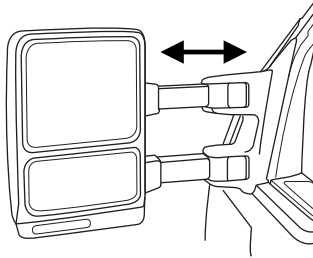

POWER ADJUSTABLE FOOT PEDALS (IF EQUIPPED)

The accelerator and brake pedal should only be adjusted when the vehicle is stopped and the gearshift lever is in the P (Park) position.

Press and hold the rocker control to adjust accelerator and brake pedal.

- Press the right side of the control to adjust the pedals toward you.
- Press the left side of the control to adjust the pedals away from you.

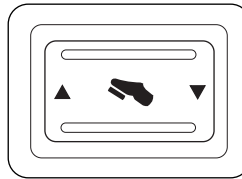

WARNING: Never adjust the accelerator and brake pedal with feet on the pedals while the vehicle is moving.

POWER DEPLOYABLE RUNNING BOARDS (IF EQUIPPED)

Deployable running boards (DRB) automatically move when the doors are opened to assist entering and exiting the vehicle.

Driver Controls

Automatic power deploy:

- The running boards will extend down and out when the doors are opened.

Automatic power stow:

- The running boards will return to the stowed position when the doors are closed. There will be a two second delay before the running boards move in to the stowed position.

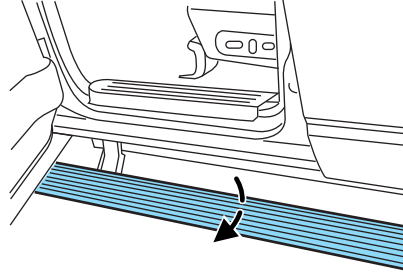

Manual power deploy:

To manually operate the running boards, refer to the *Message center* in this chapter.

- This feature can manually set the running boards in the deployed position for access to the roof.
- When running boards are manually set in the deployed position <OUT>, the boards will return to the stowed position and enter automatic mode when the vehicle speed exceeds 5 mph (8 km/h).

Enable/disable:

To enable/disable the power running board feature, refer to the *Message center* in this chapter.

- When this feature is disabled <OFF>, the running boards will move to the stowed position regardless of the position of the doors.
- When this feature is enabled <AUTO>, the running boards will move back to the correct positions based off of the door positions.

Bounce-back:

- If an object is in the way of the moving running board, the running board will automatically bounce back in the reverse direction and move to the end of travel.

Note: The running boards may operate slower in cooler temperatures. In adverse conditions, debris such as mud, dirt, and salt may become trapped in the running board mechanism, possibly leading to unwanted noise. If this occurs, manually set the running boards to the deployed position <OUT> and flush the system (in particular the front and rear hinge arms) with a high-pressure car wash wand.

Driver Controls

Note: Do not use the running boards, front and rear hinge assemblies, running board motors, or the running board under body mounts to lift the vehicle when jacking. Please utilize proper jacking points. Refer to *Changing the tires* in the *Roadside Emergencies* chapter.

 **WARNING:** In extreme climates, excessive ice buildup may occur, causing the running boards not to deploy. Be sure that the running boards have deployed, and have finished moving before attempting to step on them. Note: The running boards will resume normal function once the blockage is cleared.

 **WARNING:** Turn off the running boards before jacking or placing any object under the vehicle. Never place your hand between the extended running board and the vehicle. A moving running board may cause injury.

SPEED CONTROL (IF EQUIPPED)

With speed control set, you can maintain a set speed without keeping your foot on the accelerator pedal.

 **WARNING:** Do not use the speed control in heavy traffic or on roads that are winding, slippery or unpaved.

Setting speed control

The controls for using your speed control are located on the steering wheel for your convenience.

1. Press the ON control and release it.
2. Accelerate to the desired speed.

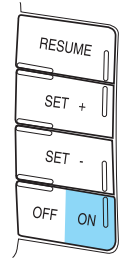

Driver Controls

3. Press the SET + or SET - control and release it.
4. Take your foot off the accelerator pedal.
5. The indicator  light on the instrument cluster will turn on.

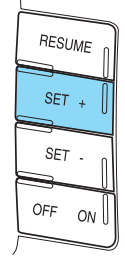

Note:

- Vehicle speed may vary momentarily when driving up and down a steep hill.
- If the vehicle speed increases above the set speed on a downhill, you may want to apply the brakes to reduce the speed.
- If the vehicle speed decreases more than 10 mph (16 km/h) below your set speed on an uphill, your speed control will disengage.

Disengaging speed control

To disengage the speed control:

- Depress the brake pedal.

Disengaging the speed control will not erase previous set speed.

Resuming a set speed

Press the RESUME control and release it. This will automatically return the vehicle to the previously set speed.

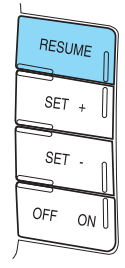

Driver Controls

Increasing speed while using speed control

There are two ways to set a higher speed:

- Press and hold the SET + control until you get to the desired speed, then release the control. You can also use the SET + control to operate the Tap-Up function. Press and release this control to increase the vehicle set speed in small amounts by 1 mph (1.6 km/h).
- Use the accelerator pedal to get to the desired speed. When the vehicle reaches that speed press and release the SET + control.

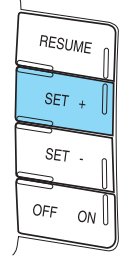

Reducing speed while using speed control

There are two ways to reduce a set speed:

- Press and hold the SET - control until you get to the desired speed, then release the control. You can also use the SET - control to operate the Tap-Down function. Press and release this control to decrease the vehicle set speed in small amounts by 1 mph (1.6 km/h).
- Depress the brake pedal until the desired vehicle speed is reached and press the SET + control.

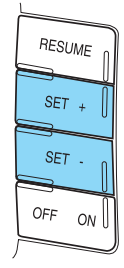

Driver Controls

Turning off speed control

There are two ways to turn off the speed control:

- Depress the brake pedal or the clutch pedal (if equipped). This will not erase your vehicle's previously set speed.
- Press the speed control OFF control.

Note: When you turn off the speed control or the ignition, your speed control set speed memory is erased.

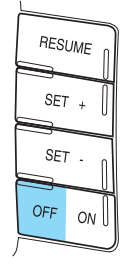

STEERING WHEEL CONTROLS (IF EQUIPPED)

Radio control features

Press MEDIA to select:

- AM, FM1, FM2, or CD
- SAT1, SAT2 or SAT3 (Satellite Radio mode).
- LINE IN (auxiliary input jack)

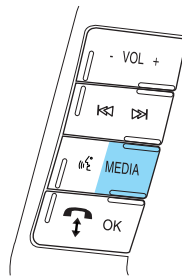

In radio mode:

- Press **◀▶** to access the next/previous preset station.

In CD mode:

- Press **◀▶** to listen to the next track on the disc.

In satellite radio mode:

- Press **◀▶** to advance through preset channels.

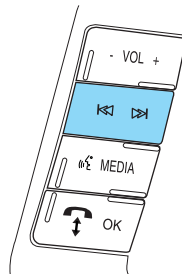



Driver Controls

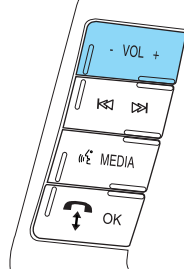

In any mode:

- Press VOL + or VOL - to adjust the volume.



SYNC® system hands free control features

Press  briefly to use the voice command feature. You will hear a tone and LISTENING will appear in the radio display. Press and hold  to exit voice command.

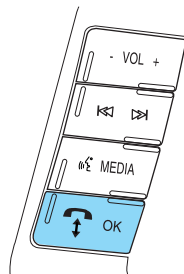

Press  to activate phone mode or answer a phone call. Press VOL + or - to adjust volume. Press and hold  to end a call or exit phone mode.





Press  to scroll through various menus and selections. Press OK to confirm your selection.

For further information on the SYNC® system, refer to the SYNC® supplement.

Navigation system/SYNC® hands free control features (if equipped)

Press  control briefly until the voice  icon appears on the Navigation display to use the voice command feature.

Press  to activate phone mode or answer a phone call. Press VOL + or - to adjust volume. Press and hold  to exit phone mode or end a call.

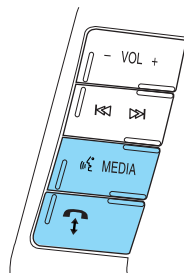

Driver Controls

For further information on the Navigation system/SYNC® system, refer to the *Navigation* and *SYNC®* supplements.

MOON ROOF (IF EQUIPPED)

The moon roof control is located on the overhead console.



WARNING: Do not let children play with the moon roof or leave children unattended in the vehicle. They may seriously hurt themselves.



WARNING: When closing the moon roof, you should verify that it is free of obstructions and ensure that children and/or pets are not in the proximity of the moon roof opening.

The moon roof is equipped with an automatic, one-touch, express opening and closing feature. To stop motion at any time during the one-touch operation, press the control a second time.

To open the moon roof: Press and release the SLIDE control, the moon roof will open automatically. Press the switch again to stop the moon roof.

To close the moon roof: Pull and release the SLIDE control, the moon roof will close automatically. Press the switch again to stop the moon roof.

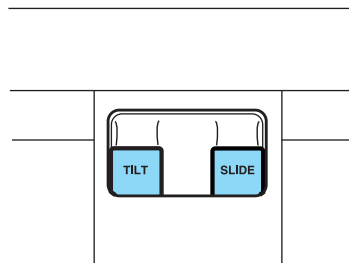

Bounce-back: When an obstacle has been detected in the moon roof opening as the moon roof is closing, the moon roof will automatically open and stop at a prescribed position.

Bounce-back override: To override bounce-back function, pull and hold the SLIDE switch within two seconds of a bounce-back event. The closing force will begin to increase each time the moon roof is closed for the first three closing cycles, with bounce-back active. For example: Bounce-back can be used to overcome the resistance of ice on the moon roof or seals

To vent the moon roof: Press and release the TILT control, the moon roof will move to the vent position automatically from any moon roof position. Press the switch again to stop the moon roof. Pull and hold the TILT control to close the moon roof.

Driver Controls

The moon roof has a built-in sliding shade that can be manually opened or closed when the glass panel is shut. To close the shade, pull it toward the front of the vehicle.

HOMELINK® WIRELESS CONTROL SYSTEM (IF EQUIPPED)

The HomeLink® Wireless Control System, located on the driver's visor, provides a convenient way to replace up to three hand-held transmitters with a single built-in device. This feature will learn the radio frequency codes of most transmitters to operate garage doors, entry gate operators, security systems, entry door locks, and home or office lighting.

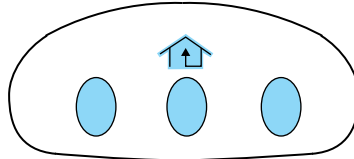

WARNING: When programming your HomeLink® Wireless Control System to a garage door or gate, be sure that people and objects are out of the way to prevent potential injury or damage.

Do not use the HomeLink® Wireless Control System with any garage door opener that lacks safety stop and reverse features as required by U.S. federal safety standards (this includes any garage door opener model manufactured before April 1, 1982). A garage door which cannot detect an object, signaling the door to stop and reverse, does not meet current U.S. federal safety standards. For more information, contact HomeLink® at: **www.homelink.com** or **1-800-355-3515**.

Retain the original transmitter for use in other vehicles as well as for future programming procedures (i.e. new HomeLink® equipped vehicle purchase). It is also suggested that upon the sale of the vehicle, the programmed HomeLink® buttons be erased for security purposes, refer to *Programming* in this section.

Programming

Do not program HomeLink® with the vehicle parked in the garage.

Note: Your vehicle may require the ignition switch to be turned to the accessory position for programming and/or operation of the HomeLink®. It is also recommended that a new battery be placed in the hand-held transmitter of the device being programmed to HomeLink® for quicker training and accurate transmission of the radio-frequency signal.

Driver Controls

1. Position the end of your hand-held transmitter 1–3 inches (2–8 cm) away from the HomeLink® button you wish to program (located on your visor) while keeping the indicator light in view.

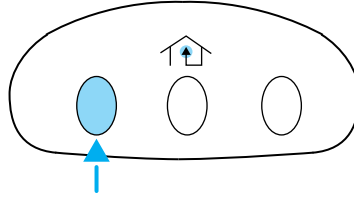

2. Simultaneously press and hold both the chosen HomeLink® and hand-held transmitter buttons until the HomeLink® indicator light changes from a slow to a rapidly blinking light. Now you may release both the HomeLink® and hand-held transmitter buttons.

Note: Some entry gates and garage door openers may require you to replace Step 2 with procedures noted in the *Gate Operator and Canadian Programming* in this section for Canadian residents.

3. Firmly **press and hold for five seconds and release** the programmed HomeLink® button up to two separate times to activate the door. If the door does not activate, press and hold the just-trained HomeLink® button and observe the indicator light.

- If the indicator light **stays on constantly, programming is complete** and your device should activate when the HomeLink® button is pressed and released.
- If the indicator light **blinks rapidly for two seconds and then turns to a constant light continue with “Programming” Steps 4 through 6** to complete programming of a rolling code equipped device (most commonly a garage door opener).

4. At the garage door opener receiver (motor-head unit) in the garage, locate the “learn” or “smart” button (usually near where the hanging antenna wire is attached to the unit).

5. Firmly press and release the “learn” or “smart” button. (The name and color of the button may vary by manufacturer.)

Note: There are 30 seconds in which to initiate Step 6.

6. Return to the vehicle and firmly **press, hold for two seconds and release** the programmed HomeLink® button. Repeat the **press/hold/release** sequence again and, depending on the brand of the garage door opener (or other rolling code equipped device), repeat this sequence a third time to complete the programming.

HomeLink® should now activate your rolling code equipped device. To program additional HomeLink® buttons begin with Step 1 in this section. For questions or comments, please contact HomeLink® at **www.homelink.com** or **1-800-355-3515**.

Driver Controls

Gate Operator & Canadian Programming

During programming, your hand-held transmitter may automatically stop transmitting — not allowing enough time for HomeLink® to accept the signal from the hand-held transmitter.

After completing Step 1 outlined in the *Programming* section, replace Step 2 with the following:

Note: If programming a garage door opener or gate operator, it is advised to unplug the device during the “cycling” process to prevent overheating.

- Continue to press and hold the HomeLink® button (note Step 2 in the *Programming* section) while you press and release — **every two seconds** (“cycle”) your hand-held transmitter until the frequency signal has been accepted by the HomeLink®. The indicator light will flash slowly and then rapidly after HomeLink® accepts the radio frequency signal.
- Proceed with Step 3 in the *Programming* section.

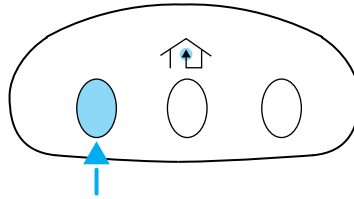

Operating the HomeLink® Wireless Control System

To operate, simply press and release the appropriate HomeLink® button. Activation will now occur for the trained product (garage door, gate operator, security system, entry door lock, or home or office lighting etc.). For convenience, the hand-held transmitter of the device

may also be used at any time. In the event that there are still programming difficulties, contact HomeLink® at www.homelink.com or **1-800-355-3515**.

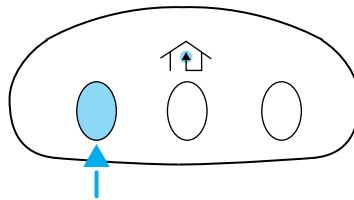

Driver Controls

Erasing HomeLink® buttons

To erase the three programmed buttons (individual buttons cannot be erased):

- Press and hold the two outer HomeLink® buttons until the indicator light begins to flash—after 20 seconds. Release both buttons. Do not hold for longer than 30 seconds.

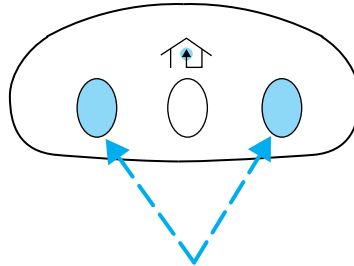

HomeLink® is now in the train (or learning) mode and can be programmed at any time beginning with Step 1 in the *Programming* section.

Reprogramming a single HomeLink® button

To program a device to HomeLink® using a HomeLink® button previously trained, follow these steps:

1. Press and hold the desired HomeLink® button. **Do NOT** release the button.
2. The indicator light will begin to flash after 20 seconds. Without releasing the HomeLink® button, follow Step 1 in the *Programming* section.

For questions or comments, contact HomeLink® at www.homelink.com or **1-800-355-3515**.

STANDARD MESSAGE CENTER (IF EQUIPPED)

With the ignition in the on position, the message center, located on your instrument cluster, displays important vehicle information **through a constant monitor of vehicle systems**. You may select display features on the message center for a display of status preceded by a brief indicator chime. The system will also notify you of potential vehicle problems with a display of system warnings followed by a long indicator chime.

Selectable features

Press and release the SELECT/RESET stem, located in the speedometer, to scroll and reset the following functions. Select or reset the function by pressing and holding the SELECT/RESET stem for more than two seconds.

Driver Controls

Info menu

This menu displays the following:

- Odometer/Trip Odometer (Trip A and Trip B)
- Distance to Empty
- Hold Reset for Setup Menu
- Hold Reset for System check
- Blank

Odometer/Trip odometer

Refer to *Gauges* in the *Instrument Cluster* chapter.

Distance to empty (DTE)

Select this function to estimate approximately how far you can drive with the fuel remaining in your tank under normal driving conditions. Remember to turn the ignition off when refueling to allow this feature to correctly detect the added fuel.



XXX MILES TO E
0.0 mi

The DTE function will display XXX MILES TO E FUEL LEVEL LOW and sound a chime for one second when you have approximately 50 miles (80 km) to empty. If you RESET this warning message, this display and chime will return within 10 minutes.

DTE is calculated using a running average fuel economy, which is based on your recent driving history of 500 miles (800 km). This value is not the same as the average fuel economy display. The running average fuel economy is re-initialized to a factory default value if the battery is disconnected.

Average fuel economy (AFE)

Select this function from the INFO menu to display your average fuel economy in miles/gallon or liters/100 km.



XX.X AVE MPG
0.0 mi

If you calculate your average fuel economy by dividing miles traveled by gallons of fuel used (liters of fuel used by 100 kilometers traveled), your figure may be different than displayed for the following reasons:

- Your vehicle was not perfectly level during fill-up

Driver Controls

- Differences in the automatic shut-off points on the fuel pumps at service stations
 - Variations in top-off procedure from one fill-up to another
 - Rounding of the displayed values to the nearest 0.1 gallon (liter)
1. Drive the vehicle at least 5 miles (8 km) with the speed control system engaged to display a stabilized average.
 2. Record the highway fuel economy for future reference.

It is important to press the SELECT/RESET stem (press and hold for two seconds in order to reset the function) after setting the speed control to get accurate highway fuel economy readings.

Setup Menu

Press and hold the SELECT/RESET stem to get into the SETUP menu sequence from the INFO menu for the following items:

- Oil Life
- Units (English/Metric)
- Rear Park Aid (if equipped)
- Autolamp (if equipped)
- Autolock (if equipped)
- Autounlock (if equipped)
- Easy Entry (if equipped)
- Trailer Sway (if equipped)
- Language
- Reset to English—if in another language (see Note below)

Note: When returning to the SETUP menu and a non-English language has been selected, HOLD RESET FOR ENGLISH will be displayed to change back to English. Press and hold the SELECT/RESET stem to change back to English.

HOLD RESET FOR
ENGLISH

Oil Life XXX% HOLD RESET = NEW

An oil change is required whenever indicated by the message center.
USE ONLY RECOMMENDED ENGINE OILS.

Driver Controls

To reset the oil monitoring system to 100% after each oil change [approximately 7,500 miles (12,000 km) or six months] perform the following:

1. Press and release the SELECT/RESET stem to display OIL LIFE = XXX% HOLD RESET = NEW.



OIL LIFE XXX%
HOLD RESET=NEW

2. Press and hold the SELECT/RESET stem for two seconds and release. Oil life is set to 100% and "OIL LIFE SET TO 100%" is displayed.

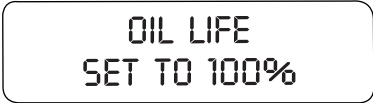

OIL LIFE
SET TO 100%

3. While "OIL LIFE SET TO 100%" is displayed, if a lower oil life start value is desired, press and release the RESET control to reduce the start value. Each press of the SELECT/RESET stem reduces the value by 10 percent.

Note: Oil life start value of 100% equals 7,500 miles (12,000 km) or six months. For example, setting oil life start value to 60% sets the oil life start value to 4,500 miles (7,200 km) and 108 days.

Units (English/Metric)

1. Select this function from the SETUP menu for the current units to be displayed.



UNITS
< ENG > METRIC

2. Press and hold the SELECT/RESET stem to change from English to Metric.

3. Press the SELECT/RESET stem for the next SETUP menu item or wait for more than four seconds to return to the INFO menu.

Rear Park Aid (if equipped)

This feature sounds a warning tone to warn the driver of obstacles near the rear bumper, and functions only when R (Reverse) gear is selected.

Driver Controls

1. To disable/enable the reverse sensing system feature with the vehicle in P (Park), select this function from the SETUP MENU or put the vehicle in R (Reverse).

PARK AID
< ON > OFF

2. Press and hold the SELECT/RESET stem to turn the park aid ON or OFF.

3. Press the SELECT/RESET stem for the next SETUP MENU item or wait for more than four seconds to return to the INFO menu.

Autolamp

This feature keeps your headlights on for up to three minutes after the ignition is switched off.

1. To disable/enable the autolamp delay feature, select this function from the SETUP MENU.

AUTOLAMP DELAY
< 0 > 10 20

2. Press and hold the SELECT/RESET stem to select the new Autolamp delay values of 0, 10, 20, 30, 60, 90, 120 or 180 seconds.

Autolock

This feature automatically locks all vehicle doors when the vehicle is shifted into any gear, putting the vehicle in motion.

1. To disable/enable the autolock feature, select this function from the SETUP MENU.

AUTOLOCK
< ON > OFF

2. Press and hold the SELECT/RESET stem to turn the autolock ON or OFF.

Autounlock

This feature automatically unlocks all vehicle doors when the driver's door is opened within 10 minutes of the ignition being turned off.

1. To disable/enable the autounlock feature, select this function from the SETUP MENU.

AUTOUNLOCK
< ON > OFF

2. Press and hold the SELECT/RESET stem to turn the autounlock ON or OFF.

Driver Controls

Easy Entry (if equipped)

This feature automatically moves the drivers seat backwards for easy exit from the vehicle.

1. To disable/enable the easy entry/exit seat feature, select this function from the SETUP menu.
2. Press and hold the SELECT/RESET stem to turn the easy entry/exit seat on or off.



EASY ENTRY
< ON > OFF

Trailer sway (if equipped)

This feature uses the electronic stability control to mitigate trailer sway.

1. To disable/enable the trailer sway feature, select this function from the SETUP menu.
2. Press the SELECT/RESET stem to turn the trailer sway on or off.



TRAILER SWAY
< ON > OFF

Language

1. Select this function from the SETUP menu.
2. Press and hold the SELECT/RESET stem to select a new language.

Selectable languages are English, Spanish and French

3. Press the SELECT/RESET stem for the next SETUP menu item or wait for more than four seconds to return to the INFO menu.



LANGUAGE =
ENGLISH

Reset to English (if in another language)

When entering the SETUP menu and a non-English language has been selected, HOLD RESET FOR ENGLISH will be displayed.

Press and hold the SELECT/RESET stem to set the language choice.



HOLD RESET FOR
ENGLISH

RESET FOR SYSTEM CHECK

Press and hold the SELECT/RESET stem to get into the system check sequence from the INFO menu for the following items:

The message center will cycle through each of the systems being monitored. For each of the monitored systems, the message center will indicate either an OK message or a warning message for two seconds.

The sequence of the system check report and how it appears in the message center is as follows:

1. XXX% OIL LIFE
2. CHARGING SYSTEM
3. DOOR STATUS
4. BRAKE FLUID LEVEL
5. XX MILES TO E FUEL LEVEL XXX
6. TBC GAIN = XX.X
NO TRAILER (if equipped and no trailer connected)
7. TBC GAIN = XX.X
OUTPUT = // (if equipped and trailer connected)

System warnings

System warnings alert you to possible problems or malfunctions in your vehicle's operating systems.

In the event of a multiple warning situation, the message center will cycle the display to show all warnings by displaying each one for four seconds.

The message center will display the last selected feature if there are no more warning messages. This allows you to use the full functionality of the message center after you acknowledge the warning by pressing the SELECT/RESET stem and clearing the warning message.

Warning messages can be divided into three categories:

- Cannot be cleared until the condition is corrected.
- Reappears 10 minutes after resetting it.
- Reappears if the condition clears, then reoccurs within the same ignition on/off cycle.

Driver Controls

Warning display	Status
Driver door ajar	The warning can return after the ignition key is turned from off to on if the condition still exists.
Passenger door ajar	
Rear left door ajar	
Rear right door ajar	
XXX miles to E fuel level low	The warning can be reset. If the condition/problem occurs again, the message can return after being reset.
Check charging system	
Tire pressure sensor fault	The warning can return after the ignition key is turned from off to on if the condition/problem still exists.
Low tire pressure	
Service RSC now	
Check fuel fill inlet	
Check 4x4 (if equipped)	
Tire pressure monitor fault	
Brake fluid level low	The warning can be reset. The warning can return after the ignition key is turned from off to on if the condition/problem still exists.
Trailer brake module fault (if equipped)	
Oil change required	
XX% Oil life change soon	
Wiring fault on trailer (if equipped)	
Check rear park aid (if equipped)	The warning can be reset. The warning can return immediately after being reset if the condition/problem still exists. The warning will return 10 minutes after being reset if the condition/problem still exists. The warning can return after the ignition key is turned from off to on if the condition/problem still exists.
Trailer disconnected (if equipped)	
Check brake system	

Driver Controls

Warning display	Status
Park brake engaged	The warning can be reset. The warning can return immediately after being reset if the condition still exists. The warning will return 10 minutes after being reset if the condition/problem still exists. The warning can return after the ignition key is turned from off to on if the condition still exists.
Trailer sway reduce speed	The warning can be reset. The warning can return immediately after being reset if the condition still exists.
For 4x4 low stop vehicle (if equipped)	Temporary alert
For 4x4 low shift to N (if equipped)	
To exit 4x4 low stop vehicle (if equipped)	
To exit 4x4 low shift to N (if equipped)	
Trailer connected	
Train left front tire	
Train right front tire	
Train right rear tire	
Train left rear tire	
Tires not trained – repeat	
Training complete	

DRIVER DOOR AJAR — Displayed when the driver door is not completely closed.

PASSENGER DOOR AJAR — Displayed when the passenger door is not completely closed.

REAR LEFT DOOR AJAR — Displayed when the rear left door is not completely closed.

REAR RIGHT DOOR AJAR — Displayed when the rear right door is not completely closed.

Driver Controls

XXX MILES TO E FUEL LEVEL LOW — Displayed as an early reminder of a low fuel condition.

CHECK CHARGING SYSTEM — Displayed when the electrical system is not maintaining proper voltage. If you are operating electrical accessories when the engine is idling at a low speed, turn off as many of the electrical loads as soon as possible. If the warning stays on or comes on when the engine is operating at normal speeds, contact your authorized dealer as soon as possible.

TIRE PRESSURE SENSOR FAULT — Displayed when a tire pressure sensor is malfunctioning, or your spare tire is in use. For more information on how the system operates under these conditions, refer to *Understanding Your Tire Pressure Monitoring System (TPMS)* in the *Tires, Wheels and Loading* chapter. If the warning stays on or continues to come on, contact your authorized dealer as soon as possible.

LOW TIRE PRESSURE — Displayed when one or more tires on your vehicle have low tire pressure. Refer to *Inflating Your Tires* in the *Tires, Wheels and Loading* chapter.

SERVICE RSC NOW — Displayed when the RSC system is not operating properly. If the warning stays on or continues to come on, contact your authorized dealer as soon as possible.

CHECK FUEL FILL INLET — Displayed when the fuel fill inlet may not be properly closed. Refer to *Easy Fuel™ “no cap” fuel system* in the *Maintenance and Specifications* chapter.

CHECK 4X4 (if equipped) — Displayed when a 4X4 system fault is present. For more information, refer to *Four-wheel drive (4WD) operation* in the *Driving* chapter.

TIRE PRESSURE MONITOR FAULT — Displayed when the Tire Pressure Monitoring System is malfunctioning. If the warning stays on or continues to come on, contact your authorized dealer as soon as possible.

BRAKE FLUID LEVEL LOW — Indicates the brake fluid level is low and the brake system should be inspected immediately. Refer to *Brake fluid* in the *Maintenance and Specifications* chapter.

TRAILER BRAKE MODULE FAULT (if equipped) — Displayed and accompanied by a single chime, in response to faults sensed by the TBC. Refer to *Trailer towing* in the *Tires, Wheels and Loading* chapter for more information.

OIL CHANGE REQUIRED — Displayed when an oil change is required.

XX% OIL LIFE CHANGE SOON — Displayed when an oil change will soon be required and shows the percentage of oil life left.

Driver Controls

WIRING FAULT ON TRAILER (if equipped) — Displayed if there are certain faults in the vehicle wiring and trailer wiring/brake system. Refer to *Trailer towing* in the *Tires, Wheels and Loading* chapter for more information.

CHECK REAR PARK AID (if equipped) — Displayed when the transmission is in R (Reverse). Refer to *Reverse sensing system* in the *Driving* chapter.

TRAILER DISCONNECTED (if equipped) — Displayed when a trailer connection becomes disconnected, either intentionally or unintentionally, and has been sensed during a given ignition cycle. Refer to *Trailer towing* in the *Tires, Wheels and Loading* chapter for more information.

CHECK BRAKE SYSTEM — Displayed when a fault has been detected by the ABS module.

PARK BRAKE ENGAGED — Displayed when the parking brake is engaged.

TRAILER SWAY REDUCE SPEED (if equipped) — Displayed when the trailer sway control has detected trailer sway. For more information, refer to the *Driving* chapter for more information.

FOR 4X4 LOW STOP VEHICLE (if equipped) — Displayed when 4X4 LOW is selected while the vehicle is moving. For more information, refer to *Four-wheel drive (4WD) operation* in the *Driving* chapter.

FOR 4X4 LOW SHIFT TO N (if equipped) — Displayed when 4X4 LOW is selected and the vehicle is stopped. For more information, refer to *Four-wheel drive (4WD) operation* in the *Driving* chapter.

TO EXIT 4X4 LOW STOP VEHICLE (if equipped) — Displayed when 2WD is selected while the vehicle is operating in 4X4 LOW. For more information, refer to *Four-wheel drive (4WD) operation* in the *Driving* chapter.

TO EXIT 4X4 LOW SHIFT TO N (if equipped) — Displayed when 2WD is selected while the vehicle has been stopped in 4X4 LOW. For more information, refer to *Four-wheel drive (4WD) operation* in the *Driving* chapter.

TRAILER CONNECTED (if equipped) — Displayed when a correct trailer connection (a trailer with electric trailer brakes) is sensed during a given ignition cycle. Refer to *Trailer towing* in the *Tires, Wheels and Loading* chapter for more information.

TRAIN LEFT FRONT TIRE (if equipped) — Displayed when training the TPMS system. Refer to *TPMS reset procedure* in the *Tires, Wheels and Loading* chapter for more information.

Driver Controls

TRAIN RIGHT FRONT TIRE (if equipped) — Displayed when training the TPMS system. Refer to *TPMS reset procedure* in the *Tires, Wheels and Loading* chapter for more information.

TRAIN RIGHT REAR TIRE (if equipped) — Displayed when training the TPMS system. Refer to *TPMS reset procedure* in the *Tires, Wheels and Loading* chapter for more information.

TRAIN LEFT REAR TIRE (if equipped) — Displayed when training the TPMS system. Refer to *TPMS reset procedure* in the *Tires, Wheels and Loading* chapter for more information.

TIRES NOT TRAINED – REPEAT (if equipped) — Displayed when an error occurs while training the TPMS system. Refer to *TPMS reset procedure* in the *Tires, Wheels and Loading* chapter for more information.

TRAINING COMPLETE (if equipped) — Displayed when training of the TPMS system is complete. Refer to *TPMS reset procedure* in the *Tires, Wheels and Loading* chapter for more information.

OPTIONAL MESSAGE CENTER (IF EQUIPPED)

With the ignition in the on position, the message center, located on your instrument cluster, displays important vehicle information **through a constant monitor of vehicle systems**. You may select display features on the message center for a display of status preceded by a brief indicator chime. The system will also notify you of potential vehicle problems with a display of system warnings followed by a long indicator chime.

Selectable features

Reset

Press this control to select and reset functions shown in the INFO menu and SETUP menu.



Info menu

This control displays the following control displays:

- Trip odometer/Odometer
- Distance to Empty
- Average Fuel Economy



Driver Controls

- Instantaneous Fuel Economy
- Trip Elapsed Drive Time
- Blank

Odometer/Trip odometer

Refer to *Gauges* in the *Instrument Cluster* chapter.

Distance to empty (DTE)

Selecting this function from the INFO menu estimates approximately how far you can drive with the fuel remaining in your tank under normal driving conditions.



XXX MILES TO E
0.0 mi

Remember to turn the ignition off when refueling to allow this feature to correctly detect the added fuel.

The DTE function will display XXX MILES TO E FUEL LEVEL LOW and sound a tone for one second when you have approximately 50 miles (80 km) to empty. If you RESET this warning message, this display and tone will return within 10 minutes.

DTE is calculated using a running average fuel economy, which is based on your recent driving history of 500 miles (800 km). This value is not the same as the average fuel economy display. The running average fuel economy is re-initialized to a factory default value if the battery is disconnected.

Average fuel economy (AFE)

Select this function from the INFO menu to display your average fuel economy in miles/gallon or liters/100 km.



XX.X AVE MPG
0.0 mi

If you calculate your average fuel economy by dividing 100 miles traveled by gallons of fuel used (kilometers traveled by liters used), your figure may be different than displayed for the following reasons:

- Your vehicle was not perfectly level during fill-up
- Differences in the automatic shut-off points on the fuel pumps at service stations
- Variations in top-off procedure from one fill-up to another
- Rounding of the displayed values to the nearest 0.1 gallon (liter)

Driver Controls

1. Drive the vehicle at least 5 miles (8 km) with the speed control system engaged to display a stabilized average.
2. Record the highway fuel economy for future reference.

It is important to press the RESET control after setting the speed control to get accurate highway fuel economy readings.

Instantaneous fuel economy

Select this function from the INFO menu to display your instantaneous fuel economy. This will display your fuel economy as a bar graph ranging from ▼ poor economy to ▲ excellent economy.



Your vehicle must be moving to calculate instantaneous fuel economy. When your vehicle is not moving, this function shows ▼, one or no bars illuminated. Instantaneous fuel economy cannot be reset.

Trip elapsed drive time

Select this function from the INFO menu to display a timer.

To operate the Trip Elapsed Drive Time perform the following:

1. Press and release RESET in order to start the timer.
2. Press and release RESET to pause the timer.
3. Press and hold RESET for two seconds in order to reset the timer.

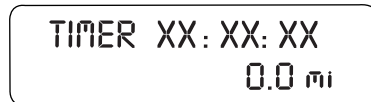

Blank screen

Press the RESET once to turn the message center display off.

Setup menu

Press this control for the following displays:

- Reset For System Check
- Oil Life
- Rear Park Aid (if equipped)
- Running Boards (if equipped)
- Autolamp



Driver Controls

- Autolock
- Autounlock
- Easy Entry (if equipped)
- Trailer Sway (if equipped)
- Units (English/Metric)
- Language
- Reset to English (if in another language)

Reset For System check

Selecting this function from the SETUP menu causes the message center to cycle through each of the systems being monitored. For each of the monitored systems, the message center will indicate either an OK message or a warning message for three seconds.

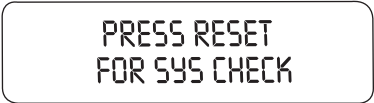

PRESS RESET
FOR SYS CHECK

Pressing the RESET control cycles the message center through each of the systems being monitored.

The sequence of the system check report and how it appears in the message center is as follows:

1. XXX% OIL LIFE
2. CHARGING SYSTEM
3. DOOR STATUS
4. BRAKE FLUID LEVEL
5. XX MILES TO E FUEL LEVEL XXX
6. TBC GAIN = XX.X
NO TRAILER (if equipped and no trailer connected)
7. TBC GAIN = XX.X
OUTPUT = /////
(if equipped and trailer connected)

Oil Life XXX% HOLD RESET = NEW

An oil change is required whenever indicated by the message center and according to the recommended maintenance schedule. USE ONLY RECOMMENDED ENGINE OILS.

Driver Controls

To reset the oil monitoring system to 100% after each oil change (approximately 7,500 miles [12,000 km] or six months) perform the following:

1. Press and release the SETUP control to display “OIL LIFE XXX% HOLD RESET = NEW”.



OIL LIFE XXX%
HOLD RESET = NEW

2. Press and hold the RESET control for two seconds and release. Oil life is set to 100% and “OIL LIFE SET TO 100%” is displayed.



OIL LIFE SET
TO 100%

Note: To change oil life 100% miles value from 7,500 miles (12,000 km) or six months to another value, proceed to Step 3.

3. Once “OIL LIFE SET TO XXX%” is displayed, release and press the RESET control switch to change the Oil Life Start Value. Each release and press will reduce the value by 10%.

Rear Park Aid (if equipped)

This feature sounds a warning tone to warn the driver of obstacles near the rear bumper, and functions only when R (Reverse) gear is selected.

1. To disable/enable the reverse sensing system feature with the vehicle in P (Park), select this function from the SETUP MENU or put the vehicle in R (Reverse).



REAR PARK AID
< ON > OFF

2. Press and hold the RESET control to turn the park aid ON or OFF.
3. Press the RESET control for the next SETUP MENU item or wait for more than four seconds to return to the INFO MENU.

Running Boards (if equipped)

This feature automatically deploys the side running boards for easy entry/exit from the vehicle or for cleaning.

Driver Controls

1. To disable/enable the power running board feature with the vehicle in P (Park), select this function from the SETUP control for the current display mode.

RUNNING BOARD
<AUTO> OFF OUT

2. Press the RESET control to select the running boards setting as follows:

- AUTO: the running boards will automatically deploy when a door is opened and automatically retract when the door is closed,
- OUT: the running boards will remain deployed regardless of the doors being open/closed. This setting can be used when washing the vehicle, or accessing the roof rack. The running boards will stow and enter AUTO mode when the vehicle speed exceeds 5 mph (8 km/h),
- OFF: the running boards will remain IN regardless of the doors being open/closed.

Autolamp delay

This feature keeps your headlights on for up to three minutes after the ignition is switched off.

1. To disable/enable the autolamp delay feature, select this function from the SETUP control for the current display mode.

AUTOLAMP (SEC)
<0> 10 20

2. Press the RESET control to select the new Autolamp delay values of >0, >10, >20, >30, >60, >90, >120 or >180.

Autolock

This feature automatically locks all vehicle doors when the vehicle is shifted into any gear, putting the vehicle in motion.

1. To disable/enable the autolock feature, select this function from the SETUP control for the current display mode.

AUTOLOCK
<ON> OFF

2. Press the RESET control to turn the autolocks ON or OFF.

Autounlock

This feature automatically unlocks all vehicle doors when the driver's door is opened within 10 minutes of the ignition being turned off.

Driver Controls

1. To disable/enable the autounlock feature, select this function from the SETUP MENU.

AUTOUNLOCK
< ON > OFF

2. Press and hold the RESET control switch to turn the autounlock ON or OFF.

3. Press the RESET control switch for the next SETUP MENU item.

Easy Entry (if equipped)

This feature automatically moves the drivers seat backwards for easy exit from the vehicle.

1. To disable/enable the easy entry/exit seat feature, select this function from the SETUP menu.

EASY ENTRY
< ON > OFF

2. Press the RESET control to turn the easy entry/exit seat on or off.

Trailer sway (if equipped)

This feature uses the electronic stability control to mitigate trailer sway.

1. To disable/enable the trailer sway feature, select this function from the SETUP menu for the current display mode.

TRAILER SWAY
< ON > OFF

2. Press the RESET control to turn the trailer sway on or off.

Units (English/Metric)

1. Select this function from the SETUP menu for the current units to be displayed.

UNITS
< ENG > METRIC

2. Press the RESET control to change from English to Metric.

Language

1. Select this function from the SETUP menu for the current language to be displayed.

LANGUAGE =
ENGLISH

2. Waiting four seconds or pressing the RESET control cycles the message center through each of the language choices.

Driver Controls

Selectable languages are English, Spanish, or French.

3. Press and hold the RESET control for two seconds to set the language choice.

Reset to English (if in another language)

When entering the SETUP MENU and a non-English language has been selected, "HOLD RESET FOR ENGLISH" will be displayed.



HOLD RESET FOR
ENGLISH

Press and hold the RESET control to set the language choice.

System warnings

System warnings alert you to possible problems or malfunctions in your vehicle's operating systems.

In the event of a multiple warning situation, the message center will cycle the display to show all warnings by displaying each one for four seconds.

The message center will display the last selected feature if there are no more warning messages. This allows you to use the full functionality of the message center after you acknowledge the warning by pressing the RESET control and clearing the warning message.

Warning messages can be divided into three categories:

- Cannot be cleared until the condition is corrected.
- Reappears 10 minutes after resetting it.
- Reappears if the condition clears, then reoccurs within the same ignition on/off cycle.

Driver Controls

Warning display	Status
Driver door ajar	The warning can return after the ignition key is turned from off to on if the condition still exists.
Passenger door ajar	
Rear left door ajar	
Rear right door ajar	
XXX miles to E fuel level low	The warning can be reset. If the condition/problem occurs again, the message can return after being reset.
Check charging system	
Tire pressure sensor fault	The warning can return after the ignition key is turned from off to on if the condition/problem still exists.
Low tire pressure	
Service RSC now	
Check fuel fill inlet	
Check 4x4 (if equipped)	
Tire pressure monitor fault	
Brake fluid level low	The warning can be reset. The warning can return after the ignition key is turned from off to on if the condition/problem still exists.
Trailer brake module fault (if equipped)	
Oil change required	
XX% Oil life change soon	
Wiring fault on trailer (if equipped)	
Check rear park aid (if equipped)	The warning can be reset. The warning can return immediately after being reset if the condition/problem still exists. The warning will return 10 minutes after being reset if the condition/problem still exists. The warning can return after the ignition key is turned from off to on if the condition/problem still exists.
Trailer disconnected (if equipped)	
Check brake system	

Driver Controls

Warning display	Status
Park brake engaged	The warning can be reset. The warning can return immediately after being reset if the condition still exists. The warning will return 10 minutes after being reset if the condition/problem still exists. The warning can return after the ignition key is turned from off to on if the condition still exists.
Trailer sway reduce speed	The warning can be reset. The warning can return immediately after being reset if the condition still exists.
For 4x4 low stop vehicle (if equipped)	Temporary alert
For 4x4 low shift to N (if equipped)	
To exit 4x4 low stop vehicle (if equipped)	
To exit 4x4 low shift to N (if equipped)	
Trailer connected	
Train left front tire	
Train right front tire	
Train right rear tire	
Train left rear tire	
Tires not trained – repeat	
Training complete	

DRIVER DOOR AJAR — Displayed when the driver door is not completely closed.

PASSENGER DOOR AJAR — Displayed when the passenger door is not completely closed.

REAR LEFT DOOR AJAR — Displayed when the rear left door is not completely closed.

REAR RIGHT DOOR AJAR — Displayed when the rear right door is not completely closed.

Driver Controls

XXX MILES TO E FUEL LEVEL LOW — Displayed as an early reminder of a low fuel condition.

CHECK CHARGING SYSTEM — Displayed when the electrical system is not maintaining proper voltage. If you are operating electrical accessories when the engine is idling at a low speed, turn off as many of the electrical loads as soon as possible. If the warning stays on or comes on when the engine is operating at normal speeds, contact your authorized dealer as soon as possible.

TIRE PRESSURE SENSOR FAULT — Displayed when a tire pressure sensor is malfunctioning, or your spare tire is in use. For more information on how the system operates under these conditions, refer to *Understanding Your Tire Pressure Monitoring System (TPMS)* in the *Tires, Wheels and Loading* chapter. If the warning stays on or continues to come on, contact your authorized dealer as soon as possible.

LOW TIRE PRESSURE — Displayed when one or more tires on your vehicle have low tire pressure. Refer to *Inflating Your Tires* in the *Tires, Wheels and Loading* chapter.

SERVICE RSC NOW — Displayed when the RSC system is not operating properly. If the warning stays on or continues to come on, contact your authorized dealer as soon as possible.

CHECK FUEL FILL INLET — Displayed when the fuel fill inlet may not be properly closed. Refer to *Easy Fuel™ “no cap” fuel system* in the *Maintenance and Specifications* chapter.

CHECK 4X4 (if equipped) — Displayed when a 4X4 system fault is present. For more information, refer to *Four-wheel drive (4WD) operation* in the *Driving* chapter.

TIRE PRESSURE MONITOR FAULT — Displayed when the Tire Pressure Monitoring System is malfunctioning. If the warning stays on or continues to come on, contact your authorized dealer as soon as possible.

BRAKE FLUID LEVEL LOW — Indicates the brake fluid level is low and the brake system should be inspected immediately. Refer to *Brake fluid* in the *Maintenance and Specifications* chapter.

TRAILER BRAKE MODULE FAULT (if equipped) — Displayed and accompanied by a single chime, in response to faults sensed by the TBC. Refer to *Trailer towing* in the *Tires, Wheels and Loading* chapter for more information.

OIL CHANGE REQUIRED — Displayed when an oil change is required.

Driver Controls

XX% OIL LIFE CHANGE SOON — Displayed when an oil change will soon be required and shows the percentage of oil life left.

WIRING FAULT ON TRAILER (if equipped) — Displayed if there are certain faults in the vehicle wiring and trailer wiring/brake system. Refer to *Trailer towing* in the *Tires, Wheels and Loading* chapter for more information.

CHECK REAR PARK AID (if equipped) — Displayed when the transmission is in R (Reverse). Refer to *Reverse sensing system* in the *Driving* chapter.

TRAILER DISCONNECTED (if equipped) — Displayed when a trailer connection becomes disconnected, either intentionally or unintentionally, and has been sensed during a given ignition cycle. Refer to *Trailer towing* in the *Tires, Wheels and Loading* chapter for more information.

CHECK BRAKE SYSTEM — Displayed when a fault has been detected by the ABS module.

PARK BRAKE ENGAGED — Displayed when the parking brake is engaged.

TRAILER SWAY REDUCE SPEED (if equipped) — Displayed when the trailer sway control has detected trailer sway. For more information, refer to the *Driving* chapter for more information.

FOR 4X4 LOW STOP VEHICLE (if equipped) — Displayed when 4X4 LOW is selected while the vehicle is moving. For more information, refer to *Four-wheel drive (4WD) operation* in the *Driving* chapter.

FOR 4X4 LOW SHIFT TO N (if equipped) — Displayed when 4X4 LOW is selected and the vehicle is stopped. For more information, refer to *Four-wheel drive (4WD) operation* in the *Driving* chapter.

TO EXIT 4X4 LOW STOP VEHICLE (if equipped) — Displayed when 2WD is selected while the vehicle is operating in 4X4 LOW. For more information, refer to *Four-wheel drive (4WD) operation* in the *Driving* chapter.

TO EXIT 4X4 LOW SHIFT TO N (if equipped) — Displayed when 2WD is selected while the vehicle has been stopped in 4X4 LOW. For more information, refer to *Four-wheel drive (4WD) operation* in the *Driving* chapter.

TRAILER CONNECTED (if equipped) — Displayed when a correct trailer connection (a trailer with electric trailer brakes) is sensed during a given ignition cycle. Refer to *Trailer towing* in the *Tires, Wheels and Loading* chapter for more information.

Driver Controls

TRAIN LEFT FRONT TIRE (if equipped) — Displayed when training the TPMS system. Refer to *TPMS reset procedure* in the *Tires, Wheels and Loading* chapter for more information.

TRAIN RIGHT FRONT TIRE (if equipped) — Displayed when training the TPMS system. Refer to *TPMS reset procedure* in the *Tires, Wheels and Loading* chapter for more information.

TRAIN RIGHT REAR TIRE (if equipped) — Displayed when training the TPMS system. Refer to *TPMS reset procedure* in the *Tires, Wheels and Loading* chapter for more information.

TRAIN LEFT REAR TIRE (if equipped) — Displayed when training the TPMS system. Refer to *TPMS reset procedure* in the *Tires, Wheels and Loading* chapter for more information.

TIRES NOT TRAINED – REPEAT (if equipped) — Displayed when an error occurs while training the TPMS system. Refer to *TPMS reset procedure* in the *Tires, Wheels and Loading* chapter for more information.

TRAINING COMPLETE (if equipped) — Displayed when training of the TPMS system is complete. Refer to *TPMS reset procedure* in the *Tires, Wheels and Loading* chapter for more information.

POSITIVE RETENTION FLOOR MAT

WARNING: Do not install additional floor mats on top of the factory installed floor mats as they may interfere with the accelerator or the brake pedals.

Position the floor mat so that the eyelet is over the pointed end of the retention post. Make sure that the mat does not interfere with the operation of the accelerator or the brake pedal. To remove the floor mat, reverse the installation procedure.

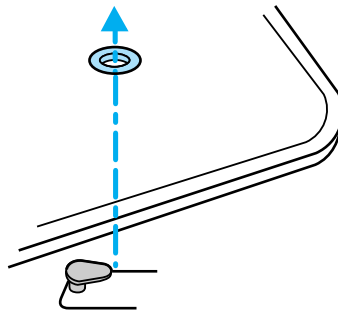

Driver Controls

TAILGATE LOCK (IF EQUIPPED)

Your vehicle may be equipped with a tailgate lock designed to help prevent theft of the tailgate.

- Insert ignition key and turn to the right to engage lock.
- Turn ignition key to the left to unlock.

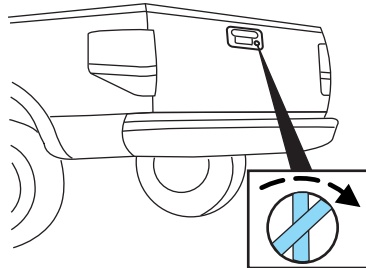

Tailgate removal

Your tailgate is removable to allow more room for loading.

Note: If equipped with a Reverse Camera System (RCS), do steps 1 through 3 before removing the tailgate.

1. Before removal of the tailgate, locate and disconnect the tailgate in-line connector under the pickup box on the passenger side of the vehicle near the spare tire.

2. Install a protective cap (located in the glove box) onto the in-line RCS connector that remains under the pickup box.

3. Partially lower tailgate and carefully feed tailgate harness up through the gap between the pickup box and the bumper. Place the tailgate harness out of the way under the pickup box.

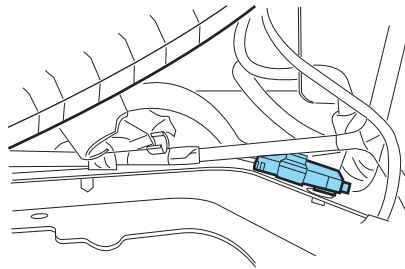

Driver Controls

4. Lower the tailgate.
 5. Using a screwdriver, gently pry the spring clip (on each connector) past the head of the support screw. Disconnect cable.
 6. Disconnect the other cable.
 7. Lift tailgate to a 45-degree angle from horizontal.
 8. Lift right side off of its hinge.
 9. Lift tailgate to a 80-degree angle from horizontal.
 10. Remove tailgate from left side hinge by sliding tailgate to the right.
- To install, follow the removal procedures in reverse order.

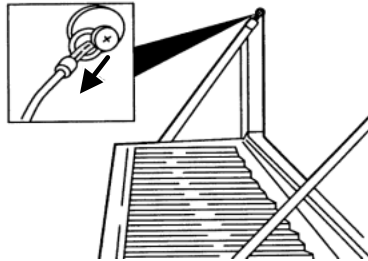

Tailgate step (if equipped)

Your vehicle may be equipped with a feature that allows easier entry into the truck bed. To open the tailgate step:

1. Flip down the tailgate.
2. Pull the yellow latch lever to the unlock position (🔓) to release the grab handle from its stowed position and raise the handle upright until you feel it latch and see the latch lever in the lock position (🔒). The yellow lever only needs to be used when releasing the grab handle.

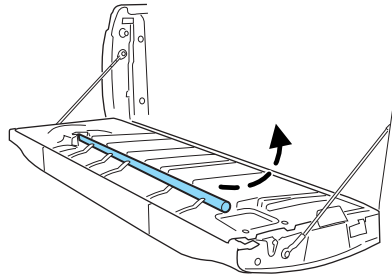

3. Rotate the center molding to unlatch the tailgate step and pull it towards you to extend it.
4. Flip open the step panel to widen the step.

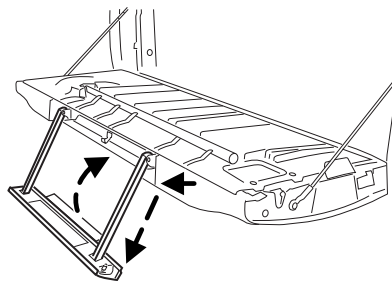

Note: To reduce risk of falling:

- Operate step only when the vehicle is on level surface.
- Operate step only in areas with sufficient lighting
- Always open flip panel to widen step.

Driver Controls

- Always use grab handle when stepping up and down.
- Step not intended for bare-footed use.
- Keep step clean from contamination before use (e.g. snow, mud)
- Keep the step load (you + load) below 350 lb. (159 kg).
- Never drive with step deployed.

To close the tailgate step:

1. Close the step panel, then lift and fully close the tailgate step into the tailgate.
2. Slide the latch at the bottom of the handle, then lower the handle.

Note:

- Fully close and latch the tailgate step before moving the vehicle.
- Never drive with the step or grab handle deployed.
- Replace slip resistance tape (serviceable item) if worn out.
- Replace handle molding (serviceable item) if damaged.
- Do not tow with grab handle or step frame.

Box side step (if equipped)

Your vehicle may be equipped with a box side step that allows easier access to the truck bed.

Note: Do not drive vehicle with box side step(s) in the deployed position.

Note: The Box Side Step load carrying capability (1 person + cargo) is 500 lbs (227 kg). Do not exceed 500 lbs (227 kg).

Driver Controls

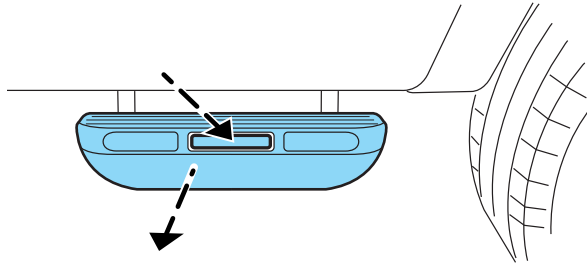

To deploy the box side step, with your foot, push down on the button. The step will automatically extend out from the stowed position.

Note: The box side steps may operate slower in cooler temperatures. In adverse conditions, debris such as mud, dirt, snow, ice, and salt may become trapped in the box side step mechanism, possibly causing the box side step to not deploy automatically after pressing the button. If this occurs, ensure that the button is pressed down, carefully manually pull out the box side step, wash off the debris with a high-pressure car wash wand, and re-stow the step.

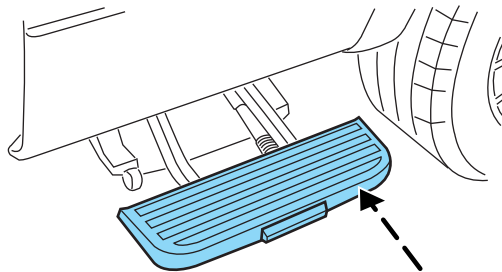

To stow the box side step, with your foot, push the box side step under the truck until fully latched. Do not push on the button while stowing the box side step.

Note: Do not use the box side steps to lift the vehicle when jacking. Utilize proper jacking points. Refer to *Changing the tires* in the *Roadside Emergencies* chapter.

BED EXTENDER (IF EQUIPPED)

Your vehicle may be equipped with a cargo management feature in the truck bed.

Note: This feature is not intended for off-road usage.

Driver Controls

To open the bed extender into tailgate mode:

1. Pull the locking pin toward the center of the vehicle.

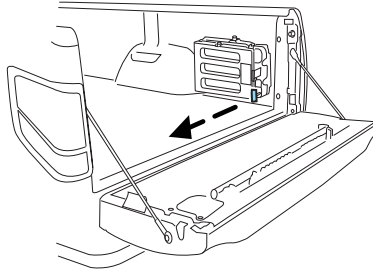

2. Open the latches to release the panels.

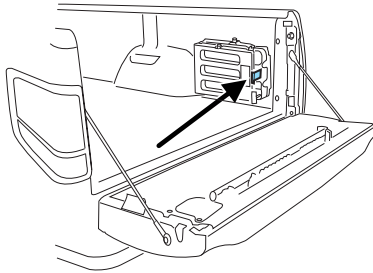

3. Rotate the panels toward the tailgate.

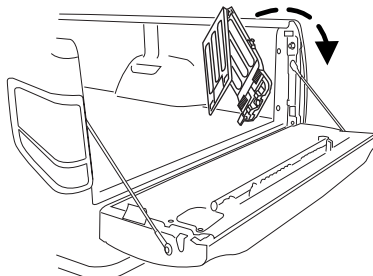

Repeat Steps 1–3 for the other side of the bed extender.

Driver Controls

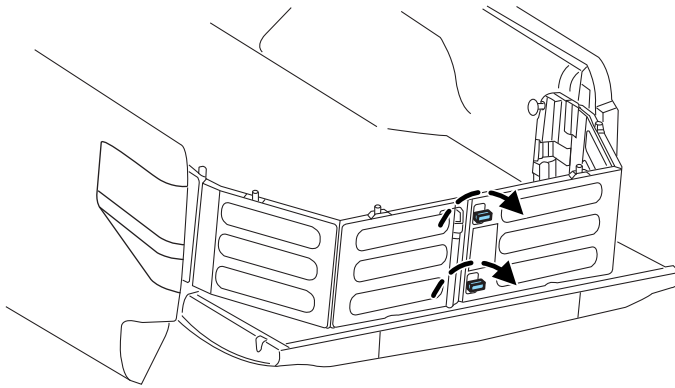

4. Connect the two panels, then rotate both knobs a quarter-turn clockwise to secure the panels.
5. Ensure the latch rod is inserted into the tailgate hole and the locking pins on both sides are engaged into their holes in the pick-up box.
6. Reverse steps for storage of the bed extender.

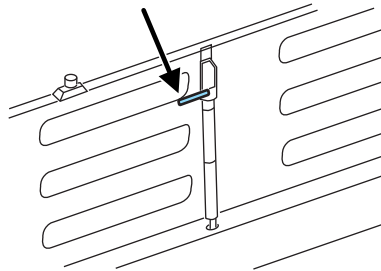

Note: When the vehicle is in motion, ensure the locking pins and knobs are fully engaged.

Note: Ensure all cargo is secured.

Note: When the vehicle is in motion, the tailgate load must not exceed 150 lbs. (68 kg).

Note: The bed extender should always be kept in the grocery mode or stowed position with the tailgate closed when not being used for the purpose of restraining cargo in the tailgate mode.

Driver Controls

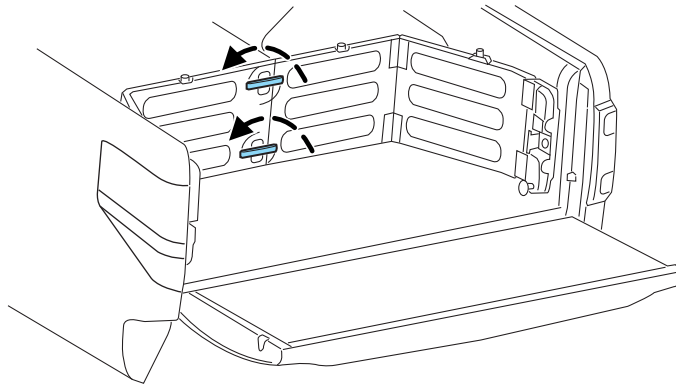

To open the bed extender into grocery mode, follow Steps 1–4 by rotating the panels away from the tailgate. Close the tailgate.

CARGO AREA FEATURES (IF EQUIPPED)

Cargo management system (if equipped)

The cargo management system consists of the Cargo rail package with the following as optional accessories:

- Front header bar (if equipped)
- Cross bars (if equipped)
- Bed divider (if equipped)
- Side mounted tool bins (if equipped)

Driver Controls

Cargo rail package: The strong extruded aluminum double channel rails and four adjustable cleats are designed to hold loads up to 600 lb (272 kg) per cleat (maximum of two cleats per rail).

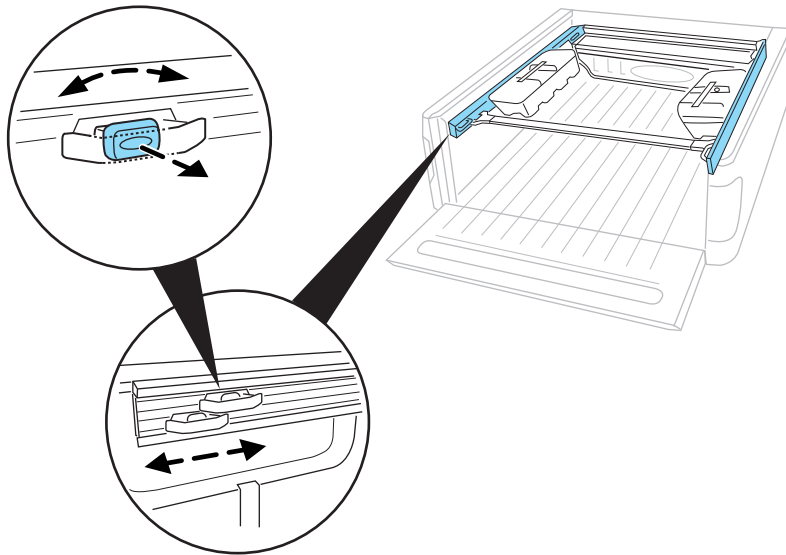

- Cleat positions are adjusted by pulling the knob and turning slightly to lock open. The cleat can then be moved along the rail. Once the desired position is reached, return the knob to the horizontal position. Pull the cleat side-to-side to ensure it has locked into the next available hole location.
- To remove cleat from rail, pull the knob and turn slightly to lock open and slide it off the end of the rail.

When installing cleat, reverse instructions above.

Note: When replacing a cleat into the rail, make sure the oval embossed on the knob is not upside down. This will ensure that the cleat is properly oriented to accept accessory attachments.

Driver Controls

Front header bar: Spans the header area of the pickup box, providing the function of a header rail.

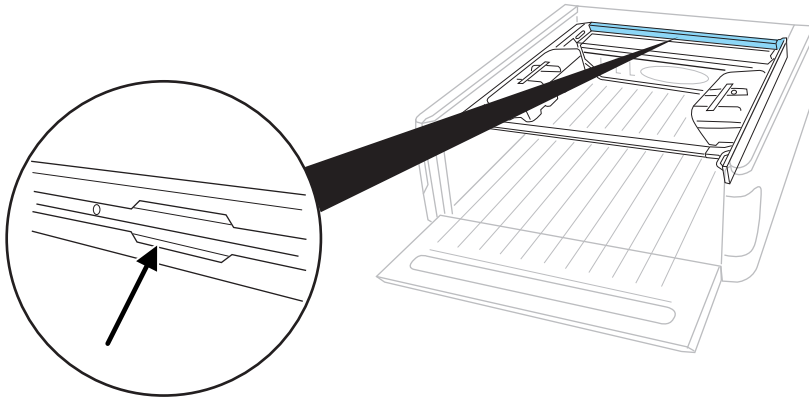

- Attachment cleats from side rails or other attachments may be positioned in the front header bar to secure loads up to 600 lb (272 kg) per cleat (maximum of two cleats).
- Cleats and other attachments may be inserted through the access window located in the center of the header bar. These items can then be slid to either side, and secured the same way as the side rails.

Driver Controls

Cross bars: Aluminum cross bars with T-slot channels in all four sides, and a latch mechanism that allows the end supports to snap over the existing cleats. Cross bars are rated to hold loads up to 100 lb (45 kg) load evenly distributed between the two crossbars, and the T-slots are sized to accept industry-standard roof rack accessories.

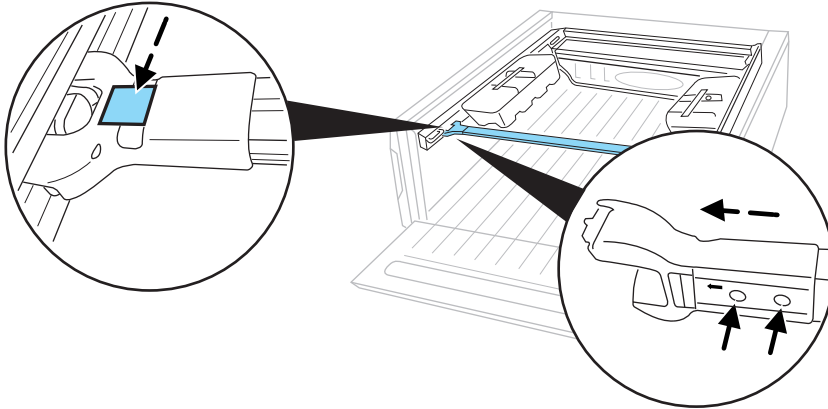

- To remove cross bar, lift handle on each side and lift end support shroud off of the cleat.
- To install cross bar, align cleats directly across from each other on the same rail (upper or lower). Then place crossbar end support onto cleat and press down on each side until the latch handle cycles up and then press the handle down to secure (pull up on the bars to ensure they are securely attached).
- To install accessories into T-slots, remove cross bar and turn upside down, then find the slip joint end, indicated with an arrow embossed on the bottom of the support. Using a T25 Torx driver, remove two Torx head bolts from bottom, and slide end support off of aluminum extrusion. Insert accessory into desired T-slot, and install end support. When tightening Torx head bolts, hand tightening with a Torx driver is sufficient, DO NOT over torque by using a ratchet.

Driver Controls

Bed divider: This panel will keep small items up to 400 lb (180 kg) in position in the pickup box. Also includes T-slots to allow attachment of industry-standard roof rack accessories.

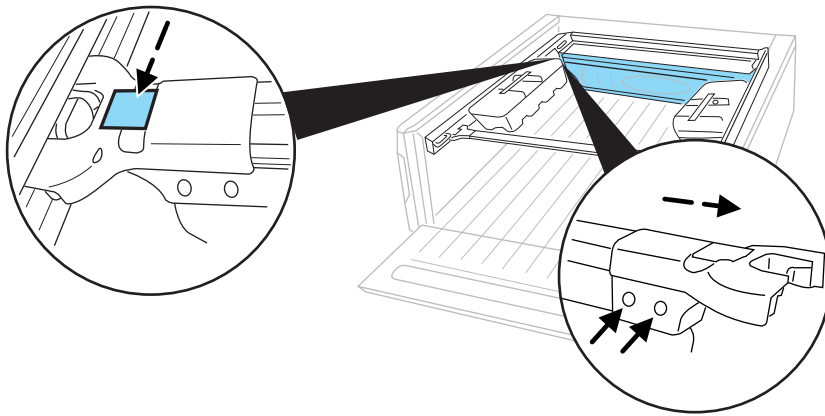

- To remove bed divider, lift handle on each side and lift end support shroud off of the cleat.
- To install bed divider, align cleats directly across from each other on the lower rail. Then place divider end support onto the cleats and press down on each side until the latch handle cycles up then press the handle down to secure (pull up on the divider to ensure they are securely attached).
- To install accessories into T-slots, remove bed divider, then find the slip joint end, indicated with an arrow embossed on the support. Using a T25 Torx driver, remove two Torx head bolts and slide end support off of the aluminum extrusion. Insert accessory into desired T-slot and install end support. When tightening Torx head bolts, hand tightening with a Torx driver is sufficient, DO NOT over torque by using a ratchet.

Driver Controls

Side mounted tool bins: Watertight bins can be positioned at any point along the side rails and can be easily removed (even when full), and carried to wherever the contents are needed. Each bin will hold up to 60 lb (27 kg) of cargo, and has a drain plug for use as a cooler. **Note:** When multiple bins are placed on one side of the pickup box, the total cargo weight in all bins on that side of the pickup box cannot exceed 60 lb (27 kg).

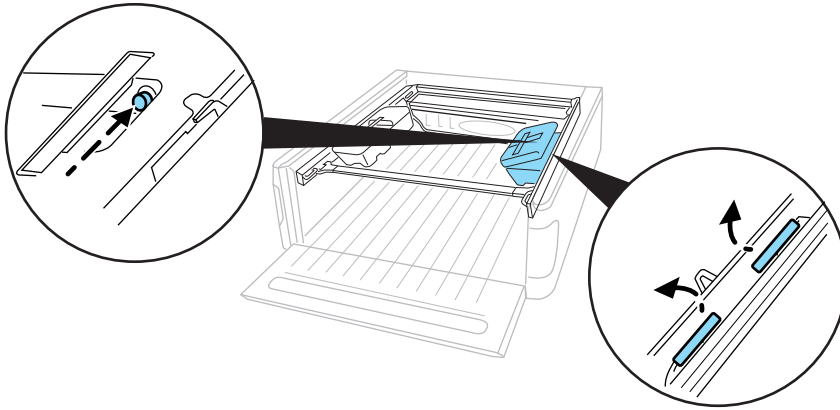

- To access the lock, pull the tab at the base of the rubber cap to uncover the lock. When you are done with the lock always reinstall the rubber cap on the lock to ensure proper sealing. When the bin is unlocked the rubber cap does not need to be removed to open the bin, just press the rubber cap to unlatch the lid.
- The lock cylinder is keyed to the first ignition key to be turned in the lock. This allows one key to work all bins, even if more are ordered through the dealer. The dealer will usually key the locks during pre-delivery, but if necessary, simply remove the sticker covering the keyhole, insert ignition key and turn to the extent of travel in each direction. This key will then be the only key to unlock the bin.
- Once the key has been set, simply turn the key to the right to lock, or to the left to unlock. When locked, the push-button will not depress when pushed.

Driver Controls

- To remove the bin from the rail, open lid and pull up on both levers located on the outboard edge (next to the pickup box top rail) until the handles are all the way up (approximately 90 degrees). Once both handles are raised, the lid may be closed. **Note:** Windows in the lid will allow the handles to stick up above the lid (with the lid closed). After closing the lid, simply lift up and inboard away from the pickup box side to release bin from rail.
- To install, reverse the above instructions.

Note: Remove the bins during severe off road driving to avoid damage to the cargo bins and pickup box.



WARNING: If any levers are visible above the lid of the bin, the bin is not securely attached to the rail, and may become detached from the vehicle if driven in that configuration.

Locks and Security

KEYS

The key operates all locks on your vehicle. In case of loss, replacement keys are available from your dealer.

You should always carry a second key with you in a safe place in case you require it in an emergency.

Refer to the *SecuriLock™ passive anti-theft system* section in this chapter for more information.

POWER DOOR LOCKS (IF EQUIPPED)

Press control to unlock all doors.

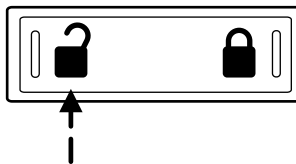

Press control to lock all doors.



Smart unlocking feature

The smart unlocking feature helps prevent you from locking yourself out of your vehicle.

With the key in any ignition position:

- The driver's door will automatically unlock if it is locked by the driver's power lock control while the driver's door is open.

The vehicle may still be locked with the key in the ignition, and performing one of the following actions:

- Pressing the manual lock button on the door.
- Operating the remote entry transmitter.
- Operating the keyless entry keypad.
- Operating the driver's door with a key will only lock the driver's door.

Locks and Security

Autolock

The autolock feature is available on vehicles with power locking. This feature will lock all the doors when:

- all the doors are closed,
- the ignition is in the on position,
- you shift into any gear putting the vehicle in motion, (for manual transmission the park brake should not be engaged) and
- the vehicle attains a speed greater than 12 mph (20 km/h).

The autolock feature repeats when:

- any door is opened then closed while the ignition is in the on position and the vehicle speed is 9 mph (15 km/h) or lower and
- the vehicle attains a speed greater than 12 mph (20 km/h).

Deactivating/activating autolock

Your vehicle comes with the autolock feature enabled. There are four methods to enable/disable this feature:

- Through your authorized dealer, or
- Performing the power door lock control procedure,
- Performing the keyless entry keypad (if equipped) procedure, or
- Performing the message center (if equipped) procedure.

Power door unlock/lock procedure

Before starting, ensure the ignition is in the off position and all vehicle doors are closed. You must complete Steps 1-5 within 30 seconds or the procedure will have to be repeated. If the procedure needs to be repeated, you must wait 30 seconds. **Note: All** doors must be closed and remain closed throughout the configuration process.

1. Turn the ignition to the on position.
2. Press the power door unlock control three times.
3. Turn the ignition from the on to the off position.
4. Press the power door unlock control three times.
5. Turn the ignition back to the on position. The horn will chirp.

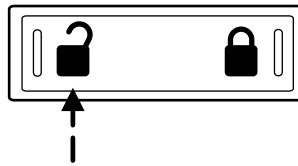

Locks and Security

6. Press the unlock control, then press the lock control. The horn will chirp once if autolock was deactivated or twice (one short and one long chirp) if autolock was activated.

7. Turn the ignition to the off position. The horn will chirp once to confirm the procedure is complete.

Keyless entry keypad procedure

1. Turn the ignition to the off position.
2. Close all doors
3. Enter 5–digit entry code
4. Press and hold the 3 • 4. While holding the 3 • 4 press the 7 • 8.
5. Release the 7 • 8.
6. Release the 3 • 4.

The user should receive a **horn chirp** to indicate the system has been disabled or a chirp followed by a honk to indicate the system has been enabled.

Message center procedure

For information regarding the activation and deactivation of the autolocks feature using the message center, refer to *Message center* in the *Driver Controls* chapter.

Autounlock feature

The autounlock feature will unlock all the doors when:

- the ignition is in the on position, all the doors are closed, and the vehicle has been in motion at a speed greater than 12 mph (20 km/h);
- the vehicle has then come to a stop and the ignition is turned to the off or accessory position; and
- the driver door is opened within 10 minutes of the ignition being transitioned to the off or accessory position.

Note: The doors will not autounlock if the vehicle has been electronically locked before the driver door is opened.

Deactivating/activating autounlock feature

Your vehicle comes with the autounlock features activated; there are four methods to enable/disable this feature:

- Through your authorized dealer,
- by using a power door unlock/lock sequence,

Locks and Security

- using a keypad procedure (if equipped), or
- or by using the instrument cluster message center (if equipped). Refer to *Message center* in the *Driver Controls* chapter.

Note: The autounlock feature can be activated/deactivated independently of the autolock feature.

Power door lock switch autounlock enable/disable procedure

Before starting, ensure the ignition is in the off position and all vehicle doors are closed. You must complete Steps 1–5 within 30 seconds or the procedure will have to be repeated. If the procedure needs to be repeated, wait a minimum of 30 seconds before beginning again.

1. Place the key in the ignition and turn the ignition to the on position.
2. Press the power door unlock control three times.
3. Turn the ignition from the on position to the off position.

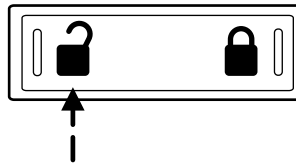

4. Press the power door unlock control three times.
5. Turn the ignition back to the on position. The horn will chirp one time to confirm programming mode has been entered and is active.
6. To enable/disable the autounlock feature, press the lock control, then press the unlock control. The horn will chirp once if autounlock was deactivated or twice (one short and one long chirp) if autounlock was activated.
7. Turn the ignition to the off position. The horn will chirp once to confirm the procedure is complete.

Keyless entry keypad autounlock enable/disable procedure

1. Turn the ignition to the off position.
2. Close all the doors.
3. Enter factory-set 5-digit entry code.
4. Press and hold the 3 • 4. While holding the 3 • 4, press and release the 7 • 8. While still holding the 3 • 4, press and release the 7 • 8 a second time.
5. Release the 3 • 4.

The user should receive a **horn chirp** to indicate the system has been disabled or a chirp followed by a honk to indicate the system has been enabled.

Locks and Security

Message center procedure

For information on activating/deactivating the autounlock feature using the vehicle's message center, refer to *Message center* information in the *Driver Controls* chapter.

CHILDPROOF DOOR LOCKS (ON VEHICLES WITH REAR DOORS)

- When these locks are set, the rear doors cannot be opened from the inside.
- The rear doors can be opened from the outside when the doors are unlocked.

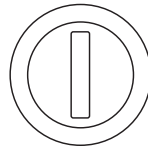

The childproof locks are located on rear edge of each rear door and must be set separately for each door. Setting the lock for one door will not automatically set the lock for both doors.

- Insert the key and turn to the lock position (key horizontal) to engage the childproof locks.
- Insert the key and turn to the unlock position (key vertical) to disengage the childproof locks.

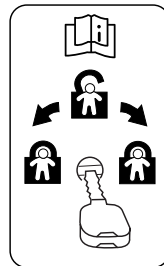

REMOTE ENTRY SYSTEM (IF EQUIPPED)

This device complies with part 15 of the FCC rules and with RS-210 of Industry Canada. Operation is subject to the following two conditions: (1) This device may not cause harmful interference, and (2) This device must accept any interference received, including interference that may cause undesired operation.

Changes or modifications not expressly approved by the party responsible for compliance could void the user's authority to operate the equipment.

The typical operating range for your remote entry transmitter is approximately 33 feet (10 meters). A decrease in operating range could be caused by:

- weather conditions,
- nearby radio towers,

Locks and Security

- structures around the vehicle, or
- other vehicles parked next to your vehicle.

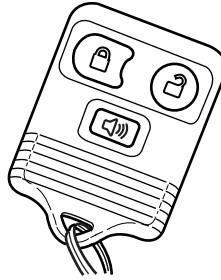

Your vehicle is equipped with a remote entry system which allows you to:

- unlock the vehicle doors without a key.
- lock all the vehicle doors without a key.
- activate the personal alarm.



If there are problems with the remote entry system, make sure to take **ALL remote entry transmitters** with you to your authorized dealer in order to aid in troubleshooting the problem.

Two step door unlocking

1. Press  and release to unlock the driver's door. **Note:** The interior lamps will illuminate if the control on the overhead lamp is **not** set to the **off** position.
2. Press  and release again within three seconds to unlock the passenger doors and the rear doors.



The battery saver feature will turn off the interior lamps 10 minutes after the ignition is turned to the off position.

One step door unlocking

If the one step door unlocking feature is activated, press  and release once to unlock the passenger doors and the rear doors.



Note: The interior lamps will illuminate (refer to the *Illuminated entry* feature later in this section), if the control on the overhead lamp is **not** set to the **off** position.

Switching from two step to one step door unlocking

Your vehicle comes with two step unlocking enabled. Unlocking can be switched between two step and one step door unlocking by pressing and holding both the  and  buttons simultaneously on the remote entry transmitter for approximately four seconds and release. The turn lamps will flash twice to indicate that the vehicle has switched to one step unlocking. Repeat the procedure to switch back to two-step unlocking.

Locks and Security

Locking the doors

1. Press  and release to lock all the doors. The turn signal lamps will flash.
2. Press  and release again within three seconds to confirm that all the doors are closed and locked. **Note:** The doors will lock again, the horn will chirp once, and the turn signal lamps will flash once more.

If any of the doors are not properly closed the horn will make two quick chirps and the turn signal lamps will not flash.

Car finder

Press  twice within three seconds. The horn will chirp and the turn lamps will flash. It is recommended that this method be used to locate your vehicle, rather than using the panic alarm.

Sounding a panic alarm

Press  to activate the alarm. Press again or turn the ignition to accessory or on to deactivate.

Note: The panic alarm will only operate when the ignition is in the off position.

Memory seats/power mirrors/adjustable pedals/steering column (if equipped)

The remote entry transmitter allows you to recall the memory seat/power mirrors/adjustable pedals/steering column (if equipped) feature.



Press  to automatically move the seat, mirrors, adjustable pedals and steering column (if equipped) to the desired memory position.

Note: The seat will not travel to its final position if the key is not in the ignition and the easy entry feature is enabled.

Locks and Security

Activating the three-button memory switch (if equipped)

To activate this feature:

1. Position the seat, power mirrors, adjustable pedals and steering column (if equipped) to the desired positions.
2. Press the SET control on the driver's seat memory switch.
3. Within five seconds, press the 1 or 2 control on the driver's seat memory switch to associate with Driver 1 or Driver 2 positions.
4. Press the SET control again.
5. Within 5 seconds, press the  or  button on the associated remote entry transmitter.
6. Press the 1 or 2 control on the driver's seat memory switch.
7. Repeat this procedure for another remote transmitter if desired.

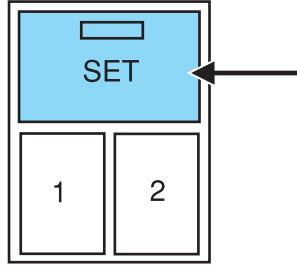

Deactivating the three-button memory switch (if equipped)

To deactivate this feature:

1. Press the SET control on the driver's seat memory switch.
2. Within five seconds, press any control on the remote transmitter which you would like to deactivate and then press the SET control on the driver's seat memory switch.
3. Repeat this procedure for another remote transmitter if desired.

Locks and Security

Activating the two-button memory switch (if equipped)

To activate this feature:

1. Position the seat, power mirrors, adjustable pedals and steering column (if equipped) to the desired positions.

2. Press and hold either the 1 or 2 control on the driver's seat for five seconds. (A tone will be heard after 1½ seconds when the memory store is done) continue to hold until a second tone is heard after five seconds.



3. Within three seconds press the  control on the remote entry transmitter.

4. A tone will be heard when the activation is complete.

5. Repeat this procedure for another remote entry transmitter if desired.

Deactivating the two-button memory switch (if equipped)

1. Press and hold either the 1 or 2 control on the driver's seat memory switch for five seconds. (A tone will be heard after 1½ seconds when the memory store is done) continue to hold until a second tone is heard after five seconds.

2. Within three seconds press the  control on the remote entry transmitter.

3. A tone will be heard when the deactivation is complete.

4. Repeat this procedure for another remote entry transmitter if desired.

Replacing the battery

The remote entry transmitter uses one coin type three-volt lithium battery CR2032 or equivalent.

Locks and Security

To replace the battery:

1. Twist a thin coin between the two halves of the remote entry transmitter near the key ring. **DO NOT TAKE THE RUBBER COVER AND CIRCUIT BOARD OFF THE FRONT HOUSING OF THE REMOTE ENTRY TRANSMITTER.**

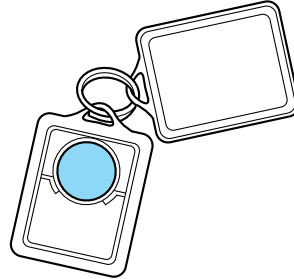

2. Do not wipe off any grease on the battery terminals on the back surface of the circuit board.

3. Remove the old battery.

Note: Please refer to local regulations when disposing of transmitter batteries.

4. Insert the new battery. Refer to the diagram inside the remote entry transmitter for the correct orientation of the battery. Press the battery down to ensure that the battery is fully seated in the battery housing cavity.

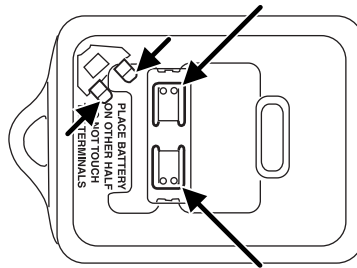

5. Snap the two halves back together.

Note: Replacement of the battery will **not** cause the remote transmitter to become deprogrammed from your vehicle. The remote transmitter should operate normally after battery replacement.

Replacing lost transmitters

If a remote transmitter has been lost and you would like to remove it from the vehicle's memory, or you would like to purchase additional remote transmitters and have them programmed to your vehicle:

- Take **all** your vehicle's transmitters to your authorized dealer for programming, or
- Perform the programming procedure yourself.

Programming remote transmitters

It is necessary to have **all** (maximum of four — original and/or new) of your remote transmitters available prior to beginning this procedure. If all remote entry transmitters are not present during the programming

Locks and Security

procedure, the transmitters that are not present during programming will no longer operate the vehicle.

To program the transmitters yourself:

Note: Ensure the brake pedal is not depressed during this sequence.

- Unlock all doors using the power door lock/unlock control. Insert a key and turn the ignition from the 1 (off) to the 3 (on) position and cycle between 1 (off) and 3 (on) eight times in rapid succession (within 10 seconds) with the eighth turn ending in the 3 (on) position. The locks will cycle to confirm that the programming mode has been entered.
- Within 20 seconds, program a remote transmitter by pressing any button on a transmitter. The locks will cycle once to confirm that the remote transmitter has been programmed. (If more than 20 seconds pass before pressing a remote transmitter button, the programming mode will exit and the procedure will have to be repeated.)
- Repeat the previous step to program additional remote transmitters. The locks will cycle once to confirm that each remote transmitter has been programmed.
- When you have completed programming the remote transmitters, turn the ignition to the 1 (off) position or wait 20 seconds. Again the doors will lock/unlock to confirm programming has been completed.

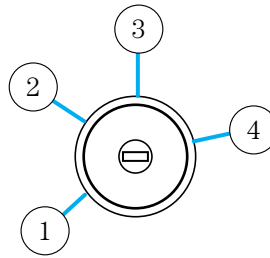

Illuminated entry

The interior lamps illuminate when the remote entry system is used to unlock the door(s) or sound the personal alarm, or when the factory set 5-digit code or your personal code are correctly entered into the keyless keypad.

The illuminated entry system will turn off the interior lights if:

- the ignition switch is turned to the on position, or
- the remote transmitter lock control is pressed, or
- after 25 seconds of illumination.

The dome lamp control (if equipped) must **not** be set to the off position for the illuminated entry system to operate.

Locks and Security

The inside lights will not turn off if:

- they have been turned on with the dimmer control, or
- any door is open.

The battery saver will shut off the interior lamps 10 minutes after the last door is closed, even if the dimmer control is on.

Perimeter lighting feature (if equipped)

The perimeter lighting feature illuminates the exterior of the vehicle in order to provide better visibility to the user while he or she approaches and enters the vehicle.

The perimeter lighting feature activates when:

- the ignition is in the off position,
- the autolamp sensor determines that it is dark, and
- the user activates an unlock feature, using either the remote keyless transmitter or the keypad.

The perimeter lighting feature will illuminate the headlamps and parking lamps for 25 seconds, or until:

- the ignition is turned to any position other than the off position, or
- the user activates a lock feature, using either the remote keyless transmitter or the keypad.

Enabling/disabling the perimeter lighting feature

Your vehicle comes with the perimeter lighting feature enabled. All vehicle doors must be closed before beginning the procedure. You must complete Steps 1–5 within 30 seconds, or the procedure will have to be repeated. If the procedure needs to be repeated, you must wait a minimum of 30 seconds to begin again.

1. Turn the ignition to the on position, then press the power door  control three times.



2. Turn the ignition to the off position, then press the power door  control three times.

3. Turn the ignition to the on position; the horn will chirp to indicate the driver configuration mode has been activated.

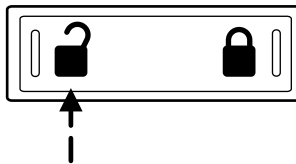
4. Within five seconds, press the power door  control two times. **Note:** One horn chirp should be heard, indicating the system has been disabled.



Locks and Security

Conversely, a horn chirp followed by a honk will indicate the system is enabled. Pressing the power door  control two times again will turn the feature on if it was previously off, or off if it was previously on. Every two consecutive presses of the power door  control after successfully entering the configuration mode will change the enable/disable condition of the feature.

5. Turn the ignition to the off position to exit programming. **Note:** After exiting the driver configuration mode, the horn will chirp once to indicate a feature has been activated/deactivated.

SECURICODE™ KEYLESS ENTRY SYSTEM (IF EQUIPPED)

You can use the keyless entry keypad to:

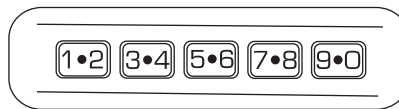

- lock all vehicle doors.
- unlock only the driver's door.
- unlock all vehicle doors.
- program/erase the customer keycode.
- enable/disable the autolocking feature.

The keypad can be operated with the factory set 5-digit entry code; this code is located on the owner's wallet card in the glove box, is marked on the computer module, and is available from your authorized dealer. You can also create your own 5-digit personal entry code.

When pressing the controls on the keypad, press the middle of the controls to ensure a good activation.

Anti-scan feature

The keyless entry keypad is equipped with an anti-theft function called "antiscan." The antiscan feature provides a one-minute lockout feature, where the user is unable to enter the vehicle using the keypad; this lockout occurs when a valid entry code has not been entered by the user within seven attempts (35 consecutive button presses). During the lockout, the keypad will flash and pressing the controls on the keypad will be ignored, except for pressing the 7 • 8 and the 9 • 0 controls simultaneously, which will still lock the vehicle.

The anti-scan feature will be turned off after:

- one minute, when the anti-scan feature times out.
- one minute of keypad inactivity.
- the  control is pressed on the remote entry transmitter.

Locks and Security

- the ignition is turned from the off position to the on position, or from the on position to the off position.

Programming a personal entry code

To create your own personal entry code:

1. Enter the factory set code (keypad will illuminate when pressed).
2. Within five seconds press the 1 • 2 on the keypad.
3. Enter your personal 5-digit code. Each number must be entered within five seconds of each other.
4. After the code is entered, the locks will cycle, confirming that the new code has been set.

Tips:

- Do not set a code that uses five of the same number.
- Do not use five numbers in sequential order.
- The factory set code will work even if you have set your own personal code.
- If you set a second personal code it will erase your first personal code.

Erasing personal code

1. Enter the factory set 5-digit code.
2. Press and release 1 • 2 then,
3. Press and hold the 1 • 2 for two seconds. This must be done within five seconds of completing Step 1.

Your personal code is now erased and only the factory set 5-digit code will work.

Unlocking and locking the doors using keyless entry keypad

To unlock the driver's door, enter the factory set 5-digit code or your personal code. Each number must be pressed within five seconds of each other. **Note:** The driver's door will unlock and the interior lamps will illuminate after the factory set 5-digit code or your personal code are correctly entered.

To unlock all doors, press the 3 • 4 control within five seconds.

To lock all doors, press the 7 • 8 and the 9 • 0 at the same time. You **do not** need to enter the keypad code first. **Note:** The interior lamps will turn off.

SECURILOCK™ PASSIVE ANTI-THEFT SYSTEM

SecuriLock™ passive anti-theft system is an engine immobilization system. This system is designed to help prevent the engine from being

Locks and Security

started unless a **coded key programmed to your vehicle** is used. The use of the wrong type of coded key may lead to a “no-start” condition.

Your vehicle comes with two coded keys; additional coded keys may be purchased from your authorized dealer. The authorized dealer can program your spare keys to your vehicle or you can program the keys yourself. Refer to *Programming spare keys* for instructions on how to program the coded key.

Note: The SecuriLock™ passive anti-theft system is not compatible with non-Ford aftermarket remote start systems. Use of these systems may result in vehicle starting problems and a loss of security protection.

Note: Large metallic objects, electronic devices that are used to purchase gasoline or similar items, or a second coded key on the same key chain may cause vehicle starting issues. You need to prevent these objects from touching the coded key while starting the engine. These objects will not cause damage to the coded key, but may cause a momentary issue if they are too close to the key when starting the engine. If a problem occurs, turn the ignition off, remove all objects on the key chain away from the coded key and restart the engine.

Note: Do not leave a duplicate coded key in the vehicle. Always take your keys and lock all doors when leaving the vehicle.

Anti-theft indicator

The anti-theft indicator is located in the instrument cluster.

- When the ignition is in the off position, the indicator will flash once every two seconds to indicate the SecuriLock™ system is functioning as a theft deterrent.
- When the ignition is in the on position, the indicator will glow for three seconds to indicate normal system functionality.



If a problem occurs with the SecuriLock™ system, the indicator will flash rapidly or glow steadily when the ignition is in the on position. If this occurs, turn the ignition off then back to on to make sure there was no electronic interference with the programmed key. If the vehicle doesn't start, try to start it with the 2nd programmed key and if successful contact your authorized dealership for key replacement. If the indicator still flashes rapidly or glows steadily, the vehicle will not start, contact your authorized dealer as soon as possible for service.

Locks and Security

Automatic arming

The vehicle is armed immediately after switching the ignition to the off position.

Automatic disarming

Switching the ignition to the on position with a **coded key** disarms the vehicle.

Replacement keys

If your keys are lost or stolen and you don't have an extra coded key, you will need to have your vehicle towed to an authorized dealer. The key codes need to be erased from your vehicle and new coded keys will need to be programmed.

Replacing coded keys can be very costly. Store an extra programmed key away from the vehicle in a safe place to help prevent any inconveniences. Please visit an authorized dealer to purchase additional spare or replacement keys.

Programming spare keys

A maximum of eight keys can be coded to your vehicle. Only SecuriLock™ keys can be used. To program a **coded key** yourself, you will need two previously programmed **coded keys** (keys that already operate your vehicle's engine) and the new unprogrammed key(s) readily accessible for timely implementation of each step in the procedure.

If two previously programmed coded keys are not available, you must bring your vehicle to your authorized dealer to have the spare coded key(s) programmed.

Please read and understand the entire procedure before you begin.

1. Insert the first previously programmed **coded key** into the ignition.
2. Turn the ignition from the 1 (off) position to the 3 (on) position. Keep the ignition in the 3 (on) position for at least three seconds, but no more than 10 seconds.
3. Turn the ignition to the 1 (off) position and remove the first **coded key** from the ignition.

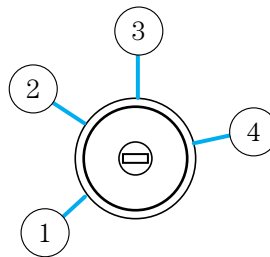

Locks and Security

4. After three seconds but within 10 seconds of turning the ignition to the 1 (off) position, insert the second previously **coded key** into the ignition.
5. Turn the ignition from the 1 (off) position to the 3 (on) position. Keep the ignition in the 3 (on) position for at least three seconds, but no more than 10 seconds.
6. Turn the ignition to the 1 (off) position and remove the second previously programmed **coded key** from the ignition.
7. After three seconds but within 20 seconds of turning the ignition to the 1 (off) position and removing the previously programmed **coded key**, insert the new unprogrammed key (new key/valet key) into the ignition.
8. Turn the ignition from the 1 (off) position to the 3 (on) position. Keep the ignition in the 3 (on) position for at least six seconds.
9. Remove the newly programmed **coded key** from the ignition.

If successful, the new coded key(s) will start the vehicle's engine and the theft indicator will illuminate for three seconds and then go out.

If not successful, the new coded key(s) will not start the vehicle's engine and the theft indicator will flash on and off and you may repeat Steps 1 through 5. If failure repeats, bring your vehicle to your authorized dealer to have the new spare key(s) programmed.

Seating and Safety Restraints

SEATING

! **WARNING:** Reclining the seatback can cause an occupant to slide under the seat's safety belt, resulting in severe personal injuries in the event of a collision.

! **WARNING:** Do not pile cargo higher than the seatbacks to reduce the risk of injury in a collision or sudden stop.

! **WARNING:** Before returning the seatback to its original position, make sure that cargo or any objects are not trapped behind the seatback. After returning the seatback to its original position, pull on the seatback to ensure that it has fully latched. An unlatched seat may become dangerous in the event of a sudden stop or collision.

Adjustable head restraints

Your vehicle is equipped with front row outboard head restraints that are vertically adjustable.

! **WARNING:** To minimize the risk of neck injury in the event of a crash, the driver and passenger occupants should not sit in and/or operate the vehicle, until the head restraint is placed in its proper position. The driver should never adjust the head restraint while the vehicle is in motion.

The adjustable head restraints consist of :

- a trimmed energy absorbing foam and structure (1),
- two steel stems (2),
- a guide sleeve adjust/release button (3),
- and a guide sleeve unlock/remove button (4).

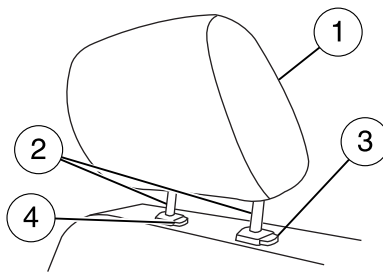

Seating and Safety Restraints

To adjust the head restraint, do the following:

1. Adjust the seatback to an upright driving/riding position.
2. Raise the head restraint by pulling up on the head restraint.

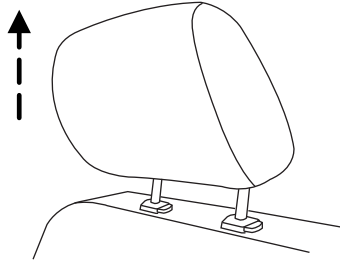

3. Lower the head restraint by pressing and holding the guide sleeve adjust/release button and pushing down on the head restraint.

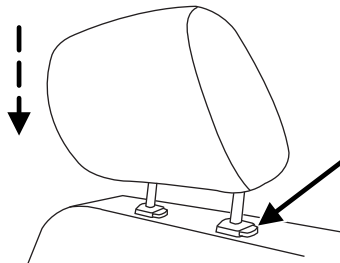

Properly adjust the head restraint so that the top of the head restraint is even with the top of your head and positioned as close as possible to the back of your head. For occupants of extremely tall stature, adjust the head restraint to its full up position.



WARNING: The adjustable head restraint is a safety device. Whenever possible it should be installed and properly adjusted when the seat is occupied.

Seating and Safety Restraints

To remove the adjustable head restraint, do the following:

1. Pull up the head restraint until it reaches the highest adjustment position.

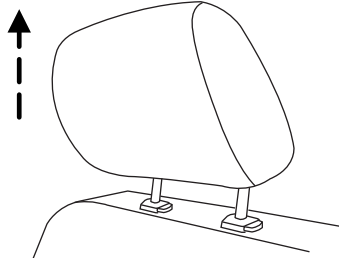

2. Simultaneously press and hold both the adjust/release button and the unlock/remove button, then pull up on the head restraint.

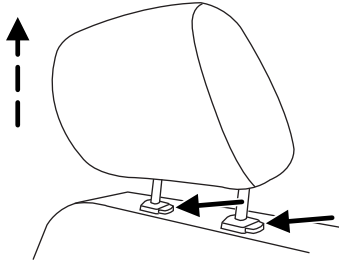

To reinstall the adjustable head restraint, do the following:

1. Insert the two stems into the guide sleeve collars.
2. Push the head restraint down until it locks.

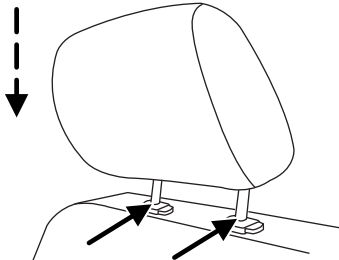

Properly adjust the head restraint so that the top of the head restraint is even with the top of your head and positioned as close as possible to the back of your head. For occupants of extremely tall stature, adjust the head restraint to its full up position.

Seating and Safety Restraints



WARNING: To minimize the risk of neck injury in the event of a crash, head restraints must be installed properly.

Front seat

- Lift the track release bar to move the seat forward or rearward. Make sure that the seat is related into place.

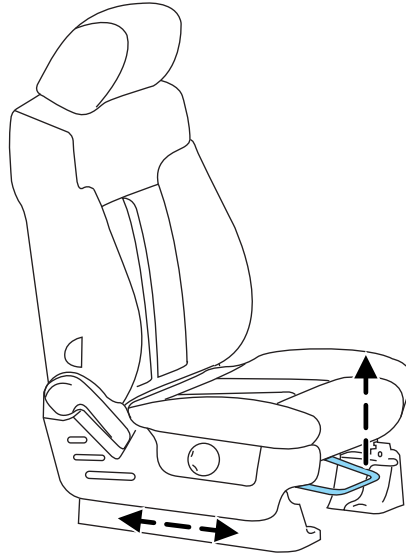

Seating and Safety Restraints

- Pull the release lever handle located on the side of the seat up to move the seatback forward or backward.

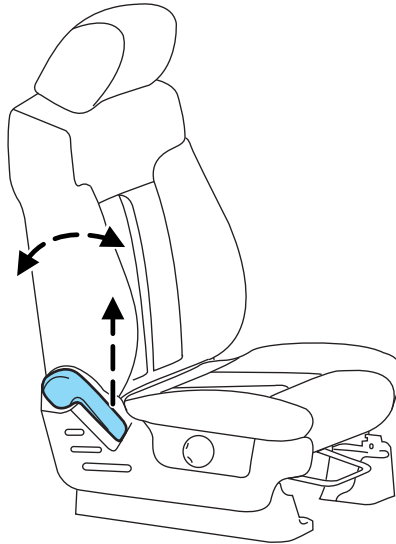

Using the armrest (if equipped)

- Push the release control to move the armrest up or down.
- Pull out the drawer at the bottom of the center seat to access the cup holders (if equipped)

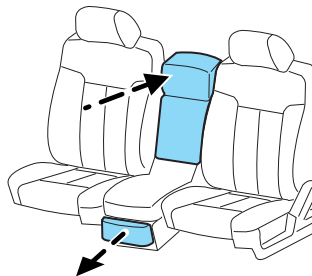

Seating and Safety Restraints

- To gain access to the storage compartment (if equipped) in your armrest, lift the latch to open the lid.

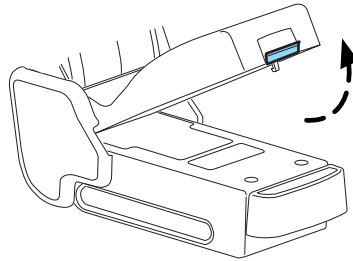

Using the manual lumbar support

For more lumbar support, turn the lumbar support control toward the front of vehicle.

For less lumbar support, turn the lumbar support control toward the rear of vehicle.

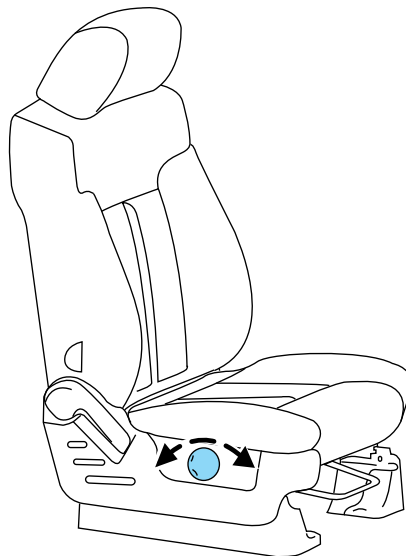

Seating and Safety Restraints

Using the power lumbar support (if equipped)

The power lumbar control is located on the outboard side of the seat.

Press the forward side of the control for additional support.

Press the rear side of the control to reduce support.

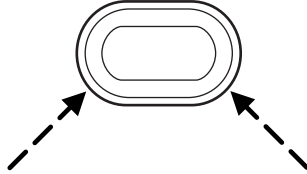

Adjusting the front power seat (if equipped)



WARNING: Never adjust the driver's seat or seatback when the vehicle is moving.



WARNING: Always drive and ride with your seatback upright and the lap belt snug and low across the hips.



WARNING: Reclining the seatback can cause an occupant to slide under the seat's safety belt, resulting in severe personal injuries in the event of a collision.



WARNING: Sitting improperly out of position or with the seat back reclined too far can take off weight from the seat cushion and affect the decision of the passenger sensing system, resulting in serious injury or death in a crash. Always sit upright against your seatback, with your feet on the floor.



WARNING: To reduce the risk of possible serious injury: Do not hang objects off seat back or stow objects in the seatback map pocket (if equipped) when a child is in the front passenger seat. Do not place objects underneath the front passenger seat or between the seat and the center console (if equipped). Check the "passenger airbag off" or "pass airbag off" indicator lamp for proper airbag status. Refer to *Front passenger sensing system* section for additional details. Failure to follow these instructions may interfere with the front passenger seat sensing system.

Seating and Safety Restraints

The control is located on the outboard side of the seat cushion.

Move the switch in the direction of the arrows to raise or lower the front portion of the seat cushion.

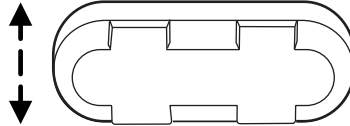

Move the switch in the direction of the arrows to raise or lower the rear portion of the seat cushion.

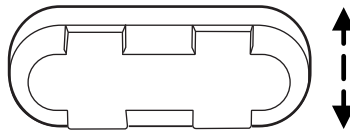

Press the switch in the direction of the arrows to move the seat forward, backward, up or down.

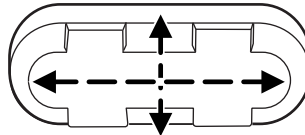

Press the control to recline the seatback forward or rearward.

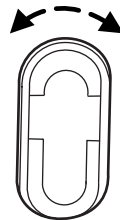

Seating and Safety Restraints

Memory seat/power mirrors/adjustable pedals (Three-button switch) (if equipped)

This system allows automatic positioning of the driver seat and adjustable pedals to two programmable positions.

The memory seat control is located on the driver's seat.

- To program position one, move the driver seat and adjustable pedals to the desired position. Press the SET control. The SET control indicator light will briefly illuminate. While the light is illuminated, press control 1.
- To program position two, repeat the previous procedure using control 2.

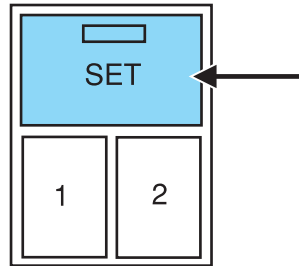

A position can only be recalled when the transmission gearshift is in Park. A memory position may be programmed at any time.

Memory seat/power mirrors/adjustable pedals (Two-button switch) (if equipped)

This system allows automatic positioning of the driver seat, outside rearview mirrors and adjustable pedals to two programmable positions.

The memory seat control is located on the driver's seat.

- To program position one, move the driver seat, exterior mirrors and adjustable pedals to the desired positions using the associated controls. Press and hold control button 1 for at least two seconds.
- To program position two, repeat the previous procedure using control button 2.

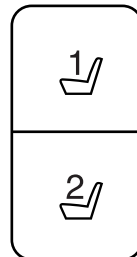

A position can only be recalled when the transmission gearshift is in Park (automatic transmission). A memory seat position may be programmed at any time.

Seating and Safety Restraints

The memory seat positions are also recalled when you press your remote entry transmitter  (unlock) control and the transmitter is programmed to a memory seat position or when you enter a valid customer code 1 or 2 on the keypad.

To program the memory seat to remote entry transmitter, refer to *Remote entry system* in the *Locks and Security* chapter.

Note: The seat will not travel to its final position if the key is not in the ignition and the easy entry feature is enabled.

Easy-access/easy-out feature (if equipped)

The easy entry feature automatically moves the driver's seat 2 inches (5 cm) forward when:

- the transmission is in P (Park)
 - the key is inserted into the ignition cylinder
- (If the seat is located less than 2 inches [5 cm] from the front of the seat track, the seat will travel up to ¼ inch (.64 cm) to the front of the seat track).

The easy out feature automatically moves the driver's seat 2 inches (5 cm) backward when:

- the transmission is in P (Park)
- the key is removed from the ignition cylinder

(If the seat is located less than 2 inches (5 cm) from the rear of the seat track, the seat will travel up to ¼ inch (.64 cm) to the rear of the seat track).

If the memory setting is programmed through the remote transmitter, upon unlocking the door via remote entry system, the seat position will travel to the desired memory setting less 2 inches (5 cm). Once entering the vehicle and inserting the key in the ignition while in P (Park), the easy entry feature will move the seat an additional 2 inches (5 cm) to the desired memory location. See *Locks and Security* for activating the memory seat feature through the remote entry system.

Deactivating/activating the easy access/easy out feature

The easy entry/exit feature can be turned off or on through the vehicle message center (if equipped). If your vehicle does not have a message center, the feature can be turned off or on through the following process:

1. Put the key into the ignition (The driver seat may move forward if the easy entry/exit feature is activated).

Seating and Safety Restraints

2. Place the ignition key into the on position (do not start the vehicle). When the vehicle is in the on position, the interior and exterior lights, the climate controls, and the radio are functional without the engine started. See *Programming remote transmitters* for ignition switch diagram.
3. Turn the ignition key to the off position.
4. Cycle the ignition key between the off position and the on position a total of three times ending with the ignition in the off position.
5. Engage the forward or rearward seat switch.
6. Remove the ignition key from the ignition switch. (The driver seat may move rearward if the easy entry/exit feature is activated).

Steps 2 through 6 must be performed within a 20 second period. The easy entry/exit feature will be deactivated. Repeating the above process will also reactivate the easy entry/exit feature.

Heated seats (if equipped)



WARNING: Persons who are unable to feel pain to the skin because of advanced age, chronic illness, diabetes, spinal cord injury, medication, alcohol use, exhaustion, or other physical conditions, must exercise care when using the seat heater. The seat heater may cause burns even at low temperatures, especially if used for long periods of time. Do not place anything on the seat that insulates against heat, such as a blanket or cushion, because this may cause the seat heater to overheat. Do not puncture the seat with pins, needles, or other pointed objects because this may damage the heating element which may cause the seat heater to overheat. An overheated seat may cause serious personal injury.

Note: Do not do the following:

- Place heavy objects on the seat
- Operate the seat heater if water or any other liquid is spilled on the seat. Allow the seat to dry thoroughly.

To operate the heated seats, do the following:

- Push control located on the instrument panel to set at high heat.
- Push control again to set at low heat.
- Push again to deactivate.

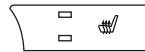

Seating and Safety Restraints

The indicator light on the control will illuminate when activated.

The system automatically shuts off after 10 minutes.

Heated and cooled seats (if equipped)

The controls for the climate controlled seats are located on the dual electronic automatic temperature control (DEATC) system.

Heated seats

 **WARNING:** Persons who are unable to feel pain to the skin because of advanced age, chronic illness, diabetes, spinal cord injury, medication, alcohol use, exhaustion, or other physical conditions, must exercise care when using the seat heater. The seat heater may cause burns even at low temperatures, especially if used for long periods of time. Do not place anything on the seat that insulates against heat, such as a blanket or cushion, because this may cause the seat heater to overheat. Do not puncture the seat with pins, needles, or other pointed objects because this may damage the heating element which may cause the seat heater to overheat. An overheated seat may cause serious personal injury.

Note: Do not do the following:

- Place heavy objects on the seat
- Operate the seat heater if water or any other liquid is spilled on the seat. Allow the seat to dry thoroughly.

The heated seats will only function when the engine is running.

To operate the heated seats:

Press once to activate the high heat setting (three indicator lights).

Continue pressing to scroll through the other settings; medium heat (two indicator lights), low heat (one indicator light) or off.

- DATC system



- Navigation-based system



Seating and Safety Restraints

Cooled seats

The cooled seats will only function when the engine is running.

To operate the cooled seats:

Press once to activate the high cool setting (three indicator lights). Continue pressing to scroll through the other settings; medium cool (two indicator lights), low cool (one indicator light) or off.

- DATC system



- Navigation-based system



If the engine falls below 350 RPMs while the cooled seats are on, the feature will turn itself off and will need to be reactivated.

Climate controlled seats air filter replacement (if equipped)

The climate controlled seat system includes air filters that must be replaced periodically. Refer to the *scheduled maintenance information* for more information.

- There is a filter located under the rear of each front seat.

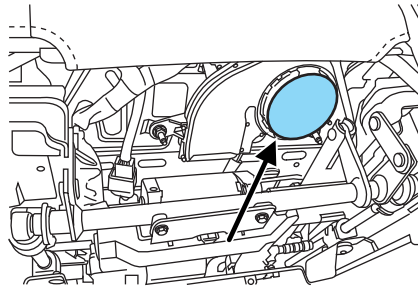

- The filter can be accessed from the second row seat. Move the front seats all the way forward and up to ease access.

Seating and Safety Restraints

To remove an air filter:

1. Remove key from ignition.
2. Push up on the outside rigid edge of the filter and rotate toward the front of the vehicle once tabs are released.

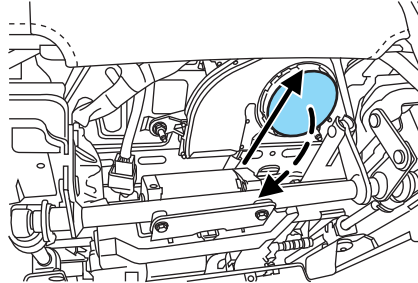

3. Remove filter.

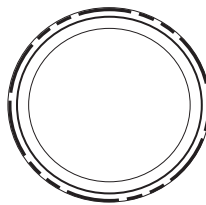

To install a filter:

- First, position the filter in its housing making sure that the far forward end is all the way up in the housing. Then push in on the center of the outside edge of the filter and rotate up into the housing until it clips into position.

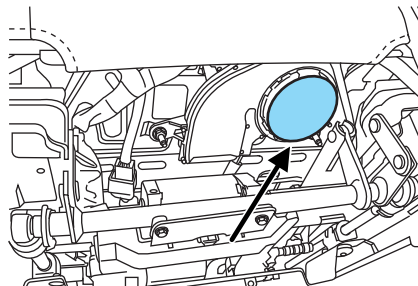

REAR SEATS

Second row head restraints

Your vehicle is equipped with 2nd row outboard head restraints that are vertically adjustable.

Seating and Safety Restraints

⚠ WARNING: To minimize the risk of neck injury in the event of a crash, the driver and passenger occupants should not sit in and/or operate the vehicle, until the head restraint is placed in its proper position. The driver should never adjust the head restraint while the vehicle is in motion.

The adjustable head restraints consist of :

- a trimmed energy absorbing foam and structure (1),
- two steel stems (2),
- a guide sleeve adjust/release button (3),
- and a guide sleeve unlock/remove button (4).

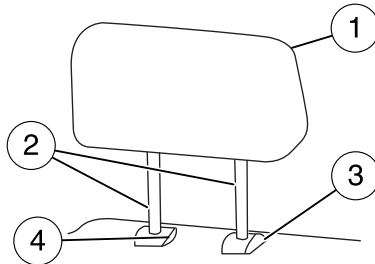

To adjust the head restraint, do the following:

1. Raise the head restraint by pulling up on the head restraint.

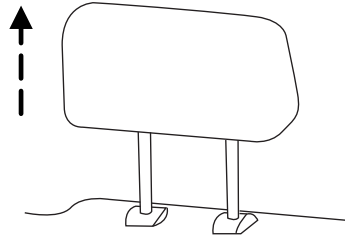

2. Lower the head restraint by pressing and holding the guide sleeve adjust/release button and pushing down on the head restraint.

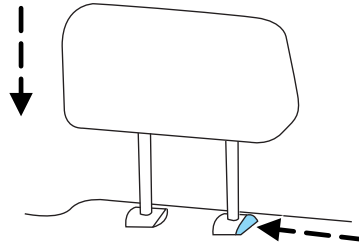

Seating and Safety Restraints

Properly adjust the head restraint so that the top of the head restraint is even with the top of your head and positioned as close as possible to the back of your head. For occupants of extremely tall stature, adjust the head restraint to its full up position.

 **WARNING:** The adjustable head restraint is a safety device. Whenever possible it should be installed and properly adjusted when the seat is occupied.

To remove the adjustable head restraint, do the following:

1. Pull up the head restraint until it reaches the highest adjustment position.

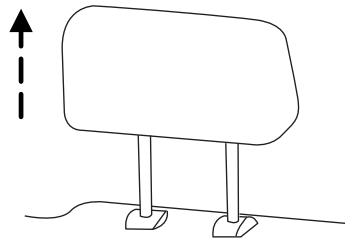

2. Simultaneously press and hold both the adjust/release button and the unlock/remove button, then pull up on the head restraint.

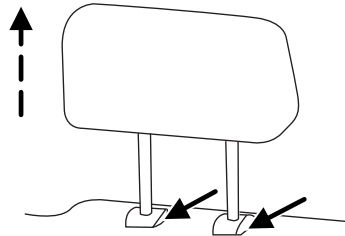

Seating and Safety Restraints

To reinstall the adjustable head restraint, do the following:

1. Insert the two stems into the guide sleeve collars.
2. Push the head restraint down until it locks.

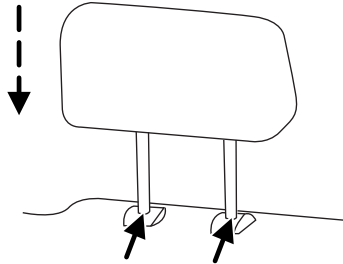

Properly adjust the head restraint so that the top of the head restraint is even with the top of your head and positioned as close as possible to the back of your head. For occupants of extremely tall stature, adjust the head restraint to its full up position.



WARNING: To minimize the risk of neck injury in the event of a crash, head restraints must be installed properly.

Folding up the rear seats (SuperCab only)

The rear seat has a split 60/40 cushion. Each seat cushion can be flipped up into a vertical storage position.

1. Pull control to release seat cushion.
2. Rotate seat cushion up until it locks into vertical storage position.

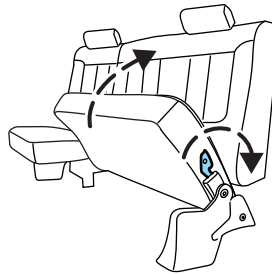

Returning the seat to seating position



WARNING: Make sure that cargo or any objects are not trapped underneath the seat cushion before returning the seat cushion to its original position, and that the seat cushion locks into place. Failure to do so may prevent the seat from operating properly in the event of a crash, which could increase the risk of serious injury.

Seating and Safety Restraints

1. Pull control on the side of the seat to release seat cushion from storage position.
2. Push seat cushion down until it locks into horizontal position.

Folding up the rear seats (CrewCab vehicles only)

The rear seat has a split 60/40 cushion. Each seat cushion can be flipped up into a vertical storage position.

- Rotate seat cushion up by lifting on the corner until it locks into vertical storage position.

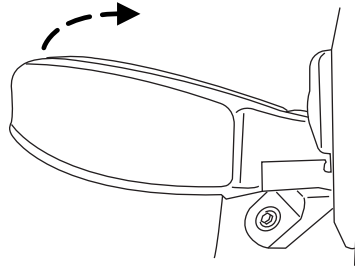

Returning the seat to seating position



WARNING: Before returning the seat cushion to its original position, make sure that cargo or any objects are not trapped underneath the seat cushion.

1. Pull control on the bottom of the seat cushion to release seat cushion from storage position.
2. Push seat cushion down until it rests into the horizontal position.

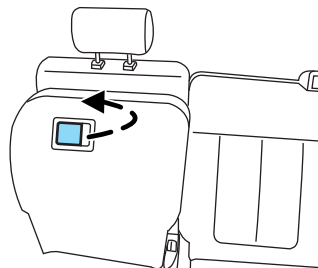

Seating and Safety Restraints

Armrest and cupholders (if equipped)

Pull the strap located on the center seatback to access the armrest and cupholders.

The cupholders are located inside the rear seat armrest. To open the cupholders:

- Push in gently on the center of the plastic panel on the front edge of the armrest. The cupholders will partially open.
- Pull the cupholder fully open before using.

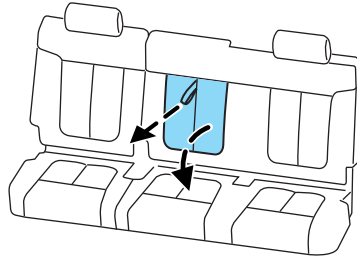

To close the cupholders:

- Push the front edge back into the seat until the cupholders are fully seated.
- Make sure there is nothing in the cupholders before attempting to close them.

Make sure that the cupholders are fully seated before stowing the armrest.

SAFETY RESTRAINTS

Personal Safety System®

The Personal Safety System® provides an improved overall level of frontal crash protection to front seat occupants and is designed to help further reduce the risk of airbag-related injuries. The system is able to analyze different occupant classifications and conditions and crash severity before activating the appropriate safety devices to help better protect a range of occupants in a variety of frontal crash situations.

Your vehicle's Personal Safety System® consists of:

- Driver and passenger dual-stage airbag supplemental restraints.
- Front outboard safety belts with pretensioners, energy management retractors, and safety belt usage sensors.
- Driver's seat position sensor.
- Front crash severity sensor.
- Front passenger sensing system
- Passenger Airbag Off indicator light.

Seating and Safety Restraints

- Restraints Control Module (RCM) with impact and safing sensors.
- Restraint system warning light and back-up tone.
- The electrical wiring for the airbags, crash sensor(s), safety belt pretensioners, front safety belt usage sensors, driver seat position sensor, and indicator lights.

How does the Personal Safety System® work?

The Personal Safety System® can adapt the deployment strategy of your vehicle's safety devices according to crash severity and occupant classification and conditions. A collection of crash and occupant sensors provides information to the Restraints Control Module (RCM). During a crash, the RCM may activate the safety belt pretensioners and/or either none, one, or both stages of the dual-stage airbag supplemental restraints based on crash severity and occupant classification and conditions.

The fact that the pretensioners or airbags did not activate for both front seat occupants in a collision does not mean that something is wrong with the system. Rather, it means the Personal Safety System® determined the accident conditions (crash severity, belt usage, etc.) were not appropriate to activate these safety devices. Front airbags are designed to activate only in frontal and near-frontal collisions, not rollovers, side-impacts, or rear-impacts unless the collision causes sufficient longitudinal deceleration.

Driver and passenger dual-stage airbag supplemental restraints

The dual-stage airbags offer the capability to tailor the level of airbag inflation energy. A lower, less forceful energy level is provided for more common, moderate-severity impacts. A higher energy level is used for the most severe impacts. Refer to *Airbag Supplemental Restraints (SRS)* section in this chapter.

Front crash severity sensor

The front crash severity sensor enhances the ability to detect the severity of an impact. Positioned up front, it provides valuable information early in the crash event on the severity of the impact. This allows your Personal Safety System® to distinguish between different levels of crash severity and modify the deployment strategy of the dual-stage airbags and safety belt pretensioners.

Driver's seat position sensor

The driver's seat position sensor allows your Personal Safety System® to tailor the deployment level of the driver dual-stage airbag based on seat position. The system is designed to help protect smaller drivers sitting close to the driver airbag by providing a lower airbag output level.

Seating and Safety Restraints

Front passenger sensing system

For airbags to do their job they must inflate with great force, and this force can pose a potentially deadly risk to occupants that are very close to the airbag when it begins to inflate. For some occupants, like infants in rear-facing child seats, this occurs because they are initially sitting very close to the airbag. For other occupants, this occurs when the occupant is not properly restrained by safety belts or child safety seats and they move forward during pre-crash braking. The most effective way to reduce the risk of unnecessary injuries is to make sure all occupants are properly restrained. Accident statistics suggest that children are much safer when properly restrained in the rear seating positions than in the front.



WARNING: Air bags can kill or injure a child in a child seat. **NEVER** place a rear-facing child seat in front of an active air bag. If you must use a forward-facing child seat in the front seat, move the seat all the way back.



WARNING: Always transport children 12 years old and under in the back seat and always properly use appropriate child restraints.



WARNING: When possible, all children 12 years old and under should be properly restrained in a rear seating position.

The front passenger sensing system can automatically turn off the passenger front airbag when a rear facing child seat, a forward-facing child restraint, or a booster seat is detected. Even with this technology, parents are **STRONGLY** encouraged to always properly restrain children in the rear seat. The sensor also turns off the passenger front airbag and passenger seat-mounted side airbag when the passenger seat is empty.

When the front passenger seat is occupied and the sensing system has turned off the passenger's frontal airbag, the "pass airbag off" indicator will light and stay lit to remind you that the front passenger frontal airbag is off. See *Front passenger sensing system* in the *Airbag supplemental restraint system (SRS)* section of this chapter.

Front safety belt usage sensors

The front safety belt usage sensors detect whether or not the driver and front outboard passenger safety belts are fastened. This information

Seating and Safety Restraints

allows your Personal Safety System® to tailor the airbag deployment and safety belt pretensioner activation depending upon safety belt usage. Refer to *Safety belt usage sensors* later in this chapter.

Front outboard safety belt pretensioners

The safety belt pretensioners at the front outboard seating positions are designed to tighten the safety belts firmly against the occupant's body during frontal collisions, and in side collisions and rollovers. This helps increase the effectiveness of the safety belts. In frontal collisions, the safety belt pretensioners can be activated alone or, if the collision is of sufficient severity, together with the front airbags.

Front outboard safety belt energy management retractors

The front outboard safety belt energy management retractors allow webbing to be pulled out of the retractor in a gradual and controlled manner in response to the occupant's forward momentum. This helps reduce the risk of force-related injuries to the occupant's chest by limiting the load on the occupant. Refer to *Energy management retractors* section in this chapter.

Determining if the Personal Safety System® is operational

The Personal Safety System® uses a warning light in the instrument cluster or a back-up tone to indicate the condition of the system. Refer to the *Warning lights and chimes* section in the *Instrument Cluster* chapter. Routine maintenance of the Personal Safety System® is not required.

The Restraints Control Module (RCM) monitors its own internal circuits and the circuits for the airbag supplemental restraints, crash sensor(s), safety belt pretensioners, front safety belt buckle sensors, and the driver seat position sensor. In addition, the RCM also monitors the restraints warning light in the instrument cluster. A difficulty with the system is indicated by one or more of the following.

- The warning light will either flash or stay lit.
- The warning light will not illuminate immediately after ignition is turned on.
- A series of five beeps will be heard. The tone pattern will repeat periodically until the problem and warning light are repaired.

If any of these things happen, even intermittently, have the Personal Safety System® serviced at an authorized dealer immediately. Unless serviced, the system may not function properly in the event of a collision.

Seating and Safety Restraints

Safety restraints precautions



WARNING: Always drive and ride with your seatback upright and the lap belt snug and low across the hips.



WARNING: To reduce the risk of injury, make sure children sit in a rear seating position where they can be properly restrained.



WARNING: Never let a passenger hold a child on his or her lap while the vehicle is moving. The passenger cannot protect the child from injury in a collision.



WARNING: All occupants of the vehicle, including the driver, should always properly wear their safety belts, even when an airbag supplemental restraint system (SRS) is provided.



WARNING: It is extremely dangerous to ride in a cargo area, inside or outside of a vehicle. In a collision, people riding in these areas are more likely to be seriously injured or killed. Do not allow people to ride in any area of your vehicle that is not equipped with seats and safety belts. Be sure everyone in your vehicle is in a seat and using a safety belt properly.



WARNING: In a rollover crash, an unbelted person is significantly more likely to die than a person wearing a safety belt.





WARNING: Each seating position in your vehicle has a specific safety belt assembly which is made up of one buckle and one tongue that are designed to be used as a pair. 1) Use the shoulder belt on the outside shoulder only. Never wear the shoulder belt under the arm. 2) Never swing the safety belt around your neck over the inside shoulder. 3) Never use a single belt for more than one person.



WARNING: When possible, all children 12 years old and under should be properly restrained in a rear seating position.

Seating and Safety Restraints

 **WARNING:** Safety belts and seats can become hot in a vehicle that has been closed up in sunny weather; they could burn a small child. Check seat covers and buckles before you place a child anywhere near them.

 **WARNING:** Front and rear seat occupants, including pregnant women, should wear safety belts for optimum protection in an accident.

Combination lap and shoulder belts

1. Insert the belt tongue into the proper buckle (the buckle closest to the direction the tongue is coming from) until you hear a snap and feel it latch. Make sure the tongue is securely fastened in the buckle.

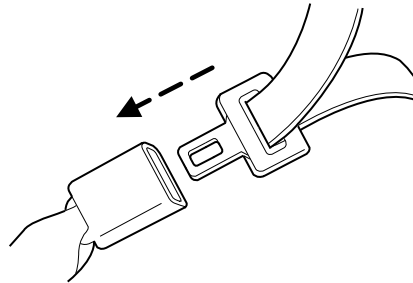

2. To unfasten, push the release button and remove the tongue from the buckle.

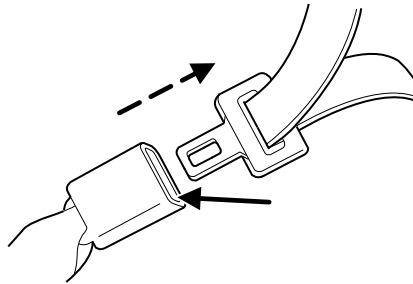

Seating and Safety Restraints

Center front safety belt (Regular Cab center and CrewCab rear center seating positions only)



WARNING: Always use both lap and shoulder safety belt in the Regular Cab center seating position.

If you carry large cargo behind the seat or items that might damage or soil the belt, detach the belt from the seat:

- Release the mini-buckle by inserting a key or similar object into the slot.

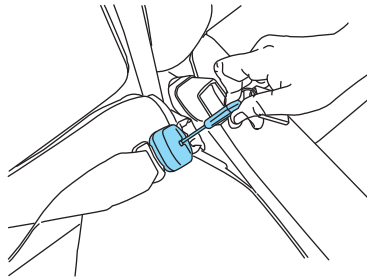

If the belt has been disconnected to carry large objects behind the seat, reconnect it as follows:

- Buckle the small tongue on the end of the belt into the mini-buckle on the driver's side. The belt is now ready for use. This mini-buckle should stay buckled at all times unless cargo-carrying makes it necessary to detach the belt.

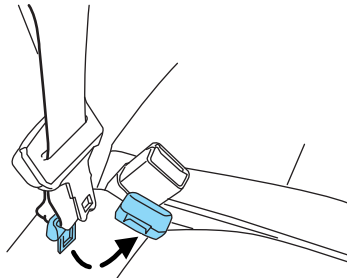

Safety belt with cinch tongue (Regular Cab center only)

The cinch tongue will slide up and down the belt webbing when the belt is stowed or while putting safety belts on. When the lap/shoulder safety belt is buckled, the cinch tongue will allow the lap portion to be shortened, but pinches the webbing to keep the lap portion from getting longer. The cinch tongue is designed to slip during a crash, so always wear the shoulder belt properly and don't allow any slack in either the lap or shoulder portions.

Seating and Safety Restraints

Before you can reach and latch a combination lap and shoulder belt having a cinch tongue into the buckle, you may have to lengthen the lap belt portion of it.

1. To lengthen the lap belt, pull some webbing out of the shoulder belt retractor.
2. While holding the webbing below the tongue, grasp the tip (metal portion) of the tongue so that it is parallel to the webbing and slide the tongue upward.

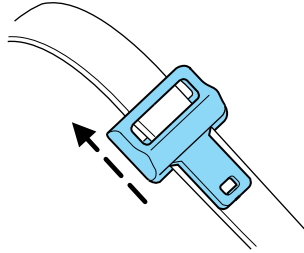

3. Provide enough lap belt length so that the tongue can reach the buckle.

How to fasten the cinch tongue (Regular Cab center only)

1. Pull the combination lap and shoulder belt from the retractor so that the shoulder belt portion of the safety belt crosses your shoulder and chest.
2. Be sure the belt is not twisted. If the belt is twisted, remove the twist.
3. Insert the belt tongue into the proper buckle for your seating position until you hear a snap and feel it latch.
4. Make sure the tongue is securely fastened to the buckle by pulling on the tongue.



WARNING: The lap belt should fit snugly and as low as possible around the hips, not across the waist.



WARNING: Front and rear seat occupants, including pregnant women, should wear safety belts for optimum protection in an accident.



WARNING: Each seating position in your vehicle has a specific safety belt assembly which is made up of one buckle and one tongue that are designed to be used as a pair. 1) Use the shoulder belt on the outside shoulder only. Never wear the shoulder belt under the arm. 2) Never swing the safety belt around your neck over the inside shoulder. 3) Never use a single belt for more than one person.

Seating and Safety Restraints

While you are fastened in the safety belt, the combination lap/shoulder belt with a cinch tongue adjusts to your movement. However, if you brake hard, turn hard, or if your vehicle receives an impact of 5 mph (8 km/h) or more, the safety belt will become locked and help reduce your forward movement.

Lap belts

Adjusting the lap belt **(Front center seat position SuperCab and CrewCab only)**

 **WARNING:** The lap belt should fit snugly and as low as possible around the hips, not across the waist.

The front center lap belt tongue is designed to fit only in the correct buckle. The tongue will not securely latch if you attempt to use it in any of the outboard seating position buckles. To ensure that you have used the correct buckle you should hear a snap and feel it latch.

• **Front center lap belt**

The lap belt does not adjust automatically.

Insert the tongue into the correct buckle (the buckle closest to the direction the tongue is coming from). To lengthen the belt, turn the tongue at a right angle to the belt and pull across your lap until it reaches the buckle. To tighten the belt, pull the loose end of the belt through the tongue until it fits snugly across the hips.

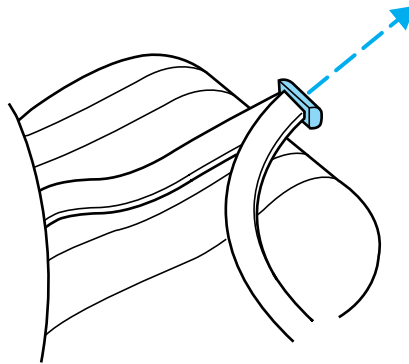

Seating and Safety Restraints

Shorten and fasten the belt when not in use.

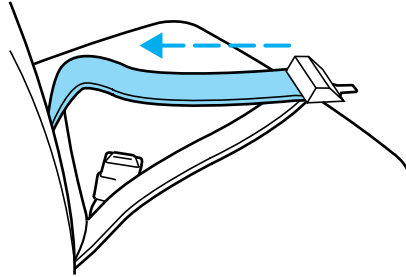

For long term storage, the lap belt can be placed into a pocket found on the inside lid of the storage compartment. To store the lap belt, do the following:

1. Open the storage compartment lid.

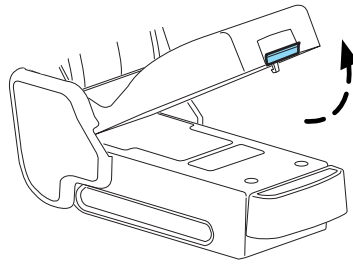

2. Place the lap belt into the pocket found on the inside lid of the storage compartment.

3. Fold the center buckle into the storage compartment.

4. Close the lid.

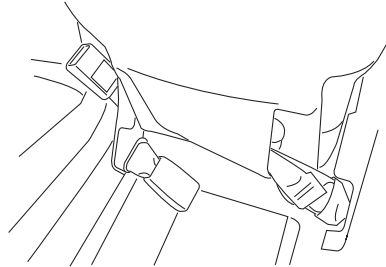

Before a passenger sits in the front center seat, make sure the lap belt and buckle are both placed in their in-use position, and no longer stowed. Always fasten your seat belt when riding in the front center seat.

Energy management retractors

Your vehicle has a safety belt system equipped with energy management retractors at the driver and front outboard passenger seating positions.

Seating and Safety Restraints

An energy management retractor is a device which pays out webbing in a controlled manner. This feature is designed to help further reduce the risk of force-related injuries to the occupant.

Safety belt systems equipped with an energy management retractor must be replaced if they were in use during a frontal collision which resulted in deployment of the frontal airbags. Refer to the *Safety belt maintenance* section in this chapter.

The front and rear safety restraints in the vehicle are combination lap and shoulder belts. The front passenger outboard and rear outboard seat safety belts have two types of locking modes described below:

Vehicle sensitive mode

The vehicle sensitive mode is the normal retractor mode, allowing free shoulder belt length adjustment to your movements and locking in response to vehicle movement. For example, if the driver brakes suddenly or turns a corner sharply, or the vehicle receives an impact of approximately 5 mph (8 km/h) or more, the combination safety belts will lock to help reduce forward movement of the driver and passengers.

The front outboard safety belts can also be made to lock manually by quickly pulling on the shoulder belt. Rear safety belts (if equipped) can also be made to lock up by pulling quickly on the belt.

Automatic locking mode

In this mode, the shoulder belt is automatically pre-locked. The belt will still retract to remove any slack in the shoulder belt.

The automatic locking mode is not available on the driver safety belt, or the Regular Cab center safety belt.

When to use the automatic locking mode

- **Anytime** a child safety seat is installed in a front outboard passenger seating position in a Regular Cab/ SuperCab/ SuperCrew or any rear seating position of a SuperCab or SuperCrew. The Regular Cab front center seatbelt has a cinch mechanism. Refer to *Safety belt with cinch tongue (Regular Cab center only)* earlier in this chapter. Children 12 years old and under should be properly restrained in a rear seat whenever possible. Refer to *Safety restraints for children* or *Safety seats for children* later in this chapter.

Seating and Safety Restraints

How to use the automatic locking mode

1. Buckle the combination lap and shoulder belt.

- Right front passenger seat

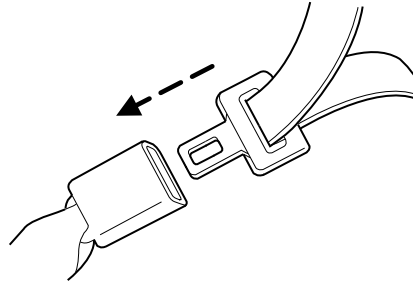

- Rear seats (if equipped)

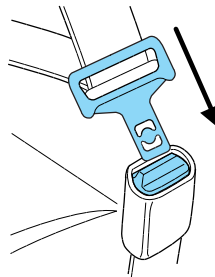

2. Grasp the shoulder portion and pull downward until the entire belt is extracted.





3. Allow the belt to retract. As the belt retracts, you will hear a clicking sound. This indicates the safety belt is now in the automatic locking mode.

How to disengage the automatic locking mode

Disconnect the combination lap/shoulder belt and allow it to retract completely to disengage the automatic locking mode and activate the vehicle sensitive (emergency) locking mode.

Seating and Safety Restraints

 **WARNING:** After any vehicle collision, the safety belt systems at all seating positions (except the driver position, which does not have this feature) must be checked by an authorized dealer to verify that the automatic locking retractor feature for child seats is still functioning properly. In addition, all safety belts should be checked for proper function.

 **WARNING:** BELT AND RETRACTOR ASSEMBLY MUST BE REPLACED if the safety belt assembly “automatic locking retractor” feature or any other safety belt function is not operating properly when checked by an authorized dealer. Failure to replace the Belt and Retractor assembly could increase the risk of injury in collisions.

Safety belt pretensioner

Your vehicle is equipped with safety belt pretensioners at the driver and right front passenger seating positions.

The safety belt pretensioner removes some slack from the safety belt system at the start of a crash. The safety belt pretensioner uses the same crash sensor system as the front airbags and Safety Canopy® system. When the safety belt pretensioner deploys, the lap and shoulder belt are tightened.

When the Safety Canopy® system and/or the front airbags are activated, the safety belt pretensioners for the driver and right front passenger seating positions will be activated when the respective seatbelt is properly buckled.

 **WARNING:** The driver and the right front passenger safety belt system (including retractors, buckles and height adjusters) must be replaced if the vehicle is involved in a collision that results in deployment of front airbags or Safety Canopy® and safety belt pretensioners.

 **WARNING:** Failure to replace the safety belt assembly under the above conditions could result in severe personal injuries in the event of a collision.

Refer to the *Safety belt maintenance* section in this chapter.

Seating and Safety Restraints

Safety belt usage sensors

The driver and front outboard passenger safety belt buckles are equipped with sensors that detect if the safety belts are fastened. The sensors provide information to the Personal Safety System® which can then adapt the airbag deployment or safety belt pretensioner activation based upon safety belt usage.

 **WARNING:** The Personal Safety System® provides the most benefit to belted occupants. The system monitors and tailors the air bag deployment based upon safety belt usage. Failure to properly wear your safety belt will increase your risk of injury.

Front safety belt height adjustment

Your vehicle has safety belt height adjustments at the front outboard seating positions. Adjust the height of the shoulder belt so the belt rests across the middle of your shoulder.

To adjust the shoulder belt height, pull on the center button and slide the height adjuster up or down. Release the button and pull down on the height adjuster to make sure it is locked in place.

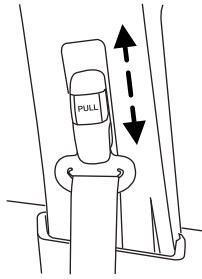

 **WARNING:** Position the safety belt height adjusters so that the belt rests across the middle of your shoulder. Failure to adjust the safety belt properly could reduce the effectiveness of the safety belt and increase the risk of injury in a collision.

Safety belt warning light and indicator chime

The safety belt warning light illuminates in the instrument cluster and a chime sounds to remind the occupants to fasten their safety belts.

Seating and Safety Restraints

Conditions of operation

If...	Then...
The driver's safety belt is not buckled before the ignition switch is turned to the on position...	The safety belt warning light illuminates 1-2 minutes and the warning chime sounds 4-8 seconds.
The driver's safety belt is buckled while the indicator light is illuminated and the warning chime is sounding...	The safety belt warning light and warning chime turn off.
The driver's safety belt is buckled before the ignition switch is turned to the on position...	The safety belt warning light and indicator chime remain off.

Belt-Minder®

The Belt-Minder® feature is a supplemental warning to the safety belt warning function. This feature provides additional reminders by intermittently sounding a chime and illuminating the safety belt warning lamp in the instrument cluster when the driver's and front passenger's safety belt is unbuckled.

The Belt-Minder® feature uses information from the front passenger sensing system to determine if a front seat passenger is present and therefore potentially in need of a warning. To avoid activating the Belt-Minder® feature for objects placed in the front passenger seat, warnings will only be given to large front seat occupants as determined by the front passenger sensing system.

Both the driver's and passenger's safety belt usages are monitored and either may activate the Belt-Minder® feature. The warnings are the same for the driver and the front passenger. If the Belt-Minder® warnings have expired (warnings for approximately five minutes) for one occupant (driver or front passenger), the other occupant can still activate the Belt-Minder® feature.

When the Belt-Minder® feature is activated, the safety belt warning light illuminates and the warning chime sounds for six seconds every 30 seconds, repeating for approximately five minutes or until the safety belts are buckled.

Seating and Safety Restraints

The Belt-Minder® feature uses two different warning chimes. During the first minute of activation, the warning chime will sound once every second. The remaining warning chimes will sound twice every second while the system is activated.

If...	Then...
The driver's and front passenger's safety belts are buckled...	The Belt-Minder® feature will not activate.
The driver's or front passenger's safety belt is not buckled when the vehicle has reached at least 6 mph and 1-2 minutes have elapsed since the ignition switch has been turned to ON...	The Belt-Minder® feature is activated - the safety belt warning light illuminates and the warning chime sounds for six seconds every 30 seconds, repeating for approximately five minutes or until the safety belts are buckled.
The driver's or front passenger's safety belt becomes unbuckled for approximately 1 minute while the vehicle is traveling at least 6 mph and 1-2 minutes have elapsed since the ignition switch has been turned to ON...	The Belt-Minder® feature is activated - the safety belt warning light illuminates and the warning chime sounds for six seconds every 30 seconds, repeating for approximately five minutes or until the safety belts are buckled.
The Belt-Minder® feature is activated and the vehicle speed is less than 3 mph...	The Belt-Minder® feature is suspended - the safety belt warning light remains illuminated, but the warning chime does not sound. This time does not count towards the five-minute expiration time.

Seating and Safety Restraints

The following are reasons most often given for not wearing safety belts:
(All statistics based on U.S. data)

Reasons given...	Consider...
"Crashes are rare events"	36700 crashes occur every day. The more we drive, the more we are exposed to "rare" events, even for good drivers. <i>1 in 4 of us will be seriously injured in a crash during our lifetime.</i>
"I'm not going far"	3 of 4 fatal crashes occur within 25 miles of home.
"Belts are uncomfortable"	We design our safety belts to enhance comfort. If you are uncomfortable - try different positions for the safety belt upper anchorage and seatback which should be as upright as possible; this can improve comfort.
"I was in a hurry"	Prime time for an accident. Belt-Minder® reminds us to take a few seconds to buckle up.
"Safety belts don't work"	Safety belts , when used properly, reduce risk of death to front seat occupants by 45% in cars , and by 60% in light trucks.
"Traffic is light"	Nearly 1 of 2 deaths occur in single-vehicle crashes , many when no other vehicles are around.
"Belts wrinkle my clothes"	Possibly, but a serious crash can do much more than wrinkle your clothes, particularly if you are unbelted.
"The people I'm with don't wear belts"	Set the example, teen deaths occur 4 times more often in vehicles with TWO or MORE people. Children and younger brothers/sisters imitate behavior they see.

Seating and Safety Restraints

Reasons given...	Consider...
"I have an airbag"	Airbags offer greater protection when used with safety belts. Frontal airbags are not designed to inflate in rear and side crashes or rollovers.
"I'd rather be thrown clear"	Not a good idea. People who are ejected are 40 times more likely to DIE. Safety belts help prevent ejection, WE CAN'T "PICK OUR CRASH".



WARNING: Do not sit on top of a buckled safety belt or insert a latchplate into the buckle to avoid the Belt-Minder® chime. To do so may adversely affect the performance of the vehicle's air bag system.

One time disable

If at any time the driver/front passenger quickly buckles then unbuckles the Belt-Minder® feature for that seating position, the Belt-Minder™ is disabled for the current ignition cycle. The Belt-Minder® feature will re-enable during the same ignition cycle if the occupant buckles and remains buckled for approximately 30 seconds. Confirmation is not given for the one time disable.

Deactivating/activating the Belt-Minder® feature

The driver and front passenger Belt-Minder® are deactivated/activated independently. When deactivating/activating one seating position, do not buckle the other position as this will terminate the process.

Read Steps 1 - 4 thoroughly before proceeding with the deactivation/activation programming procedure.

The driver and front passenger Belt-Minder® features can be deactivated/activated by performing the following procedure:

Before following the procedure, make sure that:

- The parking brake is set
- The gearshift is in P (Park)
- The ignition switch is in the off position
- The driver and front passenger safety belts are unbuckled

Seating and Safety Restraints



WARNING: While the design allows you to deactivate your Belt-Minder®, this system is designed to improve your chances of being safely belted and surviving an accident. We recommend you leave the Belt-Minder® system activated for yourself and others who may use the vehicle. To reduce the risk of injury, do not deactivate/activate the Belt-Minder® feature while driving the vehicle.

1. Turn the ignition switch to the on position. **DO NOT START THE ENGINE.**
2. Wait until the safety belt warning light turns off. (Approximately one minute)
 - Step 3 must be completed within 50 seconds after the safety belt warning light turns off.
3. For the seating position being disabled, buckle then unbuckle the safety belt nine times, ending in the unbuckled state. (Step 3 must be completed within 50 seconds after the safety belt warning light turns off.)
 - After Step 3, the restraint system warning light (airbag light) will be turned on for three seconds.
4. Within approximately seven seconds of the light turning off, buckle then unbuckle the safety belt.
 - This will disable the Belt-Minder® feature for that seating position if it is currently enabled. As confirmation, the restraint system warning light will flash four times per second for three seconds.
 - This will enable the Belt-Minder® feature for that seating position if it is currently disabled. As confirmation, the restraint system warning light will flash four times per second for three seconds, followed by three seconds with the light off, then followed by the restraint system warning light flashing four times per second for three seconds again.

Safety belt extension assembly

If the safety belt is too short when fully extended, there is an 8 inch (20 cm) safety belt extension assembly that can be added (part number 611C22). This assembly can be obtained from an authorized dealer.

Use only extensions manufactured by the same supplier as the safety belt. Manufacturer identification is located at the end of the webbing on the label. Also, use the safety belt extension only if the safety belt is too short for you when fully extended.

Seating and Safety Restraints



WARNING: Do not use extensions to change the fit of the shoulder belt across the torso.

AIRBAG SUPPLEMENTAL RESTRAINT SYSTEM (SRS)

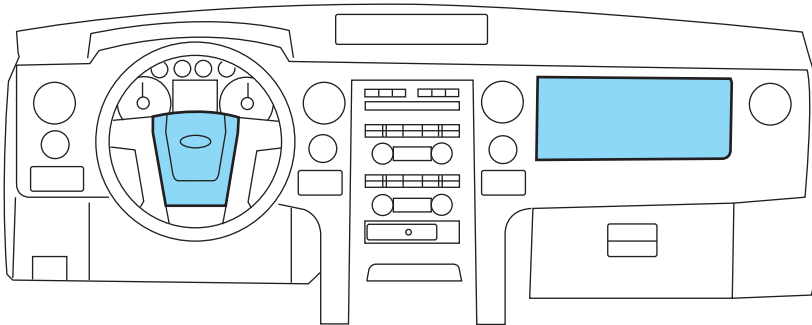

The airbag supplemental restraint system is designed to work in conjunction with the safety belts to help protect the driver and front outboard passenger from certain upper body injuries. The term “supplemental restraint” means the airbags are intended as a supplement to the safety belts. Airbags alone cannot protect as well as airbags plus safety belts in impacts for which the airbags are designed to deploy, and airbags do not offer any protection in crashes for which they do not deploy.

The airbag supplemental restraint system consists of:

- driver and passenger dual stage airbag modules (which include the inflators and airbags).
- side airbags and Safety Canopy®. Refer to *Seat-mounted side airbag system* and *Safety Canopy® system* later in this chapter.
- one or more impact and safing sensors.
- the same indicator light, RCM (restraints control module) and diagnostic unit used for the Personal safety system.
- Front passenger sensing system
- Passenger airbag off indicator light.

The airbag supplemental restraints are an integral part of the Personal Safety System. They are designed to be deployed in cases where the

Seating and Safety Restraints

Personal Safety System has determined the occupant conditions and crash severity are appropriate to activate these devices. Refer to the *Personal Safety System*[™] section in this chapter.



WARNING: The front passenger airbag is not designed to offer protection to an occupant in the center front seating position.



WARNING: Modifying or adding equipment to the front end of the vehicle (including frame, bumper, front end body structure and tow hooks) may affect the performance of the airbag system, increasing the risk of injury. Do not modify the front end of the vehicle.



WARNING: Additional equipment may affect the performance of the airbag sensors increasing the risk of injury.

Children and airbags

For additional important safety information, read all information on safety restraints in this guide.

Children must always be properly restrained. Accident statistics suggest that children are safer when properly restrained in the rear seat than in the front seat. Failure to follow these instructions may increase the risk of injury in a collision.



WARNING: Airbags can kill or injure a child in a child seat. **NEVER** place a rear-facing child seat in front of an active airbag. If you must use a forward-facing child seat in the front seat, move the seat all the way back.

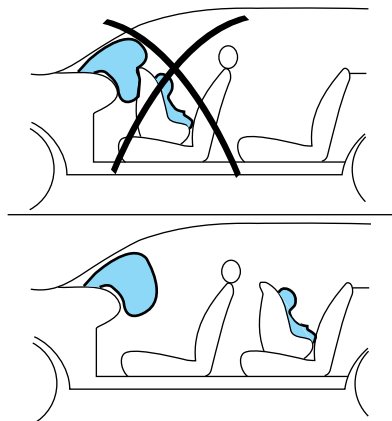

Seating and Safety Restraints

If two adults and a child occupy a **Regular Cab**, properly restrain the child in the center front unless doing so would interfere with driving the vehicle. This arrangement provides lap and shoulder belt protection for all occupants, and airbag protection for the adults. All occupants of the vehicle should always properly wear their safety belts. Ensure the child is properly restrained in an appropriate child seat or with the use of a booster. A child or infant properly restrained in the center front seat should not incur risk of serious injury from the airbags.

How does the airbag supplemental restraint system work?

The airbag SRS is designed to activate when the vehicle sustains sufficient longitudinal deceleration.

The fact that the airbags did not inflate in a collision does not mean that something is wrong with the system. Rather, it means the forces were not of the type sufficient to cause activation. Airbags are designed to inflate in frontal and near-frontal collisions, not rollover, side-impacts, or rear-impacts.

The airbags inflate and deflate rapidly upon activation. After airbag deployment, it is normal to notice a smoke-like, powdery residue or smell the burnt propellant. This may consist of cornstarch, talcum powder (to lubricate the bag) or sodium compounds (e.g., baking soda) that result from the combustion process that inflates the airbag. Small amounts of sodium hydroxide may be present which may irritate the skin and eyes, but none of the residue is toxic.

While the system is designed to help reduce serious injuries, it may also cause minor abrasions, swelling or temporary hearing loss. Because airbags must inflate rapidly and with considerable force, there is the risk of death or serious injuries such as fractures, facial and eye injuries or

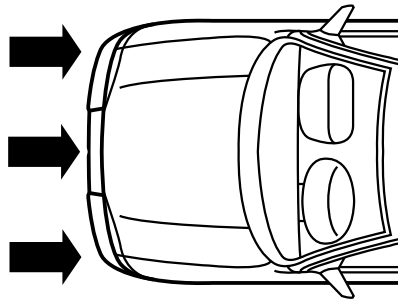

Seating and Safety Restraints

internal injuries, particularly to occupants who are not properly restrained or are otherwise out of position at the time of airbag deployment. Thus, it is extremely important that occupants be properly restrained as far away from the airbag cover as possible while maintaining vehicle control.



WARNING: Several airbag system components get hot after inflation. Do not touch them after inflation.



WARNING: If the airbag has deployed, **the airbag will not function again and must be replaced immediately.** If the airbag is not replaced, the unrepaired area will increase the risk of injury in a collision.

Determining if the system is operational

The SRS uses readiness lights in the instrument cluster or a tone to indicate the condition of the system. Refer to *Airbag readiness* in the *Instrument Cluster* chapter. Routine maintenance of the airbag is not required.

A difficulty with the system is indicated by one or more of the following:

- The readiness lights will either flash or stay lit.
- The readiness lights will not illuminate immediately after ignition is turned on.
- A series of five beeps will be heard. The tone pattern will repeat periodically until the problem and/or light are repaired.



If any of these things happen, even intermittently, have the SRS serviced at an authorized dealer immediately. Unless serviced, the system may not function properly in the event of a collision.

Front passenger sensing system

The front passenger sensing system is designed to meet the regulatory requirements of Federal Motor Vehicle Safety Standard (FMVSS) 208 and is designed to disable (will not inflate) the front passenger's frontal airbag under certain conditions.

The front passenger sensing system works with sensors that are part of the front passenger's seat and safety belt. The sensors are designed to

Seating and Safety Restraints

detect the presence of a properly seated occupant and determine if the front passenger's frontal airbag should be enabled (may inflate) or disabled (will not inflate).

The front passenger sensing system will disable (will not inflate) the front passenger's frontal airbag if:

- the front passenger seat is unoccupied, or has small/medium objects in the front seat,
- the system determines that an infant is present in a rear-facing infant seat that is installed according to the manufacturer's instructions,
- the system determines that a small child is present in a forward-facing child restraint that is installed according to the manufacturer's instructions,
- the system determines that a small child is present in a booster seat,
- a front passenger takes his/her weight off of the seat for a period of time,
- a child or a small person occupies the front passenger seat.

The front passenger sensing system will turn off the passenger seat side airbag if:

- the seat is empty and safety belt is unbuckled.

The front passenger sensing system uses a "passenger airbag off" or "pass airbag off" indicator which will illuminate and stay lit to remind you that the front passenger frontal airbag is disabled. The indicator lamp is located in the center stack of the instrument panel just above the radio.



Note: The indicator lamp will illuminate for a short period of time when the ignition is turned to the on position to confirm it is functional.

When the front passenger seat is not occupied (empty seat) or in the event that the front passenger frontal airbag is enabled (may inflate), the indicator lamp will be unlit.

The front passenger sensing system is designed to disable (will not inflate) the front passenger's frontal airbag when a rear facing infant seat, a forward-facing child restraint, or a booster seat is detected.

- When the front passenger sensing system disables (will not inflate) the front passenger frontal airbag, the indicator lamp will illuminate and stay lit to remind you that the front passenger frontal airbag is disabled.

Seating and Safety Restraints

- If the child restraint has been installed and the indicator lamp is not lit, then turn the vehicle off, remove the child restraint from the vehicle and reinstall the restraint following the child restraint manufacturer's instructions.

The front passenger sensing system is designed to enable (may inflate) the front passenger's frontal airbag anytime the system senses that a person of adult size is sitting properly in the front passenger seat.

- When the front passenger sensing system enables the front passenger frontal airbag (may inflate), the indicator will be unlit and stay unlit.

If a person of adult size is sitting in the front passenger's seat, but the "passenger airbag off" or "pass airbag off" indicator lamp is lit, it is possible that the person isn't sitting properly in the seat. If this happens:

- Turn the vehicle off and ask the person to place the seatback in the full upright position.
- Have the person sit upright in the seat, centered on the seat cushion, with the person's legs comfortably extended.
- Restart the vehicle and have the person remain in this position for about two minutes. This will allow the system to detect that person and enable the passenger's frontal airbag.
- If the indicator lamp remains lit even after this, the person should be advised to ride in the rear seat.

Occupant	Pass Airbag Off Indicator Lamp	Passenger Airbag
Empty seat	Unlit	Disabled
Small child in child safety seat or booster	Lit	Disabled
Small child with safety belt buckled or unbuckled	Lit	Disabled
Adult	Unlit	Enabled



WARNING: Even with Advanced Restraints Systems, children 12 and under should be properly restrained in a rear seating position.

After all occupants have adjusted their seats and put on safety belts, it's very important that they continue to sit properly. A properly seated occupant sits upright, leaning against the seat back, and centered on the

Seating and Safety Restraints

seat cushion, with their feet comfortably extended on the floor. Sitting improperly can increase the chance of injury in a crash event. For example, if an occupant slouches, lies down, turns sideways, sits forward, leans forward or sideways, or puts one or both feet up, the chance of injury during a crash is greatly increased.



WARNING: Sitting improperly out of position or with the seat back reclined too far can take off weight from the seat cushion and affect the decision of the front passenger sensing system, resulting in serious injury or death in a crash. Always sit upright against your seatback, with your feet on the floor.

The front passenger sensing system may detect small or medium objects placed on the seat cushion. For most objects that are in the front passenger seat, the passenger airbag will be disabled. Even though the passenger airbag is disabled, the "pass airbag off" lamp may or may not be illuminated according to the table below.

Objects	Pass Airbag Off Indicator Lamp	Passenger Airbag
Small (i.e. three-ring binder, small purse, bottled water)	Unlit	Disabled
Medium (i.e. heavy briefcase, fully packed luggage)	Lit	Disabled
Empty seat, or small to medium object with safety belt buckled	Lit	Disabled

In case there is a problem with the front passenger sensing system, the airbag readiness lamp in the instrument cluster will stay lit.



DO NOT attempt to repair or service the system; take your vehicle immediately to an authorized dealer.



WARNING: The front passenger airbag is not designed to offer protection to an occupant in the center seating position.

Seating and Safety Restraints



WARNING: An out of position front center occupant could affect the decision of the front passenger sensing system.

If it is necessary to modify an advanced front airbag system to accommodate a person with disabilities, contact the Ford Customer Relationship Center at the phone number shown in the *Customer Assistance* section of this *Owner's Guide*.



WARNING: Any alteration/modification to the front passenger seat may affect the performance of the front passenger sensing system.

Seat-mounted side airbag system



WARNING: Do not place objects or mount equipment on or near the airbag cover on the side of the seatbacks of the front seats or in front seat areas that may come into contact with a deploying airbag. Failure to follow these instructions may increase the risk of personal injury in the event of a collision.



WARNING: Do not use accessory seat covers. The use of accessory seat covers may prevent the deployment of the side airbags and increase the risk of injury in an accident.



WARNING: Do not lean your head on the door. The side airbag could injure you as it deploys from the side of the seatback.



WARNING: Do not attempt to service, repair, or modify the airbag SRS, its fuses or the seat cover on a seat containing an airbag. See an authorized dealer.



WARNING: All occupants of the vehicle should always wear their safety belts even when an airbag SRS is provided.

Seating and Safety Restraints

How does the side airbag system work?

The design and development of the side airbag system included recommended testing procedures that were developed by a group of automotive safety experts known as the Side Airbag Technical Working Group. These recommended testing procedures help reduce the risk of injuries related to the deployment of side airbags.

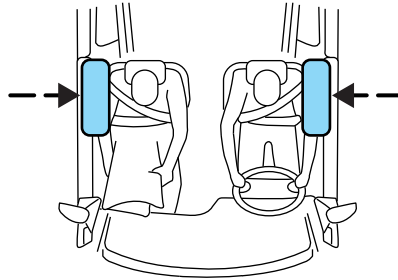

The side airbag system consists of the following:

- An inflatable nylon bag (airbag) with a gas generator concealed behind the outboard bolster of the driver and front passenger seatbacks.
- A special seat cover designed to allow airbag deployment.
- The same warning light, electronic control and diagnostic unit as used for the front airbags.
- Two crash sensors located on the lower portion of the b-pillar (one on each side of the vehicle).

Side airbags, in combination with safety belts, can help reduce the risk of severe injuries in the event of a significant side impact collision.

The side airbags are fitted on the outboard side of the seatbacks of the front seats. In certain lateral collisions, the airbag on the side affected by the collision will be inflated. If the front passenger sensing system detects an empty seat, the front passenger seat-mounted side airbag will be deactivated. The airbag was designed to inflate between the door panel and occupant to further enhance the protection provided occupants in side impact collisions.

The airbag SRS is designed to activate when the vehicle sustains lateral deceleration sufficient to cause the sensors to close an electrical circuit that initiates airbag inflation.

The fact that the airbags did not inflate in a collision does not mean that something is wrong with the system. Rather, it means the forces were not of the type sufficient to cause activation. Side airbags are designed to inflate in side-impact collisions, not roll-over, rear-impact, frontal or near-frontal collisions, unless the collision causes sufficient lateral deceleration.

Seating and Safety Restraints



WARNING: Several airbag system components get hot after inflation. Do not touch them after inflation.



WARNING: If the side airbag has deployed, **the airbag will not function again. The side airbag system (including the seat) must be inspected and serviced by an authorized dealer.** If the airbag is not replaced, the unrepaired area will increase the risk of injury in a collision.

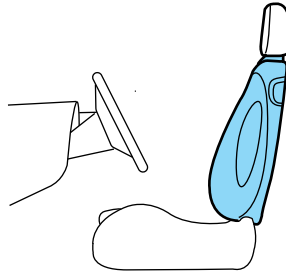

Determining if the system is operational

The SRS uses a readiness light in the instrument cluster or a tone to indicate the condition of the system. Refer to the *Airbag readiness* section in the *Instrument Cluster* chapter. Routine maintenance of the side airbag is not required.

A difficulty with the system is indicated by one or more of the following:

- The readiness light (same light as for front airbag system) will either flash or stay lit.
- The readiness light will not illuminate immediately after ignition is turned on.
- A series of five beeps will be heard. The tone pattern will repeat periodically until the problem and/or light are repaired.

If any of these things happen, even intermittently, have the SRS serviced at your authorized dealer immediately. Unless serviced, the system may not function properly in the event of a collision.

Seating and Safety Restraints

Safety Canopy® system

 **WARNING:** Do not place objects or mount equipment on or near the headliner at the siderail that may come into contact with a deploying Safety Canopy®. Failure to follow these instructions may increase the risk of personal injury in the event of a collision.

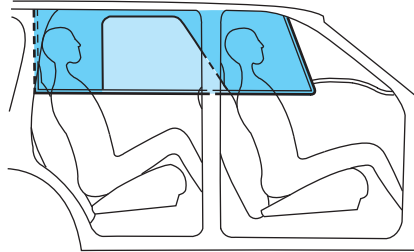

 **WARNING:** Do not lean your head on the door. The Safety Canopy® could injure you as it deploys from the headliner.

 **WARNING:** Do not attempt to service, repair, or modify the Safety Canopy® system, its fuses, the A, B, or C pillar trim, or the headliner on a vehicle containing a Safety Canopy®. Contact your authorized dealer as soon as possible.

 **WARNING:** All occupants of the vehicle including the driver should always wear their safety belts even when an airbag SRS and Safety Canopy® system is provided.

 **WARNING:** To reduce risk of injury, do not obstruct or place objects in the deployment path of the inflatable Safety Canopy®.

Seating and Safety Restraints

How does the Safety Canopy® system work?

The design and development of the Safety Canopy® system included recommended testing procedures that were developed by a group of automotive safety experts known as the Side Airbag Technical Working Group. These recommended testing procedures help reduce the risk of injuries related to the deployment of side airbags (including the Safety Canopy®).

The Safety Canopy® system consists of the following:

- An inflatable nylon curtain with a gas generator concealed behind the headliner and in the corner or C pillar behind the doors.
- A headliner designed to flex open above the side doors to allow Safety Canopy® deployment.
- The same warning light, electronic control and diagnostic unit as used for the front airbags.
- Two crash sensors located on the C-pillar (one on each side) (SuperCab and CrewCab only).
- Crash sensors located on the front doors.
- Rollover sensor in the restraints control module (RCM).

The Safety Canopy® system, in combination with safety belts, can help reduce the risk of severe injuries in the event of a significant side impact collision or rollover event.

Children 12 years old and under should always be properly restrained in the second row seats. The Safety Canopy® will not interfere with children restrained using a properly installed child or booster seat because it is designed to inflate downward from the headliner above the doors along the side window opening.

The Safety Canopy® system is designed to active when the vehicle sustains lateral deceleration sufficient to cause the RCM to initiate Safety Canopy® inflation or when a certain likelihood of a rollover event is detected by the rollover sensor.

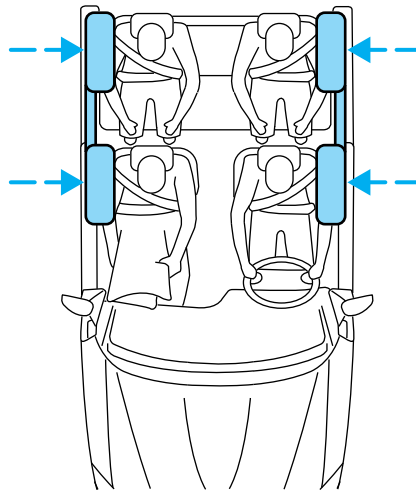



Seating and Safety Restraints

The Safety Canopy® is mounted to roof side-rail sheet metal, behind the headliner, above each row of seats. The Safety Canopy® is designed to inflate between the side window area and occupants to further enhance protection provided in side impact collisions and rollover events.

The fact that the Safety Canopy® did not activate in a collision does not mean that something is wrong with the system. Rather, it means the forces were not of the type sufficient to cause activation. The Safety Canopy® is designed to inflate in certain side impact collisions or rollover events, not in rear impact, frontal or near-frontal collisions, unless the collision causes sufficient lateral deceleration or rollover likelihood.

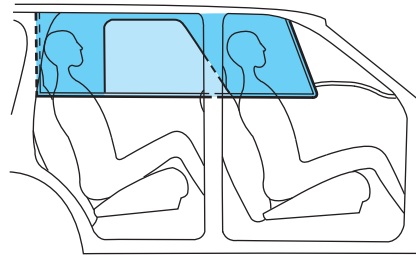
 **WARNING:** Several Safety Canopy® system components get hot after inflation. Do not touch them after inflation.



 **WARNING:** If the Safety Canopy® system has deployed, the Safety Canopy® will not function again unless replaced. The Safety Canopy® system (including the A, B, C, and D pillar trim and headliner) must be inspected and serviced by an authorized dealer. If the Safety Canopy® is not replaced, it will not function again, which will increase the risk of injury in a future collision.

Determining if the system is operational

The SRS uses a readiness light in the instrument cluster or a tone to indicate the condition of the system. Refer to the *Airbag readiness* section in the *Instrument Cluster* chapter. Routine maintenance of the side airbag is not required.

A difficulty with the system is indicated by one or more of the following:

- The readiness light (same light as for front airbag system) will either flash or stay lit.
- The readiness light will not illuminate immediately after ignition is turned on.
- A series of five beeps will be heard. The tone pattern will repeat periodically until the problem and/or light are repaired.

Seating and Safety Restraints

If any of these things happen, even intermittently, have the SRS serviced at your authorized dealer immediately. Unless serviced, the system may not function properly in the event of a collision.

S.O.S. Post Crash Alert

The S.O.S Post Crash Alert automatically flashes the turn signal lamps and sounds the horn three times at four second intervals in the event of a serious impact that deploys an airbag (front, side, side curtain or Safety Canopy®) or the safety belt pretensioners.

The S.O.S. Post Crash Alert can be turned off when any one of the following actions are taken by the driver or any other person:

- pressing the hazard control button,
- or pressing the panic button on the remote entry transmitter.

The feature will continue to operate until the vehicle runs out of power.

Disposal of airbags and airbag equipped vehicles (including pretensioners)

Contact your authorized dealer as soon as possible. Airbags MUST BE disposed of by qualified personnel.

SAFETY RESTRAINTS FOR CHILDREN

See the following sections for directions on how to properly use safety restraints for children. Also see *Airbag supplemental restraint system (SRS)* in this chapter for special instructions about using airbags.

Important child restraint precautions



WARNING: Always make sure your child is secured properly in a device that is appropriate for their height, age and weight. Child safety restraints must be purchased separately from the vehicle. Failure to follow these instructions and guidelines may result in an increased risk of serious injury or death to your child.



WARNING: All children are shaped differently. The Recommendations for Safety Restraints are based on probable child height, age and weight thresholds from NHTSA and other safety organizations or are the minimum requirements of law. Ford recommends checking with a NHTSA Certified Child Passenger Safety Technician (CPST) and your pediatrician to make sure your child seat is appropriate for your child, and is compatible with and properly installed in the vehicle. To locate a child seat fitting station and CPST contact the NHTSA toll free at 1-888-327-4236 or on the internet at <http://www.nhtsa.dot.gov>. Failure to properly restrain children in safety seats made especially for their height, age, and weight may result in an increased risk of serious injury or death to your child.

Seating and Safety Restraints

Recommendations for Safety Restraints for Children		
	Child size, height, weight, or age	Recommended restraint type
Infants or toddlers	Children weighing 40 lb (18 kg) or less (generally age four or younger)	Use a child safety seat (sometimes called an infant carrier, convertible seat, or toddler seat).
Small children	Children who have outgrown or no longer properly fit in a child safety seat (generally children who are less than 4 feet 9 inches (1.45 meters) tall, are greater than age four (4) and less than age twelve (12), and between 40 lbs (18 kg) and 80 lbs (36 kg) and upward to 100 lbs (45 kg) if recommended by your child restraint manufacturer)	Use a belt-positioning booster seat.
Larger children	Children who have outgrown or no longer properly fit in a belt-positioning booster seat (generally children who are at least 4 feet 9 inches (1.45 meters) tall or greater than 80 lb (36 kg) or 100 lb (45 kg) if recommended by child restraint manufacturer)	Use a vehicle safety belt having the lap belt snug and low across the hips, shoulder belt centered across the shoulder and chest, and seatback upright.

- You are required by law to properly use safety seats for infants and toddlers in the U.S. and Canada.
- Many states and provinces require that small children use approved booster seats until they reach age eight, a height of 4 ft 9 in (1.45 meters) tall, or 80 lb (36 kg). Check your local and state or provincial laws for specific requirements regarding the safety of children in your vehicle.
- When possible, always properly restrain children twelve (12) years of age and under in a rear seating position of your vehicle. Accident statistics suggest that children are safer when properly restrained in the rear seating positions than in a front seating position.

Seating and Safety Restraints

Recommendations for attaching child safety restraints for children

Restraint Type	Child Weight	Use any attachment method as indicated below by "X"				
		LATCH (lower anchors and top tether anchor)	LATCH (lower anchors only)	Safety belt and top tether anchor	Safety belt and LATCH (lower anchors and top tether anchor)	Safety belt only
Rear facing child seat	Up to 48 lb (21 kg)		X			X
Forward facing child seat	Up to 48 lb (21 kg)	X		X	X	
Forward facing child seat	Over 48 lb (21 kg)			X	X	

 **WARNING:** Air bags can kill or injure a child in a child seat. NEVER place a rear-facing child seat in front of an active air bag. If you must use a forward-facing child seat in the front seat, move the vehicle seat all the way back. When possible, all children age 12 and under should be properly restrained in a rear seating position. If all children cannot be seated and restrained properly in a rear seating position, properly restrain the largest child in the front seat.

 **WARNING:** Always carefully follow the instructions and warnings provided by the manufacturer of any child restraint to determine if the restraint device is appropriate for your child's size, height, weight, or age. Follow the child restraint manufacturer's instructions and warnings provided for installation and use in conjunction with the instructions and warnings provided by the vehicle manufacturer. A safety seat that is improperly installed or utilized, is inappropriate for your child's height, age, or weight or does not properly fit the child may increase the risk of serious injury or death.

Seating and Safety Restraints



WARNING: Never let a passenger hold a child on his or her lap while the vehicle is moving. The passenger cannot protect the child from injury in a collision, which may result in serious injury or death.



WARNING: Never use pillows, books, or towels to boost a child. They can slide around and increase the likelihood of injury or death in a collision.



WARNING: Always restrain an unoccupied child seat or booster seat. These objects may become projectiles in a collision or sudden stop, which may increase the risk of serious injury.



WARNING: Never place, or allow a child to place, the shoulder belt under a child's arm or behind the back because it reduces the protection for the upper part of the body and may increase the risk of injury or death in a collision.



WARNING: Do not leave children, unreliable adults, or pets unattended in your vehicle.

Transporting children

Always make sure your child is secured properly in a device that is appropriate for their age, height and weight. All children are shaped differently. The child height, age and weight thresholds provided are recommendations or the minimum requirements of law. The National Highway Traffic Safety Administration (NHTSA) provides education and training to ensure that all children ages 0 to 16 are properly restrained in the correct restraint system. Ford recommends checking with a NHTSA Certified Child Passenger Safety Technician (CPST) and your pediatrician to make sure your seat is appropriate for your child and properly installed in the vehicle. To locate a child seat fitting station and CPST contact the NHTSA toll free at **1-888-327-4236** or on the internet at <http://www.nhtsa.dot.gov>.

Follow all the safety restraint and airbag precautions that apply to adult passengers in your vehicle.

Seating and Safety Restraints

If the child is the proper height, age, and weight (as specified by your child safety seat or booster manufacturer), fits the restraint and can be restrained properly, then restrain the child in the child safety seat or with the belt-positioning booster. Remember that child seats and belt-positioning boosters vary and may be designed to fit children of different heights, ages and weights. Children who are too large for child safety seats or belt-positioning boosters (as specified by your child safety seat manufacturer) should always properly wear safety belts.

SAFETY SEATS FOR CHILDREN

Infant and/or toddler seats

Use a safety seat that is recommended for the size and weight of the child.

When installing a child safety seat:

- Review and follow the information presented in the *Airbag supplemental restraint system (SRS)* section in this chapter.
- Carefully follow all of the manufacturer's instructions included with the safety seat you put in your vehicle. If you do not install and use the safety seat properly, the child may be injured in a sudden stop or collision.

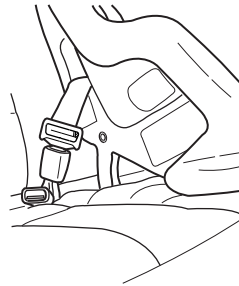

Airbags can kill or injure a child in a child seat. NEVER place a rear-facing child seat in front of an active airbag. If you must use a forward-facing child seat in the front seat, move the vehicle seat all the way back.

Children 12 and under should be properly restrained in a rear seating position whenever possible. If all children cannot be seated and restrained properly in a rear seating position, properly restrain the largest child in the front seat.

Seating and Safety Restraints

Installing child safety seats with combination lap and shoulder belts

Check to make sure the child seat is properly secured before each use. Children 12 and under should be properly restrained in a rear seating position whenever possible. If all children cannot be seated and restrained properly in a rear seating position, properly restrain the largest child in the front seat.

When installing a child safety seat with combination lap/shoulder belts:

- Use the correct safety belt buckle for that seating position.
- Insert the belt tongue into the proper buckle until you hear a snap and feel it latch. Make sure the tongue is securely fastened in the buckle.
- Keep the buckle release button pointing up and away from the safety seat, with the tongue between the child seat and the release button, to help prevent accidental unbuckling.
- Place vehicle seat back in upright position.
- Put the safety belt in the automatic locking mode. Refer to step 5 below.



WARNING: Depending on where you secure a child restraint, and depending on the child restraint design, you may block access to certain safety belt buckle assemblies and/or LATCH lower anchors, rendering those features potentially unusable. To avoid risk of injury, occupants should only use seating positions where they are able to be properly restrained.

Seating and Safety Restraints

If you are using a Regular Cab center seat, see *Installing child safety seats in cinch tongue combination lap and shoulder belt seating position* later in this chapter for instructions.

Perform the following steps when installing the child seat with combination lap/shoulder belts:

Note: Although the child seat illustrated is a forward facing child seat, the steps are the same for installing a rear facing child seat.

1. Position the child safety seat in a seat with a combination lap and shoulder belt.

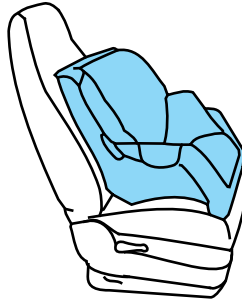

2. Pull down on the shoulder belt and then grasp the shoulder belt and lap belt together.

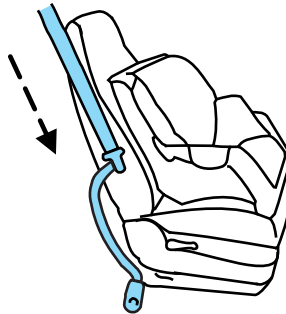

Seating and Safety Restraints

3. While holding the shoulder and lap belt portions together, route the tongue through the child seat according to the child seat manufacturer's instructions. Be sure the belt webbing is not twisted.

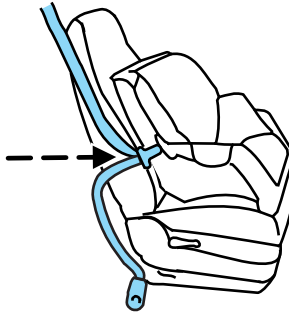

4. Insert the belt tongue into the proper buckle (the buckle closest to the direction the tongue is coming from) for that seating position until you hear a snap and feel the latch engage. Make sure the tongue is latched securely by pulling on it.

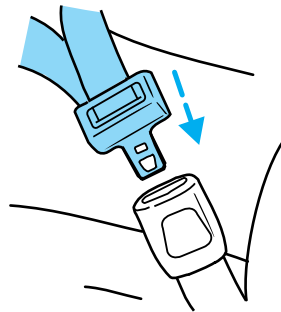

5. To put the retractor in the automatic locking mode, grasp the shoulder portion of the belt and pull downward until all of the belt is pulled out and a click is heard.

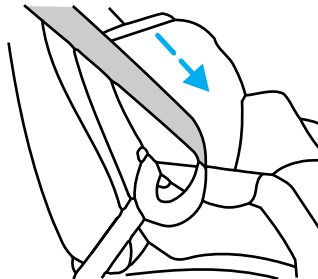

6. Allow the belt to retract to remove slack. The belt will click as it retracts to indicate it is in the automatic locking mode.

7. Try to pull the belt out of the retractor to make sure the retractor is in the automatic locking mode (you should not be able to pull more belt out). If the retractor is not locked, unbuckle the belt and repeat Steps 5 and 6.

Seating and Safety Restraints

8. Remove remaining slack from the belt. Force the seat down with extra weight, e.g., by pressing down or kneeling on the child restraint while pulling up on the shoulder belt in order to force slack from the belt. This is necessary to remove the remaining slack that will exist once the additional weight of the child is added to the child restraint. It also helps to achieve the proper snugness of the child seat to the vehicle. Sometimes, a slight lean towards the buckle will additionally help to remove remaining slack from the belt.

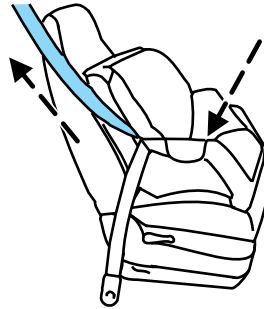

9. Attach the tether strap (if the child seat is equipped). Refer to *Attaching child safety seats with tether straps* later in this chapter.

10. Before placing the child in the seat, forcibly move the seat forward and back to make sure the seat is securely held in place. To check this, grab the seat at the belt path and attempt to move it side to side and forward and back. There should be no more than one inch (2.5 cm) of movement for proper installation.

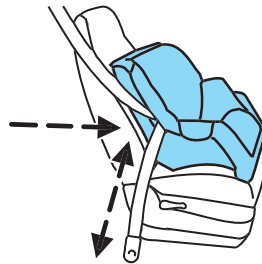

11. Ford recommends checking with a NHTSA Certified Child Passenger Safety Technician (CPST) to make certain the child restraint is properly installed.

Installing child safety seats in cinch tongue combination lap and shoulder belt seating position (Front center seating position only)

If you are using a regular cab center seat, see *Center front safety belt (Regular Cab center seating position only)* under *Combination lap and shoulder belts* earlier in this chapter for instructions on attaching the mini-buckle.

The belt webbing below the tongue is the lap portion of the combination lap/shoulder belt, and the belt webbing above the tongue is the shoulder belt portion of the combination lap/shoulder belt.

Seating and Safety Restraints



WARNING: Always use both lap and shoulder safety belt in the Regular Cab center seating position.

1. Position the child safety seat in the Regular Cab center front seat.

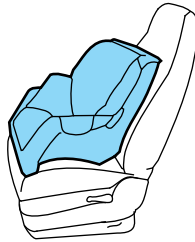

2. If the center lap/shoulder safety belt has been disconnected from the seat to carry large cargo behind the seat, reconnect it by buckling the small buckle on the end of the belt into the mini-buckle on the driver's side.

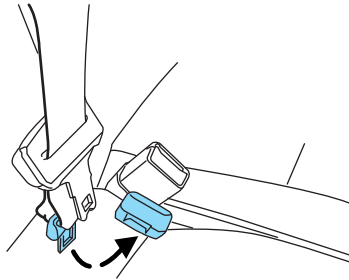

WARNING: Airbags can kill or injure a child in a child seat. If you must use a forward-facing child seat in the front seat, move seat all the way back.



WARNING: Rear facing child seats should NEVER be placed in front of an active airbag.

Seating and Safety Restraints

3. Slide the tongue up the webbing.

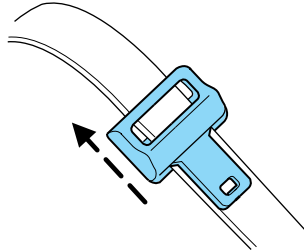

4. While holding both shoulder and lap portions next to the tongue, route the tongue and webbing through the child seat according to the child seat manufacturer's instructions. Be sure that the belt webbing is not twisted.

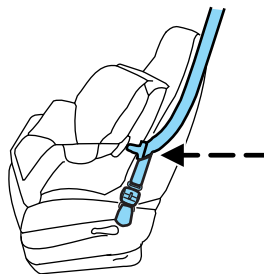

5. Insert the belt tongue into the proper buckle (the buckle closest to the direction the tongue is coming from) for that seating position until you hear a snap and feel the latch engage. Make sure the tongue is latched securely by pulling on it.

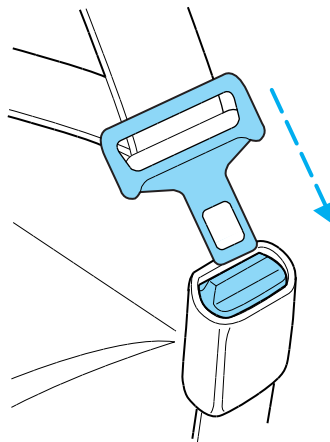

Seating and Safety Restraints

6. While pushing down with your knee on the child seat pull up on the shoulder belt portion to tighten the lap belt portion of the combination lap and shoulder belt.

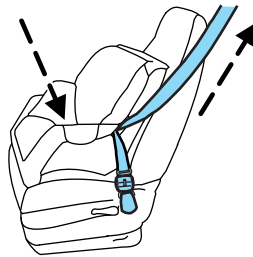

7. Allow the safety belt to retract and remove any slack in the belt to securely tighten the child safety seat in the vehicle.

8. Attach the tether strap (if the child seat is equipped). Refer to *Attaching child safety seats with tether straps* later in this chapter.

9. Before placing the child into the child seat, forcibly pull the child seat forward and back to make sure that the seat is held securely in place. To check this, grab the seat at the belt path and attempt to move it side to side and forward and back. There should be no more than one inch (2.5 cm) of movement for proper installation.

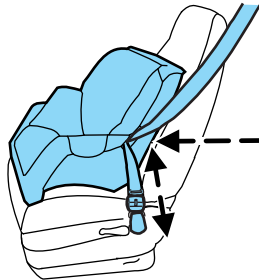

10. Check from time to time to be sure that there is no slack in the lap/shoulder belt. The shoulder belt must be snug to keep the lap belt tight during a collision.

11. Ford recommends checking with a NHTSA Certified Child Passenger Safety Technician (CPST) to make certain the child restraint is properly installed.

Installing child safety seats in the front row lap belt seating positions (SuperCab and CrewCab)



WARNING: Installing a child safety seat in the front row lap seating position should be avoided if at all possible. The passenger sensing system does not recognize child seats in the front center seating position.

Seating and Safety Restraints



WARNING: Never place a rear-facing child seat in the front center seating position of a vehicle with rear seating positions.

1. Lengthen the lap belt. To lengthen the belt, hold the tongue so that its bottom is perpendicular to the direction of webbing while sliding the tongue up the webbing.
2. Place the child safety seat in the center seating position.
3. Route the tongue and webbing through the child seat according to the child seat manufacturer's instructions.
4. Insert the belt tongue into the proper buckle for the center seating position until you hear a snap and feel it latch. Make sure the tongue is securely fastened to the buckle by pulling on the tongue.
5. Push down on the child seat while pulling on the loose end of the lap belt webbing to tighten the belt.
6. Before placing the child into the child seat, forcibly tilt the child seat from side to side and in forward direction to make sure that the seat is securely held in place. To check this, grab the seat at the belt path and attempt to move it side to side and forward and back. There should be no more than one inch (2.5 cm) of movement for proper installation.
7. Ford recommends checking with a NHTSA Certified Child Passenger Safety Technician (CPST) to make certain the child restraint is properly installed.

Attaching child safety seats with LATCH (Lower Anchors and Tethers for Children) attachments

The LATCH system is composed of three vehicle anchor points: two (2) lower anchors located where the vehicle seat back and seat cushion meet (called the "seat bight") and one (1) top tether anchor located behind that seating position.

LATCH compatible child safety seats have two rigid or webbing mounted attachments that connect to the two lower anchors at the LATCH equipped seating positions in your vehicle. This type of attachment method eliminates the need to use safety belts to attach the child seat, however the safety belt can still be used to attach the child seat if the lower anchors are not used. For forward-facing child seats, the top tether strap must also be attached to the proper top tether anchor, if a top tether strap has been provided with your child seat. See *Attaching child safety seats with tether straps* in this chapter for more information.

Seating and Safety Restraints

Your vehicle is equipped with LATCH lower anchors for child seat installation at the following seating positions (LATCH is not available on F150 Regular cab) :

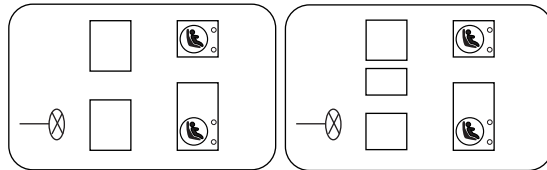

- F150 SuperCab and CrewCab

The LATCH anchors are located at the rear section of the rear seat between the cushion and seatback. Follow the child seat manufacturer's instructions to properly install a child seat with LATCH attachments.

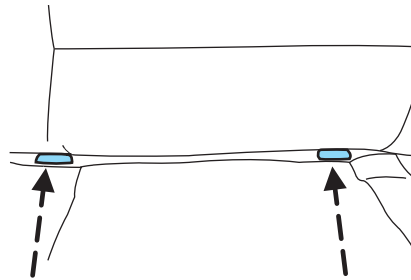

Follow the instructions later in this chapter on attaching child safety seats with tether straps.

Attach LATCH lower attachments of the child seat only to the anchors shown.

WARNING: Never attach two child safety seats to the same anchor. In a crash, one anchor may not be strong enough to hold two child safety seat attachments and may break, causing serious injury or death.

WARNING: Depending on where you secure a child restraint, and depending on the child restraint design, you may block access to certain safety belt buckle assemblies and/or LATCH lower anchors, rendering those features potentially unusable. To avoid risk of injury, occupants should only use seating positions where they are able to be properly restrained.

Seating and Safety Restraints

Use of inboard lower anchors from the outboard seating positions (center seating use)

The lower anchors at the center of the second row rear seat are spaced 652 mm (25.7 inches) apart. The standardized spacing for LATCH lower anchors is 280 mm (11 inches) center to center. A child seat with rigid LATCH attachments cannot be installed at the center seating position. LATCH compatible child seats (with attachments on belt webbing) can only be used at this seating position provided that the child seat manufacturer's instructions permit use with the anchor spacing stated. Do not attach a child seat to any lower anchor if an adjacent child seat is attached to that anchor.



WARNING: The standardized spacing for LATCH lower anchors is 280 mm (11 inches) center to center. Do not use LATCH lower anchors for the center seating position unless the child seat manufacturer's instructions permit and specify using anchors spaced at least as far apart as those in this vehicle.

If you install a child seat with rigid LATCH attachments, do not tighten the tether strap enough to lift the child seat off the vehicle seat cushion when the child is seated in it. Keep the tether strap just snug without lifting the front of the child seat. Keeping the child seat just touching the vehicle seat gives the best protection in a severe crash.

Each time you use the safety seat, check that the seat is properly attached to the lower anchors and tether anchor, if applicable. Tug the child seat from side to side and forward and back where it is secured to the vehicle. The seat should move less than one inch when you do this for a proper installation.

If the safety seat is not anchored properly, the risk of a child being injured in a crash greatly increases.

Combining safety belt and LATCH lower anchors for attaching child safety seats

When used in combination, either the safety belt or the LATCH lower anchors may be attached first, provided a proper installation is achieved. Attach the tether strap afterward, if included with the child seat. Refer to *Recommendations for attaching child safety restraints for children* in this chapter.

Attaching child safety seats with tether straps

Many forward-facing child safety seats include a tether strap which extends from the back of the child safety seat and hooks to an anchoring

Seating and Safety Restraints

point called the top tether anchor. Tether straps are available as an accessory for many older safety seats. Contact the manufacturer of your child seat for information about ordering a tether strap, or to obtain a longer tether strap if the tether strap on your safety seat does not reach the appropriate top tether anchor in the vehicle.

The passenger seats of your vehicle are equipped with built-in tether strap anchors located behind the seats as described below.

The tether anchors in your vehicle may be loops of webbing above the seatback or an anchor bracket behind the seat on the rear edge of the seat cushion.

The rear seat in the SuperCab and SuperCrew has three straps along the top of the seatback that function as both routing loops for the tether straps and anchor loops.

The tether strap anchors in your vehicle are in the following positions (shown from top view):

- **F150 Regular Cab**

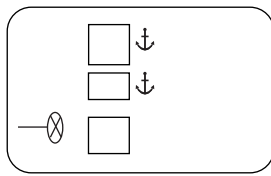

- **F150 CrewCab and SuperCab**

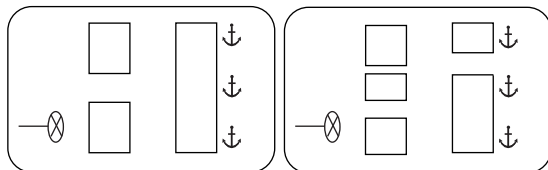

Attach the tether strap only to the appropriate tether anchor as shown. The tether strap may not work properly if attached somewhere other than the correct tether anchor.

Once the child safety seat has been installed using either the safety belt, the lower anchors of the LATCH system, or both, you can attach the top tether strap.

Seating and Safety Restraints

Front seat tether strap attachment

1. Route the child safety seat tether strap over the back of the seat and under the head restraint.

For vehicles with adjustable head restraints, route the tether strap under the head restraint and between the head restraint posts, otherwise route the tether strap over the top of the seatback.

2. Locate the correct anchor for the selected seating position.

- You may need to pull the seatback forward to access the tether anchors. Make sure the seatback is locked in the upright position before installing the child seat.

3. Clip the tether strap to the anchor as shown.

- Regular Cab passenger and center seats (located on back panel)

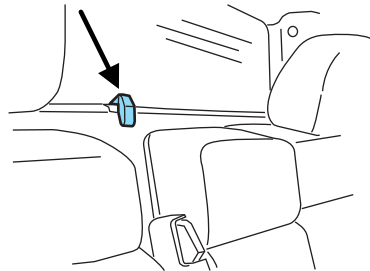

If the tether strap is clipped incorrectly, the child safety seat may not be retained properly in the event of a collision.

4. Tighten the child safety seat tether strap according to the manufacturer's instructions.

If the safety seat is not anchored properly, the risk of a child being injured in a collision greatly increases.

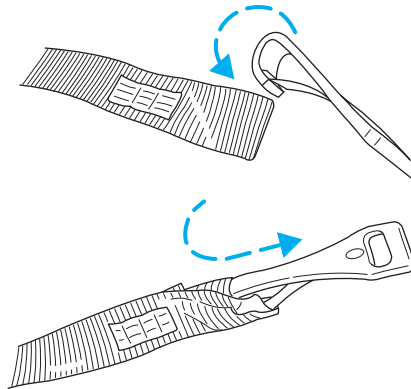

Seating and Safety Restraints

Rear seat tether strap attachment

There are three loops of webbing just above the back of the rear seat (along the bottom edge of the rear window) in the SuperCab and SuperCrew. These loops are to be used as both routing loops and anchor loops for up to three child safety seat tether straps. For example, the center loop can be used as a routing loop for a child safety seat in the center rear seat and as an anchoring loop for child seats installed in the outboard rear seats.

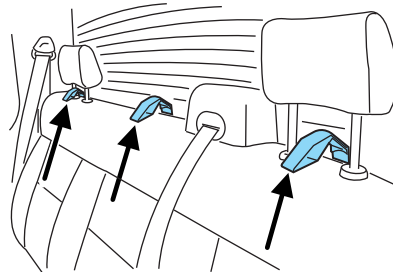

Many tether straps cannot be tightened if the tether strap is hooked to the loop directly behind the child seat. To provide a tight tether strap:

1. Route the tether strap under the head restraint and through the loop directly behind the child seat.



2. Route the tether strap behind the head restraint supports to a loop behind an adjacent seating position, and hook the strap hook onto the loop. If using the driver's side, pass the strap behind the shoulder belt mounting for the center seat.

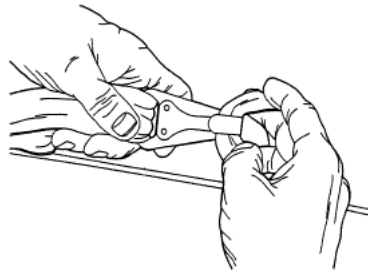

- Always put the tether strap through the routing loop. The head restraint support post will hold the child seat tightly, but the head restraint post is not strong enough to hold the child seat during a collision.

Seating and Safety Restraints

3. Tighten the tether strap according to the child seat manufacturer's instructions.

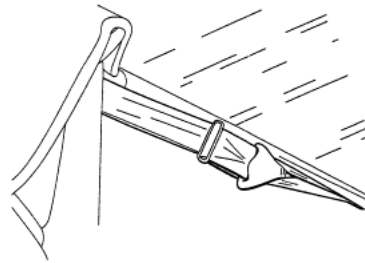

If the safety seat is not anchored properly, the risk of a child being injured in a collision greatly increases.

Child booster seats

The belt-positioning booster (booster seat) is used to improve the fit of the vehicle safety belt. Children outgrow a typical child seat (e.g., convertible or toddler seat) when they weigh about 40 lb (18 kg) and are around four (4) years of age. Consult your child safety seat owner guide for the weight, height, and age limits specific to your child safety seat. Keep your child in the child safety seat if it properly fits the child, remains appropriate for their weight, height and age AND if properly secured to the vehicle.

Although the lap/shoulder belt will provide some protection, children who have outgrown a typical child seat are still too small for lap/shoulder belts to fit properly, and wearing an improperly fitted vehicle safety belt could increase the risk of serious injury in a crash. To improve the fit of both the lap and shoulder belt on children who have outgrown child safety seats, Ford Motor Company recommends use of a belt-positioning booster.

Booster seats position a child so that vehicle lap/shoulder safety belts fit better. They lift the child up so that the lap belt rests low across the hips and the knees bend comfortably at the edge of the cushion, while minimizing slouching. Booster seats may also make the shoulder belt fit better and more comfortably. Try to keep the belt near the middle of the shoulder and across the center of the chest. Moving the child closer (a few centimeters or inches) to the center of the vehicle, but remaining in the same seating position, may help provide a good shoulder belt fit.

Seating and Safety Restraints

When children should use booster seats

Children need to use booster seats from the time they outgrow the toddler seat until they are big enough for the vehicle seat and lap/shoulder belt to fit properly. Generally this is when they reach a height of at least 4 feet 9 inches (1.45 meters) tall (around age eight to age twelve and between 40 lb (18 kg) and 80 lb (36 kg) or upward to 100 lb (45 kg) if recommended by your child restraint manufacturer). Many state and provincial laws require that children use approved booster seats until they reach age eight, a height of 4 feet 9 inches (1.45 meters) tall, or 80 lb (36 kg).

Booster seats should be used until you can answer YES to ALL of these questions when seated without a booster seat:

- Can the child sit all the way back against the vehicle seat back with knees bent comfortably at the edge of the seat cushion?
- Can the child sit without slouching?

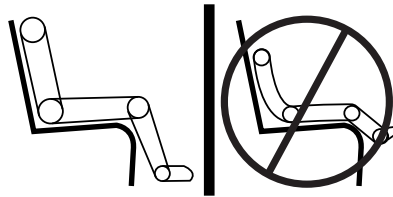

- Does the lap belt rest low across the hips?
- Is the shoulder belt centered on the shoulder and chest?
- Can the child stay seated like this for the whole trip?

Seating and Safety Restraints

Types of booster seats

There are generally two types of belt-positioning booster seats: backless and high back. Always use booster seats in conjunction with the vehicle lap/shoulder belt.

- **Backless booster seats**

If your backless booster seat has a removable shield, remove the shield. If a vehicle seating position has a low seat back or no head restraint, a backless booster seat may place your child's head (as measured at the tops of the ears) above the top of the seat. In this case, move the backless booster to another seating position with a higher seat back or head restraint and lap/shoulder belts, or consider using a high back booster seat.

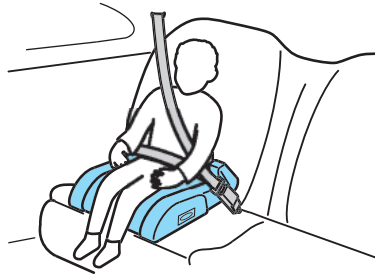

- **High back booster seats**

If, with a backless booster seat, you cannot find a seating position that adequately supports your child's head, a high back booster seat would be a better choice.



Seating and Safety Restraints

Children and booster seats vary in size and shape. Choose a booster that keeps the lap belt low and snug across the hips, never up across the stomach, and lets you adjust the shoulder belt to cross the chest and rest snugly near the center of the shoulder. The drawings below compare the ideal fit (center) to a shoulder belt uncomfortably close to the neck and a shoulder belt that could slip off the shoulder. The drawings below also show how the lap belt should be low and snug across the child's hips.

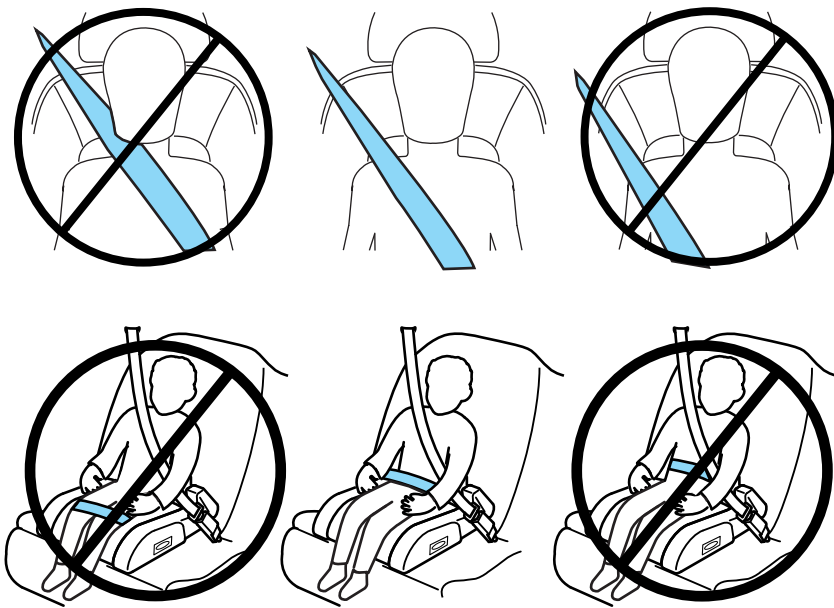

If the booster seat slides on the vehicle seat, placing a rubberized mesh sold as shelf or carpet liner under the booster seat may improve this condition. Do not introduce any item thicker than this under the booster seat. Check with the booster seat manufacturer's instructions.

The importance of shoulder belts

Using a booster without a shoulder belt increases the risk of a child's head hitting a hard surface in a collision. For this reason, you should never use a booster seat with a lap belt only. It is generally best to use a booster seat with lap/shoulder belts in the back seat.

Seating and Safety Restraints

Move a child to a different seating location if the shoulder belt does not stay positioned on the shoulder during use.

Follow all instructions provided by the manufacturer of the booster seat.



WARNING: Never place, or allow a child to place, the shoulder belt under a child's arm or behind the back because it reduces the protection for the upper part of the body and may increase the risk of injury or death in a collision.

Child restraint and safety belt maintenance

Inspect the vehicle safety belts and child safety seat systems periodically to make sure they work properly and are not damaged. Inspect the vehicle and child seat safety belts to make sure there are no nicks, tears or cuts. Replace if necessary. All vehicle safety belt assemblies, including retractors, buckles, front safety belt buckle assemblies, buckle support assemblies (slide bar-if equipped), shoulder belt height adjusters (if equipped), shoulder belt guide on seatback (if equipped), child safety seat LATCH and tether anchors, and attaching hardware, should be inspected after a collision. Refer to the child restraint manufacturer's instructions for additional inspection and maintenance information specific to the child restraint. Ford Motor Company recommends that all safety belt assemblies in use in vehicles involved in a collision be replaced. However, if the collision was minor and an authorized dealer finds that the belts do not show damage and continue to operate properly, they do not need to be replaced. Safety belt assemblies not in use during a collision should also be inspected and replaced if either damage or improper operation is noted.

For proper care of soiled safety belts, refer to *Interior* in the *Cleaning* chapter.



WARNING: Failure to inspect and if necessary replace the safety belt assembly or child restraint system under the above conditions could result in severe personal injuries in the event of a collision.

Tires, Wheels and Loading

NOTICE TO UTILITY VEHICLE AND TRUCK OWNERS

Utility vehicles and trucks handle differently than passenger cars in the various driving conditions that are encountered on streets, highways and off-road. Utility vehicles and trucks are not designed for cornering at speeds as high as passenger cars any more than low-slung sports cars are designed to perform satisfactorily under off-road conditions.

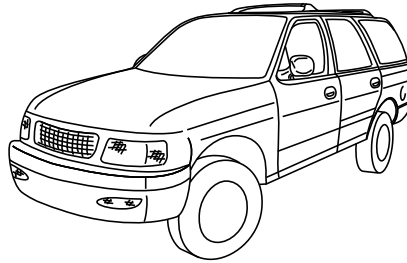

! **WARNING:** Utility vehicles have a significantly higher rollover rate than other types of vehicles. To reduce the risk of serious injury or death from a rollover or other crash you must:

- Avoid sharp turns and abrupt maneuvers;
- Drive at safe speeds for the conditions;
- Keep tires properly inflated;
- Never overload or improperly load your vehicle; and
- Make sure every passenger is properly restrained.

! **WARNING:** In a rollover crash, an unbelted person is significantly more likely to die than a person wearing a seat belt. All occupants must wear seat belts and children/infants must use appropriate restraints to minimize the risk of injury or ejection.

Study your *Owner's Guide* and any supplements for specific information about equipment features, instructions for safe driving and additional precautions to reduce the risk of an accident or serious injury.

VEHICLE CHARACTERISTICS

4WD and AWD Systems (if equipped)

A vehicle equipped with AWD or 4WD (when selected) has the ability to use all four wheels to power itself. This increases traction which may enable you to safely drive over terrain and road conditions that a conventional two-wheel drive vehicle cannot.

Tires, Wheels and Loading

Power is supplied to all four wheels through a transfer case or power transfer unit. 4WD vehicles allow you to select different drive modes as necessary. Information on transfer case operation and shifting procedures can be found in the *Driving* chapter. Information on transfer case maintenance can be found in the *Maintenance and Specifications* chapter. You should become thoroughly familiar with this information before you operate your vehicle.

On some 4WD models, the initial shift from two-wheel drive to 4WD while the vehicle is moving can cause a momentary clunk and ratcheting sound. These sounds are normal as the front drivetrain comes up to speed and is not cause for concern.



WARNING: Do not become overconfident in the ability of 4WD and AWD vehicles. Although a 4WD or AWD vehicle may accelerate better than two-wheel drive vehicle in low traction situations, it won't stop any faster than two-wheel drive vehicles. Always drive at a safe speed.

How your vehicle differs from other vehicles

SUV and trucks can differ from some other vehicles in a few noticeable ways. Your vehicle may be:

- Higher – to allow higher load carrying capacity and to allow it to travel over rough terrain without getting hung up or damaging underbody components.
- Shorter – to give it the capability to approach inclines and drive over the crest of a hill without getting hung up or damaging underbody components. All other things held equal, a shorter wheelbase may make your vehicle quicker to respond to steering inputs than a vehicle with a longer wheelbase.

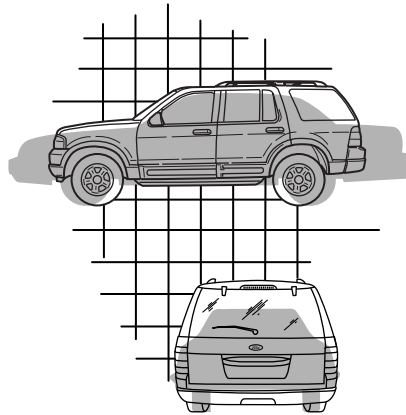

Tires, Wheels and Loading

- Narrower — to provide greater maneuverability in tight spaces, particularly in off-road use.

As a result of the above dimensional differences, SUV's and trucks often will have a higher center of gravity and a greater difference in center of gravity between the loaded and unloaded condition.

These differences that make your vehicle so versatile also make it handle differently than an ordinary passenger car.

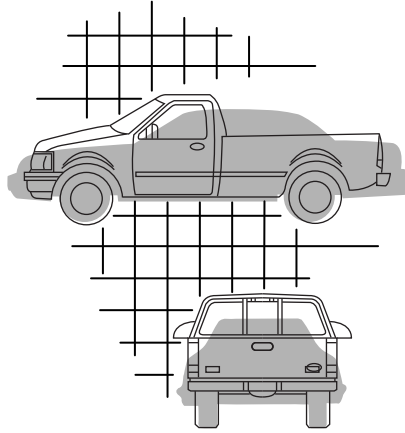

INFORMATION ABOUT UNIFORM TIRE QUALITY GRADING

Tire Quality Grades apply to new pneumatic passenger car tires. The Quality grades can be found where applicable on the tire sidewall between tread shoulder and maximum section width. For example:

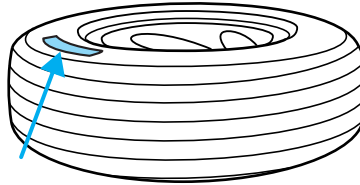

- **Treadwear 200 Traction AA Temperature A**

These Tire Quality Grades are determined by standards that the United States Department of Transportation has set.

Tire Quality Grades apply to new pneumatic passenger car tires. They do not apply to deep tread, winter-type snow tires, space-saver or temporary use spare tires, light truck or "LT" type tires, tires with nominal rim diameters of 10 to 12 inches or limited production tires as defined in Title 49 Code of Federal Regulations Part 575.104(c)(2).

U.S. Department of Transportation-Tire quality grades: The U.S. Department of Transportation requires Ford Motor Company to give you the following information about tire grades exactly as the government has written it.

Tires, Wheels and Loading

Treadwear

The treadwear grade is a comparative rating based on the wear rate of the tire when tested under controlled conditions on a specified government test course. For example, a tire graded 150 would wear one and one-half (1½) times as well on the government course as a tire graded 100. The relative performance of tires depends upon the actual conditions of their use, however, and may depart significantly from the norm due to variations in driving habits, service practices, and differences in road characteristics and climate.

Traction AA A B C

The traction grades, from highest to lowest are AA, A, B, and C. The grades represent the tire's ability to stop on wet pavement as measured under controlled conditions on specified government test surfaces of asphalt and concrete. A tire marked C may have poor traction performance.



WARNING: The traction grade assigned to this tire is based on straight-ahead braking traction tests, and does not include acceleration, cornering, hydroplaning or peak traction characteristics.

Temperature A B C

The temperature grades are A (the highest), B and C, representing the tire's resistance to the generation of heat and its ability to dissipate heat when tested under controlled conditions on a specified indoor laboratory test wheel. Sustained high temperature can cause the material of the tire to degenerate and reduce tire life, and excessive temperature can lead to sudden tire failure. The grade C corresponds to a level of performance which all passenger car tires must meet under the Federal Motor Vehicle Safety Standard No. 139. Grades B and A represent higher levels of performance on the laboratory test wheel than the minimum required by law.



WARNING: The temperature grade for this tire is established for a tire that is properly inflated and not overloaded. Excessive speed, underinflation, or excessive loading, either separately or in combination, can cause heat buildup and possible tire failure.

TIRES

Tires are designed to give many thousands of miles of service, but they must be maintained in order to get the maximum benefit from them.

Tires, Wheels and Loading

Glossary of tire terminology

- **Tire label:** A label showing the OE (Original Equipment) tire sizes, recommended inflation pressure and the maximum weight the vehicle can carry.
- **Tire Identification Number (TIN):** A number on the sidewall of each tire providing information about the tire brand and manufacturing plant, tire size and date of manufacture. Also referred to as DOT code.
- **Inflation pressure:** A measure of the amount of air in a tire.
- **Standard load:** A class of P-metric or Metric tires designed to carry a maximum load at 35 psi [37 psi (2.5 bar) for Metric tires]. Increasing the inflation pressure beyond this pressure will not increase the tire's load carrying capability.
- **Extra load:** A class of P-metric or Metric tires designed to carry a heavier maximum load at 41 psi [43 psi (2.9 bar) for Metric tires]. Increasing the inflation pressure beyond this pressure will not increase the tire's load carrying capability.
- **kPa:** Kilopascal, a metric unit of air pressure.
- **PSI:** Pounds per square inch, a standard unit of air pressure.
- **Cold inflation pressure:** The tire pressure when the vehicle has been stationary and out of direct sunlight for an hour or more and prior to the vehicle being driven for 1 mile (1.6 km).
- **Recommended inflation pressure:** The cold inflation pressure found on the Safety Compliance Certification Label or Tire Label located on the B-Pillar or the edge of the driver's door.
- **B-pillar:** The structural member at the side of the vehicle behind the front door.
- **Bead area of the tire:** Area of the tire next to the rim.
- **Sidewall of the tire:** Area between the bead area and the tread.
- **Tread area of the tire:** Area of the perimeter of the tire that contacts the road when mounted on the vehicle.
- **Rim:** The metal support (wheel) for a tire or a tire and tube assembly upon which the tire beads are seated.

INFLATING YOUR TIRES

Safe operation of your vehicle requires that your tires are properly inflated. Remember that a tire can lose up to half of its air pressure without appearing flat.

Tires, Wheels and Loading

Every day before you drive, check your tires. If one looks lower than the others, use a tire gauge to check pressure of all tires and adjust if required.

At least once a month and before long trips, inspect each tire and check the tire pressure with a tire gauge (including spare, if equipped). Inflate all tires to the inflation pressure recommended by Ford Motor Company.

You are strongly urged to buy a reliable tire pressure gauge, as automatic service station gauges may be inaccurate. Ford recommends the use of a digital or dial-type tire pressure gauge rather than a stick-type tire pressure gauge.

Use the recommended cold inflation pressure for optimum tire performance and wear. Under-inflation or over-inflation may cause uneven treadwear patterns.



WARNING: Under-inflation is the most common cause of tire failures and may result in severe tire cracking, tread separation or "blowout", with unexpected loss of vehicle control and increased risk of injury. Under-inflation increases sidewall flexing and rolling resistance, resulting in heat buildup and internal damage to the tire. It also may result in unnecessary tire stress, irregular wear, loss of vehicle control and accidents. A tire can lose up to half of its air pressure and not appear to be flat!

Always inflate your tires to the Ford recommended inflation pressure even if it is less than the maximum inflation pressure information found on the tire. The Ford recommended tire inflation pressure is found on the Safety Compliance Certification Label or Tire Label which is located on the B-Pillar or the edge of the driver's door. Failure to follow the tire pressure recommendations can cause uneven treadwear patterns and adversely affect the way your vehicle handles.

Maximum Permissible Inflation Pressure is the tire manufacturer's maximum permissible pressure and/or the pressure at which the maximum load can be carried by the tire. This pressure is normally higher than the manufacturer's recommended cold inflation pressure which can be found on the Safety Compliance Certification Label or Tire Label which is located on the B-Pillar or the edge of the driver's door. The cold inflation pressure should never be set lower than the recommended pressure on the Safety Compliance Certification Label or Tire Label.

Tires, Wheels and Loading

When weather temperature changes occur, tire inflation pressures also change. A 10°F (6°C) temperature drop can cause a corresponding drop of 1 psi (7 kPa) in inflation pressure. Check your tire pressures frequently and adjust them to the proper pressure which can be found on the Safety Compliance Certification Label or Tire Label.

To check the pressure in your tire(s):

1. Make sure the tires are cool, meaning they are not hot from driving even a mile.

If you are checking tire pressure when the tire is hot, (i.e. driven more than 1 mile [1.6 km]), never “bleed” or reduce air pressure. The tires are hot from driving and it is normal for pressures to increase above recommended cold pressures. A hot tire at or below recommended cold inflation pressure could be significantly under-inflated.

Note: If you have to drive a distance to get air for your tire(s), check and record the tire pressure first and add the appropriate air pressure when you get to the pump. It is normal for tires to heat up and the air pressure inside to go up as you drive.

2. Remove the cap from the valve on one tire, then firmly press the tire gauge onto the valve and measure the pressure.

3. Add enough air to reach the recommended air pressure.

Note: If you overfill the tire, release air by pushing on the metal stem in the center of the valve. Then recheck the pressure with your tire gauge.

4. Replace the valve cap.

5. Repeat this procedure for each tire, including the spare.

Note: Some spare tires operate at a higher inflation pressure than the other tires. For T-type/mini-spare tires (see the *Dissimilar spare tire/wheel information* section for description): Store and maintain at 60 psi (4.15 bar). For Full Size and Dissimilar spare tires (see the *Dissimilar spare tire/wheel information* section for description): Store and maintain at the higher of the front and rear inflation pressure as shown on the Tire Label.

6. Visually inspect the tires to make sure there are no nails or other objects embedded that could poke a hole in the tire and cause an air leak.

7. Check the sidewalls to make sure there are no gouges, cuts or bulges.

TIRE CARE

Inspecting your tires

Periodically inspect the tire treads for uneven or excessive wear and remove objects such as stones, nails or glass that may be wedged in the

Tires, Wheels and Loading

tread grooves. Check for holes or cuts that may permit air leakage from the tire and make necessary repairs. Also inspect the tire sidewalls for cracking, cuts, bruises and other signs of damage or excessive wear. If internal damage to the tire is suspected, have the tire demounted and inspected in case it needs to be repaired or replaced. For your safety, tires that are damaged or show signs of excessive wear should not be used because they are more likely to blow out or fail.

Improper or inadequate vehicle maintenance can cause tires to wear abnormally. Inspect all your tires, including the spare, frequently, and replace them if one or more of the following conditions exist:

Tire wear

When the tread is worn down to 1/16th of an inch (2 mm), tires must be replaced to help prevent your vehicle from skidding and hydroplaning. Built-in treadwear indicators, or “wear bars”, which look like narrow strips of smooth rubber across the tread will appear on the tire when the tread is worn down to 1/16th of an inch (2 mm).

When the tire tread wears down to the same height as these “wear bars”, the tire is worn out and must be replaced.

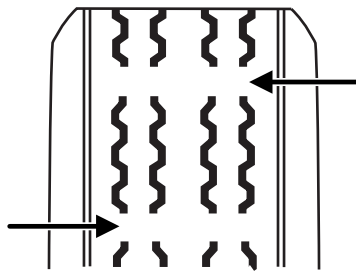

Damage

Periodically inspect the tire treads and sidewalls for damage (such as bulges in the tread or sidewalls, cracks in the tread groove and separation in the tread or sidewall). If damage is observed or suspected have the tire inspected by a tire professional. Tires can be damaged during off-road use, so inspection after off-road use is also recommended.



WARNING: Age

Tires degrade over time depending on many factors such as weather, storage conditions, and conditions of use (load, speed, inflation pressure, etc.) the tires experience throughout their lives. In general, tires should be replaced after six years regardless of tread wear. However, heat caused by hot climates or frequent high loading conditions can accelerate the aging process and may require tires to be replaced more frequently.

You should replace your spare tire when you replace the road tires or after six years due to aging even if it has not been used.

Tires, Wheels and Loading

U.S. DOT Tire Identification Number (TIN)

Both U.S. and Canada Federal regulations require tire manufacturers to place standardized information on the sidewall of all tires. This information identifies and describes the fundamental characteristics of the tire and also provides a U.S. DOT Tire Identification Number for safety standard certification and in case of a recall.

This begins with the letters "DOT" and indicates that the tire meets all federal standards. The next two numbers or letters are the plant code designating where it was manufactured, the next two are the tire size code and the last four numbers represent the week and year the tire was built. For example, the numbers 317 mean the 31st week of 1997. After 2000 the numbers go to four digits. For example, 2501 means the 25th week of 2001. The numbers in between are identification codes used for traceability. This information is used to contact customers if a tire defect requires a recall.

Tire replacement requirements

Your vehicle is equipped with tires designed to provide a safe ride and handling capability.



WARNING: Only use replacement tires and wheels that are the same size, load index, speed rating and type (such as P-metric versus LT-metric or all-season versus all-terrain) as those originally provided by Ford. The recommended tire and wheel size may be found on either the Safety Compliance Certification Label or the Tire Label which is located on the B-Pillar or edge of the driver's door. If this information is not found on these labels then you should contact your authorized dealer as soon as possible. Use of any tire or wheel not recommended by Ford can affect the safety and performance of your vehicle, which could result in an increased risk of loss of vehicle control, vehicle rollover, personal injury and death. Additionally the use of non-recommended tires and wheels could cause steering, suspension, axle or transfer case/power transfer unit failure. If you have questions regarding tire replacement, contact your authorized dealer as soon as possible.

Tires, Wheels and Loading



WARNING: When mounting replacement tires and wheels, you should not exceed the maximum pressure indicated on the sidewall of the tire to set the beads without additional precautions listed below. If the beads do not seat at the maximum pressure indicated, re-lubricate and try again.

When inflating the tire for mounting pressures up to 20 psi (1.38 bar) greater than the maximum pressure on the tire sidewall, the following precautions must be taken to protect the person mounting the tire:

1. Make sure that you have the correct tire and wheel size.
2. Lubricate the tire bead and wheel bead seat area again.
3. Stand at a minimum of 12 ft. (3.66 m) away from the tire wheel assembly.
4. Use both eye and ear protection.

For a mounting pressure more than 20 psi (1.38 bar) greater than the maximum pressure, a Ford Dealer or other tire service professional should do the mounting.

Always inflate steel carcass tires with a remote air fill with the person inflating standing at a minimum of 12 ft. (3.66 m) away from the tire wheel assembly.

Important: Remember to replace the wheel valve stems when the road tires are replaced on your vehicle.

It is recommended that the two front tires or two rear tires generally be replaced as a pair.

The tire pressure sensors mounted in the wheels (originally installed on your vehicle) are not designed to be used in aftermarket wheels.

The use of wheels or tires not recommended by Ford Motor Company may affect the operation of your Tire Pressure Monitoring System.

If the TPMS indicator is flashing, your TPMS is malfunctioning. Your replacement tire might be incompatible with your TPMS, or some component of the TPMS may be damaged.

Safety practices

Driving habits have a great deal to do with your tire mileage and safety.

- Observe posted speed limits
- Avoid fast starts, stops and turns
- Avoid potholes and objects on the road

Tires, Wheels and Loading

- Do not run over curbs or hit the tire against a curb when parking



WARNING: If your vehicle is stuck in snow, mud, sand, etc., **do not** rapidly spin the tires; spinning the tires can tear the tire and cause an explosion. A tire can explode in as little as three to five seconds.



WARNING: Do not spin the wheels at over 35 mph (56 km/h). The tires may fail and injure a passenger or bystander.

Highway hazards

No matter how carefully you drive there's always the possibility that you may eventually have a flat tire on the highway. Drive slowly to the closest safe area out of traffic. This may further damage the flat tire, but your safety is more important.

If you feel a sudden vibration or ride disturbance while driving, or you suspect your tire or vehicle has been damaged, immediately reduce your speed. Drive with caution until you can safely pull off the road. Stop and inspect the tires for damage. If a tire is under-inflated or damaged, deflate it, remove wheel and replace it with your spare tire and wheel. If you cannot detect a cause, have the vehicle towed to the nearest repair facility or tire dealer to have the vehicle inspected.

Tire and wheel alignment

A bad jolt from hitting a curb or pothole can cause the front end of your vehicle to become misaligned or cause damage to your tires. If your vehicle seems to pull to one side when you're driving, the wheels may be out of alignment. Have an authorized dealer check the wheel alignment periodically.

Wheel misalignment in the front or the rear can cause uneven and rapid treadwear of your tires and should be corrected by an authorized dealer. Front wheel drive (FWD) vehicles and those with an independent rear suspension (if equipped) may require alignment of all four wheels.

The tires should also be balanced periodically. An unbalanced tire and wheel assembly may result in irregular tire wear.

Tire rotation

Rotating your tires at the recommended interval (as indicated in the *scheduled maintenance information* that comes with your vehicle) will help your tires wear more evenly, providing better tire performance and longer tire life.

Tires, Wheels and Loading

- Rear Wheel Drive (RWD) vehicles/Four Wheel Drive (4WD)/ All Wheel Drive (AWD) vehicles (front tires at top of diagram)

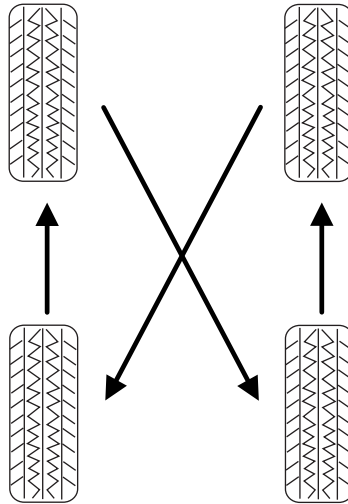

Sometimes irregular tire wear can be corrected by rotating the tires.

Note: If your tires show uneven wear ask an authorized dealer to check for and correct any wheel misalignment, tire imbalance or mechanical problem involved before tire rotation.

Note: Your vehicle may be equipped with a dissimilar spare tire/wheel. A dissimilar spare tire/wheel is defined as a spare tire and/or wheel that is different in brand, size or appearance from the road tires and wheels. If you have a dissimilar spare tire/wheel it is intended for temporary use only and should not be used in a tire rotation.

Note: After having your tires rotated, check tire pressure and adjust to the recommended inflation pressure.

Note: The TPMS reset tool is ONLY provided for vehicles with different front and rear tire pressures. The TPMS reset procedure needs to be performed after tire rotation only on these vehicles.

Tires, Wheels and Loading



WARNING: If the tire label shows different tire pressures for the front and rear tires and the vehicle is equipped with TPMS (tire pressure monitoring system), then the TPMS sensors need to be reset after tire rotation. If the system is not reset, it may not provide a low tire pressure warning when necessary. See the TPMS reset procedure in this chapter.

INFORMATION CONTAINED ON THE TIRE SIDEWALL

Both U.S. and Canada Federal regulations require tire manufacturers to place standardized information on the sidewall of all tires. This information identifies and describes the fundamental characteristics of the tire and also provides a U.S. DOT Tire Identification Number for safety standard certification and in case of a recall.

Information on “P” type tires

P215/65R15 95H is an example of a tire size, load index and speed rating. The definitions of these items are listed below. (Note that the tire size, load index and speed rating for your vehicle may be different from this example.)

1. **P:** Indicates a tire, designated by the Tire and Rim Association (T&RA), that may be used for service on cars, SUVs, minivans and light trucks.

Note: If your tire size does not begin with a letter this may mean it is designated by either ETRTO (European Tire and Rim Technical Organization) or JATMA (Japan Tire Manufacturing Association).

2. **215:** Indicates the nominal width of the tire in millimeters from sidewall edge to sidewall edge. In general, the larger the number, the wider the tire.

3. **65:** Indicates the aspect ratio which gives the tire’s ratio of height to width.

4. **R:** Indicates a “radial” type tire.

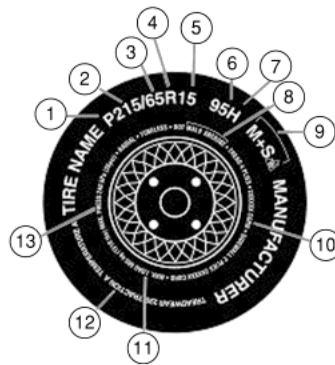

Tires, Wheels and Loading

5. **15:** Indicates the wheel or rim diameter in inches. If you change your wheel size, you will have to purchase new tires to match the new wheel diameter.

6. **95:** Indicates the tire's load index. It is an index that relates to how much weight a tire can carry. You may find this information in your *Owner's Guide*. If not, contact a local tire dealer.

Note: You may not find this information on all tires because it is not required by federal law.

7. **H:** Indicates the tire's speed rating. The speed rating denotes the speed at which a tire is designed to be driven for extended periods of time under a standard condition of load and inflation pressure. The tires on your vehicle may operate at different conditions for load and inflation pressure. These speed ratings may need to be adjusted for the difference in conditions. The ratings range from 81 mph (130 km/h) to 186 mph (299 km/h). These ratings are listed in the following chart.

Note: You may not find this information on all tires because it is not required by federal law.

Letter rating	Speed rating - mph (km/h)
M	81 mph (130 km/h)
N	87 mph (140 km/h)
Q	99 mph (159 km/h)
R	106 mph (171 km/h)
S	112 mph (180 km/h)
T	118 mph (190 km/h)
U	124 mph (200 km/h)
H	130 mph (210 km/h)
V	149 mph (240 km/h)
W	168 mph (270 km/h)
Y	186 mph (299 km/h)

Note: For tires with a maximum speed capability over 149 mph (240 km/h), tire manufacturers sometimes use the letters ZR. For those with a maximum speed capability over 186 mph (299 km/h), tire manufacturers always use the letters ZR.

Tires, Wheels and Loading

8. **U.S. DOT Tire Identification Number (TIN):** This begins with the letters “DOT” and indicates that the tire meets all federal standards. The next two numbers or letters are the plant code designating where it was manufactured, the next two are the tire size code and the last four numbers represent the week and year the tire was built. For example, the numbers 317 mean the 31st week of 1997. After 2000 the numbers go to four digits. For example, 2501 means the 25th week of 2001. The numbers in between are identification codes used for traceability. This information is used to contact customers if a tire defect requires a recall.

9. **M+S or M/S:** Mud and Snow, or

AT: All Terrain, or

AS: All Season.

10. **Tire Ply Composition and Material Used:** Indicates the number of plies or the number of layers of rubber-coated fabric in the tire tread and sidewall. Tire manufacturers also must indicate the ply materials in the tire and the sidewall, which include steel, nylon, polyester, and others.

11. **Maximum Load:** Indicates the maximum load in kilograms and pounds that can be carried by the tire. Refer to the Safety Compliance Certification Label, which is located on the B-Pillar or the edge of the driver’s door, for the correct tire pressure for your vehicle.

12. Treadwear, Traction and Temperature Grades

- **Treadwear:** The treadwear grade is a comparative rating based on the wear rate of the tire when tested under controlled conditions on a specified government test course. For example, a tire graded 150 would wear one and one-half (1½) times as well on the government course as a tire graded 100.
- **Traction:** The traction grades, from highest to lowest are AA, A, B, and C. The grades represent the tire’s ability to stop on wet pavement as measured under controlled conditions on specified government test surfaces of asphalt and concrete. A tire marked C may have poor traction performance.
- **Temperature:** The temperature grades are A (the highest), B and C, representing the tire’s resistance to the generation of heat and its ability to dissipate heat when tested under controlled conditions on a specified indoor laboratory test wheel.

Tires, Wheels and Loading

13. Maximum Permissible Inflation Pressure: Indicates the tire manufacturers' maximum permissible pressure and/or the pressure at which the maximum load can be carried by the tire. This pressure is normally higher than the manufacturer's recommended cold inflation pressure which can be found on the Safety Compliance Certification Label or Tire Label which is located on the B-Pillar or the edge of the driver's door. The cold inflation pressure should never be set lower than the recommended pressure on the vehicle label.

The tire suppliers may have additional markings, notes or warnings such as standard load, radial tubeless, etc.

Additional information contained on the tire sidewall for "LT" type tires

"LT" type tires have some additional information beyond those of "P" type tires; these differences are described below.

Note: Tire Quality Grades do not apply to this type of tire.

1. **LT:** Indicates a tire, designated by the Tire and Rim Association (T&RA), that is intended for service on light trucks.

2. Load Range/Load Inflation

Limits: Indicates the tire's load-carrying capabilities and its inflation limits.

3. **Maximum Load Dual lb. (kg) at psi (kPa) cold:** Indicates the maximum load and tire pressure when the tire is used as a dual; defined as four tires on the rear axle (a total of six or more tires on the vehicle).

4. **Maximum Load Single lb. (kg) at psi (kPa) cold:** Indicates the maximum load and tire pressure when the tire is used as a single; defined as two tires (total) on the rear axle.

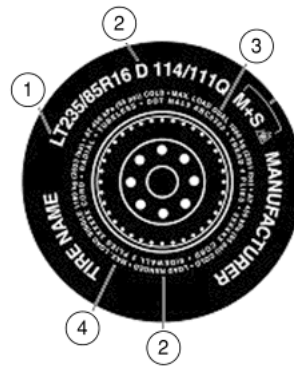

Tires, Wheels and Loading

Information on “T” type tires

“T” type tires have some additional information beyond those of “P” type tires; these differences are described below:

T145/80D16 is an example of a tire size.

Note: The temporary tire size for your vehicle may be different from this example. Tire Quality Grades do not apply to this type of tire.

1. **T:** Indicates a type of tire, designated by the Tire and Rim Association (T&RA), that is intended for temporary service on cars, SUVs, minivans and light trucks.

2. **145:** Indicates the nominal width of the tire in millimeters from sidewall edge to sidewall edge. In general, the larger the number, the wider the tire.

3. **80:** Indicates the aspect ratio which gives the tire’s ratio of height to width. Numbers of 70 or lower indicate a short sidewall.

4. **D:** Indicates a “diagonal” type tire.

R: Indicates a “radial” type tire.

5. **16:** Indicates the wheel or rim diameter in inches. If you change your wheel size, you will have to purchase new tires to match the new wheel diameter.

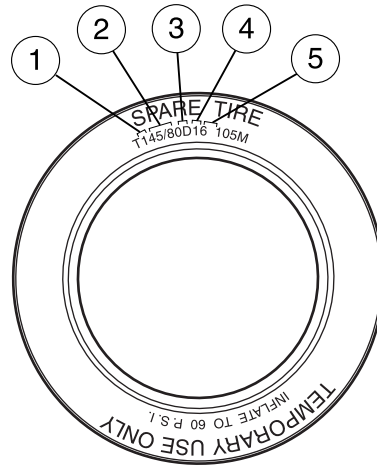

Location of the tire label

You will find a Tire Label containing tire inflation pressure by tire size and other important information located on the B-Pillar or the edge of the driver’s door. Refer to the payload description and graphic in the *Vehicle loading — with and without a trailer* section.

Tires, Wheels and Loading

TIRE PRESSURE MONITORING SYSTEM (TPMS) (IF EQUIPPED)

Each tire, including the spare (if provided), should be checked monthly when cold and inflated to the inflation pressure recommended by the vehicle manufacturer on the



vehicle placard or tire inflation pressure label. (If your vehicle has tires of a different size than the size indicated on the vehicle placard or tire inflation pressure label, you should determine the proper tire inflation pressure for those tires.)

As an added safety feature, your vehicle has been equipped with a tire pressure monitoring system (TPMS) that illuminates a low tire pressure telltale when one or more of your tires is significantly under-inflated. Accordingly, when the low tire pressure telltale illuminates, you should stop and check your tires as soon as possible, and inflate them to the proper pressure. Driving on a significantly under-inflated tire causes the tire to overheat and can lead to tire failure. Under-inflation also reduces fuel efficiency and tire tread life, and may affect the vehicle's handling and stopping ability.

Please note that the TPMS is not a substitute for proper tire maintenance, and it is the driver's responsibility to maintain correct tire pressure, even if under-inflation has not reached the level to trigger illumination of the TPMS low tire pressure telltale.

Your vehicle has also been equipped with a TPMS malfunction indicator to indicate when the system is not operating properly. The TPMS malfunction indicator is combined with the low tire pressure telltale. When the system detects a malfunction, the telltale will flash for approximately one minute and then remain continuously illuminated. This sequence will continue upon subsequent vehicle start-ups as long as the malfunction exists.

When the malfunction indicator is illuminated, the system may not be able to detect or signal low tire pressure as intended. TPMS malfunctions may occur for a variety of reasons, including the installation of replacement or alternate tires or wheels on the vehicle that prevent the TPMS from functioning properly. Always check the TPMS malfunction telltale after replacing one or more tires or wheels on your vehicle to ensure that the replacement or alternate tires and wheels allow the TPMS to continue to function properly.

Tires, Wheels and Loading

The Tire Pressure Monitoring System complies with part 15 of the FCC rules and with RSS-210 of Industry Canada. Operation is subject to the following two conditions: (1) This device may not cause harmful interference, and (2) This device must accept any interference received, including interference that may cause undesired operation.

! **WARNING:** The Tire Pressure Monitoring System is NOT a substitute for manually checking tire pressure. The tire pressure should be checked periodically (at least monthly) using a tire gauge, see *Inflating your tires* in this chapter. Failure to properly maintain your tire pressure could increase the risk of tire failure, loss of control, vehicle rollover and personal injury.

Changing tires with TPMS

Each road tire is equipped with a tire pressure sensor located inside the tire/wheel cavity. The pressure sensor is attached to the valve stem. The pressure sensor is covered by the tire and is not visible unless the tire is removed. Care must be taken when changing the tire to avoid damaging the sensor. It is

recommended that you always have your tires serviced by an authorized dealer.

The tire pressure should be checked periodically (at least monthly) using an accurate tire gauge, refer to *Inflating your tires* in this chapter.

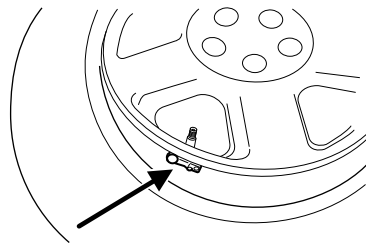

Tires, Wheels and Loading

Understanding your Tire Pressure Monitoring System (TPMS)

The Tire Pressure Monitoring System measures pressure in your four road tires and sends the tire pressure readings to your vehicle. The Low Tire Warning Lamp will turn ON if the tire pressure is significantly low. Once the light is illuminated, your tires are under inflated and need to be inflated to the manufacturer's recommended tire pressure. Even if the light turns ON and a short time later turns OFF, your tire pressure still needs to be checked. Visit www.checkmytires.org for additional information.

When your temporary spare tire is installed

When one of your road tires needs to be replaced with the temporary spare, the TPMS system will continue to identify an issue to remind you that the damaged road wheel/tire needs to be repaired and put back on your vehicle.

To restore the full functionality of the Tire Pressure Monitoring System, have the damaged road wheel/tire repaired and remounted on your vehicle. For additional information, refer to *Changing tires with TPMS* in this section.

Tires, Wheels and Loading

When you believe your system is not operating properly

The main function of the Tire Pressure Monitoring System is to warn you when your tires need air. It can also warn you in the event the system is no longer capable of functioning as intended. Please refer to the following chart for information concerning your Tire Pressure Monitoring System:

Low Tire Pressure Warning Light	Possible cause	Customer Action Required
Solid Warning Light	Tire(s) under-inflated	1. Check your tire pressure to ensure tires are properly inflated; refer to <i>Inflating your tires</i> in this chapter. 2. After inflating your tires to the manufacturer's recommended inflation pressure as shown on the Tire Label (located on the edge of driver's door or the B-Pillar), the vehicle must be driven for at least two minutes over 20 mph (32 km/h) before the light will turn OFF.
	Spare tire in use	Your temporary spare tire is in use. Repair the damaged road wheel/tire and reinstall it on the vehicle to restore system functionality. For a description on how the system functions, refer to <i>When your temporary spare tire is installed</i> in this section.
	TPMS malfunction	If your tires are properly inflated and your spare tire is not in use and the light remains ON, have the system inspected by your authorized dealer.
	Tire rotation without sensor training	On vehicles with different front and rear tire pressures, the TPMS system must be retrained following every tire rotation. Refer to <i>Tire rotation</i> in this chapter.

Tires, Wheels and Loading

Low Tire Pressure Warning Light	Possible cause	Customer Action Required
Flashing Warning Light	Spare tire in use	Your temporary spare tire is in use. Repair the damaged road wheel and re-mount it on the vehicle to restore system functionality. For a description of how the system functions under these conditions, refer to <i>When your temporary spare tire is installed</i> in this section.
	TPMS malfunction	If your tires are properly inflated and your spare tire is not in use and the TPMS warning light still flashes, have the system inspected by your authorized dealer.

When inflating your tires

When putting air into your tires (such as at a gas station or in your garage), the Tire Pressure Monitoring System may not respond immediately to the air added to your tires.

It may take up to two minutes of driving over 20 mph (32 km/h) for the light to turn OFF after you have filled your tires to the recommended inflation pressure.

How temperature affects your tire pressure

The Tire Pressure Monitoring System (TPMS) monitors tire pressure in each pneumatic tire. While driving in a normal manner, a typical passenger tire inflation pressure may increase approximately 2 to 4 psi (14 to 28 kPa) from a cold start situation. If the vehicle is stationary over night with the outside temperature significantly lower than the daytime temperature, the tire pressure may decrease approximately 3 psi (20.7 kPa) for a drop of 30° F (16.6°C) in ambient temperature. This lower pressure value may be detected by the TPMS as being significantly lower than the recommended inflation pressure and activate the TPMS warning for low tire pressure. If the low tire pressure warning light is ON, visually check each tire to verify that no tire is flat. (If one or more tires are flat, repair as necessary.) Check air pressure in the road tires. If any tire is under-inflated, carefully drive the vehicle to the nearest location where air can be added to the tires. Inflate all the tires to the recommended inflation pressure.

Tires, Wheels and Loading

TPMS reset procedure (if applicable)

The TPMS reset tool is ONLY provided for vehicles with different front and rear tire pressures. The TPMS reset procedure needs to be performed after tire rotation only on these vehicles.



WARNING: To determine if your vehicle has different recommended pressures for the front and rear tires, refer to the Safety Compliance Certification Label or Tire Label which is located on the B-Pillar or the edge of the driver's door. See *Vehicle Loading* in this chapter for more information.

Overview

To provide the vehicle's load carrying capability, some trucks require different recommended tire pressures in the front tires as compared to the rear tires. The Tire Pressure Monitoring System (TPMS) equipped on these vehicles is designed to illuminate the Low Tire Pressure Warning indicator at two different pressures; one for the front tires and one for the rear tires.

Since tires need to be rotated to provide consistent performance and maximum tire life, the Tire Pressure Monitoring System needs to know when the tires are rotated to determine which set of tires are on the front and which are on the rear. With this information, the system can detect and properly warn of low tire pressures.



WARNING: Always perform the TPMS reset procedure after tire rotation when recommended pressures are different for the front and rear tires.

TPMS reset tool

A special TPMS reset tool to reset your TPMS after tire rotation is provided with vehicles that have different front and rear tire pressures. The tool is located with your Owner's Guide materials.

Tires, Wheels and Loading

Please take the tool with the provided Velcro® strip on the back and mount it in the bottom right corner of your Owner's Guide case (as shown) for safe keeping.

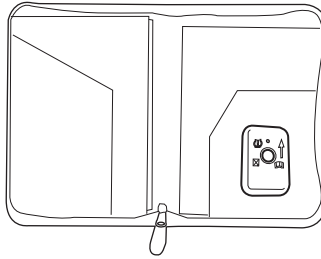

If you find that the reset tool was not provided when delivered, has been lost or no longer functions (the battery is not replaceable), please contact your authorized dealer to obtain a replacement.

To verify that your TPMS reset tool is working, press and release the button on the center of the TPMS tool. The red light should illuminate and remain on for approximately five (5) seconds. If the light does not illuminate, the tool needs to be replaced.

TPMS reset tips:

- To reduce the chances of interference from another vehicle, TPMS reset should be performed at least three feet (one meter) away from another Ford Motor Company vehicle undergoing the TPMS reset procedure at the same time.
- Do not wait more than two (2) minutes between resetting each tire sensor or the system will timeout and the entire procedure will have to be repeated on all four wheels.
- A double horn chirp indicates the need to repeat the procedure.

TPMS reset procedure

It is recommended that you read the entire procedure before attempting.

Note: To enter the reset mode, Steps 1–6 **MUST** be completed within 60 seconds.

1. Place the ignition in the off position and keep the key in the ignition.

Tires, Wheels and Loading

2. Press and release the brake pedal.

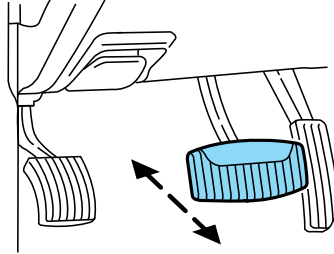

3. Cycle the ignition from off to on three (3) times ending in the on position—**DO NOT** start the engine.

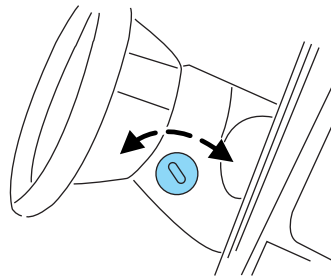

4. Press and hold the brake pedal for two (2) seconds, then release.

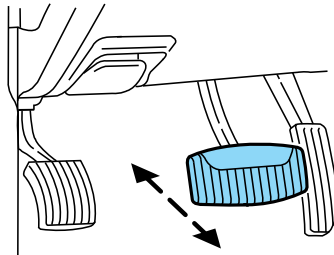

Tires, Wheels and Loading

5. Turn the ignition to off—**DO NOT** remove the key.

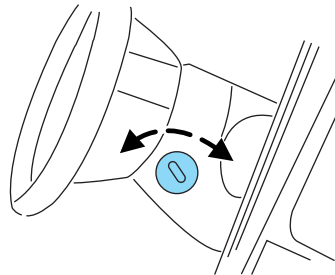

6. Cycle the ignition from off to on three (3) times ending in on—**DO NOT** start the engine.

If the reset mode has been entered successfully, the horn will sound once, the TPMS indicator (⚠) will flash and the message center will display **TRAIN LEFT FRONT TIRE**.

If after repeated attempts to enter the reset mode, the horn does not sound, the TPMS indicator (⚠) does not flash and the message center does not display **TRAIN LEFT FRONT TIRE**, seek service from your authorized dealer.

7. Train the TPMS sensors in the tires using the following TPMS reset sequence starting with the **left front tire** in the following clockwise order:

Tires, Wheels and Loading

1. Left front tire (Front driver's side)
2. Right front tire (Front passenger's side)
3. Right rear tire (Rear passenger's side)
4. Left rear tire (Rear driver's side)

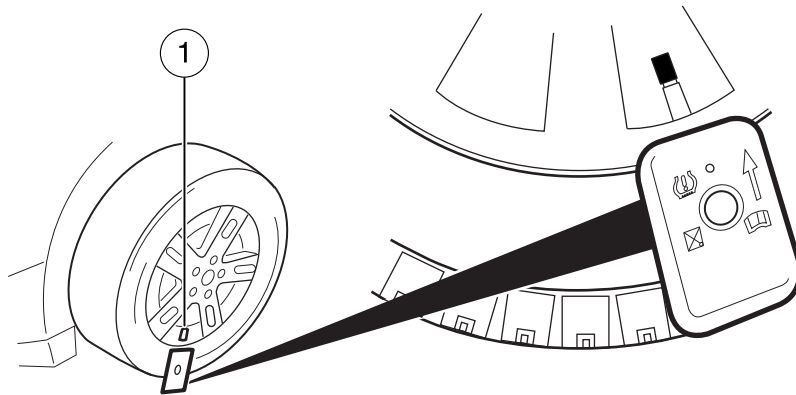

8. **Left front tire:** Place the TPMS reset tool against the left front tire where the tire meets the rim, right near the valve stem (1) as shown. This is where the sensor is located inside the rim.

The tool needs to be held against the tire sidewall right near the valve stem as illustrated with the arrow on the tool pointing towards the rim; do not use the tool with the arrow pointing away from the rim as it may not activate the sensor.

9. Press and release the green button and hold the tool to the tire sidewall until the horn sounds. The red light on the TPMS reset tool will illuminate while the tool is active. The horn will sound once within 10 seconds to indicate the process was successful.

Note:

- If a double horn chirp is heard, repeat the procedure. If a single horn chirp is not heard, move the vehicle to rotate the wheels at least a $\frac{1}{4}$ -turn and repeat the procedure starting with Step 1.
- If a double horn chirp is heard even after the wheels were repositioned, seek service from your authorized dealer.

Tires, Wheels and Loading

10. Perform Steps 8 and 9 on the right front tire, right rear tire and finally the left rear tire. Training is complete after the horn sounds for the last tire trained (left rear tire) and the message center displays: **TRAINING COMPLETE.**

Turn the ignition to off. If two short horn beeps are heard, the reset procedure was unsuccessful and must be repeated.

If after repeating the procedure and two short beeps are heard when the ignition is turned to off, seek assistance from your authorized dealer.

SNOW TIRES AND CHAINS



WARNING: Snow tires must be the same size, load index, speed rating as those originally provided by Ford. Use of any tire or wheel not recommended by Ford can affect the safety and performance of your vehicle, which could result in an increased risk of loss of vehicle control, vehicle rollover, personal injury and death. Additionally, the use of non-recommended tires and wheels could cause steering, suspension, axle or transfer case/power transfer unit failure.

The tires on your vehicle have all-weather treads to provide traction in rain and snow. However, in some climates, you may need to use snow tires and chains. If you need to use chains, it is recommended that steel wheels (of the same size and specifications) be used, as chains may chip aluminum wheels.

Note: Do not place chains on the following tires sizes: P265/60R18, P275/65R18, LT275/70R17, LT275/65R18, P275/55R20, and P275/45R22.

Follow these guidelines when using snow tires and chains:

- Use only SAE Class S chains.
- Install chains securely, verifying that the chains do not touch any wiring, brake lines or fuel lines.
- Drive cautiously. If you hear the chains rub or bang against your vehicle, stop and re-tighten the chains. If this does not work, remove the chains to prevent damage to your vehicle.
- If possible, avoid fully loading your vehicle.
- Remove the tire chains when they are no longer needed. Do not use tire chains on dry roads.
- The suspension insulation and bumpers will help prevent vehicle damage. Do not remove these components from your vehicle when using snow tires and chains.

Tires, Wheels and Loading

VEHICLE LOADING – WITH AND WITHOUT A TRAILER

This section will guide you in the proper loading of your vehicle and/or trailer, to keep your loaded vehicle weight within its design rating capability, with or without a trailer. Properly loading your vehicle will provide maximum return of vehicle design performance. Before loading your vehicle, familiarize yourself with the following terms for determining your vehicle's weight ratings, with or without a trailer, from the vehicle's Tire Label or Safety Compliance Certification Label:

Base Curb Weight – is the weight of the vehicle including a full tank of fuel and all standard equipment. It does not include passengers, cargo, or optional equipment.

Vehicle Curb Weight – is the weight of your new vehicle when you picked it up from your authorized dealer plus any aftermarket equipment.

Tires, Wheels and Loading

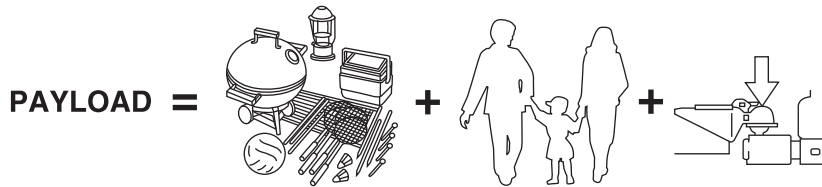

Payload – is the combined weight of cargo and passengers that the vehicle is carrying. The maximum payload for your vehicle can be found on the Tire Label on the B-Pillar or the edge of the driver's door (vehicles exported outside the US and Canada may not have a Tire Label). Look for **“THE COMBINED WEIGHT OF OCCUPANTS AND CARGO SHOULD NEVER EXCEED XXX kg OR XXX lb.”** for maximum payload. The payload listed on the Tire Label is the maximum payload for the vehicle as built by the assembly plant. If any aftermarket or authorized-dealer installed equipment has been installed on the vehicle, the weight of the equipment must be subtracted from the payload listed on the Tire Label in order to determine the new payload.

! **WARNING:** The appropriate loading capacity of your vehicle can be limited either by volume capacity (how much space is available) or by payload capacity (how much weight the vehicle should carry). Once you have reached the maximum payload of your vehicle, do not add more cargo, even if there is space available. Overloading or improperly loading your vehicle can contribute to loss of vehicle control and vehicle rollover.

Tires, Wheels and Loading

Example only:

TIRE AND LOADING INFORMATION				
SEATING CAPACITY		TOTAL 5	FRONT 2	REAR 3
The combined weight of occupants and cargo should never exceed : XXX kg or XXX lbs.				
TIRE	SIZE	COLD TIRE PRESSURE	SEE OWNERS MANUAL FOR ADDITIONAL INFORMATION	
FRONT	LT225/75R 16.5E	200 KPA, 29 PSI		
REAR	LT225/75R 16.5E	200 KPA, 29 PSI		
SPARE	T145/80D16 P225/60R17	420 KPA, 60 PSI 200 KPA, 29 PSI		

TIRE AND LOAD INFORMATION				
SEATING CAPACITY		TOTAL XX	FRONT XX	REAR X
NOMBRE DE PLACES		TOTAL	AVANT	ARRIERE
The combined weight of occupants and cargo should never exceed : XXX kg. La charge du véhicule (occupants et bagages) ne doit jamais dépasser : XXX lbs.				
TIRE PNEUS	SIZE DIMENSIONS	COLD TIRE PRESSURE PRESSION A FROID	SEE OWNERS MANUAL FOR ADDITIONAL INFORMATION CONSULTER LE GUIDE DU PROPRIETAIRE POUR DE PLUS AMPLES RENSEIGNEMENTS	
FRONT/ AVANT	LT225/75R 16.5E	200 KPA, 29 PSI		
REAR/ ARRIERE	LT225/75R 16.5E	200 KPA, 29 PSI		
SPARE/ PNEU DE SECOURS	T145/80D16 P225/60R17	420 KPA, 60 PSI 200 KPA, 29 PSI		

CARGO

=



+

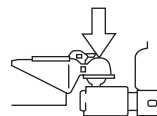

Cargo Weight – includes all weight added to the Base Curb Weight, including cargo and optional equipment. When towing, trailer tongue load or king pin weight is also part of cargo weight.

GAW (Gross Axle Weight) – is the total weight placed on each axle (front and rear) – including vehicle curb weight and all payload.

Tires, Wheels and Loading

GAWR (Gross Axle Weight Rating) – is the maximum allowable weight that can be carried by a single axle (front or rear). **These numbers are shown on the Safety Compliance Certification Label located on the B-Pillar or the edge of the driver's door. The total load on each axle must never exceed its GAWR.**

Note: For trailer towing information refer to *Trailer towing* found in this chapter or the *RV and Trailer Towing Guide* provided by your authorized dealer.

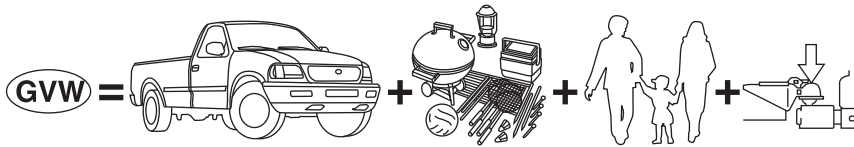

GVW (Gross Vehicle Weight) – is the Vehicle Curb Weight + cargo + passengers.

MFD. BY FORD MOTOR CO.			
DATE: XX/XX	GVWR: XXXXXLB/ XXXXXKG		
FRONT GAWR: XXXXL	REAR GAWR: XXXXLB		
XXXXKG	WITH	XXXXKG	WITH
XXXX/XXXXXX	TIRES	XXXX/XXXXXX	TIRES
XXXX.XX	RIMS	XXXX.XX	RIMS
AT XXX kPa/XX	PSI COLD	AT XXX kPa/XX	PSI COLD
THIS VEHICLE CONFORMS TO ALL APPLICABLE FEDERAL MOTOR VEHICLE SAFETY AND THEFT PREVENTION STANDARDS IN EFFECT ON THE DATE OF MANUFACTURE SHOWN ABOVE.			
VIN: XXXXXXXXXXXXXXXXXXXX	XXXXXX XXXXXX		
TYPE: XXX			
EXT PNT: XX	RC: XX	DSO:	
WB ¹ BRK ¹ INT TR ¹ TP/PS ¹ R ¹ AXLE ¹ TR SPR ¹ XXXXX			
XXX X XX X XX X XX XXX			
XXXXXXXXXXXXXXXX XXX XXXX-XXXXXX-XX			

GVWR (Gross Vehicle Weight Rating) – is the maximum allowable weight of the fully loaded vehicle (including all options, equipment, passengers and cargo). **The GVWR is shown on the Safety Compliance Certification Label located on the B-Pillar or the edge of the driver's door. The GVW must never exceed the GVWR.**

Tires, Wheels and Loading

 **WARNING:** Exceeding the Safety Compliance Certification Label vehicle weight rating limits could result in substandard vehicle handling or performance, engine, transmission and/or structural damage, serious damage to the vehicle, loss of control and personal injury.



GCW (Gross Combined Weight) – is the weight of the loaded vehicle (GVW) plus the weight of the fully loaded trailer.

GCWR (Gross Combined Weight Rating) – is the maximum allowable weight of the vehicle and the loaded trailer – including all cargo and passengers – that the vehicle can handle without risking damage. (Important: The towing vehicle's braking system is rated for operation at GVWR, not at GCWR.) Separate functional brakes should be used for safe control of towed vehicles and for trailers where the GCW of the towing vehicle plus the trailer exceed the GVWR of the towing vehicle.

The GCW must never exceed the GCWR.

Maximum Loaded Trailer Weight – is the highest possible weight of a fully loaded trailer the vehicle can tow. It assumes a vehicle with only mandatory options, no cargo (internal or external), a tongue load of 10–15% (conventional trailer) or king pin weight of 15–25% (fifth wheel trailer), and driver only (150 lb. [68 kg]). **Consult your authorized dealer (or the *RV and Trailer Towing Guide* provided by your authorized dealer) for more detailed information.**

Tongue Load or Fifth Wheel King Pin Weight – refers to the amount of the weight that a trailer pushes down on a trailer hitch.

Examples: For a 5,000 lb. (2,268 kg) conventional trailer, multiply 5,000 by 0.10 and 0.15 to obtain a proper tongue load range of 500 to 750 lb. (227 to 340 kg). For an 11,500 lb. (5,216 kg) fifth wheel trailer, multiply by 0.15 and 0.25 to obtain a proper king pin load range of 1,725 to 2,875 lb. (782 to 1,304 kg)

 **WARNING:** Do not exceed the GVWR or the GAWR specified on the Safety Compliance Certification Label.

Tires, Wheels and Loading



WARNING: Do not use replacement tires with lower load carrying capacities than the original tires because they may lower the vehicle's GVWR and GAWR limitations. Replacement tires with a higher limit than the original tires do not increase the GVWR and GAWR limitations.



WARNING: Exceeding any vehicle weight rating limitation could result in serious damage to the vehicle and/or personal injury.

Steps for determining the correct load limit:

1. Locate the statement "The combined weight of occupants and cargo should never exceed XXX kg or XXX lb." on your vehicle's placard.
2. Determine the combined weight of the driver and passengers that will be riding in your vehicle.
3. Subtract the combined weight of the driver and passengers from XXX kg or XXX lb.
4. The resulting figure equals the available amount of cargo and luggage load capacity. For example, if the "XXX" amount equals 1,400 lb. and there will be five 150 lb. passengers in your vehicle, the amount of available cargo and luggage load capacity is 650 lb. ($1400 - 750 (5 \times 150) = 650$ lb.). In metric units ($635 - 340 (5 \times 68) = 295$ kg.)
5. Determine the combined weight of luggage and cargo being loaded on the vehicle. That weight may not safely exceed the available cargo and luggage load capacity calculated in Step 4.
6. If your vehicle will be towing a trailer, load from your trailer will be transferred to your vehicle. Consult this manual to determine how this reduces the available cargo and luggage load capacity of your vehicle.

The following gives you a few examples on how to calculate the available amount of cargo and luggage load capacity:

- Another example for your vehicle with 1,400 lb. (635 kg) of cargo and luggage capacity. You decide to go golfing. Is there enough load capacity to carry you, 4 of your friends and all the golf bags? You and four friends average 220 lb. (99 kg) each and the golf bags weigh approximately 30 lb. (13.5 kg) each. The calculation would be: $1400 - (5 \times 220) - (5 \times 30) = 1400 - 1100 - 150 = 150$ lb. Yes, you have enough load capacity in your vehicle to transport four friends and your golf bags. In metric units, the calculation would be: $635 \text{ kg} - (5 \times 99 \text{ kg}) - (5 \times 13.5 \text{ kg}) = 635 - 495 - 67.5 = 72.5$ kg.

Tires, Wheels and Loading

- A final example for your vehicle with 1,400 lb. (635 kg) of cargo and luggage capacity. You and one of your friends decide to pick up cement from the local home improvement store to finish that patio you have been planning for the past 2 years. Measuring the inside of the vehicle with the rear seat folded down, you have room for 12-100 lb. (45 kg) bags of cement. Do you have enough load capacity to transport the cement to your home? If you and your friend each weigh 220 lb. (99 kg), the calculation would be: $1400 - (2 \times 220) - (12 \times 100) = 1400 - 440 - 1200 = -240$ lb. No, you do not have enough cargo capacity to carry that much weight. In metric units, the calculation would be: $635 \text{ kg} - (2 \times 99 \text{ kg}) - (12 \times 45 \text{ kg}) = 635 - 198 - 540 = -103$ kg. You will need to reduce the load weight by at least 240 lb. (104 kg). If you remove 3-100 lb. (45 kg) cement bags, then the load calculation would be:

$1400 - (2 \times 220) - (9 \times 100) = 1400 - 440 - 900 = 60$ lb. Now you have the load capacity to transport the cement and your friend home. In metric units, the calculation would be: $635 \text{ kg} - (2 \times 99 \text{ kg}) - (9 \times 45 \text{ kg}) = 635 - 198 - 405 = 32$ kg.

The above calculations also assume that the loads are positioned in your vehicle in a manner that does not overload the Front or the Rear Gross Axle Weight Rating specified for your vehicle on the Safety Compliance Certification Label found on the edge of the driver's door.

Special loading instructions for owners of pickup trucks and utility-type vehicles



WARNING: For important information regarding safe operation of this type of vehicle, see the *Preparing to drive your vehicle* section in the *Driving* chapter of this *Owner's Guide*.



WARNING: Loaded vehicles may handle differently than unloaded vehicles. Extra precautions, such as slower speeds and increased stopping distance, should be taken when driving a heavily loaded vehicle.

Your vehicle can haul more cargo and people than most passenger cars. Depending upon the type and placement of the load, hauling cargo and people may raise the center of gravity of the vehicle.

TRAILER TOWING

Your vehicle may tow a class I, II, III or IV trailer provided the maximum trailer weight is less than or equal to the maximum trailer weight listed for your engine and rear axle ratio on the following charts.

Tires, Wheels and Loading

If your vehicle is not equipped with a heavy-duty trailer towing package, the maximum weight your vehicle can tow is limited to 5,000 lb. (2,268 kg)

Your vehicle's load capacity is designated by weight, not by volume, so you cannot necessarily use all available space when loading a vehicle.

Towing a trailer places an additional load on your vehicle's engine, transmission, axle, brakes, tires and suspension. Inspect these components carefully periodically during, and after any towing operation.

Exceeding the maximum GCWR could result in extensive damage to your vehicle and personal injury.



WARNING: Do not exceed the GVWR or the GAWR specified on the certification label.



WARNING: Towing trailers beyond the maximum recommended gross trailer weight exceeds the limit of the vehicle and could result in engine damage, transmission damage, structural damage, loss of vehicle control, vehicle rollover and personal injury.

Regular Cab 4x2 (126" wheelbase)			
Engine	Rear axle ratio	Maximum GCWR-lb. (kg)	Maximum trailer weight-lb. (kg)
4.6L 2V	3.55	10400 (4717)	5400 (2449)
	3.73	10900 (4944)	5900 (2676)
Regular Cab 4x4 (126" wheelbase)			
Engine	Rear axle ratio	Maximum GCWR-lb. (kg)	Maximum trailer weight-lb. (kg)
4.6L 2V	3.73	10900 (4944)	5700 (2585)
4.6L 3V	3.55	12900 (5851)	7700 (3493)
	3.73	13300 (6033)	8000 (3629)
5.4L	3.31	13000 (5897)	7700 (3493)
	3.55	13900 (6305)	8600 (3901)
	3.73	13900 (6305)	8600 (3901)

Tires, Wheels and Loading

Regular Cab 4x2 (145" wheelbase)			
Engine	Rear axle ratio	Maximum GCWR-lb. (kg)	Maximum trailer weight-lb. (kg)
4.6L 2V	3.55	10600 (4808)	5500 (2495)
	3.73	11100 (5035)	6000 (2722)
4.6L 3V	3.31	13100 (5942)	8000 (3629)
	3.55	13600 (6169)	8400 (3810)
5.4L	3.15	13200 (5987)	8000 (3629)
	3.55	15000 (6804)	9800 (4445)
5.4L (Heavy Duty)	3.73	16700 (7575)	11300 (5126)

Regular Cab 4x4 (145" wheelbase)			
Engine	Rear axle ratio	Maximum GCWR-lb. (kg)	Maximum trailer weight-lb. (kg)
4.6L 2V	3.73	11100 (5035)	5500 (2495)
4.6L 3V	3.55	13100 (5942)	7800 (3538)
	3.73	12600 (5715)	8200 (3719)
5.4L	3.31	13200 (5987)	7800 (3538)
	3.55	15000 (6804)	9500 (4309)
	3.73	15000 (6804)	9500 (4309)
5.4L (Heavy Duty)	3.73	17000 (7711)	11300 (5126)

SuperCab 4x2 (133" wheelbase)			
Engine	Rear axle ratio	Maximum GCWR-lb. (kg)	Maximum trailer weight-lb. (kg)
4.6L 2V	3.55	10400 (4717)	5200 (2359)
	3.73	10900 (4944)	5700 (2585)
4.6L 3V	3.31	13000 (5897)	7800 (3538)
	3.55	13500 (6123)	8200 (3719)

Tires, Wheels and Loading

SuperCab 4x2 (133" wheelbase)			
Engine	Rear axle ratio	Maximum GCWR-lb. (kg)	Maximum trailer weight-lb. (kg)
5.4L	3.15	13200 (5987)	7800 (3538)
	3.55	14000 (6350)	8600 (3901)
SuperCab 4x4 (133" wheelbase)			
Engine	Rear axle ratio	Maximum GCWR-lb. (kg)	Maximum trailer weight-lb. (kg)
4.6L 2V	3.73	10900 (4944)	5400 (2449)
4.6L 3V	3.55	13000 (5897)	7500 (3402)
	3.73	13500 (6123)	8000 (3629)
5.4L	3.31	13200 (5987)	7600 (3447)
	3.55	14000 (6350)	8400 (3810)
	3.73	14000 (6350)	8400 (3810)
SuperCab 4x2 (145" wheelbase)			
Engine	Rear axle ratio	Maximum GCWR-lb. (kg)	Maximum trailer weight-lb. (kg)
4.6L 2V	3.55	10600 (4808)	5300 (24004)
	3.73	11100 (5035)	5800 (2631)
4.6L 3V	3.31	13500 (6123)	8200 (3719)
	3.55	14900 (6759)	9500 (4309)
5.4L	3.15	14000 (6350)	8600 (3900)
	3.55	15200 (6895)	9800 (4445)
	3.73	16900 (7666)	11300 (5126)

Tires, Wheels and Loading

SuperCab 4x4 (145" wheelbase)			
Engine	Rear axle ratio	Maximum GCWR-lb. (kg)	Maximum trailer weight-lb. (kg)
4.6L 2V	3.73	11100 (5035)	5500 (2495)
4.6L 3V	3.55	13500 (6123)	7900 (3583)
	3.73	15100 (6849)	9400 (4264)
5.4L	3.31	14000 (6350)	8300 (3765)
	3.55	15400 (6985)	9700 (4400)
	3.73	15400 (6985) 17100 (7756)*	9700 (4400) 11200 (5080)*

*Maximum GCWR and trailer weight when equipped with Max Trailer Tow package.

SuperCab 4x2 (163" wheelbase)			
Engine	Rear axle ratio	Maximum GCWR-kg (lb.)	Maximum trailer weight-kg (lb.)
5.4L (Heavy Duty)	3.73	17100 (7756)	11300 (5126)

SuperCab 4x4 (163" wheelbase)			
Engine	Rear axle ratio	Maximum GCWR-lb. (kg)	Maximum trailer weight-lb. (kg)
5.4L (Heavy Duty)	3.73	17100 (7756)	11100 (5035)

SuperCrew 4x2 (145" wheelbase)			
Engine	Rear axle ratio	Maximum GCWR-lb. (kg)	Maximum trailer weight-lb. (kg)
4.6L 2V	3.55	10600 (4808)	5200 (2359)
	3.73	11100 (5035)	5700 (2585)

Tires, Wheels and Loading

SuperCrew 4x2 (145" wheelbase)			
Engine	Rear axle ratio	Maximum GCWR-lb. (kg)	Maximum trailer weight-lb. (kg)
4.6L 3V	3.31	13500 (6123)	8100 (3674)
	3.55	14900 (6759)	9500 (4309)
	3.15	13000 (5897)	7500 (3402)
5.4L	3.15	14000 (6350)	8500 (3856)
	3.55	15300 (6940)	9800 (4445)
	3.73	16900 (7666)	11300 (5126)

SuperCrew 4x4 (145" wheelbase)			
Engine	Rear axle ratio	Maximum GCWR-lb. (kg)	Maximum trailer weight-lb. (kg)
4.6L 3V	3.55	13500 (6123)	7700 (3493)
	3.73	15100 (6849)	9300 (4218)
5.4L	3.31	14000 (6350)	8200 (3719)
	3.55	15500 (7031)	9700 (4400)
	3.73	15500 (7031) 17100 (7756)*	9700 (4400) 11200 (5080)*

*Maximum GCWR and trailer weight when equipped with Max Trailer Tow package.

SuperCrew 4x2 (157" wheelbase)			
Engine	Rear axle ratio	Maximum GCWR-lb. (kg)	Maximum trailer weight-lb. (kg)
4.6L 2V	3.55	10600 (4808)	5100 (2313)
	3.73	11100 (5035)	5600 (2540)
4.6L 3V	3.31	13500 (6123)	8000 (3629)
	3.55	14900 (6759)	9300 (4218)
5.4L	3.15	14000 (6350)	8400 (3810)
	3.55	15300 (6940)	9700 (4400)

Tires, Wheels and Loading

SuperCrew 4x4 (157" wheelbase)			
Engine	Rear axle ratio	Maximum GCWR-lb. (kg)	Maximum trailer weight-lb. (kg)
4.6L 3V	3.55	13500 (6123)	7600 (3448)
	3.73	15100 (6849)	9200 (4173)
5.4L	3.31	14000 (6350)	8100 (3674)
	3.55	15500 (7031)	9600 (4354)
	3.73	15500 (7031) 17100 (7756)*	9600 (4354) 11100 (5035)*

*Maximum GCWR and trailer weight when equipped with Max Trailer Tow package.

Trailer frontal area considerations:

- Not to exceed towing vehicle frontal area 36 square feet (3.4 square meters) without the Class IV trailer towing package.
- Not to exceed 60 square feet (5.52 square meters) with the Class IV trailer towing package—excluding vehicles with 3.15 rear axle ratio.
- Not to exceed 45 square feet (4.18 square meters) with the Class IV trailer towing package for vehicles with 3.15 rear axle ratio only.

Note: Do not exceed trailer weight of 5,000 lb. (2,268 kg) when towing with bumper only.

Preparing to tow

Use the proper equipment for towing a trailer and make sure it is properly attached to your vehicle. Contact your authorized dealer or a reliable trailer dealer as soon as possible if you require assistance.

Hitches

Do not use hitches that clamp onto the vehicle's bumper or attach to the axle. You must distribute the load in your trailer so that 10%–15% of the total weight of the trailer is on the tongue.

Weight distributing hitch

When hooking up a trailer using a load equalizing hitch, always use the following procedure:

1. Park the unloaded vehicle on a level surface. With the ignition on and all doors closed, allow the vehicle to stand for several minutes so that it can level.

Tires, Wheels and Loading

2. Measure the height of a reference point on the front and rear bumpers at the center of the vehicle.
3. Attach the trailer to the vehicle and adjust the hitch equalizers so that the front bumper height is within ½ inch (13 mm) of the reference point. After proper adjustment, the rear bumper should be no higher than in Step 2.



WARNING: Do not adjust a weight distributing hitch to any position where the rear bumper of the vehicle is higher than it was before attaching the trailer. Doing so will defeat the function of the weight distributing hitch, which may cause unpredictable handling, and could result in serious personal injury.

Safety chains

Always connect the trailer's safety chains to the frame or hook retainers of the vehicle hitch. To connect the trailer's safety chains, cross the chains under the trailer tongue and allow slack for turning corners.

If you use a rental trailer, follow the instructions that the rental agency gives to you.

Do not attach safety chains to the bumper.

Trailer brakes

Electric brakes and manual, automatic or surge-type trailer brakes are safe if installed properly and adjusted to the manufacturer's specifications. The trailer brakes must meet local and Federal regulations.



WARNING: Do not connect a trailer's hydraulic brake system directly to your vehicle's brake system. Your vehicle may not have enough braking power and your chances of having a collision greatly increase.

The braking system of the tow vehicle is rated for operation at the GVWR not GCWR.

Integrated trailer brake controller (if equipped)

Your vehicle may be equipped with a fully integrated electronic trailer brake controller (TBC). When used properly, the TBC helps ensure smooth and effective trailer braking by powering the trailer's electric brakes with a proportional output based on the towing vehicle's brake pressure.

Tires, Wheels and Loading

WARNING: The Ford TBC has only been verified to be compatible with trailers having electric-actuated drum brakes (one to four axles) and not hydraulic surge or electric-over-hydraulic types. It is the responsibility of the customer to ensure that the trailer brakes are adjusted appropriately, functioning normally and all electric connections are properly made.

The TBC user interface consists of the following:

1. **OUTPUT bar graph:** When the vehicle's brake pedal is pushed, or when the manual control is activated, blue bar indicators will illuminate to indicate the amount of power going to the trailer brakes relative to the brake pedal or manual control input.

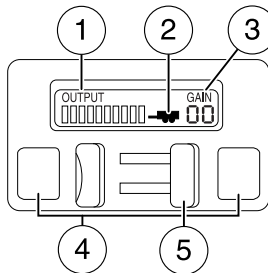

2. **Trailer connection indicator:** This lamp indicates trailer electrical connection status.

- When a successful trailer connection is detected, the indicator will be blue. The display does not flash or turn off when a trailer is connected.
- If the electrical connection is lost, the indicator will flash. If the connection is lost while the vehicle is stationary, the indicator will turn off 30 seconds after releasing the manual control and gain buttons. Sliding the manual control or pressing the gain buttons while the display is off will activate the flashing display for another 30 seconds after releasing the manual control and gain buttons. If the connection is lost while the vehicle is moving, the indicator will flash until the ignition is turned off, or until the connection is reestablished. While disconnected the manual control will not show any output bars.
- If no electrical connection is detected after the ignition is turned on, pressing a GAIN adjustment button will display the GAIN setting for five seconds after releasing the button and the trailer indicator will not be displayed. Sliding the manual control will display the GAIN setting, OUTPUT bar graph and the trailer indicator. All display items will be flashing for five seconds after releasing the manual control and the gain buttons (pressing a gain button while the display is flashing will prolong the flashing until five seconds after releasing the gain button).

Tires, Wheels and Loading

3. **GAIN setting display:** Shows the current GAIN setting. This will illuminate when a trailer is connected, flash if the trailer becomes disconnected, or remain off if no trailer is connected.
4. **+/- (GAIN adjustment buttons):** Pressing these buttons will adjust the TBC's power output to the trailer brakes (in 0.5 increments). The GAIN setting can be increased to a maximum of 10.0 or decreased to a minimum of 0 (no trailer braking). Pressing and holding a button will raise or lower the setting continuously. Continued pressing of a gain button for five seconds after reaching a limit will reset the gain to the previous setting.
5. **Manual control lever:** Slide the control lever to the left to activate power to the trailer's electric brakes independent of the tow vehicle's brakes (see *Procedure for adjusting GAIN* section following for instructions on proper use of this feature). If the manual control is activated while the brake is also applied, the greater of the two inputs determines the power sent to the trailer brakes.
 - **Stop Lamps:** Activating the TBC manual control lever will illuminate both the trailer brake lamps and the tow vehicle brake lamps except the Center High-Mount Stop Lamp (presuming proper trailer electrical connection). Pressing the vehicle brake pedal will also illuminate both trailer and vehicle brake lamps.

GAIN:

The GAIN setting is used to set the TBC for the specific towing condition and should be changed as towing conditions change. Changes to towing conditions include trailer load, vehicle load, road conditions and weather.

The GAIN should be set to provide the maximum trailer braking assistance while ensuring the trailer wheels do not lock when braking. Locked trailer wheels may lead to trailer instability.

Procedure for adjusting GAIN:

Note: This should only be performed in a traffic free environment at speeds of approximately 20–25 mph (30–40 km/h).

1. Make sure the trailer brakes are in good working condition, functioning normally, and properly adjusted. See your trailer dealer if necessary.
2. Hook up the trailer and make the electrical connections according to the trailer manufacturer's instructions.
3. When a trailer with electric brakes is plugged in, the trailer connection indicator will illuminate blue on the TBC and the GAIN setting display will illuminate.

Tires, Wheels and Loading

4. Use the GAIN adjustment (+/-) buttons to increase or decrease the GAIN setting to the desired starting point. A GAIN setting of 6.0 is a good starting point for heavier loads.
5. In a traffic-free environment, tow the trailer on a dry, level surface at a speed of 20–25 mph (30–40 km/h) and squeeze the manual control lever completely.
6. If the trailer wheels lockup (indicated by squealing tires), reduce the GAIN setting; if the trailer wheels turn freely, increase the GAIN setting.

Repeat Steps 5 and 6 until the GAIN setting is at a point just below trailer-wheel lockup. If towing a heavier trailer, trailer wheel lockup may not be attainable even with the maximum GAIN setting of 10.

Explanation of instrument cluster messages:

The TBC interacts with the instrument cluster message center. These messages, accompanied by a single chime, will be displayed when the TBC determines a malfunction in the trailer connection, TBC system, or in the trailer. These messages are listed below:

TRAILER DISCONNECTED: This message is displayed when a trailer connection was determined and then a disconnection, either intentionally or unintentionally, has been sensed during a given ignition cycle. It is also displayed if a trailer fault occurs causing the trailer to appear disconnected. This message is also displayed during manual activation without a trailer connected.

TRAILER BRAKE MODULE FAULT: This message is displayed in response to faults sensed by the TBC. In the event this message is seen, please take your vehicle to an authorized dealer for diagnosis and repair. The TBC may still function, but performance may be degraded.

WIRING FAULT ON TRAILER: The TBC is capable of determining certain faults in the vehicle wiring and trailer wiring/brake system. These faults do not mean there is anything wrong with the TBC. This message is displayed when one of the following faults has occurred:

- *Short circuit on the electric brake output wire:* If the **WIRING FAULT ON TRAILER** message is displayed with no trailer connected, the problem is with the vehicle wiring from the TBC to the 7-pin connector in the bumper. If the message is only displayed with a trailer connected, the problem is related to the trailer wiring; consult your trailer dealer for assistance. This can be a short to ground (i.e., chaffed wire) or a short to voltage (i.e., a pulled pin on trailer emergency break-away battery) or trailer brakes drawing too much current.

Tires, Wheels and Loading

Note: Your TBC can be diagnosed by your authorized dealer to determine exactly which trailer fault has occurred; however, if the fault is with the trailer this diagnosis is **not** covered under your Ford warranty.

Points to Remember:

- Remember to adjust gain setting before using the TBC for the first time.
- Readjust GAIN setting on the TBC (according to procedure above) whenever road, weather and trailer or vehicle loading conditions change from those that existed when the gain was initially set.
- The sliding lever on the TBC should be used only for manual activation of trailer brakes to assist with proper adjustment of the GAIN. Misuse, such as application during trailer sway, could cause instability of trailer and/or tow vehicle.
- Avoid towing in adverse weather conditions. The TBC does not provide anti-lock control of the trailer wheels. Trailer wheels can lockup on slippery surfaces, resulting in reduced stability of trailer and tow vehicle.
- The TBC interacts with the brake system of the vehicle, including ABS, in order to reduce the likelihood of trailer wheel lockup. Therefore, if these systems are not functioning properly the TBC may not function at full performance.
- When the vehicle is turned off, the TBC Output is disabled and the display is shut down. Reactivation of the ignition from off to on will awaken the TBC module.
- The TBC is only a factory or dealer installed item. Ford is not responsible for warranty or performance of the TBC due to misuse or customer installation.
- **Do not attempt removal of the TBC without consulting the *Workshop Manual*. Damage to the unit may result.**

Trailer lamps

Trailer lamps are required on most towed vehicles. Make sure all running lights, brake lights, turn signals and hazard lights are working. Contact your authorized dealer or trailer rental agency for proper instructions and equipment for hooking up trailer lamps.

Using a step bumper (if equipped)

The rear bumper is equipped with an integral hitch and only requires a ball with a one inch (25.4 mm) shank diameter. The bumper has a 5,000 lb (2,270 kg) trailer weight and 500 lb (227 kg) tongue weight capacity.

Tires, Wheels and Loading

If it is necessary to relocate the trailer hitch ball position, a frame-mounted trailer hitch must be installed.

Driving while you tow

When towing a trailer:

- To ensure proper “break-in” of powertrain components, do not trailer tow during the first 1,000 miles (1,600 km) of a new vehicle.
- To ensure proper “break-in” of powertrain components during the first 500 miles (800 km) of trailer towing, drive no faster than 70 mph (113 km/h) with no full throttle starts.
- Turn off the speed control. The speed control may shut off automatically when you are towing on long, steep grades.
- Consult your local motor vehicle speed regulations for towing a trailer.
- To eliminate excessive shifting, use a lower gear. This will also assist in transmission cooling. For additional information, refer to *Automatic transmission operation* in the *Driving* chapter.
- Anticipate stops and brake gradually.
- Do not exceed the GCWR rating or transmission damage may occur.

Servicing after towing

If you tow a trailer for long distances, your vehicle will require more frequent service intervals. Refer to your *scheduled maintenance information* for more information.

Trailer towing tips

- Practice turning, stopping and backing up before starting on a trip to get the feel of the vehicle trailer combination. When turning, make wider turns so the trailer wheels will clear curbs and other obstacles.
- Allow more distance for stopping with a trailer attached.
- If you are driving down a long or steep hill, shift to a lower gear. Do not apply the brakes continuously, as they may overheat and become less effective. Also, see the information on tow/haul mode operation under *Automatic transmission operation* in the *Driving* chapter.
- The trailer tongue weight should be 10–15% of the loaded trailer weight.

Tires, Wheels and Loading

- If you will be towing a trailer frequently in hot weather, hilly conditions, at GCWR, or any combination of these factors, consider refilling your rear axle with synthetic gear lube if not already so equipped. Refer to the *Maintenance and Specifications* chapter for the lubricant specification. Remember that regardless of the rear axle lube used, do not tow a trailer for the first 1,000 miles (1,600 km) of a new vehicle, and that the first 500 miles (800 km) of towing be done at no faster than 70 mph (113 km/h) with no full throttle starts.
- After you have traveled 50 miles (80 km), thoroughly check your hitch, electrical connections and trailer wheel lug nuts.
- To aid in engine/transmission cooling and A/C efficiency during hot weather while stopped in traffic, place the gearshift lever in P (Park).
- Vehicles with trailers should not be parked on a grade. If you must park on a grade, place wheel chocks under the trailer's wheels.

Launching or retrieving a boat

Disconnect the wiring to the trailer before backing the trailer into the water. Reconnect the wiring to the trailer after the trailer is removed from the water.

When backing down a ramp during boat launching or retrieval:

- do not allow the static water level to rise above the bottom edge of the rear bumper.
- do not allow waves to break higher than 6 inches (15 cm) above the bottom edge of the rear bumper.

Exceeding these limits may allow water to enter vehicle components:

- causing internal damage to the components.
- affecting driveability, emissions and reliability.

Replace the rear axle lubricant any time the axle has been submerged in water. Rear axle lubricant quantities are not to be checked or changed unless a leak is suspected or repair required.

RECREATIONAL TOWING

Follow these guidelines if you have a need for recreational (RV) towing. An example of recreational towing would be towing your vehicle behind a motorhome. These guidelines are designed to ensure that your transmission is not damaged.

Note: Put your climate control system in recirculated air mode to prevent exhaust fumes from entering the vehicle. Refer to the *Climate controls* chapter for more information.

Tires, Wheels and Loading

2WD vehicles: Do not tow your vehicle with any wheels on the ground, as vehicle or transmission damage may occur. It is recommended to tow your vehicle with all four (4) wheels off the ground such as when using a car-hauling trailer. Otherwise, no recreational towing is permitted.

4WD vehicles equipped with manual-shift transfer case:

- Release the parking brake.
- Turn the key in the ignition to the off position.
- Place the transmission in N (Neutral).
- Place the transfer case lever in N (Neutral).
- The maximum recommended distance is unlimited.
- The vehicle must be towed in the forward position to ensure no damage is done to the internal transfer case components.

The transfer case N (Neutral) position overrides the transmission and puts the vehicle in neutral regardless of transmission gearshift lever position. The vehicle can move forward or backward. This position should only be used when towing the vehicle.



WARNING: Do not leave the vehicle unattended with the transfer case in the N (Neutral) position. Always set the parking brake fully and turn off the ignition when leaving the vehicle.

After reaching the destination, you must place your vehicle's 4x4 gearshift lever in gear (2H, 4H or 4L).

In case of a roadside emergency with a disabled vehicle, see *Wrecker towing* in the *Roadside Emergencies* chapter.

4WD vehicles equipped with an electronic-shift transfer case: Do not tow your vehicle with any wheels on the ground, as vehicle or transmission damage may occur. It is recommended to tow your vehicle with all four (4) wheels off the ground such as when using a car-hauling trailer. Otherwise, no recreational towing is permitted.

In case of a roadside emergency with a disabled vehicle, see *Wrecker towing* in the *Roadside Emergencies* chapter.

STARTING

Positions of the ignition

1. Off — locks the automatic transmission gearshift lever and allows key removal.

Note: The ignition key cannot be removed from the ignition unless the gearshift lever is securely latched in P (Park).

2. Accessory — allows the electrical accessories such as the radio to operate while the engine is not running.

3. On — all electrical circuits operational. Warning lights illuminated. Key position when driving.

4. Start — cranks the engine. Release the key as soon as the engine starts.

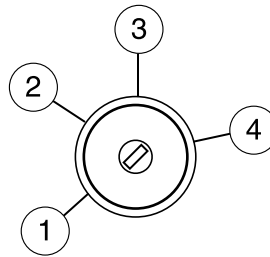

Preparing to start your vehicle

Engine starting is controlled by the powertrain control system.

This system meets all Canadian interference-causing equipment standard requirements regulating the impulse electrical field strength of radio noise.

When starting a fuel-injected engine, don't press the accelerator before or during starting. Only use the accelerator when you have difficulty starting the engine. For more information on starting the vehicle, refer to *Starting the engine* in this chapter.



WARNING: Extended idling at high engine speeds can produce very high temperatures in the engine and exhaust system, creating the risk of fire or other damage.



WARNING: Do not park, idle, or drive your vehicle in dry grass or other dry ground cover. The emission system heats up the engine compartment and exhaust system, which can start a fire.

Driving



WARNING: Do not start your vehicle in a closed garage or in other enclosed areas. Exhaust fumes can be toxic. Always open the garage door before you start the engine. See *Guarding against exhaust fumes* in this chapter for more instructions.



WARNING: If you smell exhaust fumes inside your vehicle, have your dealer inspect your vehicle immediately. Do not drive if you smell exhaust fumes.

Important safety precautions

A computer system controls the engine's idle revolutions per minute (RPM). When the engine starts, the idle RPM runs higher than normal in order to warm the engine. If the engine idle speed does not slow down automatically, have the vehicle checked. If the vehicle is operated in a heavy snow storm or blowing snow conditions, the engine air induction may become partially clogged with snow and/or ice. If this occurs the engine may experience a significant reduction in power output. At the earliest opportunity, clear all snow and/or ice away from the air induction inlet. Do not allow the vehicle to idle for more than 10 minutes at the higher engine RPM.

Before starting the vehicle:

1. Make sure all vehicle occupants have buckled their safety belts. For more information on safety belts and their proper usage, refer to the *Seating and Safety Restraints* chapter.
2. Make sure the headlamps and vehicle accessories are off.
3. Make sure the gearshift is in P (Park).

Driving

- 4-speed transmission

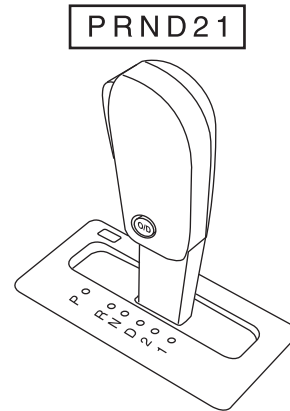

- 6-speed transmission

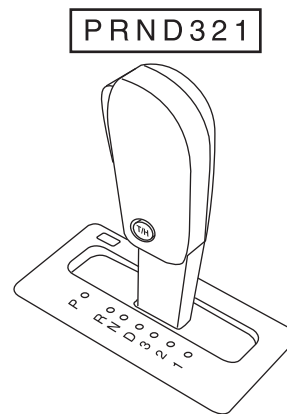

Driving

4. Make sure the parking brake is set.

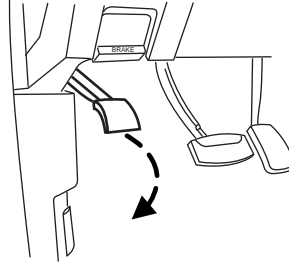

5. Turn the key to 3 (on) without turning the key to 4 (start).

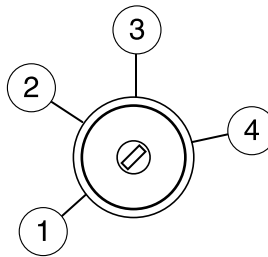

Some warning lights will briefly illuminate. See *Warning lights and chimes* in the *Instrument Cluster* chapter for more information regarding the warning lights.

Starting the engine

1. Turn the key to 3 (on) without turning the key to 4 (start).

2. Turn the key to 4 (start), then release the key as soon as the engine begins cranking. Your vehicle has a computer assisted cranking system that assists in starting the engine. After releasing the key from the 4 (start) position, the engine may continue cranking for up to 10 seconds or until the vehicle starts.

Note: Cranking may be stopped at any time by turning the key to the off position.

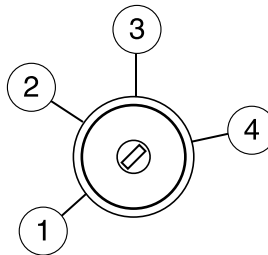

3. After idling for a few seconds, release the parking brake, apply the brake, shift into gear and drive.

Note: If the engine does not start on the first try, turn the key to the off position, wait 10 seconds and try Step 2 again. If the engine still fails to start, press the accelerator to the floor and try Step 2 again, keeping the accelerator on the floor until the engine begins to accelerate above cranking speeds; this will allow the engine to crank with the fuel shut off in case the engine is flooded with fuel.

Cold weather starting (flexible fuel vehicles only)

The starting characteristics of all grades of E₈₅ ethanol make it unsuitable for use when ambient temperatures fall below 0°F (-18°C). Consult your fuel distributor for the availability of winter grade ethanol. As the outside temperature approaches freezing, ethanol fuel distributors should supply winter grade ethanol (same as with unleaded gasoline). If summer grade ethanol is used in cold weather conditions, 0°F to 32°F (-18°C to 0°C), you may experience increased cranking times, rough idle or hesitation until the engine has warmed up.

You may experience a decrease in peak performance when the engine is cold when operating on E₈₅ ethanol.

Do not crank the engine for more than 10 seconds at a time as starter damage may occur. If the engine fails to start, turn the key to off and wait 30 seconds before trying again.

Do not use starting fluid such as ether in the air intake system. Such fluid could cause immediate explosive damage to the engine and possible personal injury.

If you should experience cold weather starting problems on E₈₅ ethanol, and neither an alternative brand of E₈₅ ethanol nor an engine block heater is available, the addition of unleaded gasoline to your tank will improve cold starting performance. Your vehicle is designed to operate on E₈₅ ethanol alone, unleaded gasoline alone, or any mixture of the two.

See *Choosing the right fuel* in the *Maintenance and Specifications* chapter for more information on ethanol.

If the engine fails to start using the preceding instructions (flexible fuel vehicles only)

1. Press and hold down the accelerator 1/3 to 1/2 way to floor, then crank the engine.
2. When the engine starts, release the key, then gradually release the accelerator pedal as the engine speeds up. If the engine still fails to start, repeat Step 1.

Driving

Guarding against exhaust fumes

Carbon monoxide is present in exhaust fumes. Take precautions to avoid its dangerous effects.



WARNING: If you smell exhaust fumes inside your vehicle, have your dealer inspect your vehicle immediately. Do not drive if you smell exhaust fumes.

Important ventilating information

If the engine is idling while the vehicle is stopped for a long period of time, open the windows at least one inch (2.5 cm) or adjust the heating or air conditioning to bring in fresh air.

ENGINE BLOCK HEATER (IF EQUIPPED)

An engine block heater warms the engine coolant which aids in starting and allows the heater/defroster system to respond quickly. If your vehicle is equipped with this system, your equipment includes a heater element which is installed in your engine block and a wire harness which allows the user to connect the system to a grounded 120 volt a/c electrical source. The block heater system is most effective when outdoor temperatures reach below 0°F (-18°C).

For flexible fuel vehicles, if operating with E₈₅ ethanol, an engine block heater must be used if ambient temperature is below 0°F (-18°C).

See *Cold weather starting* in the *Driving* chapter for more information on starting with ethanol.



WARNING: Failure to follow engine block heater instructions could result in property damage or physical injury.



WARNING: To reduce the risk of electrical shock, do not use your heater with ungrounded electrical systems or two-pronged (cheater) adapters.

Prior to using the engine block heater, follow these recommendations for proper and safe operation:

- For your safety, use an outdoor extension cord that is product certified by Underwriter's Laboratory (UL) or Canadian Standards Association (CSA). Use only an extension cord that can be used outdoors, in cold temperatures, and is clearly marked "Suitable for Use with Outdoor Appliances." Never use an indoor extension cord outdoors; it could result in an electric shock or fire hazard.
- Use a 16 gauge outdoor extension cord, minimum.
- Use as short an extension cord as possible.
- Do not use multiple extension cords. Instead, use one extension cord which is long enough to reach from the engine block heater cord to the outlet without stretching.
- Make certain that the extension cord is in excellent condition (not patched or spliced). Store your extension cord indoors at temperatures above 32°F (0°C). Outdoor conditions can deteriorate extension cords over a period of time.
- To reduce the risk of electrical shock, do not use your heater with ungrounded electrical systems or two pronged (cheater) adapters. Also ensure that the block heater, especially the cord, is in good condition before use.
- Make sure that when in operation, the extension cord plug /engine block heater cord plug connection is free and clear of water in order to prevent possible shock or fire.
- Be sure that areas where the vehicle is parked are clean and clear of all combustibles such as petroleum products, dust, rags, paper and similar items.
- Be sure that the engine block heater, heater cord and extension cord are solidly connected. A poor connection can cause the cord to become very hot and may result in an electrical shock or fire. Be sure to check for heat anywhere in the electrical hookup once the system has been operating for approximately a half hour.
- Finally, have the engine block heater system checked during your fall tune-up to be sure it's in good working order.

How to use the engine block heater

Ensure the receptacle terminals are clean and dry prior to use. To clean them, use a dry cloth.

Driving

Depending on the type of factory installed equipment, your engine block heater system may consume anywhere between 400 watts or 1000 watts of power per hour. Your factory installed block heater system does not have a thermostat; however, maximum temperature is attained after approximately three hours of operation. Block heater operation longer than 3 hours will not improve system performance and will unnecessarily use additional electricity.

Make sure system is unplugged and properly stowed before driving the vehicle. While not in use, make sure the protective cover seals the prongs of the engine block heater cord plug.

BRAKES

Occasional brake noise is normal. If a metal-to-metal, continuous grinding or continuous squeal sound is present, the brake linings may be worn-out and should be inspected by an authorized dealer. If the vehicle has continuous vibration or shudder in the steering wheel while braking, the vehicle should be inspected by an authorized dealer.

Refer to *Brake system warning light* in the *Instrument Cluster* chapter for information on the brake system warning light.



Four-wheel anti-lock brake system (ABS)

Your vehicle is equipped with an Anti-lock Braking System (ABS). This system helps you maintain steering control during emergency stops by keeping the brakes from locking. Noise from the ABS pump motor and brake pedal pulsation may be observed during ABS braking and the brake pedal may suddenly travel a little farther as soon as ABS braking is done and normal brake operation resumes. These are normal characteristics of the ABS and should be no reason for concern.

Using ABS

When hard braking is required, apply continuous force on the brake pedal; do not pump the brake pedal since this will reduce the effectiveness of the ABS and will increase your vehicle's stopping distance. The ABS will be activated immediately, allowing you to retain steering control during hard braking and on slippery surfaces. However, the ABS does not decrease stopping distance.

ABS warning lamp

The ABS lamp in the instrument cluster momentarily illuminates when the ignition is turned on. If the light does not illuminate during start up, remains on or flashes, the ABS may be disabled and may need to be serviced.



Even when the ABS is disabled, normal braking is still effective. If your BRAKE warning lamp illuminates with the parking brake released, have your brake system serviced immediately.



Parking brake

To set the parking brake (1), press the parking brake pedal down until the pedal stops.

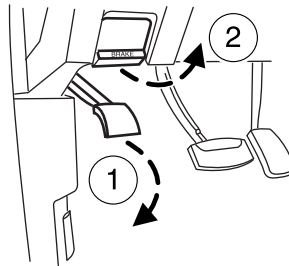

The BRAKE warning lamp will illuminate and will remain illuminated until the parking brake is released.



To release, pull the lever (2).







WARNING: Always set the parking brake fully and make sure that the gearshift is securely latched in P (Park) (automatic transmission) or in 1 (First) (manual transmission).

Driving

ADVANCETRAC® WITH ROLL STABILITY CONTROL™ (RSC®) STABILITY ENHANCEMENT SYSTEM

 **WARNING:** Vehicle modifications involving braking system, aftermarket roof racks, suspension, steering system, tire construction and/or wheel/tire size may change the handling characteristics of the vehicle and may adversely affect the performance of the AdvanceTrac® with RSC system. In addition, installing any stereo loudspeakers may interfere with and adversely affect the AdvanceTrac® with RSC® system. Install any aftermarket stereo loudspeaker as far as possible from the front center console, the tunnel, and the front seats in order to minimize the risk of interfering with the AdvanceTrac® with RSC® sensors. Reducing the effectiveness of the AdvanceTrac® with RSC® system could lead to an increased risk of loss of vehicle control, vehicle rollover, personal injury and death.

 **WARNING:** Remember that even advanced technology cannot defy the laws of physics. It's always possible to lose control of a vehicle due to inappropriate driver input for the conditions. Aggressive driving on any road condition can cause you to lose control of your vehicle increasing the risk of personal injury or property damage. Activation of the AdvanceTrac® with RSC® system is an indication that at least some of the tires have exceeded their ability to grip the road; this could reduce the operator's ability to control the vehicle, potentially resulting in a loss of vehicle control, vehicle rollover, personal injury and death. If your AdvanceTrac® with RSC® system activates, SLOW DOWN.



 **WARNING:** If a failure has been detected within the AdvanceTrac® with RSC® system, the "sliding car" icon  will illuminate steadily. Verify that the AdvanceTrac® with RSC® system is not manually disabled (push the AdvanceTrac® with RSC® "Off" control button located on the center of the instrument panel). If the "sliding car" icon  still illuminates steadily, have the system service by an authorized dealer immediately. Operating your vehicle with AdvanceTrac® with RSC® disabled could lead to an increased risk of loss of vehicle control, vehicle rollover, personal injury and death.

Driving



The AdvanceTrac® with RSC® system provides the following stability enhancement features for certain driving situations:

- Traction Control (TCS), which functions to help avoid drive-wheel spin and loss of traction.
- Electronic Stability Control (ESC), which functions to help avoid skids or lateral slides
- Roll Stability Control™ (RSC®), which functions to help avoid a vehicle roll-over.

The AdvanceTrac® with RSC® system automatically enables each time the engine is started. All features of the AdvanceTrac® with RSC® system (TCS, ESC, and RSC®) are active and monitor the vehicle from start-up. However, the system will only intervene if the driving situation requires it.

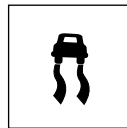
The AdvanceTrac® with RSC® system includes an AdvanceTrac® with RSC® "Off" control button on the center of the instrument panel, and a "sliding car" icon  in the instrument cluster. The "sliding car" icon 



in the instrument cluster will illuminate if a driving situation causes the AdvanceTrac® with RSC® system to operate. If the "sliding car" icon  illuminates steadily, verify that the AdvanceTrac® with RSC® system is not manually disabled by pressing the AdvanceTrac® with RSC® "Off" button located on the center stack of the instrument panel. If the "sliding car" icon  remains steadily illuminated, have the system serviced by an authorized dealer immediately.

When AdvanceTrac® with RSC® performs a normal system self-check, some drivers may notice a slight movement of the brake, and/or a rumble, grunting, or grinding noise after startup and when driving off.

When an event occurs that activates AdvanceTrac® with RSC® you may experience the following:

- A slight deceleration of the vehicle
- The "sliding car"  indicator light will flash.
- A vibration in the pedal when your foot is on the brake pedal
- If the driving condition is severe and your foot is not on the brake, the brake pedal may move as the systems applies higher brake forces. You may also hear a whoosh of air from under the instrument panel during this severe condition.

Driving

- The brake pedal may feel stiffer than usual.

Traction Control (TCS)

Traction Control is a driver aid feature that helps your vehicle maintain traction of the wheels, typically when driving on slippery and/or hilly road surfaces, by detecting and controlling wheel spin.

Excessive wheel spin is controlled in two ways, which may work separately or in tandem: Engine Traction Control and Brake Traction Control. Engine Traction Control works to limit drive-wheel spin by momentarily reducing engine power. Brake Traction Control works to limit wheel spin by momentarily applying the brakes to the wheel that is slipping. Traction Control is most active at low speeds.

During Traction Control events the “sliding car” icon  in the instrument cluster will flash.

If the Traction Control system is activated excessively in a short period of time, the braking portion of the system may become temporarily disabled to allow the brakes to cool down. In this situation, Traction Control will use only engine power reduction or transfer to help control the wheels from over-spinning. When the brakes have cooled down, the system will regain all features. Anti-lock braking, RSC[®], and ESC are not affected by this condition and will continue to function during the cool-down period.

The Engine Traction Control and Brake Traction Control system may be deactivated in certain situations. See the *Switching Off AdvanceTrac[®] with RSC[®]* section following.

Electronic Stability Control (ESC)

Electronic Stability Control (ESC) may enhance your vehicle’s directional stability during adverse maneuvers, for example when cornering severely or avoiding objects in the roadway. ESC operates by applying brakes to one or more of the wheels individually and, if necessary, reducing engine power if the system detects that the vehicle is about to skid or slide laterally.

During Electronic Stability Control events the “sliding car” icon  in the instrument cluster will flash.

Certain adverse driving maneuvers may activate the Electronic Stability Control system, which include but are not limited to:

- Taking a turn too fast
- Maneuvering quickly to avoid an accident, pedestrian or obstacle
- Driving over a patch of ice or other slippery surfaces

- Changing lanes on a snow-rutted road
- Entering a snow-free road from a snow-covered side street, or vice versa
- Entering a paved road from a gravel road, or vice versa
- Cornering while towing a heavily loaded trailer (refer to *Trailer towing* in the *Tires, Wheels and Loading* chapter).

The Electronic Stability Control system may be deactivated in certain situations. See the *Switching Off AdvanceTrac® with RSC®* section following.

Roll Stability Control™ (RSC®)

Roll Stability Control (RSC®) may help to maintain roll stability of the vehicle during adverse maneuvers. RSC® operates by detecting the vehicle's roll motion and the rate at which it changes and by applying the brakes to one or more wheels individually.

During an event that activates the Roll Stability Control™ (RSC®) the "sliding car" icon  in the instrument cluster will flash.



Certain adverse driving maneuvers may activate the Roll Stability Control system, which include:

- Emergency lane-change
- Taking a turn too fast
- Quick maneuvering to avoid an accident, pedestrian or obstacle

The Roll Stability Control system may be deactivated in certain situations. See the *Switching Off AdvanceTrac® with RSC®* section following.

Switching Off AdvanceTrac® with RSC®

If the vehicle is stuck in snow, mud or sand, and seems to lose engine power, switching off certain features of the AdvanceTrac® with RSC® system may be beneficial because the wheels are allowed to spin. This will restore full engine power and will enhance momentum through the obstacle. To switch off the AdvanceTrac® with RSC® system press the AdvanceTrac® with RSC® "Off" button. Full features of the AdvanceTrac® with RSC® system can be restored by pressing the AdvanceTrac® with RSC® "Off" button again or by turning off and restarting the engine.

If you switch off the AdvanceTrac® with RSC® system, the sliding car" icon  will illuminate steadily. Pressing the AdvanceTrac® with RSC® "Off" button again will turn off the "sliding car" icon .

Driving

In R (Reverse), ABS and the Engine and Brake Traction Control features will continue to function; however, ESC and RSC® are disabled.

AdvanceTrac® with RSC® Features				
Button functions	“Sliding car” icon 	RSC®	ESC	Traction Control
Default at start-up	Illuminated during bulb check	Enabled	Enabled	Enabled
Button pressed momentarily	Illuminated during bulb check	Enabled	Enabled	Disabled
Button pressed and held for more than five seconds at vehicle speed under 35 mph (56 km/h)	Flashes then illuminated solid	Disabled	Disabled	Disabled
Vehicle speed exceeds 35 mph (56 km/h) after button is pressed and held for more than five seconds	Illuminated solid	Enabled	Enabled	Disabled
Button pressed again after deactivation	Not illuminated	Enabled	Enabled	Enabled

Trailer Sway Control

Your vehicle may be equipped with trailer sway control. When properly equipped, trailer sway control will use the vehicle's AdvanceTrac® with RSC® system to detect and help reduce trailer sway by applying brake force at individual wheels and, if necessary, by reducing engine power.

Driving



WARNING: Trailer sway control does not prevent a trailer from swaying, it mitigates the sway from increasing once it has occurred. If you are experiencing trailer sway it is likely that the trailer is improperly loaded for the correct tongue weight or the speed of the vehicle and trailer is too high. Pull the vehicle-trailer over to a safe location to check the trailer weight distribution and tongue load and reduce speed to a safe level while towing. If trailer sway is experienced, SLOW DOWN.

During Trailer Sway Control events the "skidding car"  icon in the instrument cluster will flash momentarily. The message center will also display **TRAILER SWAY REDUCE SPEED**. In some cases when trailer sway is detected, the vehicle speed is too high and may be above a speed at which trailer sway will not grow continuously. This may cause the system to activate multiple times, causing a gradual reduction in speed.

Note: The trailer sway control will only activate at speeds greater than 40 mph (64 km/h).

Disabling Trailer Sway Control

Trailer sway control can be disabled during any key cycle. See Trailer Sway Control under the *Message center* in the *Driver Controls* chapter. Note that regardless of chosen enable state, Trailer Sway Control will be re-enabled at each new key cycle.



WARNING: Turning off Trailer Sway Control increases the risk of loss of vehicle control, serious injury, or death. Ford does not recommend disabling this feature except in situations where speed reduction may be detrimental (e.g., hill climbing), the driver has significant trailer towing experience, and can control trailer sway and maintain safe operation.

STEERING

To help prevent damage to the power steering system:

- Never hold the steering wheel at its furthest turning points (until it stops) for more than a few seconds when the engine is running.
- Do not operate the vehicle with a low power steering fluid level (below the MIN mark on the reservoir).
- Some noise is normal during operation. If the noise is excessive, check for a low power steering fluid level before seeking service by your authorized dealer.

Driving

- Heavy or uneven steering efforts may be caused by a low power steering fluid level. Check for a low power steering fluid level before seeking service by your authorized dealer.
- Do not fill the power steering fluid reservoir above the MAX mark on the reservoir.

If the power steering system breaks down (or if the engine is turned off), you can steer the vehicle manually, but it takes more effort.

If the steering wanders or pulls, check for:

- an improperly inflated tire
- uneven tire wear
- loose or worn suspension components
- loose or worn steering components
- improper steering alignment

A high crown in the road or high crosswinds may also make the steering seem to wander/pull.

LIMITED-SLIP AXLE (IF EQUIPPED)

This axle provides added traction on slippery surfaces, particularly when one wheel is on a poor traction surface. Under normal conditions, the Limited-slip axle functions like a standard rear axle. The axle may exhibit a slight noise or vibration in tight turns with low vehicle speed. This is normal behavior and indicates the axle is working.

Electronic locking differential (ELD) axle (if equipped)

This axle provides added traction on slippery and/or off road surfaces, particularly when one wheel is on a poor traction surface. In normal driving conditions the rear axle function as a standard axle. The ELD may be locked or unlocked by the vehicle operator. Refer to *Four-wheel drive (4WD) operation* section in this chapter for further detail on ELD function and usage. When the axle is unlocked it will function like a standard rear axle. When the axle is locked it will not allow the rear wheels to rotate at different speeds when turning. The ELD axle is not recommended for use on good traction surfaces such as dry pavement. Doing so may result in abnormal driving behavior while cornering and excessive tire wear.

Driving

PREPARING TO DRIVE



WARNING: Utility vehicles have a significantly higher rollover rate than other types of vehicles.



WARNING: In a rollover crash, an unbelted person is significantly more likely to die than a person wearing a seat belt.

Utility vehicles and trucks have larger tires and increased ground clearance, giving the vehicle a higher center of gravity than a passenger car.



WARNING: Vehicles with a higher center of gravity such as utility vehicles and trucks handle differently than vehicles with a lower center of gravity. Utility vehicles and trucks are **not** designed for cornering at speeds as high as passenger cars any more than low-slung sports cars are designed to perform satisfactorily under off-road conditions. Avoid sharp turns, excessive speed or abrupt maneuvers in these vehicles. Failure to drive cautiously could result in an increased risk of loss of vehicle control, vehicle rollover, personal injury and death.



WARNING: Loaded vehicles, with a higher center of gravity, may handle differently than unloaded vehicles. Do not overload your vehicle and use extra precautions, such as driving at slower speeds, avoiding abrupt steering changes and allowing for increased stopping distance, when driving a heavily loaded vehicle. Over-loading or loading the vehicle improperly can deteriorate handling capability and contribute to loss of vehicle control and vehicle rollover.

AUTOMATIC TRANSMISSION OPERATION

Brake-shift interlock - column-shift transmission

This vehicle is equipped with a park/brake-shift interlock feature that prevents the gearshift lever from being moved from P (Park) when the ignition is in the on position unless the brake pedal is pressed.

If you cannot move the gearshift lever out of P (Park) with ignition in the on position and the brake pedal pressed, it is possible that a fuse has blown or the vehicle's brakelamps are not operating properly. Refer to *Fuses and relays* in the *Roadside Emergencies* chapter.

Driving

If the fuse is not blown, perform the following procedure:

Note: The following procedure is easier to perform when the steering column is adjusted to the full up position. Refer to *Tilt steering wheel* in the *Driver Controls* chapter.

1. Apply the parking brake, turn the ignition to the off position, then remove the key.

2. Move the shift lever boot by pressing on the edges and moving it up the gearshift lever.

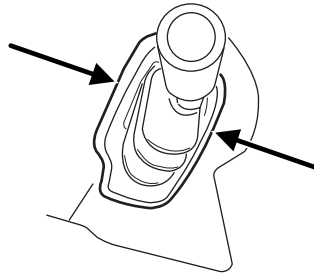

3. Turn the steering wheel one-half turn to access the slots on each side of the steering wheel.

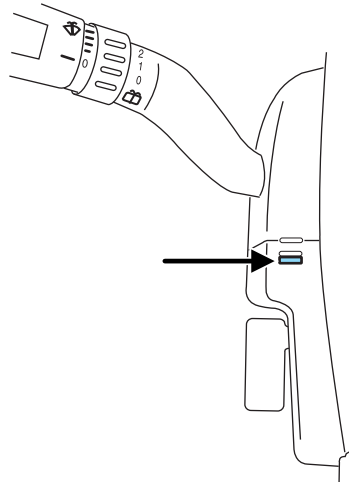

Driving

4. Insert a flat head screwdriver into each slot to unsnap and remove the steering column cover. Rotate the column up on its hinges and pull rearward to remove the cover from the hinges.

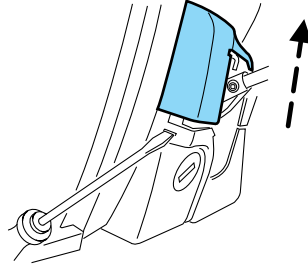

5. With the ignition in the on position, pull back on the BSI solenoid found on top of the uncovered steering column and at the same time, apply the brake pedal and shift the transmission into N (Neutral).

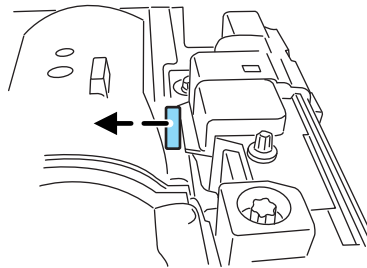

6. Reinstall the steering column cover, start the vehicle and release the parking brake.

Note: After the transmission is shifted to N (Neutral), it is easier to reinstall the cover when the column is in the middle or lower tilt position.



WARNING: Do not drive your vehicle until you verify that the brakelamps are working.



WARNING: Always set the parking brake fully and make sure the gearshift is latched in P (Park). Turn the ignition to the off position and remove the key whenever you leave your vehicle.



WARNING: If the parking brake is fully released, but the brake warning lamp remains illuminated, the brakes may not be working properly. See your authorized dealer.

Driving

Brake-shift interlock – floor-shift transmission

This vehicle is equipped with a brake-shift interlock feature that prevents the gearshift lever from being moved from P (Park) when the ignition is in the ON position unless the brake pedal is pressed.

If you cannot move the gearshift lever out of P (Park) with ignition in the on position and the brake pedal pressed, or when the ignition is in the off position, it is possible that a fuse has blown or the vehicle's brakelamps are not operating properly. Refer to *Fuses and relays* in the *Roadside Emergencies* chapter.

If the fuse is not blown, perform the following procedure:

1. Apply the parking brake, turn the ignition to off, then remove the key.
 2. Using a screwdriver or similar tool, remove the protective cover to the interlock release access hole, located to the right of the gearshift lever.
- 4-speed transmission

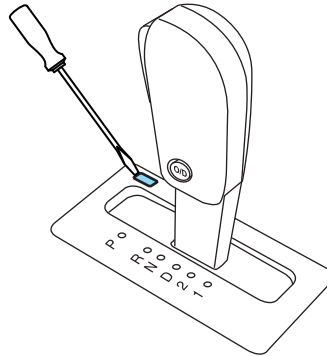

- 6-speed transmission

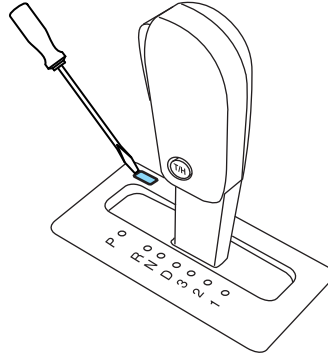

3. Insert a screwdriver or similar tool straight down into the access hole and press downward while pulling the gearshift lever out of the P (Park) position and into the N (Neutral) position.
4. Remove tool and reinstall the protective cover.
5. Start the vehicle and release the parking brake.



WARNING: Do not drive your vehicle until you verify that the brakelamps are working.



WARNING: Always set the parking brake fully and make sure the gearshift is latched in P (Park). Turn the ignition to the off position and remove the key whenever you leave your vehicle.



WARNING: If the parking brake is fully released, but the brake warning lamp remains illuminated, the brakes may not be working properly. See your authorized dealer.

Understanding the gearshift positions of the 4-speed automatic transmission

Your vehicle has been designed to improve fuel economy by reducing fuel usage during coasting or deceleration. When you take your foot off the accelerator pedal and the vehicle begins to slow down the torque converter clutch locks up and aggressively shuts off fuel flow to the engine while decelerating. This fuel economy benefit may be perceived as a light to medium braking sensation when removing your foot from the accelerator pedal.

Driving

Your vehicle's automatic transmission is equipped with a special shift strategy that ensures maximum heater performance during cold weather operation.

When ambient temperature is 23°F (-5°C) or below and the engine coolant temperature is below 100°F (38°C), light throttle upshifts may be slightly delayed. Once the engine coolant temperature reaches 160°F (71°C) the normal shift strategy will resume. This is normal operation and will not affect the function or the durability of the transmission.

If the normal shift strategy does not resume once the engine coolant temperature reaches the normal operating temperature, or if the downshifts and other throttle conditions do not function normally, see your authorized dealer as soon as possible.

P (Park)

This position locks the transmission and prevents the rear wheels from turning.

To put your vehicle in gear:

- Start the engine
- Press the brake pedal
- Move the gearshift lever into the desired gear
- Release the parking brake.

To put your vehicle in P (Park):

- Come to a complete stop
- Move the gearshift lever and securely latch it in P (Park)

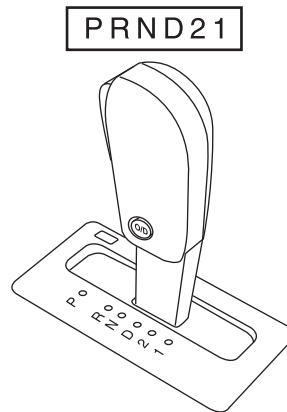

WARNING: Always set the parking brake fully and make sure the gearshift is latched in P (Park). Turn the ignition to the off position and remove the key whenever you leave your vehicle.

R (Reverse)

With the gearshift lever in R (Reverse), the vehicle will move backward. Always come to a complete stop before shifting into and out of R (Reverse).

N (Neutral)

With the gearshift lever in N (Neutral), the vehicle can be started and is free to roll. Hold the brake pedal down while in this position.

D (Overdrive)

The normal driving position for the best fuel economy. Transmission operates in gears one through four.

Overdrive can be deactivated by pressing the transmission control switch on the end of the gearshift lever (column-shift transmission) or on the gearshift bezel (floor-shift transmission).

- Column-shift transmission

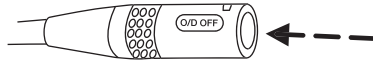

- Floor-shift transmission

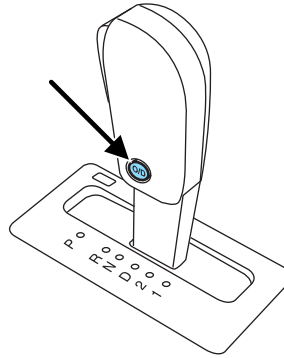

The transmission control indicator (TCIL) will illuminate on the instrument cluster.

**O/D
OFF**

Drive (not shown)

Drive is activated when the transmission control switch is pressed.

- This position allows for all forward gears except overdrive.
- O/D OFF lamp is illuminated.
- Provides engine braking.
- Use when driving conditions cause excessive shifting from O/D to other gears. Examples: heavy city traffic where continuous shifting in

Driving

and out of overdrive occurs, hilly terrain, heavy loads, trailer towing and when engine braking is required.

- To return to O/D (Overdrive), press the transmission control switch. The O/D OFF lamp will not be illuminated.
- O/D (Overdrive) is automatically returned each time the key is turned off.

2 (Second)

This position allows for second gear only.

- Provides engine braking.
- Use to start-up on slippery roads.
- To return to D (Overdrive), move the gearshift lever into the D (Overdrive) position.
- Selecting 2 (Second) at higher speeds will cause the transmission to downshift to second gear at the appropriate vehicle speed.

1 (First)

- Provides maximum engine braking.
- Allows upshifts by moving gearshift lever.
- Will not downshift into 1 (First) at high speeds; allows for 1 (First) when vehicle reaches slower speeds.

Forced downshifts

- Allowed in D (Overdrive) or Drive.
- Press the accelerator to the floor.
- Allows transmission to select an appropriate gear.

Driving with a 6–speed automatic transmission

Your vehicle has been designed to improve fuel economy by reducing fuel usage during coasting or deceleration. When you take your foot off the accelerator pedal and the vehicle begins to slow down the torque converter clutch locks up and aggressively shuts off fuel flow to the engine while decelerating. This fuel economy benefit may be perceived as a light to medium braking sensation when removing your foot from the accelerator pedal.

This vehicle is equipped with an Adaptive Transmission Shift Strategy. The Adaptive Transmission Shift Strategy offers the optimal transmission operation and shift quality. When the engine is turned off, the shift data which includes the adaptive information will be stored automatically in

Driving

the Powertrain Control Module (PCM) and Transmission Control Module (TCM). If the battery is disconnected for any reason, the stored information from the last time the key was turned to off will be read. This way, no information will be lost with any battery removal or battery disconnect.

P (Park)

This position locks the transmission and prevents the rear wheels from turning.

To put your vehicle in gear:

- Press the brake pedal
- Start the engine
- Move the gearshift lever into the desired gear. If your vehicle is equipped with a floor-shift transmission, press the gearshift lever release button (on the front of the lever) while shifting into the desired gear.

To put your vehicle in P (Park):

- Come to a complete stop
- Move the gearshift lever and securely latch it in P (Park)

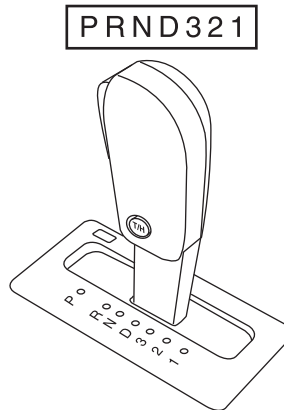

WARNING: Always set the parking brake fully and make sure the gearshift is latched in P (Park). Turn the ignition to the off position and remove the key whenever you leave your vehicle.

R (Reverse)

With the gearshift lever in R (Reverse), the vehicle will move backward. Always come to a complete stop before shifting into and out of R (Reverse).

N (Neutral)

With the gearshift lever in N (Neutral), the vehicle can be started and is free to roll. Hold the brake pedal down while in this position.

D (Overdrive) with Tow/Haul Off

The normal driving position for the best fuel economy. Transmission operates in gears one through six.

Driving

D (Overdrive) with Tow/Haul On

The Tow/Haul feature improves transmission operation when towing a trailer or a heavy load. All transmission gear ranges are available when using Tow/Haul.

Tow/Haul can be activated by pressing the transmission control switch on the end of the gearshift lever (column-shift transmission) or on the side of the gearshift lever (floor-shift transmission).

- Column-shift transmission

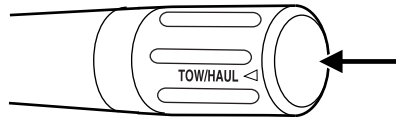

- Floor-shift transmission

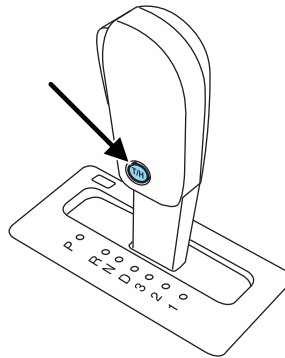

The TOW HAUL indicator light will illuminate in the instrument cluster.

**TOW
HAUL**

Tow/Haul delays upshifts to reduce frequency of transmission shifting. Tow/Haul also provides engine braking in all forward gears when the transmission is in the D (Overdrive) position; this engine braking will slow the vehicle and assist the driver in controlling the vehicle when descending a grade. Depending on driving conditions and load conditions, the transmission may downshift, slow the vehicle and control the vehicle speed when descending a hill, without the accelerator pedal being pressed. The amount of downshift braking provided will vary based upon the amount the brake pedal is depressed.

To deactivate the Tow/Haul feature and return to normal driving mode, press the button on the end of the gearshift lever. The TOW HAUL light will no longer be illuminated.

Driving

When you shut-off and restart the engine, the transmission will automatically return to normal D (Overdrive) mode (Tow/Haul OFF).



WARNING: Do not use the Tow/Haul feature when driving in icy or slippery conditions as the increased engine braking can cause the rear wheels to slide and the vehicle to swing around with the possible loss of vehicle control.

3 (Third)

Transmission operates in third gear only.

Used for improved traction on slippery roads. Selecting 3 (Third) provides engine braking.

2 (Second)

Transmission operates in 2nd gear only.

Use 2 (Second) to start-up on slippery roads or to provide additional engine braking on downgrades.

1 (First)

- Transmission operates in 1st gear only.
- Provides maximum engine braking.
- Allows upshifts by moving gearshift lever.
- Will not downshift into 1 (First) at high speeds; allows for 1 (First) when vehicle reaches slower speeds.

Forced downshifts

- Allowed in D (Drive) only.
- Press the accelerator to the floor.
- Allows transmission to select an appropriate gear.

If your vehicle gets stuck in mud or snow

If your vehicle gets stuck in mud or snow, it may be rocked out by shifting between forward and reverse gears, stopping between shifts in a steady pattern. Press lightly on the accelerator in each gear.

Do not rock the vehicle if the engine is not at normal operating temperature or damage to the transmission may occur.

Do not rock the vehicle for more than a minute or damage to the transmission and tires may occur, or the engine may overheat.

Driving

REVERSE SENSING SYSTEM (IF EQUIPPED)

The Reverse Sensing System (RSS) sounds a tone to warn the driver of obstacles near the rear bumper when R (Reverse) is selected and the vehicle is moving at speeds less than 3 mph (5 km/h). The system is not effective at speeds above 3 mph (5 km/h) and may not detect certain angular or moving objects.



WARNING: To help avoid personal injury, please read and understand the limitations of the reverse sensing system as contained in this section. Reverse sensing is only an aid for some (generally large and fixed) objects when moving in reverse on a flat surface at “parking speeds”. Inclement weather may also affect the function of the RSS; this may include reduced performance or a false activation.



WARNING: To help avoid personal injury, always use caution when in reverse and when using the RSS.



WARNING: This system is not designed to prevent contact with small or moving objects. The system is designed to provide a warning to assist the driver in detecting large stationary objects to avoid damaging the vehicle. The system may not detect smaller objects, particularly those close to the ground.



WARNING: Certain add-on devices such as large trailer hitches, bike or surfboard racks and any device that may block the normal detection zone of the RSS system may create false beeps.

The RSS detects obstacles up to 6 feet (2 meters) from the rear bumper with a decreased coverage area at the outer corners of the bumper, (refer to the figures for approximate zone coverage areas). As you move closer to the obstacle, the rate of the tone increases. When the obstacle is less than 10 inches (25.0 cm) away, the tone will sound continuously. If the RSS detects a stationary or receding object further than 10 inches (25.0 cm) from the side of the vehicle, the tone will sound for only three seconds. Once the system detects an object approaching, the tone will sound again.

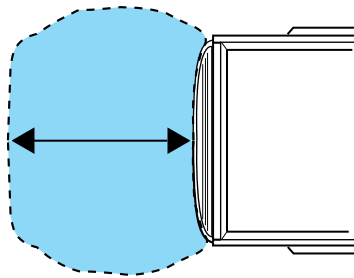
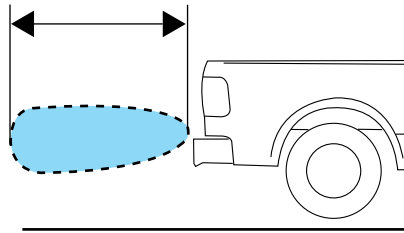

While receiving a warning the radio volume may be reduced to a predetermined level. After the warning goes away, the radio will return to the previous volume.

The RSS may have reduced performance or an increased chance of false detection if the tailgate is not locked and in the upright position. If the tailgate is down, the RSS tone may be heard intermittently or continuously. The tone may also be heard if items in the truck bed protrude rearward outside the bed.

The RSS automatically turns on when the gear selector is placed in R (Reverse) and the ignition is on. A control in the message center allows the driver to disable the system, refer to *Message center* in the *Driver Controls* chapter for more information.

Keep the RSS sensors (located on the rear bumper/fascia) free from snow, ice and large accumulations of dirt (do not clean the sensors with sharp objects). If the sensors are covered, it will affect the accuracy of the RSS.

If your vehicle sustains damage to the rear bumper/fascia, leaving it misaligned or bent, the sensing zone may be altered causing inaccurate measurement of obstacles or false alarms.

Driving

REARVIEW CAMERA SYSTEM (IF EQUIPPED)

The rearview camera system, located on the tailgate, provides a video image, which appears in the rearview mirror or the navigation system (if equipped), of the area behind the vehicle. It adds assistance to the driver while reversing or reverse parking the vehicle.

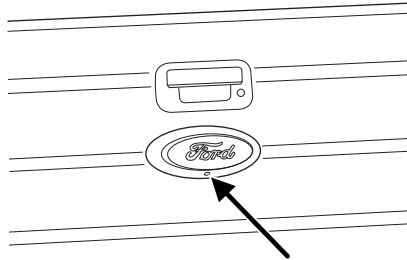

To use the camera system, place the transmission in R (Reverse); an image will display on the left portion of the rearview mirror or on the navigation screen (if equipped). The area displayed on the screen may vary according to the vehicle orientation and/or road condition.

- (1) Rear bumper
- (2) Red zone
- (3) Yellow zone
- (4) Green zone
- (5) Centerline of vehicle

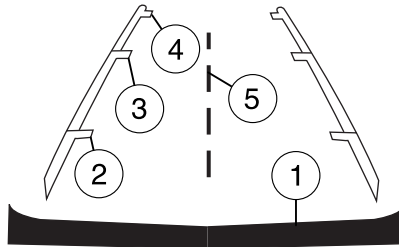

Always use caution while backing.

Objects in the red zone are closest to your vehicle and objects in the green zone are further away. Objects are getting closer to your vehicle as they move from the green zone to the yellow or red zones.

Use the side mirrors and rearview mirror to get better coverage on both sides and rear of the vehicle.

Image delay if displayed through the rearview mirror:

When shifting out of R (Reverse) and into any other gear, the image in the rearview mirror will remain on for a few seconds before it shuts off to assist in parking or trailer hookup.

Image delay if displayed through the Navigation screen:

After shifting out of R (Reverse) and into any gear other than P (Park), the image in the navigation screen will remain until the vehicle speed reaches five mph (8 km/h), only if the rear camera delay feature is on, or until any navigation radio button is pressed.

Driving

Note: The default setting for the rear camera delay is off. Press the “Settings” button found on the navigation screen (if equipped) to set the rear camera delay feature to on or off.

When towing, the camera system will only see what is being towed behind the vehicle; this might not provide adequate coverage as it usually provides in normal operation and some objects might not be seen.

The camera lens for the camera system is located on the tailgate, under the Ford Oval. Keep the lens clean so the video image remains clear and undistorted. Clean the lens with a soft, lint-free cloth and non-abrasive cleaner.

Note: If the camera system image is not clear or seems distorted, it may be covered with water droplets, snow, mud or any other substance. If this occurs, clean the camera lens before using the camera system.



WARNING: The camera system is a reverse aid supplement device that still requires the driver to use it in conjunction with the rearview mirror and the side mirrors for maximum coverage.



WARNING: Objects that are close to either corner of the bumper or under the bumper, might not be seen on the screen due to the limited coverage of the camera system.



WARNING: Backup as slow as possible since higher speeds might limit your reaction time to stop the vehicle.



WARNING: Do not use the camera system with the tailgate open.

If the back end of the vehicle is hit or damaged, then check with your authorized dealer to have your rear video system checked for proper coverage and operation.

Night time and dark area use

At night time or in dark areas, the camera system relies on the reverse lamp lighting to produce an image. Therefore it is necessary that both reverse lamps are operating in order to get a clear image in the dark. If either of the lamps are not operating, stop using the camera system, at least in the dark, until the lamp(s) are replaced and functioning.

Driving

Servicing

- If the image comes on while the vehicle is not in R (Reverse), have the system inspected by your authorized dealer.
- If the image is not clear, then check if there is anything covering the lens such as dirt, mud, ice, snow, etc. If the image is still not clear after cleaning, have your system inspected by your authorized dealer.

FOUR-WHEEL DRIVE (4WD) OPERATION (IF EQUIPPED)



WARNING: For important information regarding safe operation of this type of vehicle, see **Preparing to drive your vehicle** in this chapter.

Four-wheel drive (4WD) supplies power to all four wheels. 4WD should not be operated on dry pavement; driveline damage may occur.

If equipped with the Electronic Shift 4WD System, and 4X4 Low is selected while the vehicle is moving above 3 mph (5 km/h), the 4WD system will not perform a shift. This is normal and should be no reason for concern. Refer to *Shifting to/from 4L (4X4 Low)* for proper operation.

System indicator lights

- **4X2** - Momentarily illuminates when 2H is selected on electronic shift 4WD systems only.
- **4X4 HIGH** - Illuminates when 4H is selected.
- **4X4 LOW** - Illuminates when 4L is selected.



Driving

- **CHECK 4X4** - Illuminates when a 4X4 fault is present.



Note: When a 4X4 system fault is present, the system will typically remain in whichever 4X4 mode was selected prior to the fault condition occurring. It will not default to 4X2 in all circumstances. When this warning is displayed, have your vehicle serviced by an authorized dealer.

Using a manual 4WD system (if equipped)

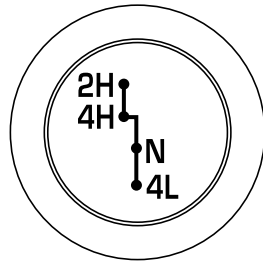

2H (4X2) – Power to the rear wheels only; used for street and highway driving. Provides optimal smoothness and fuel economy at high speeds.

4H (4X4 High) – Used for extra traction such as in snow or icy roads or in off-road situations. Not intended for use on dry pavement.

N (Neutral) – No power to either front or rear wheels.

4L (4X4 Low) – Uses extra gearing to provide maximum power to all four wheels at reduced speeds. Intended only for off-road applications such as deep sand, steep grades or pulling heavy objects. The shift lever will not engage 4L (4X4 LOW) until the transmission is in N (neutral) and the vehicle is moving below 3 mph (5 km/h); this is normal and should be no reason for concern. Refer to *Shifting to/from 4L (4X4 Low)* for proper operation.

Shifting between 2H (4X2) and 4H (4X4 high)

- Move the transfer case lever between 2H (4X2) and 4H (4X4 High) at a stop or any forward speed.

Note: Momentarily releasing the accelerator pedal while performing a shift will improve engagement/disengagement times.

Driving

Note: Do not perform this operation if the rear wheels are slipping.

Note: Some noise may be heard as the system shifts or engages; this is normal.

Shifting to/from 4L (4X4 Low)

1. Bring the vehicle to a speed of 3 mph (5 km/h) or less.
 2. Place the transmission in N (Neutral).
 3. Move the transfer case lever through N (Neutral) directly to the desired position.
- If the transfer case **will not** engage into 4L (4X4 Low) **do not force the lever**. Allow the vehicle to coast at a speed below 3 mph (5 km/h), then repeat Steps 2 and 3.

Note: Some noise may be heard as the system shifts or engages; this is normal.

Note: For proper operation in 4X4 Low, ensure the transfer case shift lever is moved entirely rearward in to the 4L (4X4 Low) position and that the 4x4 Low light is displayed in the message center.

Note: Ideal 4L (4X4 Low) shift conditions occur when the vehicle is rolling at a speed below 3 mph (5 km/h) and the transmission is in N (Neutral).

Using the N (Neutral) position

The transfer case N (Neutral) position overrides the transmission and puts the vehicle in neutral regardless of transmission gearshift lever position. The vehicle can move forward or backward.

This position should only be used when towing the vehicle.



WARNING: Do not leave the vehicle unattended with the transfer case in the N (Neutral) position. Always set the parking brake fully and turn off the ignition when leaving the vehicle.

Using the electronic shift 4WD system (if equipped)

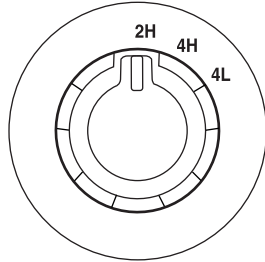

2H (4X2 High) - Power to the rear wheels only; used for street and highway driving. Provides optimal smoothness and fuel economy at high speeds.

4H (4X4 High) - Used for extra traction such as in snow or icy roads or in off-road situations. Not intended for use on dry pavement.

4L (4X4 Low) - Uses extra gearing to provide maximum power to all four wheels at reduced speeds. Intended only for off-road applications such as deep sand, steep grades or pulling heavy objects. 4L (4X4 Low) will not engage while the vehicle is moving above 3 mph (5 km/h); this is normal and should be no reason for concern. Refer to *Shifting to/from 4L (4X4 Low)* for proper operation.

Shifting between 2H (4X2 High) and 4H (4X4 High)

- Move the 4WD control between 2H (4X2 High) and 4H (4X4 High) at any forward speed.

The message center will display **4X4 SHIFT IN PROGRESS** during the system shift. "4X4 HIGH" will display in the message center.

Note: Momentarily releasing the accelerator pedal while performing a shift will improve engagement/disengagement times.

Note: Do not perform this operation if the rear wheels are slipping.

Note: Some noise may be heard as the system shifts or engages; this is normal.

Shifting to/from 4L (4X4 Low)

1. Bring the vehicle to a speed of 3 mph (5 km/h) or less.
2. Place the transmission in N (Neutral).
3. Move the 4WD control to the desired position.

Driving

The message center will display **4X4 SHIFT IN PROGRESS** during the shift. The message center will then display the system mode selected.

If any of the above shift conditions are not met, the shift will not occur and the message center will display information guiding the driver through the proper shifting procedures.

If 4X4 SHIFT IN PROGRESS is displayed for more than five seconds, transfer case gear tooth blockage is present. To alleviate this condition, move the vehicle forward approximately five feet (2 meters) to allow the transfer case to complete the shift.

Note: Some noise may be heard as the system shifts or engages; this is normal.

Electronic locking differential (ELD) (if equipped)

The electronic locking differential (ELD) is a device housed in the rear axle which allows both rear wheels to turn at the same speed. The ELD can provide additional traction should the vehicle become stuck. The ELD is electronically activated by the driver and can be shifted on the fly. It is intended for use in mud, rocks, sand, or any off-road condition where maximum traction is needed. It is not intended for use on dry pavement.

The ELD is affected by the following conditions:

- The 4WD control must be in either 4H (4X4 High) or 4L (4X4 Low) mode.
- The ELD will not engage if the vehicle speed is above 20 mph (30 km/h) in 4X4 High or 56 mph (90 km/h) in 4X4 Low.
- In 4H (4X4 High), the ELD will disengage at speeds above 25 mph (40 km/h) and will automatically reengage at speeds below 20 mph (30 km/h).
- In 4L (4X4 Low), the ELD will disengage at speeds above 62 mph (100 km/h) and will automatically reengage at speeds below 56 mph (90 km/h).

The ELD is designed for off-road use only.

Activating the electronic locking differential (ELD)

The ELD can be turned on by pulling the knob on the 4WD control toward you while the control is in either 4H (4X4 High) or 4L (4X4 Low) mode.

Once the knob is pulled, the  light located on the control will blink for approximately two seconds and then it will remain solid.

Once the  light on the control remains solid, both rear wheel axle shafts will be locked together providing added traction.

If the  light blinks for 10 seconds, then turns off, one of the following has occurred:

- The vehicle speed is too high.
- The left and right rear wheel speed difference is too high during an engagement attempt.
- The system has malfunctioned and will be accompanied by a **CHECK 4X4** message in the message center.

Note: If the ELD has difficulty disengaging, release the accelerator pedal and turn the steering wheel in the opposite direction while rolling.

Driving off-road with truck and utility vehicles

4WD vehicles are specially equipped for driving on sand, snow, mud and rough terrain and have operating characteristics that are somewhat different from conventional vehicles, both on and off the road.

How your vehicle differs from other vehicles

Truck and utility vehicles can differ from some other vehicles. Your vehicle may be higher to allow it to travel over rough terrain without getting hung up or damaging underbody components.

The differences that make your vehicle so versatile also make it handle differently than an ordinary passenger car.

Maintain steering wheel control at all times, especially in rough terrain. Since sudden changes in terrain can result in abrupt steering wheel motion, make sure you grip the steering wheel from the outside. Do not grip the spokes.

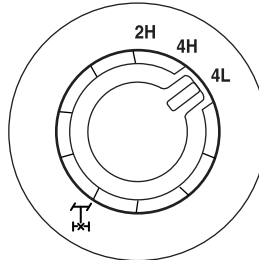

Driving

Drive cautiously to avoid vehicle damage from concealed objects such as rocks and stumps.

You should either know the terrain or examine maps of the area before driving. Map out your route before driving in the area. To maintain steering and braking control of your vehicle, you must have all four wheels on the ground and they must be rolling, not sliding or spinning.

Basic operating principles

- Do not use 4WD on dry, hard surfaced roads. Doing so will produce excessive noise, increase tire wear and may damage drive components. 4WD modes are only intended for consistently slippery or loose surfaces.
- Drive slower in strong crosswinds which can affect the normal steering characteristics of your vehicle.
- Be extremely careful when driving on pavement made slippery by loose sand, water, gravel, snow or ice.

If your vehicle goes off the edge of the pavement

- If your vehicle goes off the edge of the pavement, slow down, but avoid severe brake application, ease the vehicle back onto the pavement only after reducing your speed. Do not turn the steering wheel too sharply while returning to the road surface.
- It may be safer to stay on the apron or shoulder of the road and slow down gradually before returning to the pavement. You may lose control if you do not slow down or if you turn the steering wheel too sharply or abruptly.
- It often may be less risky to strike small objects, such as highway reflectors, with minor damage to your vehicle rather than attempt a sudden return to the pavement which could cause the vehicle to slide sideways out of control or roll over. Remember, your safety and the safety of others should be your primary concern.



WARNING: Vehicles with a higher center of gravity such as utility and four-wheel drive vehicles handle differently than vehicles with a lower center of gravity. Utility and four-wheel drive vehicles are **not** designed for cornering at speeds as high as passenger cars any more than low-slung sports cars are designed to perform satisfactorily under off-road conditions. Avoid sharp turns, excessive speed and abrupt maneuvers in these vehicles. Failure to drive cautiously could result in an increased risk of loss of vehicle control, vehicle rollover, personal injury and death.

If your vehicle gets stuck

If your vehicle gets stuck in mud or snow it may be rocked out by shifting between forward and reverse gears, stopping between shifts, in a steady pattern. Press lightly on the accelerator in each gear.

Do not rock the vehicle if the engine is not at normal operating temperature or damage to the transmission may occur.

Do not rock the vehicle for more than a few minutes or damage to the transmission and tires may occur or the engine may overheat.



WARNING: Do not spin the wheels at over 35 mph (56 km/h). The tires may fail and injure a passenger or bystander.

Emergency maneuvers

- In an unavoidable emergency situation where a sudden sharp turn must be made, remember to avoid “over-driving” your vehicle, i.e., turn the steering wheel only as rapidly and as far as required to avoid the emergency. Excessive steering will result in less vehicle control, not more. Additionally, smooth variations of the accelerator and/or brake pedal pressure should be utilized if changes in vehicle speed are called for. Avoid abrupt steering, acceleration or braking which could result in an increased risk of loss of vehicle control, vehicle rollover and/or personal injury. Use all available road surface to return the vehicle to a safe direction of travel.
- In the event of an emergency stop, avoid skidding the tires and do not attempt any sharp steering wheel movements.



WARNING: Vehicles with a higher center of gravity such as utility and four-wheel drive vehicles handle differently than vehicles with a lower center of gravity. Utility and four-wheel drive vehicles are **not** designed for cornering at speeds as high as passenger cars any more than low-slung sports cars are designed to perform satisfactorily under off-road conditions. Avoid sharp turns, excessive speed and abrupt maneuvers in these vehicles. Failure to drive cautiously could result in an increased risk of loss of vehicle control, vehicle rollover, personal injury and death.

- If the vehicle goes from one type of surface to another (i.e., from concrete to gravel) there will be a change in the way the vehicle responds to a maneuver (steering, acceleration or braking). Again, avoid these abrupt inputs.

Driving

Parking

On some 4WD vehicles, when the transfer case is in the N (Neutral) position, the engine and transmission are disconnected from the rest of the driveline. Therefore, the vehicle is free to roll even if the automatic transmission is in P (Park) or the manual transmission is in gear. Do not leave the vehicle unattended with the transfer case in the N (Neutral) position. Always set the parking brake fully and turn off the ignition when leaving the vehicle.



WARNING: Always set the parking brake fully and make sure the gearshift is latched in P (Park). Turn the ignition to the off position and remove the key whenever you leave your vehicle.



WARNING: If the parking brake is fully released, but the brake warning lamp remains illuminated, the brakes may not be working properly. See your authorized dealer.

4WD Systems

4WD (when you select a 4WD mode) uses all four wheels to power the vehicle. This increases traction, enabling you to drive over terrain and road conditions that a conventional two-wheel drive vehicle cannot.

Power is supplied to all four wheels through a transfer case. On 4WD vehicles, the transfer case allows you to select 4WD when necessary. Information on transfer case operation and shifting procedures can be found in this chapter. Information on transfer case maintenance can be found in the *Maintenance and Specifications* chapter. You should become thoroughly familiar with this information before you operate your vehicle.

Normal characteristics

On some 4WD models, the initial shift from two-wheel drive to 4x4 while the vehicle is moving can cause some momentary clunk and ratcheting sounds. This is the front drivetrain coming up to speed and the automatic locking hubs engaging and is not cause for concern.

Sand

When driving over sand, try to keep all four wheels on the most solid area of the trail. Avoid reducing the tire pressures but shift to a lower gear and drive steadily through the terrain. Apply the accelerator slowly and avoid spinning the wheels.

Driving

Avoid excessive speed because vehicle momentum can work against you and cause the vehicle to become stuck to the point that assistance may be required from another vehicle. Remember, you may be able to back out the way you came if you proceed with caution.

Mud and water

If you must drive through high water, drive slowly. Traction or brake capability may be limited.

When driving through water, determine the depth; avoid water higher than the bottom of the hubs (if possible) and proceed slowly. If the ignition system gets wet, the vehicle may stall.



Once through water, always try the brakes. Wet brakes do not stop the vehicle as effectively as dry brakes. Drying can be improved by moving your vehicle slowly while applying light pressure on the brake pedal.

Be cautious of sudden changes in vehicle speed or direction when you are driving in mud. Even 4WD vehicles can lose traction in slick mud. As when you are driving over sand, apply the accelerator slowly and avoid spinning your wheels. If the vehicle does slide, steer in the direction of the slide until you regain control of the vehicle.

If the transmission, transfer case or front axle are submerged in water, their fluids should be checked and changed, if necessary.

Driving through deep water may damage the transmission.

If the front or rear axle is submerged in water, the axle lubricant should be replaced.

After driving through mud, clean off residue stuck to rotating driveshafts and tires. Excess mud stuck on tires and rotating driveshafts causes an imbalance that could damage drive components.

“Tread Lightly” is an educational program designed to increase public awareness of land-use regulations and responsibilities in our nations wilderness areas. Ford Motor

Company joins the U.S. Forest Service and the Bureau of Land Management in encouraging you to help preserve our national forest and other public and private lands by “treading lightly.”



Driving

Driving on hilly or sloping terrain

Although natural obstacles may make it necessary to travel diagonally up or down a hill or steep incline, you should always try to drive straight up or straight down. **Avoid driving crosswise or turning on steep slopes or hills.** A danger lies in losing traction, slipping sideways and possibly rolling over. Whenever driving on a hill, determine beforehand the route you will use. Do not drive over the crest of a hill without seeing what conditions are on the other side. Do not drive in reverse over a hill without the aid of an observer.

When climbing a steep slope or hill, start in a lower gear rather than downshifting to a lower gear from a higher gear once the ascent has started. This reduces strain on the engine and the possibility of stalling.

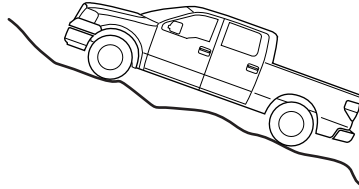

If you do stall out, do not try to turn around because you might roll over. It is better to back down to a safe location.

Apply just enough power to the wheels to climb the hill. Too much power will cause the tires to slip, spin or lose traction, resulting in loss of vehicle control.

Descend a hill in the same gear you would use to climb up the hill to avoid excessive brake application and brake overheating. Do not descend in neutral; instead, disengage overdrive or manually shift to a lower gear. When descending a steep hill, avoid sudden hard braking as you could lose control. When you brake hard, the front wheels can't turn and if they aren't turning, you won't be able to steer. The front wheels have to be turning in order to steer the vehicle. Rapid pumping of the brake pedal will help you slow the vehicle and still maintain steering control.

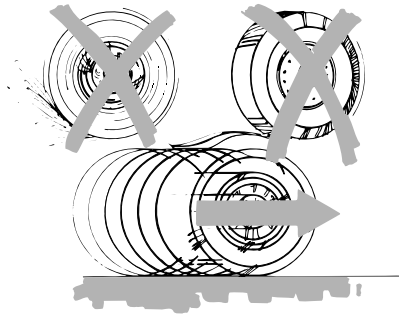

If your vehicle has anti-lock brakes, apply the brakes steadily. Do not "pump" the brakes.

Driving on snow and ice

4WD vehicles have advantages over 2WD vehicles in snow and ice but can skid like any other vehicle.

Should you start to slide while driving on snowy or icy roads, turn the steering wheel in the direction of the slide until you regain control.

Avoid sudden applications of power and quick changes of direction on snow and ice. Apply the accelerator slowly and steadily when starting from a full stop.

Avoid sudden braking as well. Although a 4WD vehicle may accelerate better than a two-wheel drive vehicle in snow and ice, it won't stop any faster, because as in other vehicles, braking occurs at all four wheels. Do not become overconfident as to road conditions.

Make sure you allow sufficient distance between you and other vehicles for stopping. Drive slower than usual and consider using one of the lower gears. In emergency stopping situations, apply the brake steadily. Do not "pump" the brakes. Refer to the *Brakes* section of this chapter for additional information on the operation of the Anti-lock Brake System (ABS).

Never drive with chains on the front tires of 4WD vehicles without also putting them on the rear tires. This could cause the rear to slide and swing around during braking.

Maintenance and Modifications

The suspension and steering systems on your vehicle have been designed and tested to provide predictable performance whether loaded or empty and durable load carrying capability. For this reason, Ford Motor Company strongly recommends that you do not make modifications such as adding or removing parts (such as lift kits or stabilizer bars) or by using replacement parts not equivalent to the original factory equipment.

Any modifications to a vehicle that raise the center of gravity can make it more likely the vehicle will roll over as a result of a loss of control. Ford Motor Company recommends that caution be used with any vehicle equipped with a high load or device (such as ladder racks or pickup box cover).

Failure to maintain your vehicle properly may void the warranty, increase your repair cost, reduce vehicle performance and operational capabilities and adversely affect driver and passenger safety. Frequent inspection of vehicle chassis components is recommended if the vehicle is subjected to heavy off-road usage.

Driving

DRIVING THROUGH WATER

If driving through deep or standing water is unavoidable, proceed very slowly especially when the depth is not known. Never drive through water that is higher than the bottom of the wheel rims (for cars) or the bottom of the hubs (for trucks).

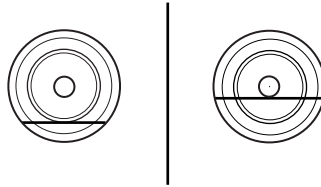

When driving through water, traction or brake capability may be limited. Also, water may enter your engine's air intake and severely damage your engine or your vehicle may stall. **Driving through deep water where the transmission vent tube is submerged may allow water into the transmission and cause internal transmission damage.**

Once through the water, always dry the brakes by moving your vehicle slowly while applying light pressure on the brake pedal. Wet brakes do not stop the vehicle as quickly as dry brakes.

SNOWPLOWING

For F-150 snowplow applications, Ford recommends the F-150 4x4 Regular Cab and SuperCab equipped with the 5.4L engine, Heavy Duty Payload Package and Snow Plow Prep Package. The Heavy Duty Payload Package for 4x4 includes unique powertrain control strategy, required for engine cooling when the raised snowplow blade blocks radiator airflow in highway driving. Factory installed snow plow prep package vehicles already have been programmed with the unique power train control strategy to provide proper cooling. If the vehicle is being upgraded to the equivalent hardware set as the snow plow prep package, then the vehicle can obtain the unique power train control strategy to provide proper cooling by getting service at an authorized dealer. The powertrain control strategy required for snowplowing to provide proper cooling may increase fan noise that may also be noticed under conditions other than snow plowing. F-150 SuperCrew, Limited and Harley-Davidson F-150 are not recommended for snowplowing and the Snow Plow Prep Package is not available.

Installing the snowplow

Weight limits and guidelines for selecting and installing the snowplow can be found in the Ford Truck Body Builders Layout Book, Snowplow section, found at www.fleet.ford.com/truckbbas. A typical installation affects the following:

- Certification to government safety laws such as occupant protection and airbag deployment, braking and lighting. Look for an "Alterer's Label" on the vehicle from the snowplow installer certifying that the installation meets all applicable Federal Motor Vehicle Safety Standards (FMVSS).
- The Total Accessory Reserve Capacity (TARC) is shown on the lower right side of the vehicle's Safety Certification Label. This is the weight of permanently-attached auxiliary equipment, such as snowplow frame-mounting hardware, that can be added to the vehicle and satisfy Ford compliance certification to FMVSS. Exceeding this weight may require the auxiliary equipment installer additional safety certification responsibility. The Front Accessory Reserve Capacity (FARC) is added for customer convenience
- Rear ballast weight behind the rear axle may be required to prevent exceeding the FGAWR, and provide front-to-rear weight balance for proper braking and steering.
- Front wheel toe may require re-adjustment to prevent premature uneven tire wear. Specifications are found in the Ford Workshop Manual.
- Headlight aim may require re-adjustment.
- The tire air pressures recommended for general driving are found on the vehicle's Safety Certification Label. The maximum cold inflation pressure for the tire and associated load rating is imprinted on the tire sidewall. Tire air pressure may require re-adjustment within these pressure limits to accommodate the additional weight of the snowplow installation

Operating the vehicle with the snowplow attached

Ford recommends that the F-150 be limited to low speed, personal-use snow removal. Do not use your vehicle for snow removal until it has been driven at least 500 miles (800 km).

Driving

The attached snowplow blade restricts airflow to the radiator, and may cause the engine to run at a higher temperature. Attention to engine temperature is especially important when outside temperatures are above freezing. Angle the blade to maximize airflow to the radiator and monitor engine temperature to determine whether a left or right angle provides the best performance.

Snowplowing with your airbag equipped vehicle

Your vehicle is equipped with a driver and passenger air bag Supplemental Restraint System (SRS) The SRS is designed to activate in certain frontal and offset frontal collisions when the vehicle sustains sufficient longitudinal deceleration.

Careless or high speed driving while plowing snow which results in sufficient vehicle decelerations can deploy the airbag. Such driving also increases the risk of accidents.



WARNING: All occupants of the vehicle, including the driver, should always properly wear their safety belts, even when an air bag supplemental restraint system (SRS) is provided.

Never remove or defeat the “tripping mechanisms” designed into the snow removal equipment by its manufacturer. Doing so may cause damage to the vehicle and the snow removal equipment as well as possible air bag deployment.



WARNING: Do not attempt to service, repair, or modify the air bag supplemental restraint system (SRS) or its fuses. See your Ford or Lincoln Mercury dealer.

Transmission operation while plowing

- Shift transfer case to 4L (4WD Low) when plowing in small areas at speeds below 5 mph (8 km/h).
- Shift transfer case to 4H (4WD High) when plowing larger areas or light snow at higher speeds. Do not exceed 15 mph (24 km/h).
- Do not shift the transmission from a forward gear to R (Reverse) until the engine is at idle and the wheels are stopped.
- If the vehicle is stuck, shift the transmission in a steady motion between forward and reverse gears. Do not rock the vehicle for more than a few minutes. The transmission and tires may be damaged or the engine can overheat.

Driving

Do not rock the vehicle if the engine is not at operating temperature. Do not rock the vehicle for more than a minute. The transmission and tires may be damaged or the engine may overheat.



WARNING: Do not spin the wheels at over 35 mph (55 km/h). The tires may fail and injure a passenger or bystander.

Engine temperature while plowing

When driving with a plow, your engine may run at a higher temperature than normal because the attached snowplow blade will restrict airflow to the radiator.

If you are driving more than 15 miles (24 km) at temperatures above freezing, angle the plow blade either full left or full right to provide maximum airflow to the radiator.

If you are driving less than 15 miles (24 km) at speeds up to 40 mph (64 km/h) in cold weather, you will not need to worry about blade position to provide maximum airflow.

Factory installed snow plow prep package vehicles already have been programmed with the unique power train control strategy to provide proper cooling. If the vehicle is being upgraded to the equivalent hardware set as the snow plow prep package, then the vehicle can obtain the unique power train control strategy to provide proper cooling by getting service at an authorized dealer. The powertrain control strategy required for snowplowing to provide proper cooling may increase fan noise that may also be noticed under conditions other than snow plowing.

Roadside Emergencies

ROADSIDE ASSISTANCE

Getting roadside assistance

To fully assist you should you have a vehicle concern, Ford Motor Company offers a complimentary roadside assistance program. This program is separate from the New Vehicle Limited Warranty. The service is available:

- 24-hours, seven days a week
- for the coverage period listed on the Roadside Assistance Card included in your Owner Guide portfolio.

Roadside assistance will cover:

- a flat tire change with a good spare (except vehicles that have been supplied with a tire inflation kit)
- battery jump start
- lock-out assistance (key replacement cost is the customer's responsibility)
- fuel delivery – Independent Service Contractors, if not prohibited by state, local or municipal law shall deliver up to 2.0 gallons (7.5L) of gasoline or 5 gallons (18.9L) of diesel fuel to a disabled vehicle. Fuel delivery service is limited to two no-charge occurrences within a 12-month period.
- winch out – available within 100 feet (30.5 meters) of a paved or county maintained road, no recoveries.
- towing – Ford/Mercury/Lincoln eligible vehicle towed to an authorized dealer within 35 miles (56.3 km) of the disablement location or to the nearest authorized dealer. If a member requests to be towed to an authorized dealer more than 35 miles (56.3 km) from the disablement location, the member shall be responsible for any mileage costs in excess of 35 miles (56.3 km).

Trailers shall be covered up to \$200 if the disabled eligible vehicle requires service at the nearest authorized dealer. If the trailer is disabled, but the towing vehicle is operational, the trailer does not qualify for any roadside services.

Canadian customers refer to your Customer Information Guide for information on:

- coverage period
- exact fuel amounts

Roadside Emergencies

- towing of your disabled vehicle
- emergency travel expense reimbursement
- travel planning benefits

In Canada, for uninterrupted Roadside Assistance coverage, you may purchase extended coverage prior to your Basic Warranty's Roadside Assistance expiring. For more information and enrollment, contact 1-877-294-2582 or visit our website at www.ford.ca.

Using roadside assistance

Complete the roadside assistance identification card and place it in your wallet for quick reference. In the United States, this card is found in the Owner Guide portfolio in the glove compartment. In Canada, the card is found in the *Customer Information Guide* in the glove compartment.

U.S. Ford, Mercury and Lincoln vehicle customers who require Roadside Assistance, call 1-800-241-3673.

Canadian customers who require roadside assistance, call 1-800-665-2006.

If you need to arrange roadside assistance for yourself, Ford Motor Company will reimburse a reasonable amount for towing to the nearest dealership within 35 miles. To obtain reimbursement information, U.S. Ford, Mercury and Lincoln vehicle customers call 1-800-241-3673. Customers will be asked to submit their original receipts.

Canadian customers who need to obtain reimbursement information, call 1-800-665-2006.

HAZARD FLASHER CONTROL

The hazard flasher control is located on the instrument panel by the radio. The hazard flashers will operate when the ignition is in any position or if the key is not in the ignition.



Push in the flasher control and all front and rear direction signals will flash. Press the flasher control again to turn them off. Use it when your vehicle is disabled and is creating a safety hazard for other motorists.

Note: With extended use, the flasher may run down your battery.

FUEL PUMP SHUT-OFF

In the event of a moderate to severe collision, this vehicle is equipped with a fuel pump shut-off feature that stops the flow of fuel to the engine. Not every impact will cause a shut-off.

Roadside Emergencies

Should your vehicle shut off after a collision due to this feature, you may restart your vehicle by doing the following:

1. Turn the ignition switch to the off position.
2. Turn the ignition switch to the on position.

In some instances the vehicle may not restart the first time you try to restart and may take one additional attempt.



WARNING: Failure to inspect and if necessary repair fuel leaks after a collision may increase the risk of fire and serious injury. Ford Motor Company recommends that the fuel system be inspected by an authorized dealer after any collision.

FUSES AND RELAYS

Fuses

If electrical components in the vehicle are not working, a fuse may have blown. Blown fuses are identified by a broken wire within the fuse. Check the appropriate fuses before replacing any electrical components.

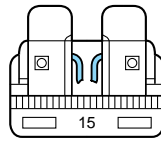

Note: Always replace a fuse with one that has the specified amperage rating. Using a fuse with a higher amperage rating can cause severe wire damage and could start a fire.

Standard fuse amperage rating and color

COLOR					
Fuse rating	Mini fuses	Standard fuses	Maxi fuses	Cartridge maxi fuses	Fuse link cartridge
2A	Grey	Grey	—	—	—
3A	Violet	Violet	—	—	—
4A	Pink	Pink	—	—	—
5A	Tan	Tan	—	—	—
7.5A	Brown	Brown	—	—	—
10A	Red	Red	—	—	—

Roadside Emergencies

COLOR					
Fuse rating	Mini fuses	Standard fuses	Maxi fuses	Cartridge maxi fuses	Fuse link cartridge
15A	Blue	Blue	—	—	—
20A	Yellow	Yellow	Yellow	Blue	Blue
25A	Natural	Natural	—	—	—
30A	Green	Green	Green	Pink	Pink
40A	—	—	Orange	Green	Green
50A	—	—	Red	Red	Red
60A	—	—	Blue	Yellow	Yellow
70A	—	—	Tan	—	Brown
80A	—	—	Natural	Black	Black

Passenger compartment fuse panel

The fuse panel is located under the right-hand side of the instrument panel.

To remove the trim panel for access to the fuse box, pull the panel toward you and swing it out away from the side and remove it. To reinstall it, line up the tabs with the grooves on the panel, then push it shut.

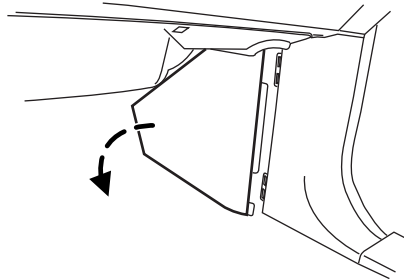

To remove the fuse box cover, press in the tabs on both sides of the cover, then pull the cover off.

To reinstall the fuse box cover, place the top part of the cover on the fuse panel, then push the bottom part of the cover until you hear it click shut. Gently pull on the cover to make sure it is seated properly.

Roadside Emergencies

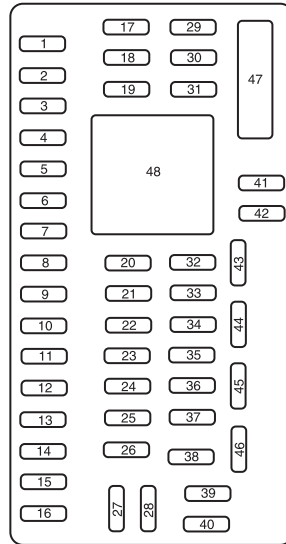

The fuses are coded as follows.

Fuse/Relay Location	Fuse Amp Rating	Protected Circuits
1	30A	Moon roof
2	15A	Not used (spare)
3	15A	Not used (spare)
4	30A	Not used (spare)
5	10A	Keypad illumination, Brake Shift Interlock (BSI), SJB microprocessor power
6	20A	Turn signals, Stop lamps
7	10A	Low beam headlamps (left)
8	10A	Low beam headlamps (right)
9	15A	Interior courtesy lights, Cargo lamps
10	15A	Backlighting, Puddle lamps

Roadside Emergencies

Fuse/Relay Location	Fuse Amp Rating	Protected Circuits
11	10A	Not used (spare)
12	7.5A	Power mirror switch, Memory seat module microprocessor power, Steering column switch
13	5A	SYNC®
14	10A	Not used (spare)
15	10A	Climate control
16	15A	Ignition switch feed
17	20A	All lock motor feeds
18	20A	Driver memory seat switch
19	25A	Not used (spare)
20	15A	Adjustable pedals, Datalink
21	15A	Fog lamps, Fog lamp indicator
22	15A	Park lamps, Side marker lamps
23	15A	High beam headlamps
24	20A	Horn
25	10A	Interior demand lamps, Mid box power feed
26	10A	Instrument panel cluster, Key out inhibit solenoid, Radio info display (CID), Radio buttons, Key-in chime
27	20A	Not used
28	5A	Radio muting
29	5A	Instrument panel cluster
30	5A	Passenger airbag disable indicator
31	10A	Restraints control module
32	10A	Non-integrated compass module, Heated-only seat module
33	10A	Trailer brake controller
34	5A	Electronic locking differential indicator

Roadside Emergencies

Fuse/Relay Location	Fuse Amp Rating	Protected Circuits
35	10A	Rear park assist
36	5A	PATS transceiver
37	10A	Not used (spare)
38	20A	Subwoofer
39	20A	Radio, Navigation display
40	20A	Not used (spare)
41	15A	Automatic dimming mirror, Door lock switch illumination, Radio accessory delay
42	10A	Not used (spare)
43	10A	Heated mirror/backlight relay, Rain sensor, Reverse camera
44	10A	Not used (spare)
45	5A	Front wiper logic, Blower motor relay
46	7.5A	Occupant classification sensor (OCS)
47	30A Circuit Breaker	Power windows, Moon roof, Power sliding backlight
48	—	Delayed accessory relay (Feeds fuse 41 and circuit breaker 47)

Power distribution box

The power distribution box is located in the engine compartment. The power distribution box contains high-current fuses that protect your vehicle's main electrical systems from overloads.



WARNING: Always disconnect the battery before servicing high current fuses.



WARNING: To reduce risk of electrical shock, always replace the cover to the Power Distribution Box before reconnecting the battery or refilling fluid reservoirs.

Roadside Emergencies

If the battery has been disconnected and reconnected, refer to the *Battery* section of the *Maintenance and Specifications* chapter.

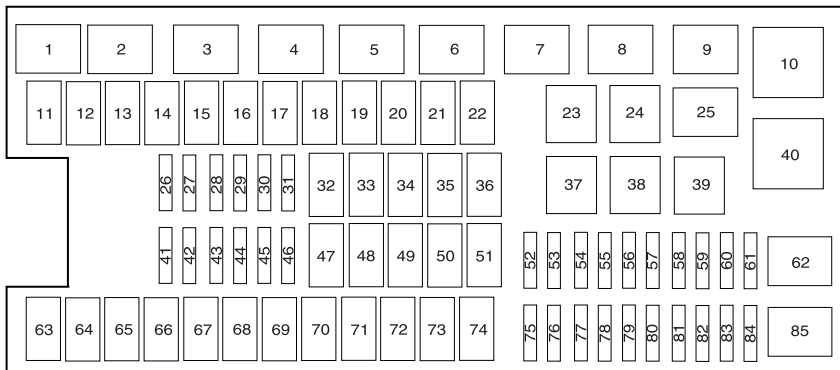

The high-current fuses are coded as follows:

Fuse/Relay Location	Fuse Amp Rating	Protected Circuits
1	—	Powertrain Control Module (PCM) power relay
2	—	Starter relay
3	—	Blower motor relay
4	—	Heated backlite relay
5	—	Not used
6	—	Trailer tow park lamp relay
7	—	Not used
8	—	Fuel pump
9	—	Trailer tow battery charger
10	—	Not used
11	30A**	Power running board motors
12	—	Not used
13	30A **	Starter relay
14	30A**	Passenger power seats

Roadside Emergencies

Fuse/Relay Location	Fuse Amp Rating	Protected Circuits
15	—	Not used
16	—	Not used
17	30A**	Trailer brake
18	—	Not used
19	—	Not used
20	20A**	4x4 module (ESOF)
21	30A**	Trailer tow battery charge
22	20A**	Cigar lighter
23	—	A/C clutch relay
24	—	Not used
25	—	Not used
26	10A*	PCM – keep alive power, Canister vent solenoid, Transmission, PCM relay
27	20A*	Fuel pump relay
28	—	Not used
29	10A*	4x4
30	10A*	A/C clutch
31	20A*	Trailer tow park lamp relay
32	40A**	Heated backlite/mirror relay
33	—	Not used
34	40A**	PCM relay
35	—	Not used
36	30A**	Roll stability control module (RSC)
37	—	Trailer tow left hand stop/turn relay
38	—	Trailer tow right hand stop/turn relay
39	—	Back up lamps
40	—	Not used
41	—	Not used

Roadside Emergencies

Fuse/Relay Location	Fuse Amp Rating	Protected Circuits
42	—	Not used
43	20A*	Backup lamp relay
44	—	Not used
45	20A*	Trailer tow stop turn relay feed
46	15A*	Brake on/off (BOO) switch
47	60A**	Roll stability control module (RSC)
48	—	Not used
49	30A**	Wiper motor, washer pump
50	—	Not used
51	40A**	Blower motor relay
52	—	Not used
53	5A*	PCM, 6R80 transmission
54	5A*	4x4 module, Back up lamp, RSC, Trailer tow battery charge relay
55	5A*	Electronic compass mirror (6R transmission only)
56	—	Not used
57	—	Not used
58	15A*	Trailer tow backup lamps
59	15A*	Heated mirrors
60	—	One-touch Start diode
61	—	Fuel pump diode
62	—	Not used
63	—	Not used
64	30A**	Amplifier
65	20A**	Auxiliary power point (instrument panel)
66	20A**	Auxiliary power point (inside center console)
67	—	Not used
68	20A**	4x4 module

Roadside Emergencies

Fuse/Relay Location	Fuse Amp Rating	Protected Circuits
69	30A**	Passenger heated/cooled seats
70	—	Not used
71	—	Not used
72	20A**	Auxiliary power point (Rear)
73	—	Not used
74	30A**	Driver power seat
75	15A*	PCM – voltage power 1
76	20A*	Voltage power 2, Voltage - battery voltage, Mass air flow/Intake air temp, CMS 12 and 22 with 6R80 transmission, Brake on/off switch (BOO)
77	10A*	Voltage power 3, Electric fan clutch, A/C clutch relay coil, Floor shifter (4-speed transmission)
78	25A*	Ignition coils, Voltage power 4
79	10A*	CMS 4-speed transmission, 12 and 22 with 4-speed transmission
80	5A*	Steering wheel illumination
81	—	Not used
82	10A*	Trailer Brake Control Module (TBCM), After market Center High Mounted Stop Lamp (CHMSL)
83	—	Not used
84	—	Not used
85	—	Not used

* Mini Fuses ** Cartridge Fuses

CHANGING THE TIRES

If you get a flat tire while driving, do not apply the brake heavily. Instead, gradually decrease your speed. Hold the steering wheel firmly and slowly move to a safe place on the side of the road.

Roadside Emergencies

Note: The tire pressure monitoring system (TPMS) indicator light will illuminate when the spare tire is in use. To restore the full functionality of the monitoring system, all road wheels equipped with tire pressure monitoring sensors must be mounted on the vehicle.

Have a flat serviced by an authorized dealer in order to prevent damage to the TPMS sensors, refer to *Tire pressure monitoring system (TPMS)* in the *Tires, Wheels and Loading* chapter. Replace the spare tire with a road tire as soon as possible. During repairing or replacing of the flat tire, have the authorized dealer inspect the TPMS sensor for damage.



WARNING: The use of tire sealants may damage your Tire Pressure Monitoring System and should not be used.



WARNING: Refer to *Tire pressure monitoring system (TPMS)* in the *Tires, Wheels and Loading* chapter for important information. If the tire pressure monitor sensor becomes damaged, it will no longer function.

Dissimilar spare tire/wheel information



WARNING: Failure to follow these guidelines could result in an increased risk of loss of vehicle control, injury or death.

If you have a dissimilar spare tire/wheel, then it is intended for temporary use only. This means that if you need to use it, you should replace it as soon as possible with a road tire/wheel that is the same size and type as the road tires and wheels that were originally provided by Ford. If the dissimilar spare tire or wheel is damaged, it should be replaced rather than repaired.

A dissimilar spare tire/wheel is defined as a spare tire and/or wheel that is different in brand, size or appearance from the road tires and wheels and can be one of three types:

1. **T-type mini-spare:** This spare tire begins with the letter “T” for tire size and may have “Temporary Use Only” molded in the sidewall
2. **Full-size dissimilar spare with label on wheel:** This spare tire has a label on the wheel that states: “THIS TIRE AND WHEEL FOR TEMPORARY USE ONLY”

Roadside Emergencies

When driving with one of the dissimilar spare tires listed above, **do not:**

- Exceed 50 mph (80 km/h)
- Load the vehicle beyond maximum vehicle load rating listed on the Safety Compliance Label
- Tow a trailer
- Use snow chains on the end of the vehicle with the dissimilar spare tire
- Use more than one dissimilar spare tire at a time
- Use commercial car washing equipment
- Try to repair the dissimilar spare tire

Use of one of the dissimilar spare tires listed above at any one wheel location can lead to impairment of the following:

- Handling, stability and braking performance
- Comfort and noise
- Ground clearance and parking at curbs
- Winter weather driving capability
- Wet weather driving capability

3. Full-size dissimilar spare without label on wheel

When driving with the full-size dissimilar spare tire/wheel, **do not:**

- Exceed 70 mph (113 km/h)
- Use more than one dissimilar spare tire/wheel at a time
- Use commercial car washing equipment
- Use snow chains on the end of the vehicle with the dissimilar spare tire/wheel

The usage of a full-size dissimilar spare tire/wheel can lead to impairment of the following:

- Handling, stability and braking performance
- Comfort and noise
- Ground clearance and parking at curbs
- Winter weather driving capability
- Wet weather driving capability
- All-Wheel driving capability (if applicable)
- Load leveling adjustment (if applicable)

Roadside Emergencies

When driving with the full-size dissimilar spare tire/wheel additional caution should be given to:

- Towing a trailer
- Driving vehicles equipped with a camper body
- Driving vehicles with a load on the cargo rack

Drive cautiously when using a full-size dissimilar spare tire/wheel and seek service as soon as possible.

Stopping and securing the vehicle

1. Park on a level surface, activate the hazard flashers and set the parking brake.
2. Place the gearshift in P (Park) and turn the engine off.

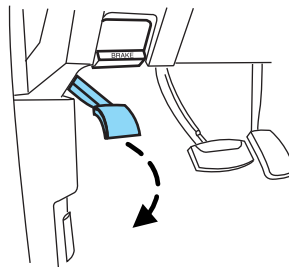

Location of the spare tire and tools

The spare tire is located under the vehicle, just forward of the rear bumper. The jack, jack handle and lug wrench are located in the following locations:

Body Style	Location
Regular Cab	Attached to a floor bracket behind the driver's seat
SuperCab	Attached to a floor bracket under the rear seat on the driver's side
SuperCrew	In a plastic box in the floor under the rear seat

To remove the jack on Regular Cab and SuperCab models:

Remove the wing nut and turn the jack screw counterclockwise to release pressure before removing the jack from the bracket.

Roadside Emergencies

To remove the jack on SuperCrew models:

1. Lift both rear seat cushions.
2. Remove the insert containing the Easy Fuel™ funnel from the driver's side.
3. Remove the two small wing nuts on the passenger side.
4. Slide the plastic box toward the driver's side and remove.

Removing the spare tire

1. Use the ignition key to remove the lock cylinder from the access hole of the bumper to allow access to the guide tube. Assemble the jack handle as shown in the illustration.

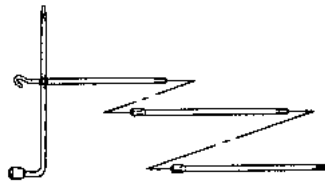

2. Fully insert the jack handle through the bumper hole and into the guide tube through the access hole in the rear bumper.

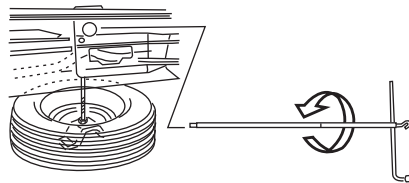

3. Turn the handle counterclockwise until tire is lowered to the ground, the tire can be slid rearward and the cable is slightly slack.
4. Slide the retainer through the center of the wheel.

Tire change procedure

WARNING: To help prevent the vehicle from moving when you change a tire, be sure the parking brake is set, then block (in both directions) the wheel that is diagonally opposite (other side and end of the vehicle) to the tire being changed.

WARNING: If the vehicle slips off the jack, you or someone else could be seriously injured.

Roadside Emergencies

 **WARNING:** Do not attempt to change a tire on the side of the vehicle close to moving traffic. Pull far enough off the road to avoid the danger of being hit when operating the jack or changing the wheel.

Refer to the instruction sheet (located with the jack) for detailed tire change instructions.

1. Block the diagonally opposite wheel.
2. Obtain the spare tire and jack from their storage locations.
3. Use the tip of the lug wrench to remove any wheel trim.
4. Loosen each wheel lug nut one-half turn counterclockwise but do not remove them until the wheel is raised off the ground.

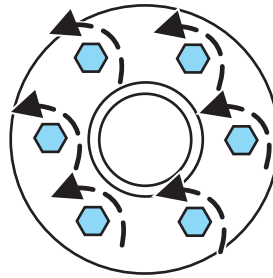
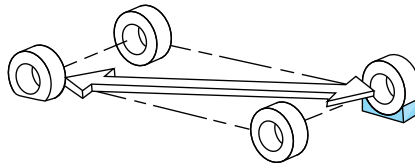

5. Position the jack according to the following guides and turn the jack handle clockwise until the wheel is completely off the ground.

 **WARNING:** When one of the rear wheels is off the ground, the transmission alone will not prevent the vehicle from moving or slipping off the jack, even if the transmission is in P (Park). To prevent the vehicle from moving when you change the tire, be sure that the parking brake is set and the diagonally opposite wheel is blocked. If the vehicle slips off the jack, someone could be seriously injured.

Roadside Emergencies

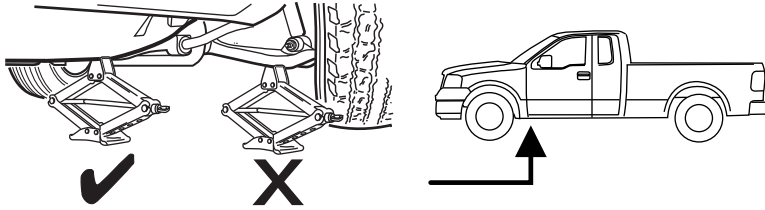

- Front

Note: Use the frame rail as the jacking location point, NOT the control arm.

- Rear

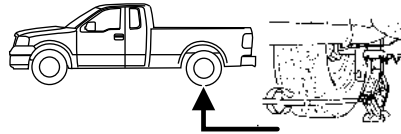

WARNING: To lessen the risk of personal injury, do not put any part of your body under the vehicle while changing a tire. Do not start the engine when your vehicle is on the jack. The jack is only meant for changing the tire.

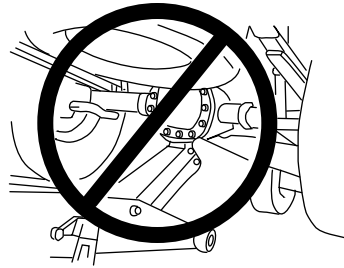

- **Never use the front or rear differential as a jacking point.**

6. Remove the lug nuts with the lug wrench.
7. Replace the flat tire with the spare tire, making sure the valve stem is facing outward. Reinstall the lug nuts until the wheel is snug against the hub. Do not fully tighten the lug nuts until the wheel has been lowered.
8. Lower the wheel by turning the jack handle counterclockwise.

Roadside Emergencies

9. Remove the jack and fully tighten the lug nuts in the order shown (Refer to *Wheel lug nut torque specifications* later in this chapter for the proper lug nut torque specification):

- Six lug nut wheel

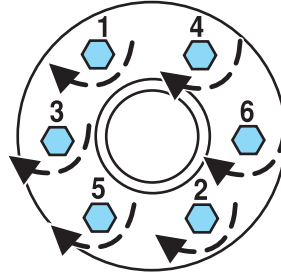

- Seven lug nut wheel

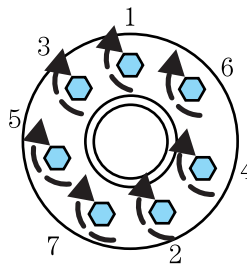

10. Stow the flat tire. Refer to *Stowing the flat/spare tire*.

11. Stow the jack and lug wrench. Make sure the jack is fastened so it does not rattle when you drive.

12. Unblock the wheels.

Stowing the flat/spare tire

Note: Failure to follow spare tire stowage instructions may result in failure of cable or loss of spare tire.

1. Lay the tire on the ground with the valve stem facing in the direction specified on the Tire Changing Instructions located with the jack hardware.

2. Slide the wheel partially under the vehicle and install the retainer through the wheel center. Pull on the cable to align the components at the end of the cable.

Roadside Emergencies

3. Turn the jack handle clockwise until the tire is raised to its stowed position underneath the vehicle. The effort to turn the jack handle increases significantly and the spare tire carrier ratchets or slips when the tire is raised to the maximum tightness. Tighten to the best of your ability, to the point where the ratchet/slip occurs, if possible. The spare tire carrier will not allow you to overtighten. If the spare tire carrier ratchets or slips with little effort, take the vehicle to your authorized dealer for assistance at your earliest convenience.
4. Check that the tire lies flat against the frame and is properly tightened. Try to push or pull, then turn the tire to be sure it will not move. Loosen and retighten, if necessary. Failure to properly stow the spare tire may result in failure of the winch cable and loss of the tire.
5. Repeat this tightness check procedure when servicing the spare tire pressure (every six months, as per your *scheduled maintenance information*), or at any time that the spare tire is disturbed through service of other components.
6. If removed, install the spare tire lock (if equipped) into the bumper drive tube with the spare tire lock key (if equipped) and jack handle.

WHEEL LUG NUT TORQUE SPECIFICATIONS

Retighten the lug nuts to the specified torque within 100 miles (160 km) after any wheel disturbance (rotation, flat tire, wheel removal, etc.).

Bolt size	Wheel lug nut torque*	
	lb.ft.	N•m
M14 x 2.0	150	200

* Torque specifications are for nut and bolt threads free of dirt and rust. Use only Ford recommended replacement fasteners.



WARNING: When a wheel is installed, always remove any corrosion, dirt or foreign materials present on the mounting surfaces of the wheel or the surface of the wheel hub, brake drum or brake disc that contacts the wheel. Ensure that any fasteners that attach the rotor to the hub are secured so they do not interfere with the mounting surfaces of the wheel. Installing wheels without correct metal-to-metal contact at the wheel mounting surfaces can cause the wheel nuts to loosen and the wheel to come off while the vehicle is in motion, resulting in loss of control.

Roadside Emergencies

Note: Inspect the wheel pilot hole prior to installation. If there is visible corrosion in wheel pilot hole, remove loose particles by wiping with clean rag and apply grease. Apply grease only to the wheel pilot hole surface by smearing a “dime” (1 square cm) sized glob of grease around the wheel pilot surface (1) with end of finger. **DO NOT** apply grease to lugnut/stud holes or wheel-to-brake surfaces.

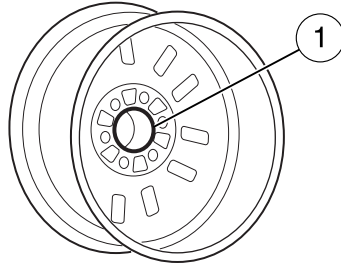



RUNNING OUT OF FUEL

If you have run out of fuel and need to refill the vehicle with a portable fuel container, see *Running out of fuel* in the *Maintenance and Specifications* chapter for proper fuel filling method using a portable fuel container and the included fuel filler funnel. **Do not** insert the nozzle of portable fuel containers or any type of aftermarket funnels into the Easy Fuel™ “no cap” fuel system as it can be damaged. You must use the included funnel in such circumstances.

 **WARNING:** Do not insert the nozzle of portable fuel containers or aftermarket funnels into the Easy Fuel™ system. This could damage the fuel system and its seal, and may cause fuel to run onto the ground instead of filling the tank, all of which could result in serious personal injury.

JUMP STARTING

 **WARNING:** The gases around the battery can explode if exposed to flames, sparks, or lit cigarettes. An explosion could result in injury or vehicle damage.

 **WARNING:** Batteries contain sulfuric acid which can burn skin, eyes and clothing, if contacted.

Do not attempt to push-start your automatic transmission vehicle. Automatic transmissions do not have push-start capability. Attempting to push-start a vehicle with an automatic transmission may cause transmission damage.

Roadside Emergencies

Preparing your vehicle

When the battery is disconnected or a new battery is installed, the automatic transmission must relearn its shift strategy. As a result, the transmission may have firm and/or soft shifts. This operation is considered normal and will not affect function or durability of the transmission. Over time, the adaptive learning process will fully update transmission operation.

1. **Use only a 12-volt supply to start your vehicle.**
2. Do not disconnect the battery of the disabled vehicle as this could damage the vehicle's electrical system.
3. Park the booster vehicle close to the hood of the disabled vehicle making sure the two vehicles **do not** touch. Set the parking brake on both vehicles and stay clear of the engine cooling fan and other moving parts.
4. Check all battery terminals and remove any excessive corrosion before you attach the battery cables. Ensure that vent caps are tight and level.
5. Turn the heater fan on in both vehicles to protect from any electrical surges. Turn all other accessories off.

Connecting the jumper cables

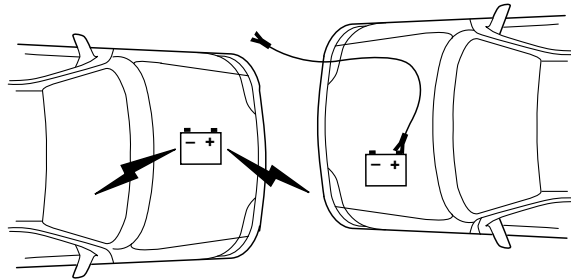

1. Connect the positive (+) jumper cable to the positive (+) terminal of the discharged battery.

Note: In the illustrations, *lightning bolts* are used to designate the assisting (boosting) battery.

Roadside Emergencies

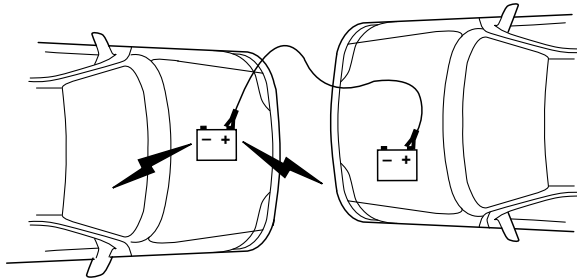

2. Connect the other end of the positive (+) cable to the positive (+) terminal of the assisting battery.

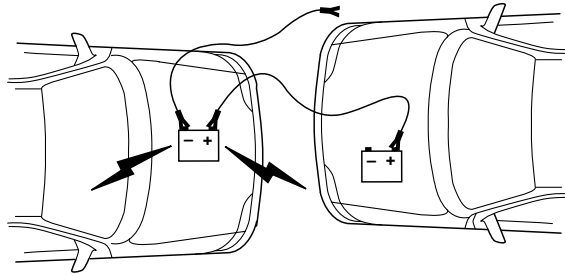

3. Connect the negative (-) cable to the negative (-) terminal of the assisting battery.

Roadside Emergencies

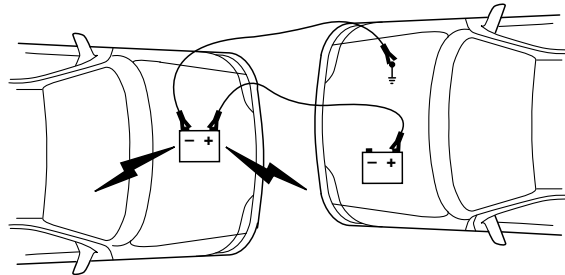

4. Make the final connection of the negative (-) cable to an exposed metal part of the stalled vehicle's engine, away from the battery and the carburetor/fuel injection system. **Do not** use fuel lines, engine rocker covers or the intake manifold as *grounding* points.



WARNING: Do not connect the end of the second cable to the negative (-) terminal of the battery to be jumped. A spark may cause an explosion of the gases that surround the battery.

5. Ensure that the cables are clear of fan blades, belts, moving parts of both engines, or any fuel delivery system parts.

Jump starting

1. Start the engine of the booster vehicle and run the engine at moderately increased speed.
2. Start the engine of the disabled vehicle.
3. Once the disabled vehicle has been started, run both engines for an additional three minutes before disconnecting the jumper cables.

Roadside Emergencies

Removing the jumper cables

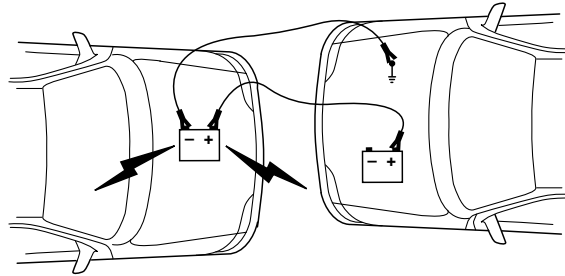

Remove the jumper cables in the reverse order that they were connected.

1. Remove the jumper cable from the *ground* metal surface.

Note: In the illustrations, *lightning bolts* are used to designate the assisting (boosting) battery.

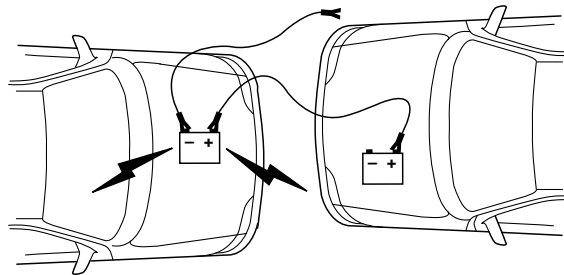

2. Remove the jumper cable on the negative (-) connection of the booster vehicle's battery.

Roadside Emergencies

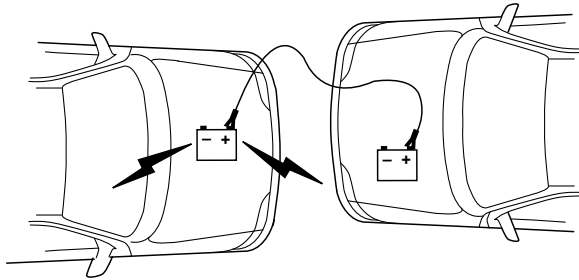

3. Remove the jumper cable from the positive (+) terminal of the booster vehicle's battery.

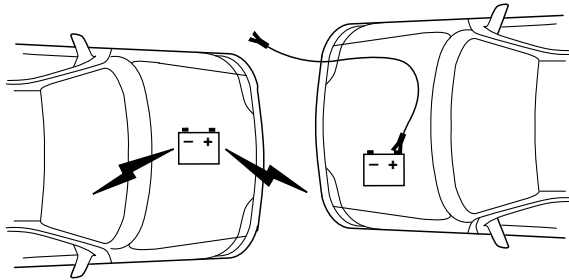

4. Remove the jumper cable from the positive (+) terminal of the disabled vehicle's battery.

After the disabled vehicle has been started and the jumper cables removed, allow it to idle for several minutes so the engine computer can *relearn* its idle conditions.

Roadside Emergencies

WRECKER TOWING

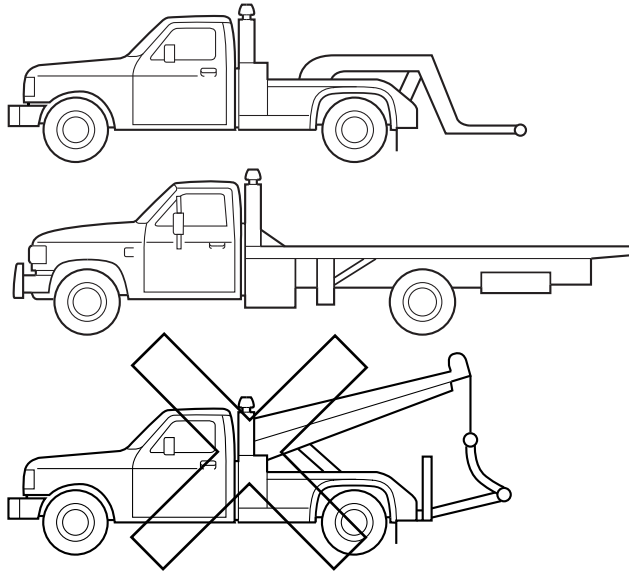

If you need to have your vehicle towed, contact a professional towing service or, if you are a member of a roadside assistance program, your roadside assistance service provider.

Ford recommends your vehicle be towed with a wheel lift or flatbed. Do not tow with a slingbelt. Ford Motor Company has not approved a slingbelt towing procedure.

On 4x2 vehicles, it is acceptable to tow the vehicle with the front wheels on the ground (without dollies) and the rear wheels off the ground.

On 4x4 vehicles, it is recommended that your vehicle be towed with a wheel lift and dollies or flatbed equipment with all the wheels off the ground.

If the vehicle is towed by other means or incorrectly, vehicle damage may occur.

Roadside Emergencies

Emergency towing

In case of a roadside emergency with a disabled vehicle (without access to wheel dollies, car hauling trailer, or flatbed transport vehicle) your vehicle (regardless of transmission powertrain configuration) can be flat towed (all wheels on the ground) under the following conditions:

- Vehicle is facing forward so that it is being towed in a forward direction.
- Place the transmission in N (Neutral). If you cannot move the gear shift lever, refer to *Brake shift interlock* in the *Driving* chapter for instructions.
- Maximum speed is not to exceed 35 mph (56 km/h).
- Maximum distance is 50 miles (80 km).

Customer Assistance

GETTING THE SERVICES YOU NEED

Warranty repairs to your vehicle must be performed by an authorized Ford, Lincoln, or Mercury dealer. While any authorized dealer handling your vehicle line will provide warranty service, we recommend you return to your selling authorized dealer who wants to ensure your continued satisfaction.

Please note that certain warranty repairs require special training and/or equipment, so not all authorized dealers are authorized to perform all warranty repairs. This means that, depending on the warranty repair needed, you may have to take your vehicle to another authorized dealer.

A reasonable time must be allowed to perform a repair after taking your vehicle to the authorized dealer. Repairs will be made using Ford or Motorcraft parts, or remanufactured or other parts that are authorized by Ford.

Away from home

If you are away from home when your vehicle needs service, contact the Ford Customer Relationship Center or use the online resources listed below to find the nearest authorized dealer.

In the United States:

Mailing address

Ford Motor Company
Customer Relationship Center
P.O. Box 6248
Dearborn, MI 48121

Telephone

1-800-392-3673 (FORD)
(TDD for the hearing impaired: 1-800-232-5952)

Online

Additional information and resources are available online at www.genuineservice.com.

- U.S. dealer locator by Dealer Name, City/State, or Zip Code
- Owner Guides
- Maintenance Schedules
- Recalls
- Ford Extended Service Plans
- Ford Genuine Accessories
- Service specials and promotions.

Customer Assistance

In Canada:

Mailing address (Ford vehicles)

Customer Relationship Centre
Ford Motor Company of Canada, Limited
P.O. Box 2000
Oakville, Ontario L6J 5E4

Telephone

1-800-565-3673 (FORD)

Online

www.ford.ca

Mailing address (Lincoln vehicles)

Lincoln Centre
Ford Motor Company of Canada, Limited
P.O. Box 2000
Oakville, Ontario L6J 5E4

Telephone

1-800-387-9333

Online

www.lincolncanada.com

Additional assistance

If you have questions or concerns, or are unsatisfied with the service you are receiving, follow these steps:

1. Contact your Sales Representative or Service Advisor at your selling/servicing authorized dealer.
2. If your inquiry or concern remains unresolved, contact the Sales Manager, Service Manager or Customer Relations Manager.
3. If you require assistance or clarification on Ford Motor Company policies, please contact the Ford Customer Relationship Center

In order to help you serve you better, please have the following information available when contacting a Customer Relationship Center:

- Vehicle Identification Number (VIN)
- Your telephone number (home and business)
- The name of the authorized dealer and city where located
- The vehicle's current odometer reading

In some states, you must directly notify Ford in writing before pursuing remedies under your state's warranty laws. Ford is also allowed a final repair attempt in some states.

Customer Assistance

In the United States, a warranty dispute must be submitted to the BBB AUTO LINE before taking action under the Magnuson-Moss Warranty Act, or to the extent allowed by state law, before pursuing replacement or repurchase remedies provided by certain state laws. This dispute handling procedure is not required prior to enforcing state created rights or other rights which are independent of the Magnuson-Moss Warranty Act or state replacement or repurchase laws.

IN CALIFORNIA (U.S. ONLY)

California Civil Code Section 1793.2(d) requires that, if a manufacturer or its representative is unable to repair a motor vehicle to conform to the vehicle's applicable express warranty after a reasonable number of attempts, the manufacturer shall be required to either replace the vehicle with one substantially identical or repurchase the vehicle and reimburse the buyer in an amount equal to the actual price paid or payable by the consumer (less a reasonable allowance for consumer use). The consumer has the right to choose whether to receive a refund or replacement vehicle.

California Civil Code Section 1793.22(b) presumes that the manufacturer has had a reasonable number of attempts to conform the vehicle to its applicable express warranties if, within the first 18 months of ownership of a new vehicle or the first 18,000 miles (29,000 km), whichever occurs first:

1. Two or more repair attempts are made on the same non-conformity likely to cause death or serious bodily injury OR
2. Four or more repair attempts are made on the same nonconformity (a defect or condition that substantially impairs the use, value or safety of the vehicle) OR
3. The vehicle is out of service for repair of nonconformities for a total of more than 30 calendar days (not necessarily all at one time)

In the case of 1 or 2 above, the consumer must also notify the manufacturer of the need for the repair of the nonconformity at the following address:

Ford Motor Company
16800 Executive Plaza Drive
Mail Drop 3NE-B
Dearborn, MI 48126

THE BETTER BUSINESS BUREAU (BBB) AUTO LINE PROGRAM (U.S. ONLY)

Your satisfaction is important to Ford Motor Company and to your dealer. If a warranty concern has not been resolved using the three-step

Customer Assistance

procedure outlined on the first page of the *Customer Assistance* section, you may be eligible to participate in the BBB AUTO LINE program.

The BBB AUTO LINE program consists of two parts – mediation and arbitration. During mediation, a representative of the BBB will contact both you and Ford Motor Company to explore options for settlement of the claim. If an agreement is not reached during mediation and your claim is eligible, you may participate in the arbitration process. An arbitration hearing will be scheduled so that you can present your case in an informal setting before an impartial person. The arbitrator will consider the testimony provided and make a decision after the hearing.

You are not bound by the decision, but should you choose to accept the BBB AUTO LINE decision, Ford must abide by the accepted decision as well. Disputes submitted to the BBB AUTO LINE program are usually decided within forty days after you file your claim with the BBB.

BBB AUTO LINE Application: Using the information provided below, please call or write to request a program application. You will be asked for your name and address, general information about your new vehicle, information about your warranty concerns, and any steps you have already taken to try to resolve them. A Customer Claim Form will be mailed that will need to be completed, signed and returned to the BBB along with proof of ownership. Upon receipt, the BBB will review the claim for eligibility under the Program Summary Guidelines.

You can get more information by calling BBB AUTO LINE at 1-800-955-5100, or writing to:

**BBB AUTO LINE
4200 Wilson Boulevard, Suite 800
Arlington, Virginia 22203-1833**

BBB AUTO LINE applications can also be requested by calling the Ford Motor Company Customer Relationship Center at 1-800-392-3673.

Note: Ford Motor Company reserves the right to change eligibility limitations, modify procedures, or to discontinue this process at any time without notice and without obligation.

UTILIZING THE MEDIATION/ARBITRATION PROGRAM (CANADA ONLY)

For vehicles delivered to authorized Canadian dealers. In those cases where you continue to feel that the efforts by Ford of Canada and the authorized dealer to resolve a factory-related vehicle service concern have been unsatisfactory, Ford of Canada participates in an impartial third party mediation/arbitration program administered by the Canadian Motor Vehicle Arbitration Plan (CAMVAP).

Customer Assistance

The CAMVAP program is a straight-forward and relatively speedy alternative to resolve a disagreement when all other efforts to produce a settlement have failed. This procedure is without cost to you and is designed to eliminate the need for lengthy and expensive legal proceedings.

In the CAMVAP program, impartial third-party arbitrators conduct hearings at mutually convenient times and places in an informal environment. These impartial arbitrators review the positions of the parties, make decisions and, when appropriate, render awards to resolve disputes. CAMVAP decisions are fast, fair, and final as the arbitrator's award is binding both to you and Ford of Canada.

CAMVAP services are available in all territories and provinces. For more information, without charge or obligation, call your CAMVAP Provincial Administrator directly at 1-800-207-0685.

FORD EXTENDED SERVICE PLAN

You can get more protection for your new car or light truck by purchasing Ford Extended Service Plan (Ford ESP) coverage. It provides the following:

- Benefits during the warranty period depending on the plan you purchase (such as: reimbursement for rentals; coverage for certain maintenance and wear items).
- Protection against covered repair costs after your Bumper-to-Bumper Warranty expires.

You may purchase Ford ESP from any participating authorized dealer. There are several plans available in various time, distance and deductible combinations which can be tailored to fit your own driving needs. Ford ESP also offers reimbursement benefits for towing and rental coverage.

When you buy Ford ESP, you receive Peace-of-Mind protection throughout the United States and Canada, provided by a network of more than 4,600 participating authorized dealers.

If you did not take advantage of the Ford Extended Service Plan at the time of purchasing your vehicle, you may still be eligible. Since this information is subject to change, please ask your authorized dealer for complete details about Ford Extended Service Plan coverage options, or visit the Ford ESP website at www.ford-esp.com.

GETTING ASSISTANCE OUTSIDE THE U.S. AND CANADA

Before exporting your vehicle to a foreign country, contact the appropriate foreign embassy or consulate. These officials can inform you of local vehicle registration regulations and where to find unleaded fuel.

Customer Assistance

If you cannot find unleaded fuel or can only get fuel with an anti-knock index lower than is recommended for your vehicle, contact a regional office or owner relations/customer relationship office.

The use of leaded fuel in your vehicle without proper conversion may damage the effectiveness of your emission control system and may cause engine knocking or serious engine damage. Ford Motor Company/Ford of Canada is not responsible for any damage caused by use of improper fuel. Using leaded fuel may also result in difficulty importing your vehicle back into the U.S.

If your vehicle must be serviced while you are traveling or living in Central America, the Caribbean, or the Middle East, contact the nearest authorized dealer. If the authorized dealer cannot help you, contact:

FORD MOTOR COMPANY
FORD EXPORT OPERATIONS
1555 Fairlane Drive
Fairlane Business Park #3
Allen Park, Michigan 48101
U.S.A.
Telephone: (313) 594-4857
FAX: (313) 390-0804
Email: expcac@ford.com

If you are in another foreign country, contact the nearest authorized dealer. If the authorized dealer employees cannot help you, they can direct you to the nearest Ford affiliate office.

If you buy your vehicle in North America and then relocate outside of the U.S. or Canada, register your vehicle identification number (VIN) and new address with Ford Motor Company Export Operations.

Customers in the U.S. should call 1-800-392-3673.

ORDERING ADDITIONAL OWNER'S LITERATURE

To order the publications in this portfolio, contact Helm, Incorporated at:

HELM, INCORPORATED
P.O. Box 07150
Detroit, Michigan 48207

Or to order a free publication catalog, call toll free: 1-800-782-4356

Monday-Friday 8:00 a.m. - 6:00 p.m. EST

Helm, Incorporated can also be reached by their website:
www.helminc.com.

(Items in this catalog may be purchased by credit card, check or money order.)

Customer Assistance

Obtaining a French owner's guide

French Owner's Guides can be obtained from your authorized dealer or by writing to:

Ford Motor Company of Canada, Limited
Service Publications CHQ202
The Canadian Road
P.O. Box 2000
Oakville, ON, Canada
L6J 5E4

REPORTING SAFETY DEFECTS (U.S. ONLY)

If you believe that your vehicle has a defect which could cause a crash or could cause injury or death, you should immediately inform the National Highway Traffic Safety



Administration (NHTSA) in addition to notifying Ford Motor Company.

If NHTSA receives similar complaints, it may open an investigation, and if it finds that a safety defect exists in a group of vehicles, it may order a recall and remedy campaign. However, NHTSA cannot become involved in individual problems between you, your dealer, or Ford Motor Company.

To contact NHTSA, you may call the Vehicle Safety Hotline toll-free at 1-888-327-4236 (TTY: 1-800-424-9153); go to <http://www.safercar.gov>; or write to:

Administrator
1200 New Jersey Avenue, Southeast
Washington, D.C. 20590

You can also obtain other information about motor vehicle safety from <http://www.safercar.gov>.

REPORTING SAFETY DEFECTS (CANADA ONLY)

If you believe that your vehicle has a defect which could cause a crash or could cause injury or death, you should immediately inform Transport Canada, using their toll-free number: 1-800-333-0510.

Cleaning

WASHING THE EXTERIOR

Wash your vehicle regularly with cool or lukewarm water and a neutral pH shampoo, such as Motorcraft Detail Wash (ZC-3-A), which is available from your authorized dealer.

- Never use strong household detergents or soap, such as dish washing or laundry liquid. These products can discolor and spot painted surfaces.
- Never wash a vehicle that is “hot to the touch” or during exposure to strong, direct sunlight.
- Always use a clean sponge or car wash mitt with plenty of water for best results.
- Dry the vehicle with a chamois or soft terry cloth towel in order to eliminate water spotting.
- It is especially important to wash the vehicle regularly during the winter months, as dirt and road salt are difficult to remove and cause damage to the vehicle.
- Immediately remove items such as gasoline, diesel fuel, bird droppings and insect deposits because they can cause damage to the vehicle’s paintwork and trim over time. Use Motorcraft Bug and Tar Remover (ZC-42), which is available from your authorized dealer.
- Remove any exterior accessories, such as antennas, before entering a car wash.
- **Suntan lotions and insect repellents can damage any painted surface; if these substances come in contact with your vehicle, wash off as soon as possible.**
- **If your vehicle is equipped with running boards, do not use rubber, plastic and vinyl protectant products on the running board surface, as the area may become slippery.**

Exterior chrome

- Wash the vehicle first, using cool or lukewarm water and a neutral pH shampoo, such as Motorcraft Detail Wash (ZC-3-A).
- Use Motorcraft Custom Bright Metal Cleaner (ZC-15), available from your authorized dealer. Apply the product as you would a wax to clean bumpers and other chrome parts; allow the cleaner to dry for a few minutes, then wipe off the haze with a clean, dry rag.
- **Never use abrasive materials such as steel wool or plastic pads as they can scratch the chrome surface.**

Cleaning

- After polishing chrome bumpers, apply a coating of Motorcraft Premium Liquid Wax (ZC-53-A), available from your authorized dealer, or an equivalent quality product to help protect from environmental effects.

WAXING

- Wash the vehicle first.
- Do not use waxes that contain abrasives; use Motorcraft Premium Liquid Wax (ZC-53-A), which is available from your authorized dealer, or an equivalent quality product.
- Do not allow paint sealant to come in contact with any non-body (low-gloss black) colored trim, such as grained door handles, roof racks, bumpers, side moldings, mirror housings or the windshield cowl area. The paint sealant will “gray” or stain the parts over time.

PAINT CHIPS

Your authorized dealer has touch-up paint to match your vehicle's color. Take your color code (printed on a sticker in the driver's door jamb) to your authorized dealer to ensure you get the correct color.

- Remove particles such as bird droppings, tree sap, insect deposits, tar spots, road salt and industrial fallout before repairing paint chips.
- Always read the instructions before using the products.

ALUMINUM WHEELS AND WHEEL COVERS

Aluminum wheels and wheel covers are coated with a clearcoat paint finish. In order to maintain their shine:

- Clean weekly with Motorcraft Wheel and Tire Cleaner (ZC-37-A), which is available from your authorized dealer. Heavy dirt and brake dust accumulation may require agitation with a sponge. Rinse thoroughly with a strong stream of water.
- Never apply any cleaning chemical to hot or warm wheel rims or covers.
- Some automatic car washes may cause damage to the finish on your wheel rims or covers. Chemical-strength cleaners, or cleaning chemicals, in combination with brush agitation to remove brake dust and dirt, could wear away the clearcoat finish over time.
- Do not use hydrofluoric acid-based or high caustic-based wheel cleaners, steel wool, fuels or strong household detergent.
- To remove tar and grease, use Motorcraft Bug and Tar Remover (ZC-42), available from your authorized dealer.

Cleaning

ENGINE

Engines are more efficient when they are clean because grease and dirt buildup keep the engine warmer than normal. When washing:

- Take care when using a power washer to clean the engine. The high-pressure fluid could penetrate the sealed parts and cause damage.
- Do not spray a hot engine with cold water to avoid cracking the engine block or other engine components.
- Spray Motorcraft Engine Shampoo and Degreaser (ZC-20) on all parts that require cleaning and pressure rinse clean. In Canada use Motorcraft Engine Shampoo (CXC-66-A).
- Cover the highlighted areas to prevent water damage when cleaning the engine.
- Never wash or rinse the engine while it is running; water in the running engine may cause internal damage.

4.6L ENGINE

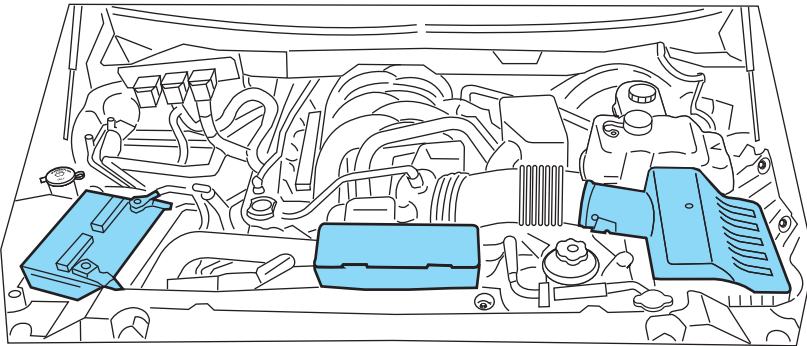

5.4L ENGINE

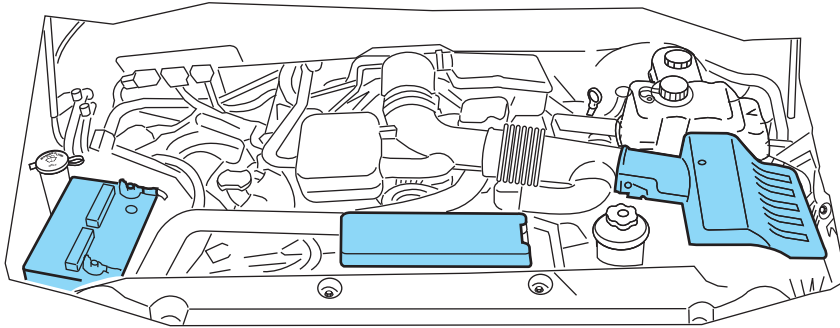

PLASTIC (NON-PAINTED) EXTERIOR PARTS

Use only approved products to clean plastic parts. These products are available from your authorized dealer.

- For routine cleaning, use Motorcraft Detail Wash (ZC-3-A).
- If tar or grease spots are present, use Motorcraft Bug and Tar Remover (ZC-42).
- For plastic headlamp lenses, use Motorcraft Ultra Clear Spray Glass Cleaner (ZC-23).

WINDOWS AND WIPER BLADES

The windshield, rear and side windows and the wiper blades should be cleaned regularly. If the wipers do not wipe properly, substances on the vehicle's glass or the wiper blades may be the cause. These may include hot wax treatments used by commercial car washes, water repellent coatings, tree sap, or other organic contamination; these contaminants may cause squeaking or chatter noise from the blades, and streaking and smearing of the windshield. To clean these items, follow these tips:

- The windshield, rear windows and side windows may be cleaned with a non-abrasive cleaner such as Motorcraft Ultra-Clear Spray Glass Cleaner (ZC-23), available from your authorized dealer.

Cleaning

- The wiper blades can be cleaned with isopropyl (rubbing) alcohol or Motorcraft Premium Windshield Washer Concentrate (ZC-32-A), available from your authorized dealer. This washer fluid contains special solution in addition to alcohol which helps to remove the hot wax deposited on the wiper blade and windshield from automated car wash facilities. Be sure to replace wiper blades when they appear worn or do not function properly.
- Do not use abrasives, as they may cause scratches.
- Do not use fuel, kerosene, or paint thinner to clean any parts.

If you cannot remove those streaks after cleaning with the glass cleaner or if the wipers chatter and move in a jerky motion, clean the outer surface of the windshield and the wiper blades using a sponge or soft cloth with a neutral detergent or mild-abrasive cleaning solution. After cleaning, rinse the windshield and wiper blades with clean water. The windshield is clean if beads do not form when you rinse the windshield with water.

Do not use sharp objects, such as a razor blade, to clean the inside of the rear window or to remove decals, as it may cause damage to the rear window defroster's heated grid lines (if equipped).

INSTRUMENT PANEL/INTERIOR TRIM AND CLUSTER LENS

Clean the instrument panel, interior trim areas and cluster lens with a clean and damp white cotton cloth, then with a clean and dry white cotton cloth; you may also use Motorcraft Dash & Vinyl Cleaner (ZC-38-A) on the instrument panel and interior trim areas.

- Avoid cleaners or polishes that increase the gloss of the upper portion of the instrument panel. The dull finish in this area helps protect the driver from undesirable windshield reflection.
- Be certain to wash or wipe your hands clean if you have been in contact with certain products such as insect repellent and suntan lotion in order to avoid possible damage to the interior painted surfaces.
- Do not use household or glass cleaners as these may damage the finish of the instrument panel, interior trim and cluster lens.



WARNING: Do not use chemical solvents or strong detergents when cleaning the steering wheel or instrument panel to avoid contamination of the airbag system.

Cleaning

If a staining liquid like coffee/juice has been spilled on the instrument panel or on interior trim surfaces, clean as follows:

1. Wipe up spilled liquid using a clean, white, cotton cloth.
2. Apply Motorcraft Deluxe Leather and Vinyl Cleaner (ZC-11-A) [In Canada use Motorcraft Multi-Purpose Cleaner (CXC-101)] to the wiped area and spread around evenly.
3. Apply more Motorcraft cleaner to a clean, white, cotton cloth and press the cloth onto the soiled area—allow this to set at room temperature for 30 minutes.
4. Remove the soaked cloth, and if it is not soiled badly, use this cloth to clean the area by using a rubbing motion for 60 seconds.
5. Following this, wipe area dry with a clean, white, cotton cloth.

INTERIOR

For fabric, carpets, cloth seats and safety belts:

- Remove dust and loose dirt with a vacuum cleaner.
- Remove light stains and soil with Motorcraft Professional Strength Carpet & Upholstery Cleaner (ZC-54).
- If grease or tar is present on the material, spot-clean the area first with Motorcraft Spot and Stain Remover (ZC-14). In Canada, use Motorcraft Multi-Purpose Cleaner (CXC-101).
- If a ring forms on the fabric after spot cleaning, clean the entire area immediately (but do not oversaturate) or the ring will set.
- Do not use household cleaning products or glass cleaners, which can stain and discolor the fabric and affect the flame retardant abilities of the seat materials.



WARNING: Do not use cleaning solvents, bleach or dye on the vehicle's seatbelts, as these actions may weaken the belt webbing.

LEATHER SEATS (IF EQUIPPED, EXCEPT FOR THE KING RANCH SUPERCREW)

Your leather seating surfaces have a clear, protective coating over the leather.

For King Ranch SuperCrew leather seats, refer to separate section in this chapter.

Cleaning

- For routine cleaning, wipe the surface with a soft, damp cloth. For more thorough cleaning, wipe the surface with a mild soap and water solution. In Canada, use Motorcraft Vinyl Cleaner (CXC-93). Dry the area with a soft cloth.
- If the leather cannot be completely cleaned using a mild soap and water solution, the leather may be cleaned using a commercially available cleaning product designed for automotive interiors.
- Do not use household cleaning products, alcohol solutions, solvents or cleaners intended for rubber, vinyl and plastics, or oil/petroleum-based leather conditioners. These products may cause premature wearing of the clear, protective coating.

Note: In some instances, color or dye transfer can occur when wet clothing comes in contact with leather upholstery. If this occurs, the leather should be cleaned immediately to avoid permanent staining.

Leather seats for the King Ranch SuperCrew only (if equipped)

Your vehicle is equipped with seating covered in premium, top-grain leather which is extremely durable, but still requires special care and maintenance in order to ensure longevity and comfort.

Regular cleaning and conditioning will maintain the appearance of the leather. Failure to care for the leather can result in drying out and fading of the material.

Note: In some instances, color or dye transfer can occur when wet clothing comes in contact with leather upholstery. If this occurs, the leather should be cleaned immediately to avoid permanent staining.

Cleaning

For dirt, use a vacuum cleaner then use a clean, damp cloth or soft brush.

For routine cleaning, wipe the surface with a soft, damp cloth. For more thorough cleaning, wipe the surface with a mild soap. If the leather cannot be completely cleaned using a mild soap and water solution, the leather may be cleaned using a commercially available cleaning product “Tanners Preserve Leather Cleaner” and a 3M “Type T” scrubbing pad.

- Clean spills as quickly as possible.
- Test any cleaner or stain remover on an inconspicuous part of the leather as cleaners may darken the leather. For more specific cleaning information, contact the King Ranch Saddle Shop at 1-800-282-KING (5464).

Cleaning

- Do not spill coffee, ketchup, mustard, orange juice or oil-based products on the leather as they may permanently stain the leather.
- Do not use household cleaning products, alcohol solutions, solvents or cleaners intended for rubber, vinyl or plastics.

Scratches

Natural Markings - Because the leather in the seat comes from genuine steer hides, there will be evidence of naturally occurring markings, such as small scars. These markings give character to the seating covers and should be considered as proof of a genuine leather product.

In order to lessen the appearance of certain scratches and other wear marks, apply conditioner on the affected area following the same instructions as in the *Conditioning* section.

Conditioning

Bottles of King Ranch Leather Conditioner are available at the King Ranch Saddle Shop. Visit the Web site at www.krsaddleshop.com, or telephone (in the United States) 1-800-282-KING (5464). If you are unable to obtain King Ranch Leather Conditioner, use another premium leather conditioner.

- Apply your first conditioning treatment within six months of taking delivery of your vehicle. Condition twice yearly in order to replenish lost oils and revitalize the aroma, suppleness and resilience of the leather.
- Clean the surfaces using the steps outlined in the *Cleaning* section.
- Ensure the leather is dry then apply a nickel-sized amount of conditioner to a clean, dry cloth
- Rub the conditioner into leather until it disappears. Allow the conditioner to dry and repeat the process for the entire interior. If a film appears, wipe off film with a dry, clean cloth.

UNDERBODY

Flush the complete underside of your vehicle frequently. Keep body and door drain holes free from packed dirt.

Cleaning

FORD AND LINCOLN MERCURY CAR CARE PRODUCTS

Your Ford or Lincoln Mercury authorized dealer has many quality products available to clean your vehicle and protect its finishes. These quality products have been specifically engineered to fulfill your automotive needs; they are custom designed to complement the style and appearance of your vehicle. Each product is made from high quality materials that meet or exceed rigid specifications. For best results, use the following products or products of equivalent quality:

- Motorcraft Bug and Tar Remover (ZC-42)
- Motorcraft Car Wash (Canada only) (CXC-83)
- Motorcraft Custom Bright Metal Cleaner (ZC-15)
- Motorcraft Custom Clear Coat Polish (ZC-8-A)
- Motorcraft Custom Vinyl Protectant (ZC-40-A)
- Motorcraft Dash and Vinyl Cleaner (ZC-38-A)
- Motorcraft Deluxe Leather and Vinyl Cleaner (U.S. only) (ZC-11-A)
- Motorcraft Leather Care Kit (U.S. only) (ZC-11-D)
- Motorcraft Detail Wash (ZC-3-A)
- Motorcraft Dusting Cloth (ZC-24)
- Motorcraft Engine Shampoo and Degreaser (U.S. only) (ZC-20)
- Motorcraft Engine Shampoo (Canada only) (CXC-66-A)
- Motorcraft Multi-Purpose Cleaner (Canada only) (CXC-101)
- Motorcraft Premium Glass Cleaner (Canada only) (CXC-100)
- Motorcraft Premium Liquid Wax (ZC-53-A)
- Motorcraft Premium Windshield Washer Concentrate (U.S. only) (ZC-32-A)
- Motorcraft Professional Strength Carpet & Upholstery Cleaner (ZC-54)
- Motorcraft Spot and Stain Remover (U.S. only) (ZC-14)
- Motorcraft Tire Clean and Shine (ZC-28)
- Motorcraft Triple Clean (U.S. only) (ZC-13)
- Motorcraft Ultra-Clear Spray Glass Cleaner (ZC-23)
- Motorcraft Vinyl Cleaner (Canada only) (CXC-93)
- Motorcraft Wash and Wax (Canada only) (CXC-95)
- Motorcraft Wheel and Tire Cleaner (ZC-37-A)

Maintenance and Specifications

SERVICE RECOMMENDATIONS

To help you service your vehicle, we provide *scheduled maintenance information* which makes tracking routine service easy.

If your vehicle requires professional service, your authorized dealer can provide the necessary parts and service. Check your *Warranty Guide/Customer Information Guide* to find out which parts and services are covered.

Use only recommended fuels, lubricants, fluids and service parts conforming to specifications. Motorcraft parts are designed and built to provide the best performance in your vehicle.

PRECAUTIONS WHEN SERVICING YOUR VEHICLE

- Do not work on a hot engine.
- Make sure that nothing gets caught in moving parts.
- Do not work on a vehicle with the engine running in an enclosed space, unless you are sure you have enough ventilation.
- Keep all open flames and other lit material away from the battery and all fuel related parts.



WARNING: Turn off the power running boards, if equipped, before working under the vehicle, jacking or placing any object under the vehicle. Never place your hand between the extended running board and the vehicle. A moving running board may cause injury.

Working with the engine off

1. Set the parking brake and ensure the gearshift is securely latched in P (Park).
2. Turn off the engine and remove the key.
3. Block the wheels to prevent the vehicle from moving unexpectedly.

Working with the engine on

1. Set the parking brake and shift to P (Park).
2. Block the wheels.



WARNING: To reduce the risk of vehicle damage and/or personal burn injuries, do not start your engine with the air cleaner removed and do not remove it while the engine is running.

Maintenance and Specifications

OPENING THE HOOD

1. Inside the vehicle, pull the hood release handle located under the bottom of the instrument panel.

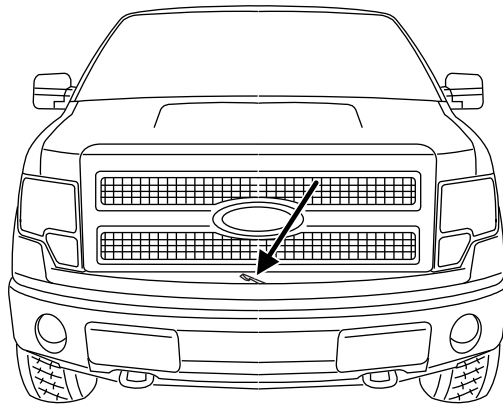
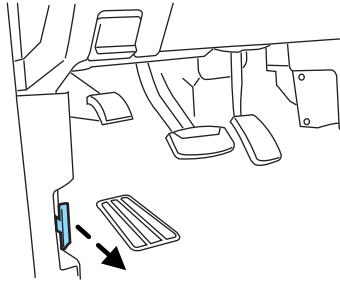

2. Go to the front of the vehicle and release the auxiliary latch that is located on the front bumper under the grill.
3. Lift the hood until the lift cylinders hold it open.

Maintenance and Specifications

IDENTIFYING COMPONENTS IN THE ENGINE COMPARTMENT

4.6L V8

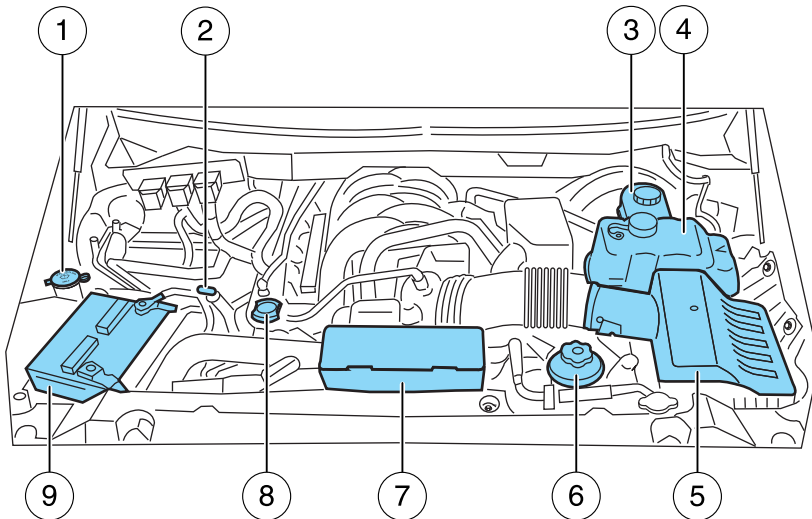

1. Windshield washer fluid reservoir
2. Transmission fluid dipstick (4.6L 2V only)
3. Brake fluid reservoir
4. Engine coolant reservoir
5. Air filter assembly
6. Power steering fluid reservoir
7. Power distribution box
8. Engine oil filler cap
9. Battery

Maintenance and Specifications

5.4L V8

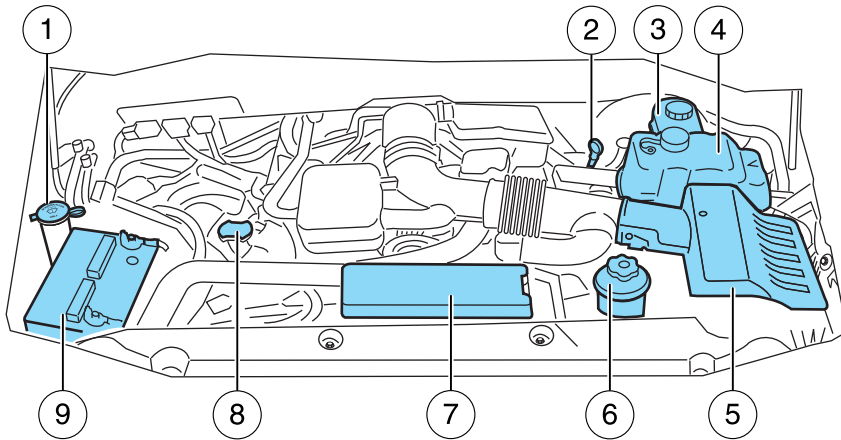

1. Windshield washer fluid reservoir
2. Engine oil dipstick
3. Brake fluid reservoir
4. Engine coolant reservoir
5. Air filter assembly
6. Power steering fluid reservoir
7. Power distribution box
8. Engine oil filler cap
9. Battery

Maintenance and Specifications

WINDSHIELD WASHER FLUID

Add fluid to fill the reservoir if the level is low. In very cold weather, do not fill the reservoir completely.

Only use a washer fluid that meets Ford specification WSB-M8B16-A2. Do not use any special washer fluid such as windshield water repellent type fluid or bug wash. They may cause squeaking, chatter noise, streaking and smearing. Refer to the *Maintenance product specifications and capacities* section in this chapter.

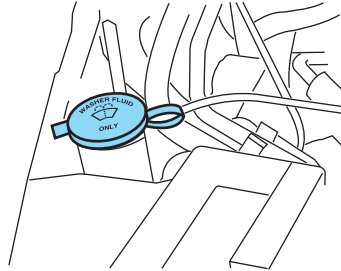

State or local regulations on volatile organic compounds may restrict the use of methanol, a common windshield washer antifreeze additive. Washer fluids containing non-methanol antifreeze agents should be used only if they provide cold weather protection without damaging the vehicle's paint finish, wiper blades or washer system.



WARNING: If you operate your vehicle in temperatures below 40°F (5°C), use washer fluid with antifreeze protection. Failure to use washer fluid with antifreeze protection in cold weather could result in impaired windshield vision and increase the risk of injury or accident.

Note: Do not put washer fluid in the engine coolant reservoir. Washer fluid placed in the cooling system may harm engine and cooling system components.

Maintenance and Specifications

CHANGING THE WIPER BLADES

1. Pull the wiper arm away from the vehicle. Turn the blade at an angle from the wiper arm. Press the lock tab to release the blade and pull the wiper blade down toward the windshield to remove it from the arm.

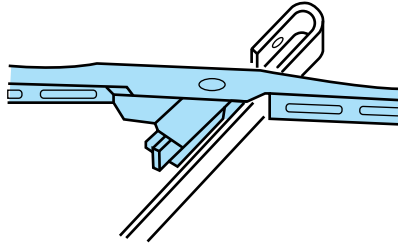

2. Attach the new wiper to the wiper arm and press it into place until a click is heard.

Replace wiper blades at least once per year for optimum performance.

Poor wiper quality can be improved by cleaning the wiper blades and the windshield. Refer to *Windows and wiper blades* in the *Cleaning* chapter.

To prolong the life of the wiper blades, it is highly recommended to scrape off the ice on the windshield before turning on the wipers. The layer of ice has many sharp edges and can damage the micro edge of the wiper rubber element.

ENGINE OIL

Checking the engine oil

Refer to the *scheduled maintenance information* for the appropriate intervals for checking the engine oil.

1. Make sure the vehicle is on level ground.
2. Turn the engine off and wait 15 minutes for the oil to drain into the oil pan.
3. Set the parking brake and ensure the gearshift is securely latched in P (Park).
4. Open the hood. Protect yourself from engine heat.

Maintenance and Specifications

5. Locate and carefully remove the engine oil level dipstick.

6. Wipe the dipstick clean. Insert the dipstick fully, then remove it again.

- If the oil level is **between the lower and upper holes or between the MIN and MAX marks (depending on application)**, the oil level is acceptable. **DO NOT ADD OIL.**

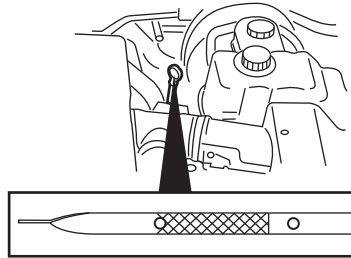

- If the oil level is below the lower hole or the MIN mark, add enough oil to raise the level within the lower and upper holes or within the MIN-MAX range.
 - Oil levels above the upper hole or the MAX mark may cause engine damage. Some oil must be removed from the engine by an authorized dealer.
7. Put the dipstick back in and ensure it is fully seated.

Adding engine oil

1. Check the engine oil. For instructions, refer to *Checking the engine oil* in this chapter.
2. If the engine oil level is not within the normal range, add only certified engine oil of the recommended viscosity. Remove the engine oil filler cap and use a funnel to pour the engine oil into the opening.
3. Recheck the engine oil level. Make sure the oil level is not above the normal operating range on the engine oil level dipstick.
4. Install the dipstick and ensure it is fully seated.
5. Fully install the engine oil filler cap by turning the filler cap clockwise 1/4 of a turn until three clicks are heard or until the cap is fully seated.

To avoid possible oil loss, DO NOT operate the vehicle with the engine oil level dipstick and/or the engine oil filler cap removed.

Maintenance and Specifications

Engine oil and filter recommendations

Look for this certification trademark.

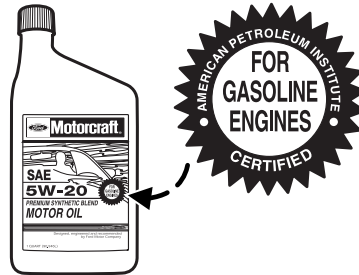

Use SAE 5W-20 engine oil

Only use oils “Certified For Gasoline Engines” by the American Petroleum Institute (API). An oil with this trademark symbol conforms to the current engine and emission system protection standards and fuel economy requirements of the International Lubricant Standardization and Approval Committee (ILSAC), comprised of U.S. and Japanese automobile manufacturers.

To protect your engine and engine’s warranty, use Motorcraft SAE 5W-20 or an equivalent SAE 5W-20 oil meeting Ford specification WSS-M2C930-A. **SAE 5W-20 oil provides optimum fuel economy and durability performance meeting all requirements for your vehicle’s engine.** Refer to *Maintenance product specifications and capacities* later in this chapter for more information.

Do not use supplemental engine oil additives, cleaners or other engine treatments. They are unnecessary and could lead to engine damage that is not covered by Ford warranty.

Change your engine oil and filter according to the appropriate schedule listed in the *scheduled maintenance information*.

Ford production and Motorcraft replacement oil filters are designed for added engine protection and long life. If a replacement oil filter is used that does not meet Ford material and design specifications, start-up engine noises or knock may be experienced.

It is recommended you use the appropriate Motorcraft oil filter or another with equivalent performance for your engine application.

Maintenance and Specifications

BATTERY

Your vehicle is equipped with a Motorcraft maintenance-free battery which normally does not require additional water during its life of service.

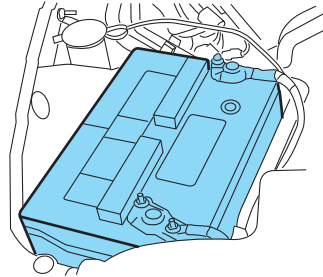

If your battery has a cover/shield, make sure it is reinstalled after the battery has been cleaned or replaced.

For longer, trouble-free operation, keep the top of the battery clean and dry. Also, make certain the battery cables are always tightly fastened to the battery terminals.

If you see any corrosion on the battery or terminals, remove the cables from the terminals and clean with a wire brush. You can neutralize the acid with a solution of baking soda and water.

It is recommended that the negative battery cable terminal be disconnected from the battery if you plan to store your vehicle for an extended period of time. This will minimize the discharge of your battery during storage.

Note: Electrical or electronic accessories or components added to the vehicle by the dealer or the owner may adversely affect battery performance and durability.



WARNING: Batteries normally produce explosive gases which can cause personal injury. Therefore, do not allow flames, sparks or lighted substances to come near the battery. When working near the battery, always shield your face and protect your eyes. Always provide proper ventilation.



WARNING: When lifting a plastic-cased battery, excessive pressure on the end walls could cause acid to flow through the vent caps, resulting in personal injury and/or damage to the vehicle or battery. Lift the battery with a battery carrier or with your hands on opposite corners.

Maintenance and Specifications



WARNING: Keep batteries out of reach of children. Batteries contain sulfuric acid. Avoid contact with skin, eyes or clothing. Shield your eyes when working near the battery to protect against possible splashing of acid solution. In case of acid contact with skin or eyes, flush immediately with water for a minimum of 15 minutes and get prompt medical attention. If acid is swallowed, call a physician immediately.



WARNING: Battery posts, terminals and related accessories contain lead and lead compounds. **Wash hands after handling.**

Battery relearn

Because your vehicle's engine is electronically controlled by a computer, some control conditions are maintained by power from the battery. When the battery is disconnected or a new battery is installed, the engine must relearn its idle and fuel trim strategy for optimum driveability and performance. Flexible fuel vehicles (FFV) must also relearn the ethanol content of the fuel for optimum driveability and performance. To begin this process:

1. With the vehicle at a complete stop, set the parking brake.
2. Put the gearshift in P (Park), turn off all accessories and start the engine.
3. Run the engine until it reaches normal operating temperature.
4. Allow the engine to idle for at least one minute.
5. Turn the A/C on and allow the engine to idle for at least one minute.
6. Release the parking brake. With your foot on the brake pedal and with the A/C on, put the vehicle in D (Drive) and allow the engine to idle for at least one minute.
7. Drive the vehicle to complete the relearning process.
 - The vehicle may need to be driven 10 miles (16 km) or more to relearn the idle and fuel trim strategy along with the ethanol content for flexible fuel vehicles.
 - If you do not allow the engine to relearn its idle trim, the idle quality of your vehicle may be adversely affected until the idle trim is eventually relearned.
 - For flexible fuel vehicles, if you are operating on E85, you may experience poor starts or an inability to start the engine and driveability problems until the fuel trim and ethanol content have been relearned.

Maintenance and Specifications

If the battery has been disconnected or a new battery has been installed, the clock and radio settings must be reset once the battery is reconnected.

- Always dispose of automotive batteries in a responsible manner. Follow your local authorized standards for disposal. Call your local authorized recycling center to find out more about recycling automotive batteries.

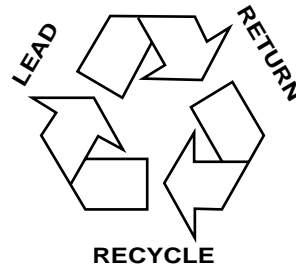

ENGINE COOLANT

Checking engine coolant

The concentration and level of engine coolant should be checked at the intervals listed in *scheduled maintenance information*. The coolant concentration should be maintained at 50/50 coolant and distilled water, which equates to a freeze point of -34°F (-36°C). Coolant concentration testing is possible with a hydrometer or antifreeze tester. The level of coolant should be maintained at the FULL COLD level or within the COLD FILL RANGE in the coolant reservoir. If the level falls below, add coolant per the instructions in the *Adding engine coolant* section.

Your vehicle was factory-filled with a 50/50 engine coolant and water concentration. If the concentration of coolant falls below 40% or above 60%, the engine parts could become damaged or not work properly. **A 50/50 mixture of coolant and water provides the following:**

- **Freeze protection down to -34°F (-36°C).**
- **Boiling protection up to 265°F (129°C).**
- **Protection against rust and other forms of corrosion.**
- **Proper function of calibrated gauges.**

Maintenance and Specifications

When the engine is cold, check the level of the engine coolant in the reservoir.

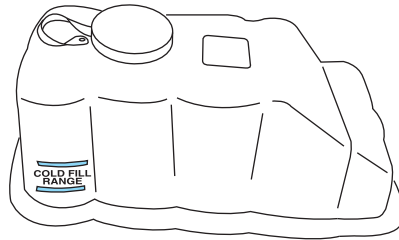

- The engine coolant should be at the FULL COLD level or within the COLD FILL RANGE as listed on the engine coolant reservoir (depending upon application).
- Refer to *scheduled maintenance information* for service interval schedules.
- Be sure to read and understand *Precautions when servicing your vehicle* in this chapter.

If the engine coolant has not been checked at the recommended interval, the engine coolant reservoir may become low or empty. If the reservoir is low or empty, add engine coolant to the reservoir. Refer to *Adding engine coolant* in this chapter.

Note: Automotive fluids are not interchangeable; do not use engine coolant, antifreeze or windshield washer fluid outside of its specified function and vehicle location.

Adding engine coolant

When adding coolant, make sure it is a 50/50 mixture of engine coolant and distilled water. **When the engine is cool**, add the mixture to the coolant reservoir until the appropriate fill level is obtained.



WARNING: Do not add engine coolant when the engine is hot. Steam and scalding liquids released from a hot cooling system can burn you badly. Also, you can be burned if you spill coolant on hot engine parts.



WARNING: Do not put engine coolant in the windshield washer fluid container. If sprayed on the windshield, engine coolant could make it difficult to see through the windshield.

Maintenance and Specifications

- **Add Motorcraft Premium Gold Engine Coolant or equivalent meeting Ford specification WSS-M97B51-A1.** Refer to *Maintenance product specifications and capacities* in this chapter.

Note: Use of Motorcraft Cooling System Stop Leak Pellets or an equivalent product meeting Ford specification WSS-M99B37-B6, may darken the color of Motorcraft Premium Gold Engine Coolant from yellow to golden tan.

- **Do not add/mix an orange-colored, extended life coolant such as Motorcraft Specialty Orange Engine Coolant, meeting Ford specification WSS-M97B44-D, or DEX-COOL® brand with the factory-filled coolant.** Mixing Motorcraft Specialty Orange Engine Coolant or any orange-colored extended life product such as DEX-COOL® brand with your factory filled coolant can result in degraded corrosion protection.
- A large amount of water without engine coolant may be added, in case of emergency, to reach a vehicle service location. In this instance, the cooling system must be drained and refilled with a 50/50 mixture of engine coolant and distilled water as soon as possible. Water alone (without engine coolant) can cause engine damage from corrosion, overheating or freezing.
- **Do not use alcohol, methanol, brine or any engine coolants mixed with alcohol or methanol antifreeze (coolant).** Alcohol and other liquids can cause engine damage from overheating or freezing.
- **Do not add extra inhibitors or additives to the coolant.** These can be harmful and compromise the corrosion protection of the engine coolant.

For vehicles with overflow coolant systems with a non-pressurized cap on the coolant recovery system, add coolant to the coolant recovery reservoir when the engine is cool. Add the proper mixture of coolant and water to the FULL COLD level. For all other vehicles which have a coolant degas system with a pressurized cap, or if it is necessary to remove the coolant pressure relief cap on the radiator of a vehicle with an overflow system, follow these steps to add engine coolant.



WARNING: To reduce the risk of personal injury, make sure the engine is cool before unscrewing the coolant pressure relief cap. The cooling system is under pressure; steam and hot liquid can come out forcefully when the cap is loosened slightly.

Maintenance and Specifications

Add the proper mixture of coolant and water to the cooling system by following these steps:

1. Before you begin, turn the engine off and let it cool.
2. When the engine is cool, wrap a thick cloth around the coolant pressure relief cap on the coolant reservoir (a translucent plastic bottle). Slowly turn cap counterclockwise (left) until pressure begins to release.
3. Step back while the pressure releases.
4. When you are sure that all the pressure has been released, use the cloth to turn it counterclockwise and remove the cap.
5. Fill the coolant reservoir slowly with the proper coolant mixture, to within the COLD FILL RANGE or the FULL COLD level on the reservoir. If you removed the radiator cap in an overflow system, fill the radiator until the coolant is visible and radiator is almost full.
6. Replace the cap. Turn until tightly installed. Cap must be tightly installed to prevent coolant loss.

After any coolant has been added, check the coolant concentration (refer to *Checking engine coolant*). If the concentration is not 50/50 (protection to $-34^{\circ}\text{F}/-36^{\circ}\text{C}$), drain some coolant and adjust the concentration. It may take several drains and additions to obtain a 50/50 coolant concentration.

Whenever coolant has been added, the coolant level in the coolant reservoir should be checked the next few times you drive the vehicle. If necessary, add enough 50/50 concentration of engine coolant and distilled water to bring the liquid level to the proper level.

If you have to add more than 1.0 quart (1.0 liter) of engine coolant per month, have your authorized dealer check the engine cooling system. Your cooling system may have a leak. Operating an engine with a low level of coolant can result in engine overheating and possible engine damage.

Recycled engine coolant

Ford Motor Company does NOT recommend the use of recycled engine coolant since a Ford-approved recycling process is not yet available.



Used engine coolant should be disposed of in an appropriate manner. Follow your community's regulations and standards for recycling and disposing of automotive fluids.

Maintenance and Specifications

Coolant refill capacity

To find out how much fluid your vehicle's cooling system can hold, refer to *Maintenance product specifications and capacities* in this chapter. Fill your engine coolant reservoir as outlined in *Adding engine coolant* in this section.

Severe climates

If you drive in extremely cold climates (less than -34°F [-36°C):

- **It may be necessary to increase the coolant concentration above 50%.**
- **NEVER increase the coolant concentration above 60%.**
- **Increased engine coolant concentrations above 60% will decrease the overheat protection characteristics of the engine coolant and may cause engine damage.**
- **Refer to the chart on the coolant container to ensure the coolant concentration in your vehicle will provide adequate freeze protection at the temperatures in which you drive in the winter months.**

If you drive in extremely hot climates:

- **It is still necessary to maintain the coolant concentration above 40%.**
- **NEVER decrease the coolant concentration below 40%.**
- **Decreased engine coolant concentrations below 40% will decrease the corrosion protection characteristics of the engine coolant and may cause engine damage.**
- **Decreased engine coolant concentrations below 40% will decrease the freeze protection characteristics of the engine coolant and may cause engine damage.**
- **Refer to the chart on the coolant container to ensure the coolant concentration in your vehicle will provide adequate protection at the temperatures in which you drive.**

Vehicles driven year-round in non-extreme climates should use a 50/50 mixture of engine coolant and distilled water for optimum cooling system and engine protection.

What you should know about fail-safe cooling (if equipped)

If the engine coolant supply is depleted, this feature allows the vehicle to be driven temporarily before incremental component damage is incurred. The "fail-safe" distance depends on ambient temperatures, vehicle load and terrain.

Maintenance and Specifications

How fail-safe cooling works

If the engine begins to overheat:

- The engine coolant temperature gauge will move to the red (hot) area.
- The mini message center (if equipped) will indicate “Check Gauges”, refer to *Warning lights and chimes* in the *Instrument Cluster* chapter.
- The  light will illuminate.

If the engine reaches a preset over-temperature condition, the engine will automatically switch to alternating cylinder operation. Each disabled cylinder acts as an air pump and cools the engine.

When this occurs the vehicle will still operate. However:

- The engine power will be limited.
- The air conditioning system will be disabled.

Continued operation will increase the engine temperature:

- The engine will completely shut down.
- Steering and braking effort will increase.

Once the engine temperature cools, the engine can be re-started. Take your vehicle to an authorized dealer as soon as possible to minimize engine damage.

When fail-safe mode is activated

You have limited engine power when in the fail-safe mode, so drive the vehicle with caution. The vehicle will not be able to maintain high speed operation and the engine will run rough. Remember that the engine is capable of completely shutting down automatically to prevent engine damage, therefore:

1. Pull off the road as soon as safely possible and turn off the engine.
2. Arrange for the vehicle to be taken to an authorized dealer.
3. If this is not possible, wait a short period for the engine to cool.
4. Check the coolant level and replenish if low.



WARNING: Never remove the coolant reservoir cap while the engine is running or hot.

5. Restart the engine and take your vehicle to an authorized dealer.

Driving the vehicle without repairing the engine problem increases the chance of engine damage. Take your vehicle to an authorized dealer as soon as possible.

Maintenance and Specifications

FUEL FILTER

Your vehicle is equipped with a lifetime fuel filter that is integrated with the fuel tank. Regular maintenance or replacement is not needed.

WHAT YOU SHOULD KNOW ABOUT AUTOMOTIVE FUELS

Important safety precautions



WARNING: Do not overfill the fuel tank. The pressure in an overfilled tank may cause leakage and lead to fuel spray and fire.



WARNING: The fuel system may be under pressure. If you hear a hissing sound near the fuel filler door (Easy Fuel™ “no cap” fuel system), do not refuel until the sound stops. Otherwise, fuel may spray out, which could cause serious personal injury.



WARNING: Automotive fuels can cause serious injury or death if misused or mishandled.



WARNING: Fuel ethanol and gasoline may contain benzene, which is a cancer-causing agent.

Observe the following guidelines when handling automotive fuel:

- Extinguish all smoking materials and any open flames before fueling your vehicle.
- Always turn off the vehicle before fueling.
- Automotive fuels can be harmful or fatal if swallowed. Fuels such as gasoline and ethanol are highly toxic and if swallowed can cause death or permanent injury. If fuel is swallowed, call a physician immediately, even if no symptoms are immediately apparent. The toxic effects of fuel may not be visible for hours.
- Avoid inhaling fuel vapors. Inhaling too much fuel vapor of any kind can lead to eye and respiratory tract irritation. In severe cases, excessive or prolonged breathing of fuel vapor can cause serious illness and permanent injury.



Maintenance and Specifications

- Avoid getting fuel liquid in your eyes. If fuel is splashed in the eyes, remove contact lenses (if worn), flush with water for 15 minutes and seek medical attention. Failure to seek proper medical attention could lead to permanent injury.
- Fuels can also be harmful if absorbed through the skin. If fuel is splashed on the skin and/or clothing, promptly remove contaminated clothing and wash skin thoroughly with soap and water. Repeated or prolonged skin contact with fuel liquid or vapor causes skin irritation.
- Be particularly careful if you are taking “Antabuse” or other forms of disulfiram for the treatment of alcoholism. Breathing gasoline and/or ethanol vapors, or skin contact could cause an adverse reaction. In sensitive individuals, serious personal injury or sickness may result. If fuel is splashed on the skin, promptly wash skin thoroughly with soap and water. Consult a physician immediately if you experience an adverse reaction.
- FFV fuel tanks may contain zero to 85 percent ethanol. Any fuel blends containing gasoline and ethanol should be treated the same as “Fuel Ethanol.” Flex fuel vehicles have a yellow bezel placed over the fuel fill inlet.

Pure ethanol is the alcohol which is the intoxicating agent in liquor, beer and wine. It is distilled from the fermentation of plants such as field corn and sugar cane. When ethanol is produced for use in motor fuels, a small amount of gasoline is added to make it unfit for beverage use. The resulting ethanol blend is called denatured fuel ethanol meaning that it is denatured with 2% to 5% gasoline and is suitable for automotive use.

During the summer season, fuel ethanol may contain a maximum of 85% denatured ethanol (Ed85) and 15% unleaded gasoline. The fuel ethanol has a higher octane rating than unleaded regular or premium gasoline and this allows the design of engines with greater efficiency and power.

Winter blends may contain up to 75% denatured ethanol (Ed75) and up to 25% unleaded gasoline to enhance cold engine starts. Severely cold weather may require additional measures for reliable starting.

Ethanol is more chemically active than gasoline. It corrodes some metals and causes some plastic and rubber components to swell, break down or become brittle and crack, especially when mixed with gasoline. Special materials and procedures have been developed for flexible fuel vehicles and the dispensers used by ethanol fuel providers.

Maintenance and Specifications

 **WARNING:** Flexible fuel components and standard unleaded gasoline fuel components are not interchangeable. If your vehicle is not serviced in accordance with flexible fuel vehicles procedures, damage may occur and your warranty may be invalidated.

 **WARNING:** When refueling always shut the engine off and never allow sparks or open flames near the filler neck. Never smoke while refueling. Fuel vapor is extremely hazardous under certain conditions. Care should be taken to avoid inhaling excess fumes.

 **WARNING:** The flow of fuel through a fuel pump nozzle can produce static electricity, which can cause a fire if fuel is pumped into an ungrounded fuel container.

Refueling

 **WARNING:** Fuel vapor burns violently and a fuel fire can cause severe injuries. To help avoid injuries to you and others:

- Read and follow all the instructions on the pump island;
- Turn off your engine when you are refueling;
- Do not smoke if you are near fuel or refueling your vehicle;
- Keep sparks, flames and smoking materials away from fuel;
- Stay outside your vehicle and do not leave the fuel pump unattended when refueling your vehicle — this is against the law in some places;
- Keep children away from the fuel pump; never let children pump fuel.

Use the following guidelines to avoid electrostatic charge build-up when filling an ungrounded fuel container:

- Place approved fuel container on the ground.
- DO NOT fill a fuel container while it is in the vehicle (including the cargo area).
- Keep the fuel pump nozzle in contact with the fuel container while filling.
- DO NOT use a device that would hold the fuel pump handle in the fill position.

Maintenance and Specifications

Easy Fuel™ “no cap” fuel system

Your fuel tank is equipped with an Easy Fuel™ “no cap” fuel filler system. This allows you to simply open the fuel filler door and insert the fuel filler nozzle into the fuel system. The Easy Fuel™ system is self-sealing and protected against dust, dirt, water and snow/ice.

When fueling your vehicle:

1. Turn the engine off.
2. Open the fuel filler door.
3. Slowly insert the fuel filler nozzle fully into the fuel system. Pump fuel as normal.
4. After you are done pumping fuel, slowly remove the fuel filler nozzle—allow about five seconds after pumping fuel before removing the fuel filler nozzle. This allows residual fuel to drain back into the fuel tank and not spill onto the vehicle.

Note: A fuel spillage concern may occur if overfilling the fuel tank. Do not overfill the tank to the point that the fuel is able to bypass the fuel filler nozzle. The overfilled fuel may run down the drain located below and in front of the fuel filler door.

If the Check Fuel Fill Inlet lamp or Check Fuel Fill Inlet message comes on, the fuel fill inlet may not have properly closed. The inlet may have stuck open or debris may be preventing the inlet from fully closing. At the next opportunity, safely pull off the road, turn off the engine, open the fuel filler door and remove any visible debris from the fuel fill opening. Insert either the fuel fill nozzle or the fuel fill funnel (see *Refilling with a portable fuel container* for funnel location) provided with the vehicle several times to dislodge any debris and/or allow the inlet to close properly. If this action corrects the problem, the Check Fuel Fill Inlet lamp or Check Fuel Fill Inlet message may not reset immediately. It may take several driving cycles for the Check Fuel Fill Inlet lamp or Check Fuel Fill Inlet message to turn off. A driving cycle consists of an engine start-up (after four or more hours with the engine off) followed by city/highway driving. Continuing to drive with the Check Fuel Fill Inlet lamp or Check Fuel Fill Inlet message on may cause the Service Engine Soon lamp to turn on as well.



WARNING: The fuel system may be under pressure. If you hear a hissing sound near the fuel filler door (Easy Fuel™ “no cap” fuel system), do not refuel until the sound stops. Otherwise, fuel may spray out, which could cause serious personal injury.

Maintenance and Specifications

Flex Fuel Vehicle (FFV) fuel fill inlet

Flex fuel vehicles have a yellow bezel placed over the fuel fill inlet.

FORD RECOMMENDS BP



Choosing the right fuel

If your vehicle is a flexible fuel vehicle (FFV), use only UNLEADED FUEL and FUEL ETHANOL (Ed75–Ed85).

If your vehicle is not a flexible fuel vehicle (FFV), then only use UNLEADED fuel or UNLEADED fuel blended with a maximum of 10% ethanol. Do not use fuel ethanol (E85), diesel, methanol, leaded fuel or any other fuel.

The use of leaded fuel is prohibited by law and could damage your vehicle.

Your vehicle was not designed to use fuel or fuel additives with metallic compounds, including manganese-based additives.

Note: Use of any fuel other than those recommended may cause powertrain damage, a loss of vehicle performance, and repairs may not be covered under warranty.

Cleaner air

Ford endorses the use of reformulated “cleaner-burning” gasolines to improve air quality, per the recommendations in the *Choosing the right fuel* section.

Maintenance and Specifications

Octane recommendations

Do not be concerned if your engine sometimes knocks lightly. However, if it knocks heavily under most driving conditions while you are using fuel with the recommended octane rating, see your authorized dealer to prevent any engine damage.

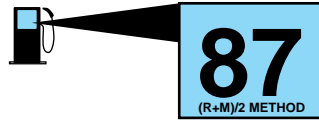

Unleaded Gasoline Engines

Your vehicle is designed to use “Regular” unleaded gasoline with a pump (R+M)/2 octane rating of 87. We do not recommend the use of gasolines labeled as “Regular” in high altitude areas that are sold with octane ratings less than 87.

FFV engine

Your vehicle is designed to use Fuel Ethanol (Ed75–Ed85), “Regular” unleaded gasoline or any mixture of the two fuels.

Use of other fuels such as Fuel Methanol may cause powertrain damage, a loss of vehicle performance, and your warranty may be invalidated.

Fuel quality

Do not add aftermarket fuel additive products to your fuel tank. It should not be necessary to add any aftermarket products to your fuel tank if you continue to use high quality fuel of the recommended octane rating. These products have not been approved for your engine and could cause damage to the fuel system. Repairs to correct the effects of using an aftermarket product in your fuel may not be covered by your warranty.

Many of the world’s automakers approved the World-Wide Fuel Charter that recommends gasoline specifications to provide improved performance and emission control system protection for your vehicle. Gasolines that meet the World-Wide Fuel Charter should be used when available. Ask your fuel supplier about gasolines that meet the World-Wide Fuel Charter.

Unleaded gasoline engines

If you are experiencing starting, rough idle or hesitation driveability problems during a cold start, try a different brand of “Regular” unleaded gasoline. “Premium” unleaded gasoline is not recommended for vehicles designed to use “Regular” unleaded gasoline because it may cause these problems to become more pronounced. If the problems persist, see your authorized dealer.

Maintenance and Specifications

FFV engine

Flex fuel vehicles have a yellow bezel around the fuel fill inlet.

It is best not to alternate repeatedly between gasoline and E85. If you do switch fuels, it is recommended that you add as much fuel as possible—at least half a tank. Do not add less than five gallons (18.9L) when refueling. You should drive the vehicle immediately after refueling for at least 5 miles (8 km) to allow the vehicle to adapt to the change in ethanol concentration.

If you operate your vehicle 50% or more of the time on ethanol, you should follow a different maintenance schedule. In addition to this, it is also recommended to fill the fuel tank with regular unleaded gasoline once every 3,000 miles (4,800 km). See *scheduled maintenance information* for more information.

Running out of fuel

Avoid running out of fuel because this situation may have an adverse effect on powertrain components.

If you have run out of fuel:

- You may need to cycle the ignition from off to on several times after refueling to allow the fuel system to pump the fuel from the tank to the engine. On restarting, cranking time will take a few seconds longer than normal.
- Normally, adding 1 gallon (3.8L) of fuel is enough to restart the engine. If the vehicle is out of fuel and on a steep grade, more than 1 gallon (3.8L) may be required.
- The service engine soon  indicator may come on. For more information on the service engine soon indicator, refer to *Warning lights and chimes* in the *Instrument Cluster* chapter.

Refilling with a portable fuel container

With the Easy Fuel™ “no cap” fuel system, use the following directions when filling from a portable fuel container:



WARNING: Do not insert the nozzle of portable fuel containers or aftermarket funnels into the Easy Fuel™ system. This could damage the fuel system and its seal, and may cause fuel to run onto the ground instead of filling the tank, which could result in serious personal injury.

Maintenance and Specifications



WARNING: Do not try to pry open or push open the Easy Fuel™ system with foreign objects. This could damage the fuel system and its seal and cause injury to you or others.

When filling the vehicle's fuel tank from a portable fuel container, use the funnel included with the vehicle.

1. Locate the white plastic funnel. It is located under the second row driver side seat near the spare tire tool box.

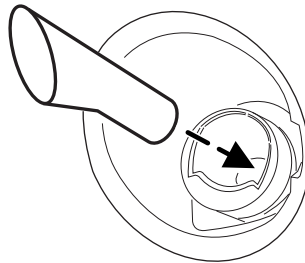

2. Slowly insert the funnel into the Easy Fuel™ system.
3. Fill the vehicle with fuel from the portable fuel container.
4. When done, clean the funnel or properly dispose of it. Extra funnels can be purchased from your authorized dealer if you choose to dispose of the funnel. **Do not** use aftermarket funnels; they will not work with the Easy Fuel™ system and can damage it. The included funnel has been specially designed to work safely with your vehicle.

ESSENTIALS OF GOOD FUEL ECONOMY

Measuring techniques

Your best source of information about actual fuel economy is you, the driver. You must gather information as accurately and consistently as possible. Fuel expense, frequency of fill-ups or fuel gauge readings are NOT accurate as a measure of fuel economy. We do not recommend taking fuel economy measurements during the first 1,000 miles (1,600 km) of driving (engine break-in period). You will get a more accurate measurement after 2,000 miles–3,000 miles (3,000 km–5,000 km).

Filling the tank

The advertised fuel capacity of the fuel tank on your vehicle is equal to the rated refill capacity of the fuel tank as listed in the *Maintenance product specifications and capacities* section of this chapter.

Maintenance and Specifications

The advertised capacity is the amount of the indicated capacity and the empty reserve combined. Indicated capacity is the difference in the amount of fuel in a full tank and a tank when the fuel gauge indicates empty. Empty reserve is the small amount of fuel remaining in the fuel tank after the fuel gauge indicates empty.

The amount of usable fuel in the empty reserve varies and should not be relied upon to increase driving range. When refueling your vehicle after the fuel gauge indicates empty, you might not be able to refuel the full amount of the advertised capacity of the fuel tank due to the empty reserve still present in the tank.

For consistent results when filling the fuel tank:

- Turn the engine/ignition switch to the off position prior to refueling, an error in the reading may result if the engine is left running.
- Use the same filling rate setting (low — medium — high) each time the tank is filled.
- Allow no more than three automatic click-offs when filling.
- Always use fuel with the recommended octane rating.
- Use a known quality gasoline, preferably a national brand.
- Use the same side of the same pump and have the vehicle facing the same direction each time you fill up.
- Have the vehicle loading and distribution the same every time.

Your results will be most accurate if your filling method is consistent.

Calculating fuel economy

1. Fill the fuel tank completely and record the initial odometer reading (in miles or kilometers).
2. Each time you fill the tank, record the amount of fuel added (in gallons or liters).
3. After at least three to five tank fill-ups, fill the fuel tank and record the current odometer reading.
4. Subtract your initial odometer reading from the current odometer reading.
5. Follow one of the simple calculations in order to determine fuel economy:

Calculation 1: **Divide total miles traveled by total gallons used.**

Calculation 2: **Multiply liters used by 100, then divide by total kilometers traveled.**

Maintenance and Specifications

Keep a record for at least one month and record the type of driving (city or highway). This will provide an accurate estimate of the vehicle's fuel economy under current driving conditions. Additionally, keeping records during summer and winter will show how temperature impacts fuel economy. In general, lower temperatures give lower fuel economy.

Driving style — good driving and fuel economy habits

Give consideration to the lists that follow and you may be able to change a number of variables and improve your fuel economy.

Habits

- Smooth, moderate operation can yield up to 10% savings in fuel.
- Steady speeds without stopping will usually give the best fuel economy.
- Idling for long periods of time (greater than one minute) may waste fuel.
- Anticipate stopping; slowing down may eliminate the need to stop.
- Sudden or hard accelerations may reduce fuel economy.
- Slow down gradually.
- Driving at reasonable speeds (traveling at 55 mph [88 km/h] uses 15% less fuel than traveling at 65 mph [105 km/h]).
- Revving the engine before turning it off may reduce fuel economy.
- Using the air conditioner or defroster may reduce fuel economy.
- You may want to turn off the speed control in hilly terrain if unnecessary shifting between the top gears occurs. Unnecessary shifting of this type could result in reduced fuel economy.
- Warming up a vehicle on cold mornings is not required and may reduce fuel economy.
- Resting your foot on the brake pedal while driving may reduce fuel economy.
- Combine errands and minimize stop-and-go driving.

Maintenance

- Keep tires properly inflated and use only recommended size.
- Operating a vehicle with the wheels out of alignment will reduce fuel economy.
- Use recommended engine oil. Refer to *Maintenance product specifications and capacities* in this chapter.

Maintenance and Specifications

- Perform all regularly scheduled maintenance items. Follow the recommended maintenance schedule and owner maintenance checks found in *scheduled maintenance information*.

Conditions

- Heavily loading a vehicle or towing a trailer may reduce fuel economy at any speed.
- Carrying unnecessary weight may reduce fuel economy (approximately 1 mpg [0.4 km/L] is lost for every 400 lb [180 kg] of weight carried).
- Adding certain accessories to your vehicle (for example bug deflectors, rollbars/light bars, running boards, ski/luggage racks) may reduce fuel economy.
- To maximize the fuel economy, drive with the tonneau cover installed (if equipped).
- Using fuel blended with alcohol may lower fuel economy.
- Fuel economy may decrease with lower temperatures during the first 8–10 miles (12–16 km) of driving.
- Driving on flat terrain offers improved fuel economy as compared to driving on hilly terrain.
- Transmissions give their best fuel economy when operated in the top cruise gear and with steady pressure on the gas pedal.
- Four-wheel-drive operation (if equipped) is less fuel efficient than two-wheel-drive operation.
- Close windows for high speed driving.

EPA fuel economy estimates

Every new vehicle should have a window sticker containing EPA fuel economy estimates. Contact your authorized dealer if the window sticker is not supplied with your vehicle. The EPA fuel economy estimates should be your guide for the fuel economy comparisons with other vehicles. Your fuel economy may vary depending upon the method of operation and conditions.

Maintenance and Specifications

EMISSION CONTROL SYSTEM

Your vehicle is equipped with various emission control components and a catalytic converter which will enable your vehicle to comply with applicable exhaust emission standards. To make sure that the catalytic converter and other emission control components continue to work properly:

- Use only the specified fuel listed.
- Avoid running out of fuel.
- Do not turn off the ignition while your vehicle is moving, especially at high speeds.
- Have the items listed in *scheduled maintenance information* performed according to the specified schedule.

The scheduled maintenance items listed in *scheduled maintenance information* are essential to the life and performance of your vehicle and to its emissions system.

If other than Ford, Motorcraft or Ford-authorized parts are used for maintenance replacements or for service of components affecting emission control, such non-Ford parts should be equivalent to genuine Ford Motor Company parts in performance and durability.



WARNING: Do not park, idle, or drive your vehicle in dry grass or other dry ground cover. The emission system heats up the engine compartment and exhaust system, which can start a fire.

Illumination of the service engine soon  indicator, charging system warning light or the temperature warning light, fluid leaks, strange odors, smoke or loss of engine power could indicate that the emission control system is not working properly.

An improperly operating or damaged exhaust system may allow exhaust to enter the vehicle. Have a damaged or improperly operating exhaust system inspected and repaired immediately.



WARNING: Exhaust leaks may result in entry of harmful and potentially lethal fumes into the passenger compartment.



Do not make any unauthorized changes to your vehicle or engine. By law, vehicle owners and anyone who manufactures, repairs, services, sells, leases, trades vehicles, or supervises a fleet of vehicles are not permitted to intentionally remove an emission control device or prevent

Maintenance and Specifications

it from working. Information about your vehicle's emission system is on the Vehicle Emission Control Information Decal located on or near the engine. This decal also lists engine displacement.



Please consult your *Warranty Guide/Customer Information Guide* for complete emission warranty information.

On board diagnostics (OBD-II)

Your vehicle is equipped with a computer that monitors the engine's emission control system. This system is commonly known as the On Board Diagnostics System (OBD-II). The OBD-II system protects the environment by ensuring that your vehicle continues to meet government emission standards. The OBD-II system also assists your authorized dealer in properly servicing your vehicle. When the service engine soon  indicator illuminates, the OBD-II system has detected a malfunction. Temporary malfunctions may cause the service engine soon  indicator to illuminate. Examples are:

1. The vehicle has run out of fuel—the engine may misfire or run poorly.
2. Poor fuel quality or water in the fuel—the engine may misfire or run poorly.
3. The fuel fill inlet may not have been properly closed. See *Easy Fuel™ “no cap” fuel system* in this chapter.
4. Driving through deep water—the electrical system may be wet.

These temporary malfunctions can be corrected by filling the fuel tank with good quality fuel, properly closing the fuel fill inlet or letting the electrical system dry out. After three driving cycles without these or any other temporary malfunctions present, the service engine soon  indicator should stay off the next time the engine is started. A driving cycle consists of a cold engine startup followed by mixed city/highway driving. No additional vehicle service is required.



If the service engine soon  indicator remains on, have your vehicle serviced at the first available opportunity. Although some malfunctions detected by the OBD-II may not have symptoms that are apparent, continued driving with the service engine soon  indicator on can result in increased emissions, lower fuel economy, reduced engine and transmission smoothness, and lead to more costly repairs.

Maintenance and Specifications

Readiness for Inspection/Maintenance (I/M) testing

Some state/provincial and local governments may have Inspection/Maintenance (I/M) programs to inspect the emission control equipment on your vehicle. Failure to pass this inspection could prevent you from getting a vehicle registration. Your vehicle may not pass the I/M test if the service engine soon  indicator is on or not working properly (bulb is burned out), or if the OBD-II system has determined that some of the emission control systems have not been properly checked. In this case, the vehicle is considered not ready for I/M testing.

If the service engine soon  indicator is on or the bulb does not work, the vehicle may need to be serviced. Refer to the On board diagnostics (OBD-II) description in this chapter.

If the vehicle's engine or transmission has just been serviced, or the battery has recently run down or been replaced, the OBD-II system may indicate that the vehicle is not ready for I/M testing. To determine if the vehicle is ready for I/M testing, turn the ignition key to the on position for 15 seconds without cranking the engine. If the service engine soon  indicator blinks eight times, it means that the vehicle is not ready for I/M testing; if the service engine soon  indicator stays on solid, it means that the vehicle is ready for I/M testing.

The OBD-II system is designed to check the emission control system during normal driving. A complete check may take several days. If the vehicle is not ready for I/M testing, the following driving cycle consisting of mixed city and highway driving may be performed:

15 minutes of steady driving on an expressway/highway followed by 20 minutes of stop-and-go driving with at least four 30-second idle periods.

Allow the vehicle to sit for at least eight hours without starting the engine. Then, start the engine and complete the above driving cycle. The engine must warm up to its normal operating temperature. Once started, do not turn off the engine until the above driving cycle is complete. If the vehicle is still not ready for I/M testing, the above driving cycle will have to be repeated.

POWER STEERING FLUID

Check the power steering fluid. Refer to *scheduled maintenance information*.

Maintenance and Specifications

1. Start the engine and let it run until it reaches normal operating temperature (the engine coolant temperature gauge indicator will be near the center of the normal area between H and C).

2. While the engine idles, turn the steering wheel left and right several times.

3. Turn the engine off.

4. Check the fluid level in the reservoir. It should be between the MIN and MAX lines. Do not add fluid if the level is in this range.

5. If the fluid is low, add fluid in small amounts, continuously checking the level until it reaches the range between the MIN and MAX lines. Be sure to put the cap back on the reservoir. Refer to *Maintenance product specifications and capacities* in this chapter for the proper fluid type.

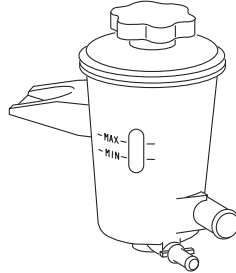

BRAKE FLUID

The fluid level will drop slowly as the brakes wear, and will rise when the brake components are replaced. Fluid levels between the “MIN” and “MAX” lines are within the normal operating range; there is no need to add fluid. If the fluid levels are outside of the normal operating range the performance of the system could be compromised; seek service from your authorized dealer immediately.

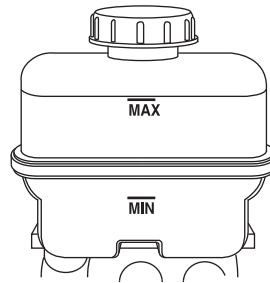

TRANSMISSION FLUID

Checking 4-speed automatic transmission fluid

Refer to your *scheduled maintenance information* for scheduled intervals for fluid checks and changes. Your transmission does not consume fluid. However, the fluid level should be checked if the transmission is not working properly, i.e., if the transmission slips or shifts slowly or if you notice some sign of fluid leakage.

Maintenance and Specifications

Automatic transmission fluid expands when warmed. To obtain an accurate fluid check, drive the vehicle until it is at normal operating temperature (approximately 20 miles [30 km]). If your vehicle has been operated for an extended period at high speeds, in city traffic during hot weather or pulling a trailer, the vehicle should be turned off for about 30 minutes to allow fluid to cool before checking.

1. Drive the vehicle 20 miles (30 km) or until it reaches normal operating temperature.
2. Park the vehicle on a level surface and engage the parking brake.
3. With the parking brake engaged and your foot on the brake pedal, start the engine and move the gearshift lever through all of the gear ranges. Allow sufficient time for each gear to engage.
4. Latch the gearshift lever in P (Park) and leave the engine running.
5. Remove the dipstick, wiping it clean with a clean, dry lint free rag. If necessary, refer to *Identifying components in the engine compartment* in this chapter for the location of the dipstick.
6. Install the dipstick making sure it is fully seated in the filler tube.
7. Remove the dipstick and inspect the fluid level. The fluid should be in the designated area for normal operating temperature or ambient temperature.

Low fluid level

Do not drive the vehicle if the fluid level is at the bottom of the dipstick and the ambient temperature is above 50°F (10°C).



Correct fluid level

The transmission fluid should be checked at normal operating temperature 150°F-170°F (66°C-77°C) on a level surface. The normal operating temperature can be reached after approximately 20 miles (30 km) of driving.

You can check the fluid without driving if the ambient temperature is above 50°F (10°C). However, if fluid is added at this time, an overfill condition could result when the vehicle reaches normal operating temperature.

Maintenance and Specifications

The transmission fluid should be in this range if at normal operating temperature (150°F-170°F [66°C-77°C]).

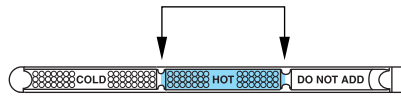

The transmission fluid should be in this range if at ambient temperature (50°F-95°F [10°C-35°C]).

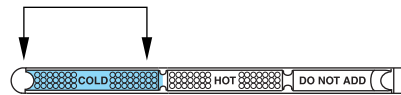

High fluid level

Fluid levels above the safe range may result in transmission failure. An overfill condition of transmission fluid may cause shift and/or engagement concerns and/or possible damage.



High fluid levels can be caused by an overheating condition.

Adjusting automatic transmission fluid levels

Before adding any fluid, make sure the correct type is used. The type of fluid used is normally indicated on the dipstick. Refer to *Maintenance product specifications and capacities* in this chapter.

Use of a non-approved automatic transmission fluid may cause internal transmission component damage.

If necessary, add fluid in 1/2 pint (250 ml) increments through the filler tube until the level is correct.

If an overfill occurs, excess fluid should be removed by an authorized dealer.



An overfill condition of transmission fluid may cause shift and/or engagement concerns and/or possible damage.

Do not use supplemental transmission fluid additives, treatments or cleaning agents. The use of these materials may affect transmission operation and result in damage to internal transmission components.

Maintenance and Specifications

Checking 6-speed automatic transmission fluid

The automatic transmission does not have a transmission fluid dipstick.

Refer to your *scheduled maintenance information* for scheduled intervals for fluid checks and changes. Your transmission does not consume fluid. However, the fluid level should be checked if the transmission is not working properly, (i.e., if the transmission slips or shifts slowly) or if you notice some sign of fluid leakage.

Transmission fluid should be checked by an authorized dealer. If required, fluid should be added by an authorized dealer.

Do not use supplemental transmission fluid additives, treatments or cleaning agents. The use of these materials may affect transmission operation and result in damage to internal transmission components.

TRANSFER CASE FLUID (IF EQUIPPED)

1. Clean the filler plug.
2. Remove the filler plug and inspect the fluid level.

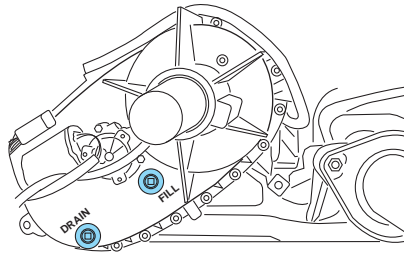

3. Add only enough fluid through the filler opening so that the fluid level is at the bottom of the opening.

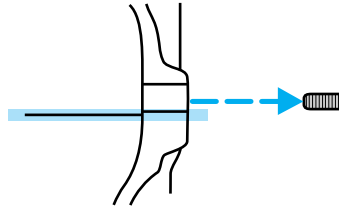

Use only fluid that meets Ford specifications. Refer to the *Maintenance product specifications and capacities* section in this chapter.

Maintenance and Specifications

AIR FILTER

Refer to *scheduled maintenance information* for the appropriate intervals for changing the air filter element.

When changing the air filter element, use only the air filter element listed. Refer to *Motorcraft part numbers* in this chapter.



WARNING: To reduce the risk of vehicle damage and/or personal burn injuries do not start your engine with the air cleaner removed and do not remove it while the engine is running.

Changing the air filter element

1. Locate the mass air flow sensor electrical connector on the air outlet tube. This connector will need to be unplugged.

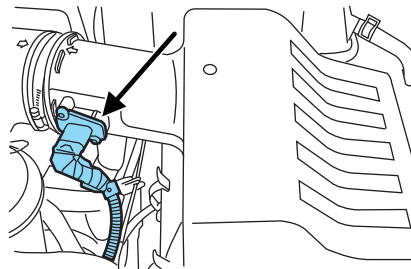

2. Reposition the locking clip on the connector (connector shown from below for clarity), squeeze the connector and pull it off of the air outlet tube.

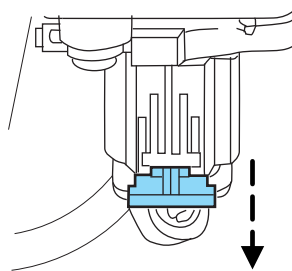

Maintenance and Specifications

3. Clean the area around the air tube to air cover connection to prevent debris from entering the system and then loosen the bolt on the air tube clamp so the clamp is no longer snug to the air tube. It is not necessary to completely remove the clamp.

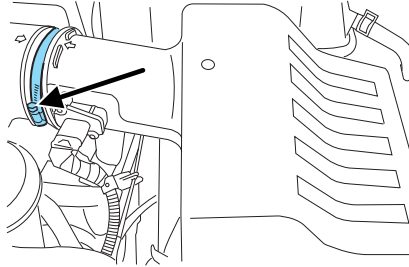

4. Pull the air tube off from the air cleaner housing.

5. Release the three clamps that secure the cover to the air filter housing. Push the air filter cover toward the center of the vehicle and up slightly to release it.

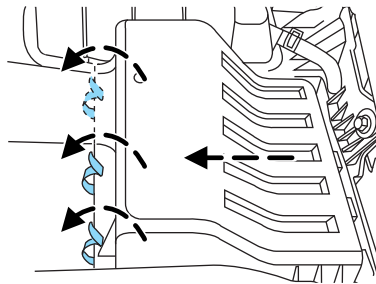

6. Remove the air filter element from the air filter housing.

7. Install a new air filter element.

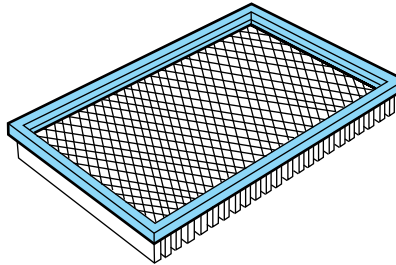

Maintenance and Specifications

8. Replace the air filter housing cover and secure the clamps. Be careful not to crimp the filter element edges between the air filter housing and cover and ensure that the tabs on the edge are properly aligned into the slots.

9. Slip the air tube onto the air filter housing and tighten the air-tube clamp bolt snugly, but do not overtighten it.

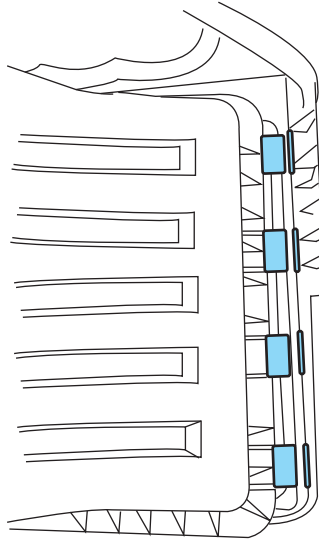

10. Reconnect the mass air flow sensor electrical connector to the outlet tube. Make sure the locking tab on the connector is in the “locked” position (connector shown from below for clarity).

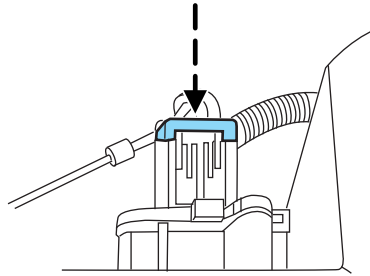

Note: Failure to use the correct air filter element may result in severe engine damage. The customer warranty may be void for any damage to the engine if the correct air filter element is not used.

Maintenance and Specifications

MOTORCRAFT PART NUMBERS

Component	4.6L 2V V8 engine	4.6L 3V V8 engine	5.4L V8 engine
Air filter element	FA-1883	FA-1883	FA-1883
Battery	BTX-59 or BTX-65-650 ³	BTX-59 or BTX-65-650 ³	BTX-59 or BTX-65-650 ³
Oil Filter	FL-820-S	FL-820-S	FL-820-S
PCV valve	¹		
Spark plugs	²		

¹The PCV valve is a critical emission component. It is one of the items listed in *scheduled maintenance information* and is essential to the life and performance of your vehicle and to its emissions system.

For PCV valve replacement, see your authorized dealer. Refer to *scheduled maintenance information* for the appropriate intervals for changing the PCV valve.

Replace the PCV valve with one that meets Ford material and design specifications for your vehicle, such as a Motorcraft or equivalent replacement part. The customer warranty may be void for any damage to the emissions system if such a PCV valve is not used.

²For spark plug replacement, see your authorized dealer. Refer to *scheduled maintenance information* for the appropriate intervals for changing the spark plugs.

Replace the spark plugs with ones that meet Ford material and design specifications for your vehicle, such as Motorcraft or equivalent replacement parts. The customer warranty may be void for any damage to the engine if such spark plugs are not used.

³Heavy-duty battery, if equipped.

Maintenance and Specifications

MAINTENANCE PRODUCT SPECIFICATIONS AND CAPACITIES

Item	Capacity	Ford part name or equivalent	Ford part number / Ford specification
Brake fluid	Between MIN/MAX on brake fluid reservoir	Motorcraft High Performance DOT 3 Motor Vehicle Brake Fluid	PM-1-C / WSS-M6C62-A or WSS-M6C65-A1
4.6L engine oil	6.0 quarts (5.7L)	Motorcraft SAE 5W-20 Premium Synthetic Blend Motor Oil (US) Motorcraft SAE 5W-20 Super Premium Motor Oil (Canada) ¹	XO-5W20-QSP (US) CXO-5W20-LSP12 (Canada) / WSS-M2C930-A and API Certification Mark
5.4L engine oil	7.0 quarts (6.6L)		
4.6L 2V engine coolant	16.4 quarts (15.5L)	Motorcraft Premium Gold Engine Coolant with bittering agent (yellow-colored) ²	VC-7-B / WSS-M97B51-A1
4.6L 3V engine coolant	15.8 quarts (15.0L)		
5.4L engine coolant	16.9 quarts (16.0L)		
Cooling system stop leak pellets	—	Motorcraft Cooling System Stop Leak Pellets	VC-6 / WSS-M99B37-B6

<https://www.MyCarManual.com>

Maintenance and Specifications

Item	Capacity	Ford part name or equivalent	Ford part number / Ford specification
Front axle (4X4)	3.5 pints (1.8L)	Motorcraft SAE 80W-90 Premium Rear Axle Lubricant	XY-80W-90-QL / WSP-M2C197-A
Rear 8.8/9.75 inch axle fluid	5.5 pints (2.6L) ³	Motorcraft SAE 75W-140 Rear Synthetic Axle Lubricant ⁵	XY-75W140-QL / WSL-M2C192-A
Transmission /steering/parking brake linkages and pivots, brake pedal shaft	—	Premium Long-Life Grease	XG-1-C / ESA-M1C75-B
Hinges, latches, striker plates, seat tracks, fuel filler door hinge and door check arm	—	Motorcraft Multi-Purpose Grease	XG-4 or XL-5 / ESB-M1C93-B
Power steering fluid	Fill to between MIN and MAX lines on reservoir	Motorcraft MERCON® V ATF	XT-5-QM / MERCON® V
Transfer case fluid (4X4 / AWD)	1.6 quarts (1.5L) ⁶	Motorcraft Transfer Case Fluid	XL-12 / —

Maintenance and Specifications

Item	Capacity	Ford part name or equivalent	Ford part number / Ford specification
Automatic transmission fluid (4R75E)	13.9 quarts (13.2L) ⁷	Motorcraft MERCON® LV ATF ⁸	XT-10-QLV / MERCON® LV
Automatic transmission fluid (6R80)	13.9 quarts (13.2L) ⁷	Motorcraft MERCON® LV ATF ⁸	XT-10-QLV / MERCON® LV
Windshield washer fluid	4.25 quarts (4.0L)	Motorcraft Premium Windshield Washer Concentrate	ZC-32-A / WSB-M8B16-A2
Fuel tank Reg. Cab 6.5' box / SuperCab 5.5' box	26.0 gallons (98.4L)	—	—
Fuel tank Crew Cab 5.5' box	26.0 gallons (98.4L) Standard 36.0 gallons (136.2L) Optional	—	—
Fuel tank Crew Cab 6.5' box	26.0 gallons (98.4L) Standard 36.0 gallons (136.2L) Optional	—	—

Maintenance and Specifications

Item	Capacity	Ford part name or equivalent	Ford part number / Ford specification
Fuel tank Reg. Cab 8' box / SuperCab 6.5' box / SuperCab 8' box	26.0 gallons (98.4L) Standard 36.0 gallons (136.2L) Optional	—	—

¹Use of synthetic or synthetic blend motor oil is not mandatory. Engine oil need only meet the requirements of Ford specification WSS-M2C930-A and the API Certification mark.

²Add the coolant type originally equipped in your vehicle.

³Service refill capacity is determined by filling the axle to 1/4-9/16 inch (6-14 mm) below the bottom of the filler hole with the vehicle on a level surface.

Add 4 oz. (118 ml) of Additive Friction Modifier XL-3 or equivalent meeting Ford specification EST-M2C118-A, for complete fill of 8.8 inch and 9.75 inch Traction-Lok axles.

⁴Service refill capacity is determined by filling the axle to the bottom of the filler hole with the vehicle on a level surface.

⁵Your vehicle's rear axle is filled with a synthetic rear axle lubricant and is considered lubricated for life. These lubricants do not need to be checked or changed unless a leak is suspected, service is required or the axle assembly has been submerged in water. The axle lubricant should be changed any time the rear axle has been submerged in water.

⁶Service refill capacity is determined by filling the transfer case to the bottom of the filler hole with the vehicle on a level surface.

⁷Approximate dry fill capacity including transmission fluid cooling system, actual refill capacities will vary based on vehicle application and transmission fluid cooling system (i.e. coolers size, cooling lines, auxiliary cooler capacities). The amount of transmission fluid and fluid level should be set by the indication on the dipstick's normal operating range.

⁸Automatic transmissions that require MERCON® LV should only use MERCON® LV fluid. Refer to *scheduled maintenance information* to determine the correct service interval. Use of any fluid other than the recommended fluid may cause transmission damage.

Maintenance and Specifications

ENGINE DATA

Engine	4.6L 2V V8 engine	4.6L 3V V8 engine	5.4L V8 engine
Cubic inches	281	281	330
Required fuel	87 octane	87 octane	87 octane or Ethanol (E85)*
Firing order	1-3-7-2-6-5-4-8	1-3-7-2-6-5-4-8	1-3-7-2-6-5-4-8
Ignition system	Coil on plug	Coil on plug	Coil on plug
Spark plug gap	0.052–0.056 inch (1.32–1.42mm)	0.039–0.043 inch (1.0–1.1mm)	0.039–0.043 inch (1.0–1.1mm)
Compression ratio	9.4:1	9.8:1	9.85:1

*5.4L 3V FFV engines only.

Maintenance and Specifications

Engine drivebelt routing

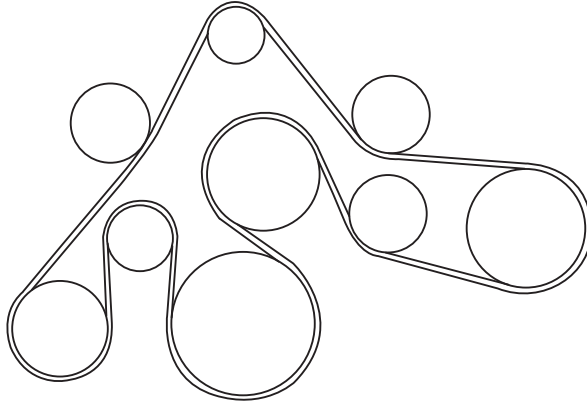

IDENTIFYING YOUR VEHICLE

Safety Compliance Certification Label

The National Highway Traffic Safety Administration Regulations require that a Safety Compliance Certification Label be affixed to a vehicle and prescribe where the Safety Compliance Certification Label may be located. The Safety Compliance Certification Label is located on the structure (B-Pillar) by the trailing edge of the driver's door or the edge of the driver's door.

MFD. BY FORD MOTOR CO.					
DATE: XX/XX	GVWR: XXXXXLB/ XXXXXKG				
FRONT GAWR: XXXXL	REAR GAWR: XXXXLB				
XXXXKG	WITH	XXXXKG	WITH		
XXXX/XXXXXXX	TIRES	XXXX/XXXXXXX	TIRES		
XXXX.XX	RIMS	XXXX.XX	RIMS		
AT XXX kPa/XX	PSI COLD	AT XXX kPa/XX	PSI COLD		
THIS VEHICLE CONFORMS TO ALL APPLICABLE FEDERAL MOTOR VEHICLE SAFETY AND THEFT PREVENTION STANDARDS IN EFFECT ON THE DATE OF MANUFACTURE SHOWN ABOVE.					
VIN: XXXXXXXXXXXXXXXXX			XXXXX		
TYPE: XXX			XXXXX		
EXT PNT: XX	RC: XX	DSO:			
WB ¹ BRK ¹ INT TR ¹ TP/PS ¹ TR ¹ AXLE ¹ TR SPR ¹ XXXXX					
XXX X XX X XX X XX XXX					
XXXXXXXXXXXX XXX XXX-XXXXXX-XX					

Maintenance and Specifications

Vehicle identification number (VIN)

The vehicle identification number is located on the driver side instrument panel.

Please note that in the graphic, XXXX is representative of your vehicle identification number.

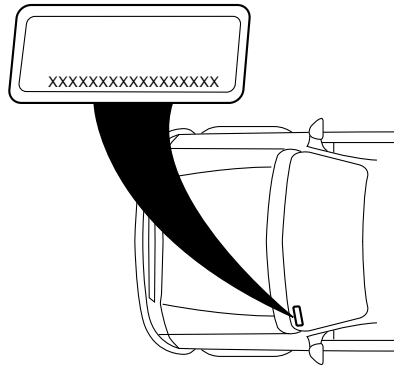

The Vehicle Identification Number (VIN) contains the following information:

1. World manufacturer identifier
2. Brake system / Gross Vehicle Weight Rating (GVWR) / Restraint System
3. Vehicle line, series, body type
4. Engine type
5. Check digit
6. Model year
7. Assembly plant
8. Production sequence number

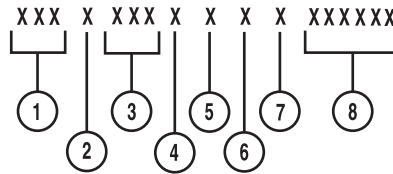

Maintenance and Specifications

TRANSMISSION CODE DESIGNATIONS

You can find a transmission code on the Safety Compliance Certification Label. The following table tells you which transmission each code represents.

MFD. BY FORD MOTOR CO.

DATE: XX/XX GVWR: XXXXXLB/ XXXXXKG
 FRONT GAWR: XXXXL REAR GAWR: XXXXLB
 XXXXKG WITH XXXXKG WITH
 XXXX/XXXXXXX TIRES: XXXX/XXXXXXX TIRES
 XXXX.XX RIMS: XXXX.XX RIMS
 AT XXX kPa/XX PSI COLD AT XXX kPa/XX PSI COLD

THIS VEHICLE CONFORMS TO ALL APPLICABLE FEDERAL MOTOR VEHICLE SAFETY AND THEFT PREVENTION STANDARDS IN EFFECT ON THE DATE OF MANUFACTURE SHOWN ABOVE.

VIN: XXXXXXXXXXXXXXXXXX XXXXX
 TYPE: XXX XXXXX



EXT PNT: XX RC: XX DSO: XXXXX
 WB¹ BRK² INT TR³ TP/PS⁴ R⁵ AXLE⁶ TR⁷ SPR⁸ XXXXX
 XXX X XX X XX X XX XXX

XXXXXXXXXXXX XX XXXX-XXXXXX-XX

↑

Description	Code
Four-speed automatic (4R75E)	Q
Six-speed automatic (6R80)	6

Accessories

GENUINE FORD ACCESSORIES FOR YOUR VEHICLE

A wide selection of Genuine Ford Accessories are available for your vehicle through your local Ford or Ford of Canada dealer. These quality accessories have been specifically engineered to fulfill your automotive needs; they are custom designed to complement the style and aerodynamic appearance of your vehicle. In addition, each accessory is made from high quality materials and meets or exceeds Ford's rigorous engineering and safety specifications. Ford Motor Company will repair or replace any properly dealer-installed Genuine Ford Accessories found to be defective in factory-supplied materials or workmanship during the warranty period, as well as any component damaged by the defective accessories. The accessories will be warranted for whichever provides you the greatest benefit:

- 12 months or 12,000 miles (20,000 km) (whichever occurs first), or
- the remainder of your new vehicle limited warranty.

Contact your dealer for details and a copy of the warranty.

The following is a list of several Genuine Ford Accessories. Not all accessories are available for all models. For a complete listing of the accessories that are available for your vehicle, please contact your dealer or visit our online store at: www.fordaccessories.com.

Exterior style

Bug shields
Chrome exhaust tips
Deflectors
Running boards
Splash guards
Step bars
Tonneau covers
Wheels

Interior style

Electrochromatic compass/temperature interior mirrors
Floor mats

Accessories

Lifestyle

Ash cup / smoker's package

Bedliners and bedmats

Cargo organization and management

Towing mirrors

Trailer hitches, wiring harnesses and accessories

Peace of mind

Mobile-Ease™ hands free communication system

Remote start

Vehicle security systems

Wheel locks

For maximum vehicle performance, keep the following information in mind when adding accessories or equipment to your vehicle:

- When adding accessories, equipment, passengers and luggage to your vehicle, do not exceed the total weight capacity of the vehicle or of the front or rear axle (GVWR or GAWR as indicated on the Safety Compliance Certification label). Consult your authorized dealer for specific weight information.
- The Federal Communications Commission (FCC) and Canadian Radio Telecommunications Commission (CRTC) regulate the use of mobile communications systems — such as two-way radios, telephones and theft alarms - that are equipped with radio transmitters. Any such equipment installed in your vehicle should comply with FCC or CRTC regulations and should be installed only by a qualified service technician.
- Mobile communications systems may harm the operation of your vehicle, particularly if they are not properly designed for automotive use.
- To avoid interference with other vehicle functions, such as anti-lock braking systems, amateur radio users who install radios and antennas onto their vehicle should not locate the Amateur Radio Antennas in the area of the driver's side hood.
- Electrical or electronic accessories or components that are added to the vehicle by the authorized dealer or the owner may adversely affect battery performance and durability.

Index

A

Accessory delay74
AdvanceTrac274
Air cleaner filter389, 392
Air conditioning41, 44, 46, 49
 manual heating and air
 conditioning system41
Airbag supplemental restraint
system180, 187, 190
 and child safety seats181
 description187, 190
 disposal193
 driver airbag181–182, 188, 191
 indicator light183, 189, 192
 operation181–182, 188, 191
 passenger
 airbag181–182, 188, 191
 side airbag187
Ambulance packages8
AM/FM24
Antifreeze
(see Engine coolant)365
Anti-lock brake system
(see Brakes)272
Anti-theft system139
 arming the system141
Armrests147
Audio system (see Radio) ...22, 24
Automatic transmission
 driving an automatic
 overdrive285, 288
 fluid, adding385, 388
 fluid, checking385, 388
 fluid, refill capacities393
 fluid, specification393
Auxiliary input jack (Line in)32

Axle

lubricant specifications393
refill capacities393

B

Battery363
 acid, treating emergencies363
 jumping a disabled battery331
 maintenance-free363
 replacement, specifications ...392
 servicing363
Bed extender116
Belt-Minder®175
 deactivating/activating the
 Belt-Minder®178
Booster seats212
Brakes272
 anti-lock272
 anti-lock brake system (ABS)
 warning light273
 fluid, checking and adding ...385
 fluid, refill capacities393
 fluid, specifications393
 lubricant specifications393
 parking273
 shift interlock281, 284
 trailer257
Bulbs59

C

Capacities for refilling fluids393
Cargo management system119
CD24
Cell phone use8
Changing a tire322
Child safety seats197
 attaching with tether straps ..207

Index

- in front seat198, 204
 - in rear seat198, 204
 - LATCH205
 - recommendations195
 - Child safety seats - booster seats212
 - Cleaning your vehicle
 - engine compartment348
 - instrument panel350
 - interior351
 - plastic parts349
 - safety belts351
 - washing346
 - waxing347
 - wheels347
 - wiper blades349
 - Climate control
(see Air conditioning or Heating)41, 44, 46, 49
 - Clock adjust
 - AM/FM25
 - AM/FM Stereo23
 - Compass, electronic68
 - calibration69
 - set zone adjustment69
 - Console68
 - Controls
 - power seat149
 - steering column83
 - Coolant
 - checking and adding365
 - refill capacities369, 393
 - specifications393
 - Cruise control
(see Speed control)80
 - Customer Assistance312
 - Ford Extended Service Plan343
 - Getting assistance outside the U.S. and Canada343
 - Getting roadside assistance ...312
 - Getting the service you need339
 - Ordering additional owner's literature344
 - Utilizing the Mediation/Arbitration Program342
- ### D
- Daytime running lamps
(see Lamps)56
 - Defrost
 - rear window and rearview mirrors44, 46, 49
 - windshield44, 46, 49
 - Dipstick
 - automatic transmission fluid385, 388
 - engine oil360
 - Driving under special conditions291, 303, 306
 - sand304
 - snow and ice307
 - through water305, 308
- ### E
- Electronic message center89, 100
 - Emergencies, roadside
 - jump-starting331
 - running out of fuel331, 377
 - Emission control system382
 - Engine397-398
 - cleaning348
 - coolant365

Index

- fail-safe cooling369
- idle speed control363
- lubrication specifications393
- refill capacities393
- service points357–358
- Engine block heater270
- Engine oil360
 - checking and adding360
 - dipstick360
 - filter, specifications362, 392
 - recommendations362
 - refill capacities393
 - specifications393
- Event data recording7
- Exhaust fumes270
- F**
- Fail safe cooling369
- Flexible Fuel Vehicle (FFV)371
- Floor mats112
- Fluid capacities393
- Fog lamps55
- Four-Wheel Drive vehicles296
 - driving off road301
 - electronic shift299
 - indicator light296
 - lever operated shift297
 - preparing to drive your vehicle281
- Fuel371
 - calculating fuel economy101, 378
 - cap374
 - capacity393
 - choosing the right fuel375
 - comparisons with EPA fuel economy estimates381
 - detergent in fuel375
 - filler funnel377
 - filling your vehicle with fuel371, 374, 378
 - filter, specifications371, 392
 - improving fuel economy378
 - octane rating376, 397–398
 - quality376–377
 - running out of fuel331, 377
 - safety information relating to automotive fuels371
- Fuel - flex fuel vehicle (FFV)371, 375–376
- Fuses314–315
- G**
- Gas cap (see Fuel cap)374
- Gas mileage (see Fuel economy)378
- Gauges18
 - transmission fluid temperature gauge22
- H**
- Hazard flashers313
- Headlamps54
 - aiming56–57
 - autolamp system54
 - bulb specifications60
 - daytime running lights56
 - flash to pass55
 - high beam55
 - replacing bulbs61
 - turning on and off54
- Heating
 - heating and air conditioning system41, 44, 46, 49
- Homelink wireless control system86

Index

- Hood356
- I**
- Ignition265, 397–398
- Illuminated visor mirror67
- Infant seats
(see Safety seats)197
- Inspection/maintenance (I/M)
testing384
- Instrument panel
 cleaning350
 cluster12
- J**
- Jack322
 positioning322
 storage322
- Jump-starting your vehicle331
- K**
- Keyless entry system
 autolock127
 keypad138
 locking and unlocking doors ..139
 programming entry code139
- Keys126, 141
 positions of the ignition265
- L**
- Lamps
 autolamp system54
 bulb replacement
 specifications chart60
 daytime running light56
 fog lamps55
 headlamps54
 headlamps, flash to pass55
 interior lamps58–59
 replacing bulbs61, 64
- LATCH anchors205
- Lights, warning and indicator12
 anti-lock brakes (ABS)273
- Limited-slip axle280
- Load limits244
- Loading instructions250
- Locks
 autolock127
 childproof130
 doors126
- Lubricant specifications393
- Lug nuts330
- Lumbar support, seats148–149
- M**
- Message center89, 100
 english/metric button106
 system check button103
 warning messages95, 107
- Mirrors74–75
 automatic dimming rearview
 mirror74
 fold away76
 heated44, 46, 49, 77
 programmable memory132
 side view mirrors (power)75
 signal77
- Moon roof85
- Motorcraft parts354, 392
- N**
- Navigation system40
- O**
- Octane rating376

Index

- Oil (see Engine oil)360
- P**
- Parking brake273
- Parts (see Motorcraft parts)392
- Passenger Occupant Classification Sensor163
- Power deployable running boards78
- Power distribution box (see Fuses)315, 318
- Power door locks126
- Power mirrors75
- Power point70
- Power steering279
- fluid, checking and adding384
- fluid, refill capacity393
- fluid, specifications393
- Power Windows72
- Preparing to drive your vehicle281
- R**
- Radio22, 24
- 6-CD in dash24
- Recommendations for attaching safety restraints for children195
- Relays314
- Remote entry system130
- illuminated entry136
- locking/unlocking doors131–132
- panic alarm132
- replacement/additional transmitters135
- replacing the batteries134
- Reverse camera294
- Reverse sensing system292
- Roadside assistance312
- S**
- Safety belts (see Safety restraints)161, 165–167, 170–172, 174
- Safety Canopy187–188, 190
- Safety defects, reporting345
- Safety restraints161, 165–167, 170–174
- Belt-Minder®175
- Belt-Minder®, deactivating/activating178
- extension assembly179
- for adults166–167, 170–172
- for children193
- lap belt169
- Occupant Classification Sensor163
- warning light and chime174–175
- Safety restraints - LATCH anchors205
- Safety seats for children197
- Safety Compliance Certification Label398
- Satellite Radio (if equipped)24
- Satellite Radio Information37
- Seats143
- child safety seats197
- cleaning352
- climate control46, 49, 155
- easy access/easyout feature ..152
- heated44, 153

Index

- memory seat132, 151
- SecuriCode keyless entry system138
- SecuriLock passive anti-theft system139, 141
- Servicing your vehicle355
- Setting the clock25
 - AM/FM stereo23
- Snowplowing7, 308–310
- Spark plugs, specifications392, 397–398
- Special notice
 - ambulance conversions8
 - four-wheel drive vehicles310–311
 - utility-type vehicles8
- Specification chart, lubricants393
- Speed control80
- Starting a flex fuel vehicle269
- Starting your vehicle265–266, 268–269
 - jump starting331
- Steering wheel
 - controls83
 - tilting66
- Stereo
 - 6-CD in dash24
 - CD-MP324
- SYNC®40
- T**
- Tailgate113
- Tilt steering wheel66
- Tire Pressure Monitoring System (TPMS)
 - Tires, Wheels and Loading233
- Tires218–219, 322
 - alignment226
 - care222
 - changing322, 326
 - checking the pressure222
 - inflating220
 - label232
 - replacing224
 - rotating226
 - safety practices225
 - sidewall information228
 - snow tires and chains243
 - spare tire323
 - terminology220
 - tire grades219
 - treadwear219, 223
- Towing250
 - recreational towing263
- Trailer Brake
 - Controller-Integrated257
 - trailer towing250
- Trailer Brake Controller-Integrated257
- Transfer case
 - fluid checking388
- Transmission281
 - brake-shift interlock (BSI)281, 284
 - fluid, checking and adding (automatic)385, 388
 - fluid, refill capacities393
 - lubricant specifications393
- Turn signal58
- U**
- USB port34

Index

V	
Vehicle Identification Number (VIN)	399
Vehicle loading	244
Ventilating your vehicle	270
W	
Warning lights (see Lights)	12
Washer fluid	359
Water, Driving through	308
Windows	
power	72
Windshield washer fluid and wipers	65
checking and adding fluid	359
replacing wiper blades	360