

Table of Contents

Introduction	4
Instrument Cluster	10
Warning and control lights	10
Gauges	14
Entertainment Systems	18
AM/FM stereo with CD	18
AM/FM stereo with in-dash six CD	21
AM/FM stereo cassette with CD	25
Climate Controls	46
Manual heating and air conditioning	46
Automatic temperature control	48
Auxiliary passenger climate control	51
Rear window defroster	53
Lights	54
Driver Controls	63
Windshield wiper/washer control	63
Steering wheel adjustment	64
Power windows	69
Mirrors	70
Speed control	72
Message center	83
Locks and Security	98
Keys	98
Locks	98
Anti-theft system	100

Table of Contents

Seating and Safety Restraints	111
Seating	111
Safety restraints	122
Airbags	135
Child restraints	143
Tires, Wheels and Loading	156
Tire Information	158
Tire Inflation	160
Changing tires	164
Lug Nut Torque	172
Tire Pressure Monitoring System (TPMS)	182
Vehicle loading	186
Trailer towing	193
Recreational towing	198
Driving	200
Starting	200
Brakes	203
Traction control/AdvanceTrac	206
Transmission operation	210
Roadside Emergencies	226
Getting roadside assistance	226
Hazard flasher switch	227
Fuel pump shut-off switch	227
Fuses and relays	228
Jump starting	239
Wrecker towing	245
Customer Assistance	246
Reporting safety defects (U.S. only)	254
Cleaning	255

Table of Contents

Maintenance and Specifications	261
Engine compartment	263
Engine oil	265
Battery	271
Engine Coolant	273
Fuel information	279
Air filter(s)	292
Part numbers	294
Refill capacities	295
Lubricant specifications	297
Accessories	304
Index	307

All rights reserved. Reproduction by any means, electronic or mechanical including photocopying, recording or by any information storage and retrieval system or translation in whole or part is not permitted without written authorization from Ford Motor Company. Ford may change the contents without notice and without incurring obligation.

Copyright © 2005 Ford Motor Company

Introduction

CALIFORNIA Proposition 65 Warning



WARNING: Engine exhaust, some of its constituents, and certain vehicle components contain or emit chemicals known to the State of California to cause cancer and birth defects or other reproductive harm. In addition, certain fluids contained in vehicles and certain products of component wear contain or emit chemicals known to the State of California to cause cancer and birth defects or other reproductive harm.

CONGRATULATIONS

Congratulations on acquiring your new Ford. Please take the time to get well acquainted with your vehicle by reading this handbook. The more you know and understand about your vehicle, the greater the safety and pleasure you will derive from driving it.

For more information on Ford Motor Company and its products visit the following website:

- In the United States: www.ford.com
- In Canada: www.ford.ca
- In Australia: www.ford.com.au
- In Mexico: www.ford.com.mx

Additional owner information is given in separate publications.

This *Owner's Guide* describes every option and model variant available and therefore some of the items covered may not apply to your particular vehicle. Furthermore, due to printing cycles it may describe options before they are generally available.

Remember to pass on this *Owner's Guide* when reselling the vehicle. It is an integral part of the vehicle.



Fuel pump shut-off switch: In the event of an accident the safety switch will automatically cut off the fuel supply to the engine. The switch can also be activated through sudden vibration (e.g. collision when parking). To reset the switch, refer to the *Fuel pump shut-off switch* in the *Roadside Emergencies* chapter.

SAFETY AND ENVIRONMENT PROTECTION

Warning symbols in this guide

How can you reduce the risk of personal injury to yourself or others? In this guide, answers to such questions are contained in comments highlighted by the warning triangle symbol. These comments should be read and observed.

Warning symbols on your vehicle

When you see this symbol, it is imperative that you consult the relevant section of this guide before touching or attempting adjustment of any kind.



Protecting the environment

We must all play our part in protecting the environment. Correct vehicle usage and the authorized disposal of waste, cleaning and lubrication materials are significant steps towards this aim. Information in this respect is highlighted in this guide with the tree symbol.



BREAKING-IN YOUR VEHICLE

Your vehicle does not need an extensive break-in. Try not to drive continuously at the same speed for the first 1,000 miles (1,600 km) of new vehicle operation. Vary your speed frequently in order to give the moving parts a chance to break in.

Drive your new vehicle at least 500 miles (800 km) before towing a trailer.

Do not add friction modifier compounds or special break-in oils during the first few thousand miles (kilometers) of operation, since these additives may prevent piston ring seating. See *Engine oil* in the *Maintenance and Specifications* chapter for more information on oil usage.

Introduction

SPECIAL NOTICES

Emission warranty

The New Vehicle Limited Warranty includes Bumper-to-Bumper Coverage, Safety Restraint Coverage, Corrosion Coverage, and 6.0L Power Stroke Diesel Engine Coverage. In addition, your vehicle is eligible for Emissions Defect and Emissions Performance Warranties. For a detailed description of what is covered and what is not covered, refer to the *Warranty Guide* that is provided to you along with your *Owner's Guide*.

Special instructions

For your added safety, your vehicle is fitted with sophisticated electronic controls.



Please read the section *Supplemental restraint system (SRS)* in the *Seating and Safety Restraints* chapter. Failure to follow the specific warnings and instructions could result in personal injury.



Front seat mounted rear-facing child or infant seats should **NEVER** be placed in front of an active passenger air bag.

Service Data Recording

Service data recorders in your vehicle are capable of collecting and storing diagnostic information about your vehicle. This potentially includes information about the performance or status of various systems and modules in the vehicle, such as engine, throttle, steering or brake systems. In order to properly diagnose and service your vehicle, Ford Motor Company, Ford of Canada, and service and repair facilities may access vehicle diagnostic information through a direct connection to your vehicle when diagnosing or servicing your vehicle.

Event Data Recording

Other modules in your vehicle — event data recorders — are capable of collecting and storing data during a crash or near crash event. The recorded information may assist in the investigation of such an event. The modules may record information about both the vehicle and the occupants, potentially including information such as:

- how various systems in your vehicle were operating;
- whether or not the driver and passenger seatbelts were buckled;
- how far (if at all) the driver was depressing the accelerator and/or the brake pedal;

6

2005 Explorer (exp)
Owners Guide (post-2002-fmt)
USA (fus)

Introduction

- how fast the vehicle was traveling; and
- where the driver was positioning the steering wheel.

To access this information, special equipment must be directly connected to the recording modules. Ford Motor Company and Ford of Canada do not access event data recorder information without obtaining consent, unless pursuant to court order or where required by law enforcement, other government authorities or other third parties acting with lawful authority. Other parties may seek to access the information independently of Ford Motor Company and Ford of Canada.

Notice to owners of pickup trucks and utility type vehicles



Utility vehicles have a significantly higher rollover rate than other types of vehicles.

Before you drive your vehicle, please read this *Owner's Guide* carefully. Your vehicle is not a passenger car. As with other vehicles of this type, failure to operate this vehicle correctly may result in loss of vehicle control, vehicle rollover, personal injury or death.

Be sure to read *Driving off road* in the *Driving* chapter.

Using your vehicle with a snowplow

Do not use this vehicle for snowplowing.

Your vehicle is not equipped with a snowplowing package.

Using your vehicle as an ambulance

Do not use this vehicle as an ambulance.

Your vehicle is not equipped with the Ford Ambulance Preparation Package.

MIDDLE EAST/NORTH AFRICA VEHICLE SPECIFIC INFORMATION

For your particular global region, your vehicle may be equipped with features and options that are different from the ones that are described in this *Owner's Guide*; therefore, a supplement has been supplied that complements this book. By referring to the pages in the provided supplement, you can properly identify those features, recommendations and specifications that are unique to your vehicle. **Refer to this Owner's Guide for all other required information and warnings.**

Introduction



These are some of the symbols you may see on your vehicle.

Vehicle Symbol Glossary

Safety Alert		See Owner's Guide	
Fasten Safety Belt		Air Bag-Front	
Air Bag-Side		Child Seat	
Child Seat Installation Warning		Child Seat Lower Anchor	
Child Seat Tether Anchor		Brake System	
Anti-Lock Brake System		Brake Fluid - Non-Petroleum Based	
Powertrain Malfunction		Speed Control	
Master Lighting Switch		Hazard Warning Flasher	
Fog Lamps-Front		Fuse Compartment	
Fuel Pump Reset		Windshield Wash/Wipe	
Windshield Defrost/Demist		Rear Window Defrost/Demist	

Introduction

Vehicle Symbol Glossary

Power Windows Front/Rear		Power Window Lockout	
Child Safety Door Lock/Unlock		Interior Luggage Compartment Release Symbol	
Panic Alarm		Engine Oil	
Engine Coolant		Engine Coolant Temperature	
Do Not Open When Hot		Battery	
Avoid Smoking, Flames, or Sparks		Battery Acid	
Explosive Gas		Fan Warning	
Power Steering Fluid		Maintain Correct Fluid Level	
Emission System		Engine Air Filter	
Passenger Compartment Air Filter		Jack	
Check fuel cap		Low tire warning	

Instrument Cluster

WARNING LIGHTS AND CHIMES

Standard instrument cluster

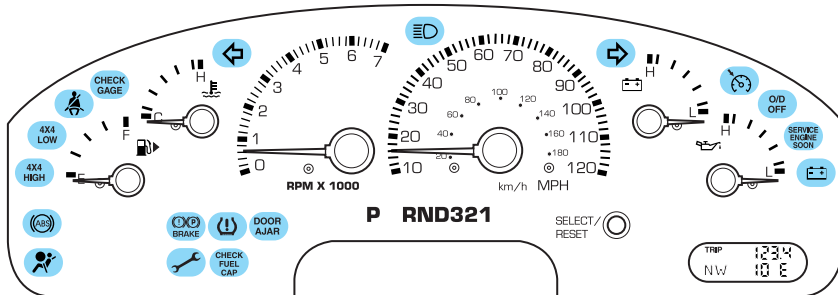

Optional instrument cluster

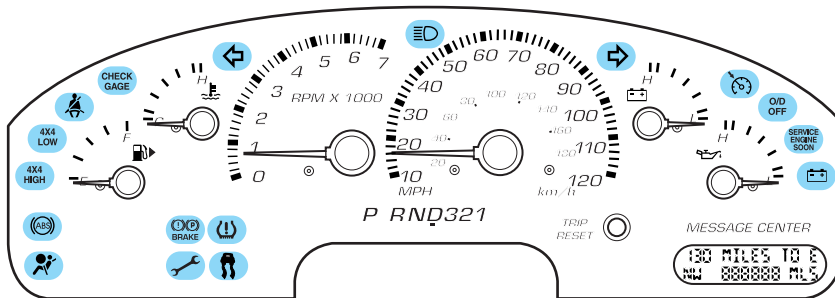

Warning lights and gauges can alert you to a vehicle condition that may become serious enough to cause expensive repairs. A warning light may illuminate when a problem exists with one of your vehicle's functions. Many lights will illuminate when you start your vehicle to make sure the bulb works. If any light remains on after starting the vehicle, have the respective system inspected immediately.

Service engine soon: The *Service engine soon* indicator light illuminates when the ignition is first turned to the ON position to check the bulb. Solid illumination after the engine is started indicates the On Board Diagnostics System (OBD-II) has detected a malfunction. Refer to

**SERVICE
ENGINE
SOON**

Instrument Cluster

On board diagnostics (OBD-II) in the *Maintenance and Specifications* chapter. If the light is blinking, engine misfire is occurring which could damage your catalytic converter. Drive in a moderate fashion (avoid heavy acceleration and deceleration) and have your vehicle serviced immediately.



Under engine misfire conditions, excessive exhaust temperatures could damage the catalytic converter, the fuel system, interior floor coverings or other vehicle components, possibly causing a fire.

Check fuel cap (if equipped):

Illuminates when the fuel cap may not be properly installed. Continued driving with this light on may cause the Service engine soon light to come on, refer to *Fuel filler cap* in the *Maintenance and Specifications* chapter.

**CHECK
FUEL
CAP**

Brake system warning light:

To confirm the brake system warning light is functional, it will momentarily illuminate when the ignition is turned to the ON position when the engine is not running, or in a position between ON and START, or by applying the parking brake when the ignition is turned to the ON position. If the brake system warning light does not illuminate at this time, seek service immediately from your dealership. Illumination after releasing the parking brake indicates low brake fluid level and the brake system should be inspected immediately by your servicing dealership.

BRAKE



Driving a vehicle with the brake system warning light on is dangerous. A significant decrease in braking performance may occur. It will take you longer to stop the vehicle. Have the vehicle checked by your dealer immediately.

Anti-lock brake system: If the ABS light stays illuminated or continues to flash, a malfunction has been detected, have the system serviced immediately. Normal braking is still functional unless the brake warning light also is illuminated.



Instrument Cluster

Air bag readiness: If this light fails to illuminate when ignition is turned to ON, continues to flash or remains on, have the system serviced immediately. A chime will also sound when a malfunction in the supplemental restraint system has been detected.



Safety belt: Reminds you to fasten your safety belt. A chime will also sound to remind you to fasten your safety belt.



Charging system: Illuminates when the battery is not charging properly.



Check gage: Illuminates when any of the following conditions has occurred:

- The engine coolant temperature is high.
- The engine oil pressure is low.
- The fuel gauge is at or near empty.

**CHECK
GAGE**

Low tire warning (if equipped with the Tire Pressure

Monitoring System): Illuminates when your tire pressure is low. If the light remains on at start up or while driving, the tire pressure should be checked. Refer to *Inspecting and Inflating Your Tires* in the *Tires, Wheels and Loading* chapter. When the ignition is first turned to ON, the light will illuminate for 3 seconds to ensure the bulb is working. If the light does not turn ON, have the system inspected by your servicing dealership. For more information on this system, refer to *Understanding Your Tire Pressure Monitoring System* in the *Tires, Wheels and Loading* chapter.

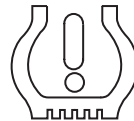

Electronic throttle control: Illuminates when the engine has defaulted to a 'limp-home' operation. Report the fault to a dealer at the earliest opportunity.



Instrument Cluster

Door ajar (if equipped):

Illuminates when the ignition is in the ON position and any door is open.

**DOOR
AJAR**

Overdrive off: Illuminates when the overdrive function of the transmission has been turned off, refer to the *Driving* chapter. If the light flashes steadily or does not illuminate, have the transmission serviced soon, or damage may occur.

**O/D
OFF**

AdvanceTrac® (if equipped): Illuminates when the AdvanceTrac® with RSC system is active. If the light remains on, have the system serviced immediately.



Four wheel drive low (if equipped): Illuminates when four-wheel drive low is engaged.

**4x4
LOW**

Four wheel drive high (if equipped): Illuminates when four-wheel drive high is engaged.

**4x4
HIGH**

Speed control: Illuminates when the speed control is activated. Turns off when the speed control system is deactivated.



Turn signal: Illuminates when the left or right turn signal or the hazard lights are turned on. If the indicators stay on or flash faster, check for a burned out bulb.



High beams: Illuminates when the high beam headlamps are turned on.



Key-in-ignition warning chime: Sounds when the key is left in the ignition in the OFF/LOCK or ACCESSORY position and the driver's door is opened.

Instrument Cluster

Headlamps on warning chime: Sounds when the headlamps or parking lamps are on, the ignition is off (the key is not in the ignition) and the driver's door is opened.

Turn signal warning chime: Sounds when the turn signal lever has been activated to signal a turn and not turned off after the vehicle is driven more than 1/2 mile (0.8 km).

GAUGES

Standard instrument cluster gauges

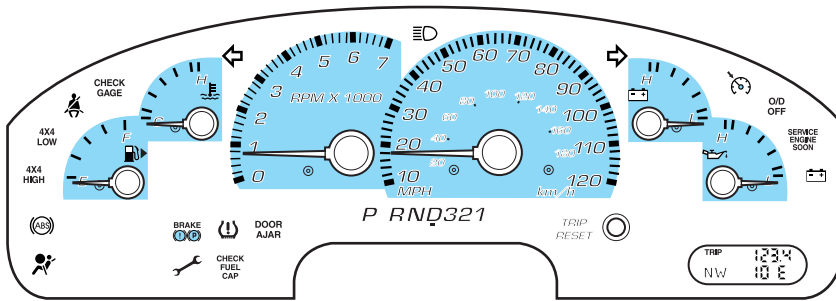

Optional instrument cluster gauges

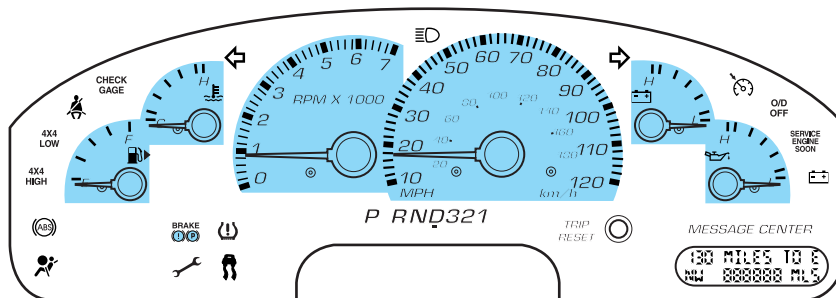

Instrument Cluster

Speedometer: Indicates the current vehicle speed.

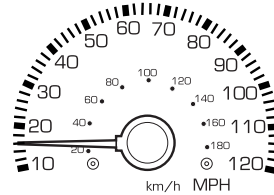

Engine coolant temperature gauge: Indicates engine coolant temperature. At normal operating temperature, the needle will be in the normal range (between “H” and “C”). If it enters the red section, the engine is overheating. Stop the vehicle as soon as safely possible, switch off the engine and let the engine cool.

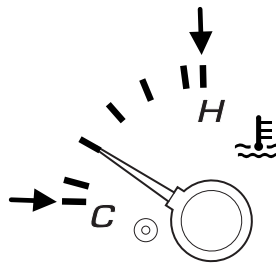

Never remove the coolant reservoir cap while the engine is running or hot.

Odometer: Registers the total miles (kilometers) of the vehicle.

- Standard instrument cluster



- Optional instrument cluster

Refer to Message Center in the Drivers Controls chapter on how to switch the display from Metric to English.

MESSAGE CENTER

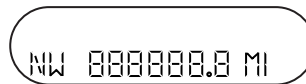

Trip odometer: Registers the miles (kilometers) of individual journeys.

- Standard instrument cluster

Press and release the SELECT/RESET button to toggle between odometer and trip odometer display.

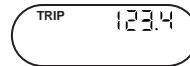
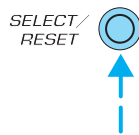

Instrument Cluster

- Optional instrument cluster

Press and release the TRIP/RESET button to toggle between odometer and trip odometer display.



Tachometer: Indicates the engine speed in revolutions per minute. Driving with your tachometer pointer continuously at the top of the scale may damage the engine.

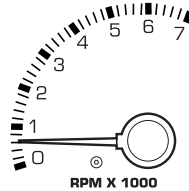

Battery voltage gauge: Indicates the battery voltage when the ignition is in the ON position. If the pointer moves and stays outside the normal operating range (as indicated by arrows), have the vehicle's electrical system checked as soon as possible.

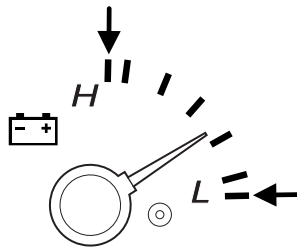

Engine oil pressure gauge: Indicates engine oil pressure. The needle should stay in the normal operating range (between "L" and "H"). If the needle falls below the normal range, stop the vehicle, turn off the engine and check the engine oil level. Add oil if needed. If the oil level is correct, have your vehicle checked at your dealership or by a qualified technician.

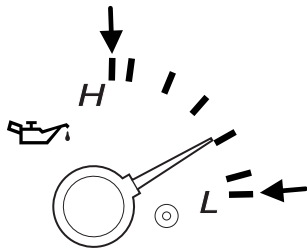

Instrument Cluster

Fuel gauge: Indicates approximately how much fuel is left in the fuel tank (when the ignition is in the ON position). The fuel gauge may vary slightly when the vehicle is in motion or on a grade.

The arrow next to the fuel pump icon indicates which side of the vehicle the fuel filler door is located.

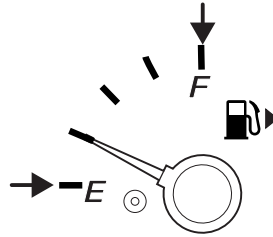

Refer to *Filling the tank* in the *Maintenance and Specifications* chapter for more information.

Entertainment Systems

AM/FM STEREO / SINGLE CD RADIO (IF EQUIPPED)

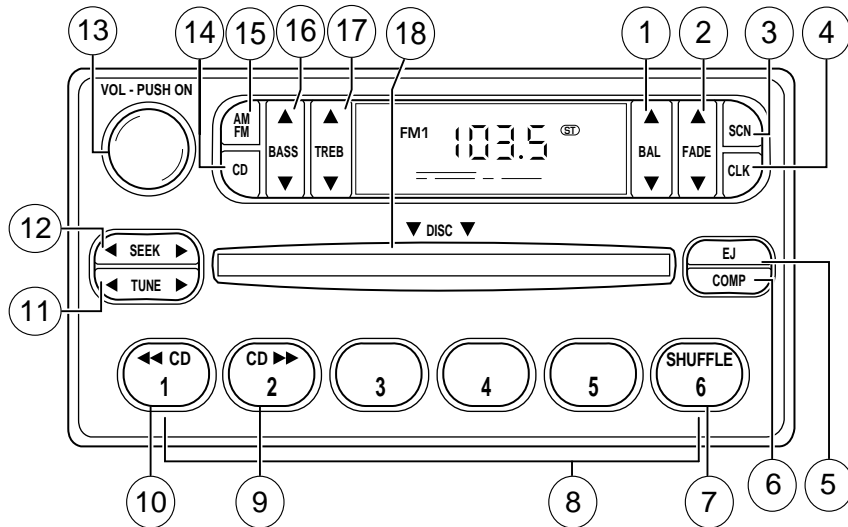

1. **BAL (Balance)**: Press ▲ / ▼ to shift sound to the left/right speakers.



2. **FADE**: Press ▲ / ▼ to shift sound to the front/rear speakers.



3. **SCN (Scan)**: Press to hear a brief sampling of all listenable stations or CD tracks. Press again to stop.



4. **CLK (Clock)**: To set the hour, press and hold CLK and press SEEK to decrease ◀ or increase ▶ the hours.



18

2005 Explorer (exp)
 Owners Guide (post-2002-fmt)
 USA (fus)

Entertainment Systems

To set the minute, press and hold CLK and press TUNE to decrease ◀ or increase ▶ the minutes.

5. **EJ (Eject):** Press to eject a CD.



6. **COMP (Compression):** In CD mode, press to bring louder and softer levels into more comfortable listening level. The compression icon (c) will appear in the display.



7. **SHUFFLE:** Press to listen to the tracks on the CD in random order. Press again to turn off.



8. **Memory presets:** To set a station: Select frequency band AM/FM; tune to a station. Press and hold a preset button until sound returns. This radio is equipped with six station memory preset controls which allow you to set up to six AM stations and 12 FM stations (six in FM1 and six in FM2).



9. **CD ▶▶ :** Press and hold until desired point of a selection is reached.



10. **◀◀ CD:** Press and hold until desired point of a selection is reached.



11. **TUNE:** In radio mode, press to move up or down the frequency band in individual increments.



12. **SEEK:** Press and release SEEK ◀ / ▶ for previous/next strong station, selection or track.



13. **Power/volume:** Press to turn ON/OFF; turn to increase or decrease volume levels.

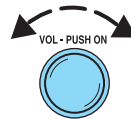

Entertainment Systems

14. **CD:** Press to enter CD mode or to play a CD already loaded into the system.



15. **AM/FM:** Press to choose a frequency band in radio mode.



16. **BASS:** Press ▲ / ▼ to increase/decrease the bass output.



17. **TREB (Treble):** Press ▲ / ▼ to increase/decrease the treble output.



18. **CD slot:** Insert a CD printed side up.

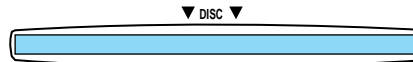

CD units are designed to play commercially pressed 4.75 in (12 cm) audio compact discs only. Due to technical incompatibility, certain recordable and re-recordable compact discs may not function correctly when used in Ford CD players. Irregular shaped CDs, CDs with a scratch protection film attached, and CDs with homemade paper (adhesive) labels should not be inserted into the CD player. The label may peel and cause the CD to become jammed. It is recommended that homemade CDs be identified with permanent felt tip marker rather than adhesive labels. Ballpoint pens may damage CDs. Please contact your dealer for further information.

Entertainment Systems

AUDIOPHILE SATELLITE COMPATIBLE AM/FM STEREO IN-DASH SIX CD RADIO (IF EQUIPPED)

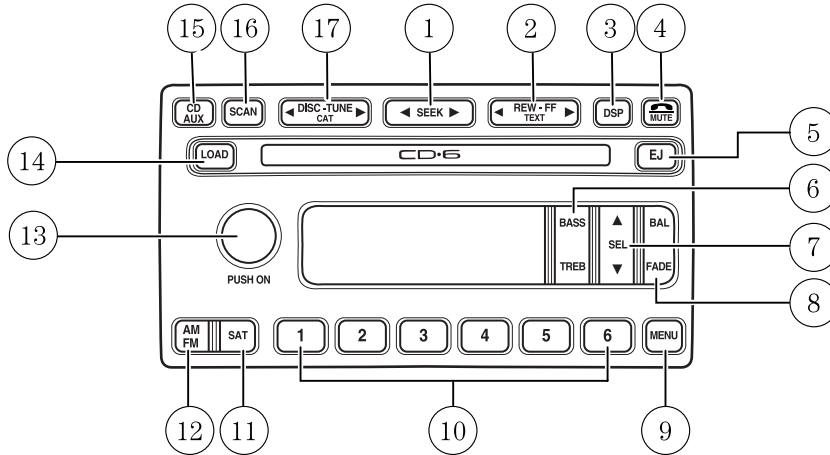

1. **Seek:** Press and release SEEK ◀ / ▶ for previous/next strong station or track.



2. **Rewind:** In CD mode, press until the desired point within the current selection is reached.



Fast forward: In CD mode, press until the desired point within the current selection is reached.

TEXT: TEXT is only available when equipped with Satellite radio. Your Audiophile radio comes equipped with Satellite ready capability. The kit to enable Satellite reception is available through your Ford dealer. Detailed Satellite instructions are included with the dealer installed kit. *Dealer installed satellite kit only available in the continental United States.*

3. DSP (Digital Signal

Processing): Press DSP to access the Ambiance menu. Ambiance gives the feeling of “being there” to your music, creating increased clarity as well as an open and spacious feel to the music. Press SEL to engage/disengage. Turn the volume control to increase/decrease the level of ambiance.

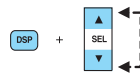

Entertainment Systems

Occupancy: Press DSP again to change the occupancy mode to optimize sound for ALL SEATS, DRIVERS SEAT or REAR SEATS. Press SEL to scroll through settings.

4. **Mute:** Press to MUTE playing media; press again to return to playing media



5. **Eject:** Press to eject a CD. Press EJ and a memory preset to eject a specific disk. Press and hold to eject all loaded discs.



6. **Bass:** Press BASS; then press SEL ▼ / ▲ to decrease/increase the bass output.

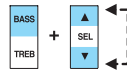

Treble: Press TREB; then press SEL ▼ / ▲ to decrease/increase the treble output.

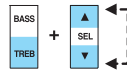

7. **Select:** Use with Bass, Treble, Balance, Fade and other menu selections.



8. **Balance:** Press BAL; then press SEL ▼ / ▲ to shift sound to the left/right speakers.

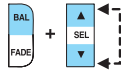

Fade: Press FADE; then press SEL ▼ / ▲ to shift sound to the rear/front speakers.

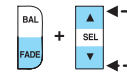

9. **Menu:** Press MENU to access clock mode, RDS on/off, Traffic announcement mode, Program type mode, Shuffle and Compression mode.

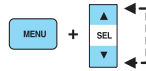

The Federal Communications Commission (FCC) and the Canadian Radio and Telecommunications Commission (CRTC) recommend that FM radio broadcasters use RDS technology to transmit information. FM radio stations are independently operated and individually elect to use RDS technology to transmit station ID and program type as desired.

Entertainment Systems

Traffic: Allows you to hear traffic broadcasts. With the feature ON, press SEEK or SCAN to find a station broadcasting a traffic report (if it is broadcasting RDS data). *Traffic information is not available in most U.S. markets.*

FIND Program type: Allows you to search RDS-equipped stations for a certain category of music format: Classic, Country, Info, Jazz, Oldies, R&B, Religious, Rock, Soft, Top 40. Press MENU until FIND appears in the display. Use SEL to scroll through music types. Press SEEK or SCAN to search for station playing requested music category.

Show TYPE: Displays the station's call letters or music format. Press MENU until SHOW appears in the display. Use SEL to select NONE, NAME or TYPE.

Shuffle: In CD mode, press to play tracks in a random order. Press MENU until SHUFFLE appears in the display. Use SEL to select SHUFFLE DISC, SHUFFLE TRK or SHUFFLE OFF.

Compression: In CD mode, brings soft and loud CD passages together for a more consistent listening level. Press MENU until COMPRESS is displayed. Press the SEL control to enable the compression feature when COMPRESS OFF is displayed. Press the SEL control again to disable the feature when COMPRESS ON is displayed.

Setting the clock: Press MENU until SELECT HOUR or SELECT MINS is displayed. Use SEL to manually increase (▲) or decrease (▼) the hours/minutes. Press MENU again to disengage clock mode.

10. **Memory presets:** To set a station: Select frequency band AM/FM; tune to a station, press and hold a preset button until sound returns.



11. **SAT (if equipped):** Your Audiophile radio comes equipped with Satellite Ready capability. The kit to enable the Satellite reception is available through your Ford dealer. Detailed satellite instructions are included with the dealer installed kit. *Dealer installed satellite kit only available in the continental United States.*



Entertainment Systems

12. **AM/FM:** Press to select AM/FM frequency band.



Autoset: Allows you to set the strongest local radio stations without losing your original manually set preset stations for AM/FM1/FM2. Press and momentarily hold AM/FM. AUTOSET will be shown. When the six strongest stations are filled, the station stored in preset 1 will begin playing. If there are less than six strong stations, the system will store the last one in the remaining presets. Press and hold again to disengage.

13. **Power/volume:** Press to turn ON/OFF; turn to increase or decrease volume levels.



Speed sensitive volume: Radio volume changes automatically and slightly with vehicle speed to compensate for road and wind noise. Recommended level is 1–3. Level 0 turns the feature off and level 7 is the maximum setting. Press and hold the volume control for five seconds. Then press SEL to increase (▲) or decrease (▼) the volume setting. The level will appear in the display.

14. **Load:** Press to load a CD. Press LOAD and a specific memory preset to load a specific disc. Press and hold to load up to six discs.



15. **CD AUX:** Press to access CD or AUX mode.



CD units are designed to play commercially pressed 4.75 in (12 cm) audio compact discs only. Due to technical incompatibility, certain recordable and re-recordable compact discs may not function correctly when used in Ford CD players. Irregular shaped CDs, CDs with a scratch protection film attached, and CDs with homemade paper (adhesive) labels should not be inserted into the CD player. The label may peel and cause the CD to become jammed. It is recommended that homemade CDs be identified with permanent felt tip marker rather than adhesive labels. Ballpoint pens may damage CDs. Please contact your dealer for further information.

Entertainment Systems

16. **Scan:** Press SCAN to hear a brief sampling of radio stations or CD tracks. Press again to stop.



17. **Disc/Tune:** Press ◀ or ▶ to manually tune down/up the radio frequency band, or change to the previous/next CD.



CAT: CAT is only available when equipped with Satellite Radio. Your Audiophile radio comes equipped with Satellite ready capability. The kit to enable Satellite reception is available through your Ford dealer. Detailed Satellite instructions are included with the dealer installed kit. *Dealer installed satellite kit only available in the continental United States.*

For information regarding SIRIUS Satellite Radio, please call toll-free 888-539-SIRIUS (888-539-7474) or visit the SIRIUS website at www.siriusradio.com

PREMIUM AM/FM STEREO/CASSETTE/SINGLE CD (IF EQUIPPED)

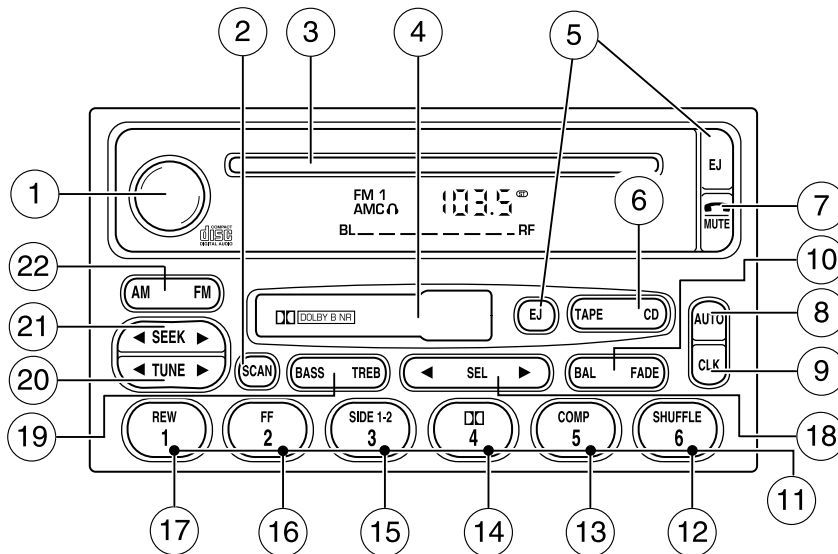

Entertainment Systems

1. **Power/volume:** Press to turn ON/OFF; turn to increase/decrease volume.

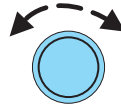

2. **SCAN:** Press to hear a brief sampling of all listenable stations, tape selections or CD tracks. Press again to stop.



3. **CD slot:** Insert a CD with the label side up.

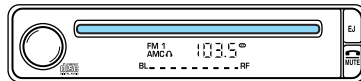

CD units are designed to play commercially pressed 4.75 in (12 cm) audio compact discs only. Due to technical incompatibility, certain recordable and re-recordable compact discs may not function correctly when used in Ford CD players. Irregular shaped CDs, CDs with a scratch protection film attached, and CDs with homemade paper (adhesive) labels should not be inserted into the CD player. The label may peel and cause the CD to become jammed. It is recommended that homemade CDs be identified with permanent felt tip marker rather than adhesive labels. Ballpoint pens may damage CDs. Please contact your dealer for further information.

4. **Cassette door:** Insert the cassette with the opening to the right.

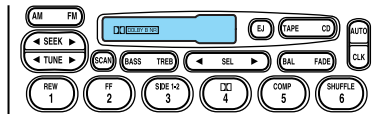

5. **EJ (Eject):** Press to eject the cassette/CD. The radio will resume playing.

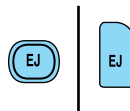

6. **TAPE:** Press to start tape play. Press to stop tape during rewind/fast forward.



Entertainment Systems

CD: Press to start CD play. With the dual media audio, press CD to toggle between single CD and CD changer play (if equipped).



7. **MUTE:** Press to MUTE playing media; press again to return to the playing media.



8. **AUTO:** Press to set first six strongest stations (if available) into AM, FM1 or FM2 memory buttons; press again to return to normal stations.



9. **CLK (Clock):** Press to toggle between station mode and clock mode. Press and hold to set the clock. Press the ◀ SEEK to decrease hours or SEEK ▶ to increase hours. Press the ◀ TUNE to decrease minutes or TUNE ▶ to increase minutes. If your vehicle has a stand alone clock this control will not function.



10. **BAL (Balance):** Press BAL; then press SEL ◀ / ▶ to shift sound to the left/right speakers.

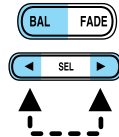

FADE: Press FADE; then press SEL ◀ / ▶ to shift sound to the rear/front speakers.

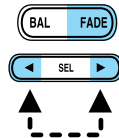

11. **Memory preset buttons:** To set a station: Select frequency band AM/FM, tune to a station, press and hold a preset button until sound returns.

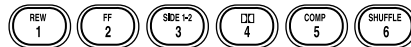

Entertainment Systems

12. **SHUFFLE:** Works in CD mode. Press to play tracks in random order. Press again to disable.



13. **COMP (Compression):** Works in CD mode. Press to bring soft and loud passages together for a more consistent listening level. A small "c" will appear in the display to indicate that compression is enabled. Press again to disable.



14. **DD Dolby® noise reduction:** Works in tape mode only. Reduces tape noise and hiss; press to activate/deactivate.



The Dolby® noise reduction system is manufactured under license from Dolby Laboratories Licensing Corporation. Dolby® and the double-D symbol are registered trademarks of Dolby Laboratories Licensing Corporation.

15. **SIDE 1-2:** Works in tape mode only. Press to play reverse side of the tape.



16. **FF (Fast Forward):** In CD mode, press for a slow advance, press and hold for a fast advance. In TAPE mode, press FF to enable Fast Forward feature. Press FF or TAPE to resume tape play.



17. **REW (Rewind):** In CD mode, press for a slow reverse, press and hold for a fast reverse. In TAPE mode, press REW to enable the rewind feature. Press REW or TAPE to resume tape play.



18. **SEL (Select):** Use with Bass, Treble, Balance and Fade controls.

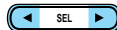

Entertainment Systems

19. **BASS:** Press BASS; then press SEL ◀/▶ to decrease/increase the bass output.

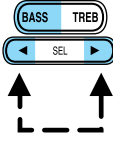

TREB (Treble): Press TREB; then press SEL ◀/▶ to decrease/increase the treble output.

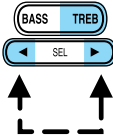

20. **TUNE:** Works in radio mode only. Press TUNE ◀/▶ to change frequency down/up.

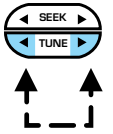

21. **SEEK:** Press and release SEEK ◀/▶ for previous/next strong station, selection or track.

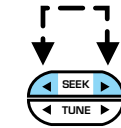

22. **AM/FM:** Press to select AM/FM1/FM2 frequency band.



Entertainment Systems

SATELLITE COMPATIBLE AM/FM STEREO IN-DASH SINGLE CD/MP3 RADIO — LATE AVAILABILITY (IF EQUIPPED)

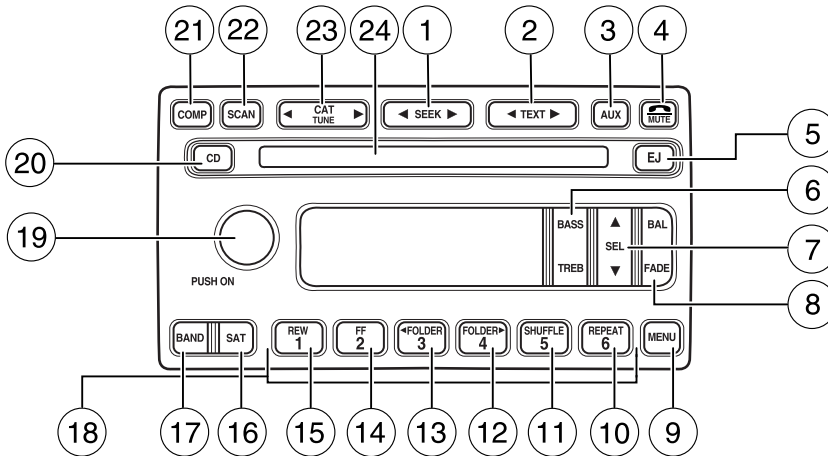

1. **SEEK:** Press and release SEEK ◀ / ▶ for previous/next strong station or track.



2. **TEXT:** The filename (Fi), song title (So), artist text (Ar) or album text (AL) may be viewed while playing an MP3 selection. When MP3 selection text is shown on the message display its corresponding text indicator (Fi, So, Ar, or AL) is shown in the elapsed time display. Press TEXT to scroll through the text fields. The display will scroll through all of the text in the current field before changing to the next field. (TEXT must be pressed within 3 seconds of the previous press to proceed to the next/last text display. The last text field shown on the display will become the new display message default.



TEXT is also available when equipped with Satellite radio. Your radio comes equipped with Satellite ready capability. The kit to enable Satellite reception is available through your dealer. Detailed Satellite instructions are included with the dealer installed kit. *Dealer installed satellite kit only available in the continental United States.*

Entertainment Systems

3. **AUX:** This function is not operational.



4. **MUTE:** Press to MUTE playing media; press again to return to playing media



5. **EJ:** Press to eject a CD.



6. **Bass:** Press BASS; then press SEL ▼ / ▲ to decrease/increase the bass output.

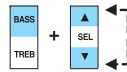

Treble: Press TREB; then press SEL ▼ / ▲ to decrease/increase the treble output.

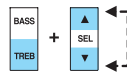

7. **Select:** Use with Bass, Treble, Balance, Fade and other menu selections.



8. **Balance:** Press BAL; then press SEL ▼ / ▲ to shift sound to the left/right speakers.

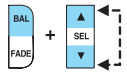

Fade: Press FADE; then press SEL ▼ / ▲ to shift sound to the rear/front speakers.

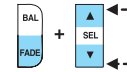

9. **Menu:** Press MENU and SEL to access AUTOSET, Speed sensitive volume and Setting the clock.

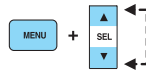

Autoset: Press MENU until AUTOSET appears in the display. Press SEL to toggle ON/OFF. Allows you to set the strongest local radio stations without losing your original manually set preset stations for AM/FM1/FM2. When the six strongest stations are filled, the station stored in preset 1 will begin playing. If there are less than six strong stations, the system will store the last one in the remaining presets.

Speed sensitive volume: Press MENU until SPEED VOL X appears in the display. Then press SEL to increase (▲) or decrease (▼) the

Entertainment Systems

volume setting. The level will appear in the display.

Radio volume changes automatically and slightly with vehicle speed to compensate for road and wind noise. Recommended level is 1–3. Level 0 turns the feature off and level 7 is the maximum setting.

Setting the clock: Press MENU until SELECT HOUR or SELECT MINS is displayed. Use SEL to manually increase (▲) or decrease (▼) the hours/minutes. Press MENU again to disengage clock mode.

Folder/Track mode: In MP3 mode, press MENU until MODE appears in the display. Use SEL to toggle between FOLDER (only tracks within selected folder are accessible) or TRACK (all tracks on disc are accessible) MODE.

10. **REPEAT:** Repeats current CD/MP3 track when active (ON). Press to shown repeat status. Press again to toggle status.



11. **SHUFFLE:** Plays CD/MP3 tracks in random order when active (ON). Press to show shuffle status. Press again to toggle status.



12. **FOLDER▶:** Press to access the next MP3 directory.



13. **FOLDER◀:** Press to access the previous MP3 directory.



14. **FF**(Fast forward): In CD/MP3 mode, press until desired selection is reached.



15. **REW**(Rewind): In CD/MP3 mode, press until desired selection is reached.



16. **SAT (if equipped):** Your radio comes equipped with Satellite Ready capability. The kit to enable the Satellite reception is available through your dealer. Detailed satellite instructions are included with the dealer installed kit. *Dealer installed satellite kit only available in the continental United States.*



Entertainment Systems

17. **BAND:** Press to toggle between AM/FM1/FM2 frequency band.



18. **Memory presets:** To set a station: Select frequency band; tune to a station, press and hold a preset button until sound returns.



19. **Power/volume:** Press to turn ON/OFF; turn to increase or decrease volume levels.

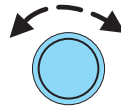

20. **CD:** Press to enter CD mode.



CD units are designed to play commercially pressed 4.75 in (12 cm) audio compact discs only. Due to technical incompatibility, certain recordable and re-recordable compact discs may not function correctly when used in Ford CD players. Irregular shaped CDs, CDs with a scratch protection film attached, and CDs with homemade paper (adhesive) labels should not be inserted into the CD player. The label may peel and cause the CD to become jammed. It is recommended that homemade CDs be identified with permanent felt tip marker rather than adhesive labels. Ballpoint pens may damage CDs. Please contact your dealer for further information.

21. **COMP**(Compression): Brings soft and loud CD passages together for a more consistent listening level when in CD mode. Press COMP to turn the feature ON/OFF.



22. **Scan:** Press SCAN to hear a brief sampling of radio stations or CD/MP3 tracks. Press again to stop.



23. **CAT/Tune:** Press ◀ or ▶ to



manually tune down/up the radio frequency band.

CAT: CAT is only available when equipped with Satellite Radio. Your radio comes equipped with Satellite ready capability. The kit to enable Satellite reception is available through your dealer. Detailed Satellite

Entertainment Systems

instructions are included with the dealer installed kit. *Dealer installed satellite kit only available in the continental United States.*

For information regarding SIRIUS Satellite Radio, please call toll-free 888-539-SIRIUS (888-539-7474) or visit the SIRIUS website at www.siriusradio.com

24. **CD slot:** Insert a CD with the label side up.

PREMIUM SATELLITE COMPATIBLE AM/FM STEREO/CASSETTE/SINGLE CD/MP3 — LATE AVAILABILITY (IF EQUIPPED)

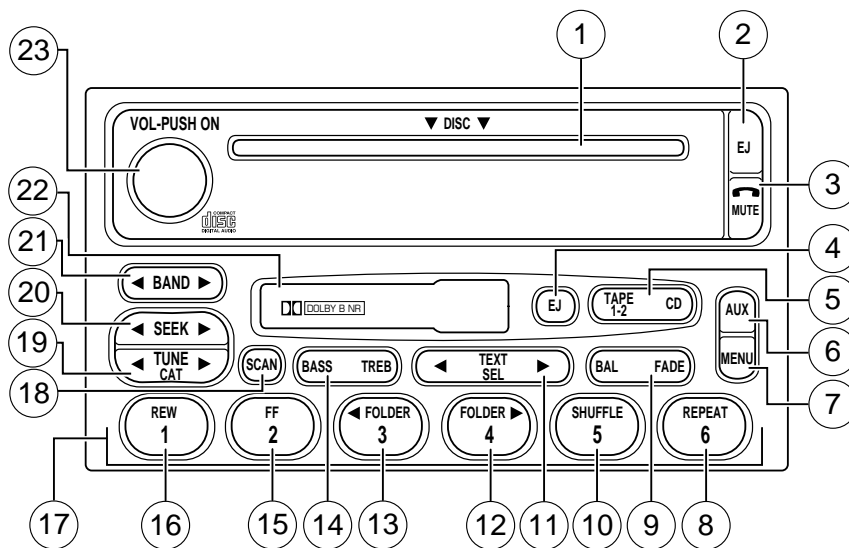

1. **CD slot:** Insert a CD with the label side up.

CD units are designed to play commercially pressed 4.75 in (12 cm) audio compact discs only. Due to technical incompatibility, certain recordable and re-recordable compact discs may not function correctly when used in Ford CD players. Irregular shaped CDs, CDs with a scratch protection film attached, and CDs with homemade paper (adhesive) labels should not be inserted into the CD player. The label may peel and cause the CD to

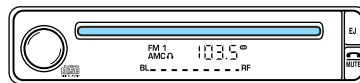

Entertainment Systems

become jammed. It is recommended that homemade CDs be identified with permanent felt tip marker rather than adhesive labels. Ballpoint pens may damage CDs. Please contact your dealer for further information.

2. **CD Eject:** Press to eject a CD.
The radio will resume playing.



3. **Mute:** Press to MUTE playing media; press again to return to the playing media.



4. **Tape Eject:** Press to eject the cassette. The radio will resume playing.



5. **Tape 1-2/CD:** Press to begin tape play. If a cassette is already playing, press to change playing sides.



CD: If a CD is loaded in the radio, pressing CD will cause the CD to begin playing.



6. **AUX:** This function is not operational.



7. **MENU:** Press to access the following functions:



Clock: Press MENU until HOURS or MINUTES is displayed. Press ◀ SEL ▶ to decrease/ increase hours or minutes.

Compression: In CD mode, compression brings soft and loud passages together for a more consistent listening level. Press MENU until COMPRESS is displayed. Use SEL to toggle on/off.

Speed sensitive volume: Radio volume changes automatically and slightly with vehicle speed to compensate for road and wind noise.

Entertainment Systems

Recommended level is 1–3. Level 0 turns the feature off and level 7 is the maximum setting. Press MENU until SPEED VOL X appears in the display. Then press SEL to increase/decrease the volume setting. The level will appear in the display.

Dolby: In tape mode, press MENU until DOLBY B XX appears in the display. Press SEL to toggle ON/OFF.

The Dolby® noise reduction system is manufactured under license from Dolby Laboratories Licensing Corporation. Dolby® and the double-D symbol are registered trademarks of Dolby Laboratories Licensing Corporation.

Folder/Track Mode: In MP3 mode, press MENU until MODE appears in the display. Use SEL to toggle between FOLDER (only tracks within selected folder are accessible) or TRACK (all tracks on disk are accessible) MODE.

Autoset: Press MENU until AUTOSSET appears in the display. Press SEL to toggle on/off. Allows you to set the strongest local stations without losing your original memory preset stations for AM/FM1/FM2. When the six strongest stations are filled, the station stored in preset 1 will begin playing. If there are less than six strong stations, the system will store the last one in the remaining presets.

8. **REPEAT:** Repeats current CD/MP3 track when active (ON). Press to show repeat status. Press again to toggle status.



9. **Balance:** Press BAL; then press SEL ◀ / ▶ to shift sound to the left/right speakers.

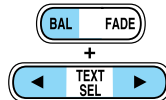

Fade: Press FADE; then press SEL ◀ / ▶ to shift sound to the rear/front speakers.

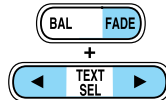

10. **SHUFFLE:** Plays CD/MP3 tracks in random order when active (ON). Press to show shuffle status. Press again to toggle status.



Entertainment Systems

11. **TEXT/SEL:** The filename, song title, artist or album text may be viewed while playing an MP3 selection. Press TEXT to scroll through the text fields. The display will scroll through all of the text in the current field before changing to the next field. (TEXT must be pressed within three seconds of the previous button press to proceed to the next/last text display.) The last text field shown on the display will become the new display message default.



TEXT is also available when equipped with Satellite radio. Your radio comes equipped with Satellite ready capability. The kit to enable Satellite reception is available through your dealer. Detailed Satellite instructions are included with the dealer installed kit. *Dealer installed satellite kit only available in the continental United States.*

Select: Use with Bass, Treble, Balance, Fade and other menu selections.

12. **FOLDER▶** : Press to access the next MP3 directory folder.



13. **FOLDER◀** : Press to access the previous MP3 directory folder.



14. **Bass:** Press BASS; then press SEL ◀ / ▶ to decrease/increase the bass output.

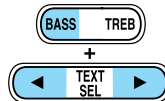

Treble: Press TREB; then press SEL ◀ / ▶ to decrease/increase the treble output.

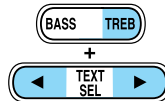

15. **Fast Forward (FF):** In CD mode, press and hold to fast forward. In tape mode, press to activate fast forward. Press FF again to return to play.



16. **Rewind (REW):** In CD mode, press and hold to reverse CD. In tape mode, press to rewind. Press REW again to return to play.



Entertainment Systems

17. **Memory preset buttons:** To set a station: Press BAND to select the frequency band (AM/FM1/FM2), tune to a station, press and hold a preset button until sound returns.

18. **Scan:** Press to hear a brief sampling of all listenable stations, tape selections or CD tracks. Press again to stop.



19. **Tune/CAT:** TUNE: Works in radio mode only. Press TUNE ◀ / ▶ to change frequency down/up.



CAT: CAT is only available when equipped with Satellite Radio. Your radio comes equipped with Satellite ready capability. The kit to enable Satellite reception is available through your dealer. Detailed Satellite instructions are included with the dealer installed kit. *Dealer installed satellite kit only available in the continental United States.*

For information regarding SIRIUS Satellite Radio, please call toll-free 888-539-SIRIUS (888-539-7474) or visit the SIRIUS website at www.siriusradio.com.

20. **Seek:** Press and release SEEK ◀ / ▶ for previous/next strong station, tape selection or CD track.



21. **BAND:** Press to toggle through AM/FM1/FM2 frequency bands.



22. **Cassette door:** Insert the cassette with the opening to the right.

23. **Power/volume:** Press to turn ON/OFF; turn to increase/decrease volume.

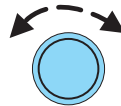

Entertainment Systems

AUDIOPHILE SATELLITE COMPATIBLE AM/FM STEREO IN-DASH SIX CD/MP3 RADIO — LATE AVAILABILITY (IF EQUIPPED)

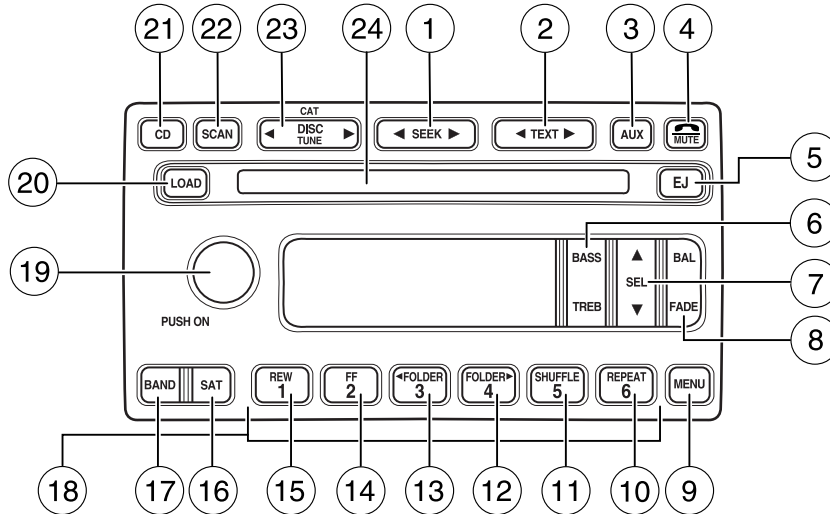

1. **SEEK:** Press and release SEEK ◀ / ▶ for previous/next strong station or track.



2. **TEXT:** The filename (Fi), song title (So), artist text (Ar) or album text (AL) may be viewed while playing an MP3 selection. When MP3 selection text is shown on the message display its corresponding text indicator (Fi, So, Ar, or AL) is shown in the elapsed time display. Press TEXT to scroll through the text fields. The display will scroll all of the text in the current field before changing to the next field. (TEXT must be pressed within 3 seconds of the previous button press to proceed to the next/last text display.)



TEXT is also available when equipped with Satellite radio. Your Audiophile radio comes equipped with Satellite ready capability. The kit to enable Satellite reception is available through your dealer. Detailed Satellite instructions are included with the dealer installed kit. *Dealer installed satellite kit only available in the continental United States.*

Entertainment Systems

3. **AUX:** This function is not operational.



4. **MUTE:** Press to MUTE playing media; press again to return to playing media



5. **EJ:** Press to eject a CD. Press EJ and a memory preset to eject a specific disc. Press and hold to eject all loaded discs.



6. **Bass:** Press BASS; then press SEL ▼ / ▲ to decrease/increase the bass output.

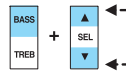

Treble: Press TREB; then press SEL ▼ / ▲ to decrease/increase the treble output.

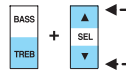

7. **Select:** Use with Bass, Treble, Balance, Fade and other menu functions.



8. **Balance:** Press BAL; then press SEL ▼ / ▲ to shift sound to the left/right speakers.

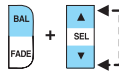

Fade: Press FADE; then press SEL ▼ / ▲ to shift sound to the rear/front speakers.

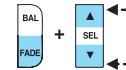

9. **Menu:** Press and hold MENU to access RDS on/off. Use SEL to toggle RDS on/off. Press MENU again to access Traffic mode, Program Type mode or Show Type mode. (MENU must be pressed within 10 seconds to proceed to the next RDS mode).

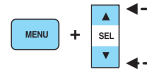

The Federal Communications Commission (FCC) and the Canadian Radio and Telecommunications Commission (CRTC) recommend that FM radio broadcasters use RDS technology to transmit information. FM radio stations are independently operated and individually elect to use RDS technology to transmit station ID and program type as desired.

Entertainment Systems

Traffic: Allows you to hear traffic broadcasts. With the feature ON, press SEEK or SCAN to find a station broadcasting a traffic report (if it is broadcasting RDS data). *Traffic information is not available in most U.S. markets.*

FIND Program type: Allows you to search RDS-equipped stations for a certain category of music format: Classic, Country, Info, Jazz, Oldies, R&B, Religious, Rock, Soft, Top 40. Press and hold MENU until RDS XX is shown in the display. Press MENU until FIND appears in the display. Use SEL to scroll through music types. Press SEEK or SCAN to search for a station playing the requested music category.

Show TYPE: Displays the station's call letters or music format. Press and hold MENU until RDS XX is shown in the display. Press MENU until SHOW appears in the display. Use SEL to select NAME or TYPE.

Compression: Brings soft and loud CD passages together for a more consistent listening level when in CD mode. Press MENU until compression status is displayed. Press the SEL control to enable the compression feature when COMPRESS OFF is displayed. Press the SEL control again to disable the feature when COMPRESS ON is displayed.

Occupancy mode: Press MENU until occupancy mode appears in the display. Press SEL to select ALL SEATS, DRIVER SEAT or REAR SEATS occupancy mode.

Autoset: Allows you to set the strongest local radio stations without losing your original manually set preset stations for AM/FM1/FM2. Press MENU until AUTOSET appears in the display. Press SEL to toggle ON/OFF. When the six strongest stations are filled, the station stored in preset 1 will begin playing. If there are less than six strong stations, the system will store the last one in the remaining presets.

Speed sensitive volume: Radio volume changes automatically and slightly with vehicle speed to compensate for road and wind noise. Recommended level is 1–3. Level 0 turns the feature off and level 7 is the maximum setting. Press MENU until SPEED VOL X appears in the display. Then press SEL to increase (▲) or decrease (▼) the volume setting. The level will appear in the display.

Setting the clock: Press MENU until SELECT HOUR or SELECT MINS is displayed. Use SEL to manually increase (▲) or decrease (▼) the hours/minutes. Press MENU again to disengage clock mode.

Entertainment Systems

Folder/Track Mode: In MP3 mode, press MENU until MODE appears in the display. Use SEL to toggle between FOLDER (only tracks within selected folder are accessible) or TRACK (all tracks on disc are accessible) MODE.

10. **REPEAT:** Repeats current CD/MP3 track when active (ON). Press to show repeat status. Press again to toggle status.



11. **SHUFFLE:** Plays CD/MP3 tracks in random order when active (ON). Press to show shuffle status. Press again to toggle status.



12. **FOLDER** ► : Press to access the next MP3 directory.



13. **FOLDER** ◀ : Press to access the previous MP3 directory.



14. **FF**(Fast forward): In CD mode, press until desired selection is reached.



15. **REW**(Rewind): In CD mode, press until desired selection is reached.



16. **SAT (if equipped):** Your radio comes equipped with Satellite Ready capability. The kit to enable the Satellite reception is available through your dealer. Detailed satellite instructions are included with the dealer installed kit. *Dealer installed satellite kit only available in the continental United States.*



17. **BAND:** Press to toggle between AM/FM1/FM2 frequency band.



18. **Memory presets:** To set a station: Select frequency band, tune to a station, press and hold a preset button until sound returns.



Entertainment Systems

19. **Power/volume:** Press to turn ON/OFF; turn to increase or decrease volume levels.

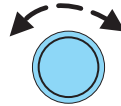

20. **Load:** Press to load a CD. Press LOAD and a memory preset to load to a specific disc slot. Press and hold to load up to six discs.



21. **CD:** Press to enter CD mode.



CD units are designed to play commercially pressed 4.75 in (12 cm) audio compact discs only. Due to technical incompatibility, certain recordable and re-recordable compact discs may not function correctly when used in Ford CD players. Irregular shaped CDs, CDs with a scratch protection film attached, and CDs with homemade paper (adhesive) labels should not be inserted into the CD player. The label may peel and cause the CD to become jammed. It is recommended that homemade CDs be identified with permanent felt tip marker rather than adhesive labels. Ballpoint pens may damage CDs. Please contact your dealer for further information.

22. **Scan:** Press SCAN to hear a brief sampling of radio stations or CD/MP3 tracks. Press again to stop.



23. **Disc/Tune:** Press ◀ or ▶ to manually tune down/up the radio frequency band, or to listen to the previous/next CD.



CAT: CAT is only available when equipped with Satellite Radio. Your Audiophile radio comes equipped with Satellite ready capability. The kit to enable Satellite reception is available through your dealer. Detailed Satellite instructions are included with the dealer installed kit. *Dealer installed satellite kit only available in the continental United States.*

For information regarding SIRIUS Satellite Radio, please call toll-free 888-539-SIRIUS (888-539-7474) or visit the SIRIUS website at www.siriusradio.com

24. **CD slot:** Insert a CD, label side up.

Entertainment Systems

FAMILY ENTERTAINMENT SYSTEM (IF EQUIPPED)

Your vehicle may be equipped with a Family Entertainment System (FES). Refer to the *DVD Supplement Guide* for further information on your system.

RADIO FREQUENCIES

AM and FM frequencies are established by the Federal Communications Commission (FCC) and the Canadian Radio and Telecommunications Commission (CRTC). Those frequencies are:

AM - 530, 540–1700, 1710 kHz

FM- 87.7, 87.9–107.7, 107.9 MHz

RADIO RECEPTION FACTORS

There are three factors that can affect radio reception:

- Distance/strength: The further you travel from an FM station, the weaker the signal and the weaker the reception.
- Terrain: Hills, mountains, tall buildings, power lines, electric fences, traffic lights and thunderstorms can interfere with your reception.
- Station overload: When you pass a broadcast tower, a stronger signal may overtake a weaker one and play while the weak station frequency is displayed.

CASSETTE/PLAYER CARE

Do:

- Use only cassettes that are 90 minutes long or less.
- Tighten very loose tapes by inserting a finger or pencil into the hole and turning the hub.
- Remove loose labels before inserting tapes.
- Allow tapes which have been subjected to extreme heat, humidity or cold to reach a moderate temperature before playing.
- Clean the cassette player head with a cassette cleaning cartridge after 10–12 hours of play to maintain good sound/operation.

Don't:

- Expose tapes to direct sunlight, extreme humidity, heat or cold.
- Leave tapes in the cassette player for a long time when not being played.

44

2005 Explorer (exp)
Owners Guide (post-2002-fmt)
USA (fus)

Entertainment Systems

CD/CD PLAYER CARE

Do:

- Handle discs by their edges only. Never touch the playing surface.
- Inspect discs before playing. Clean only with an approved CD cleaner and wipe from the center out.

Don't:

- Expose discs to direct sunlight or heat sources for extended periods of time.
- Insert more than one disc into each slot of the CD changer magazine.
- Clean using a circular motion.

CD units are designed to play commercially pressed 4.75 in (12 cm) audio compact discs only. Due to technical incompatibility, certain recordable and re-recordable compact discs may not function correctly when used in Ford CD players. Irregular shaped CDs, CDs with a scratch protection film attached, and CDs with homemade paper (adhesive) labels should not be inserted into the CD player. The label may peel and cause the CD to become jammed. It is recommended that homemade CDs be identified with permanent felt tip marker rather than adhesive labels. Ballpoint pens may damage CDs. Please contact your dealer for further information.

AUDIO SYSTEM WARRANTY AND SERVICE

Refer to the *Warranty Guide* for audio system warranty information. If service is necessary, see your dealer or qualified technician.

Climate Controls

MANUAL HEATING AND AIR CONDITIONING SYSTEM (IF EQUIPPED)

1. Temperature selection:

Controls the temperature of the airflow in the vehicle.

2. **Air flow selections:** Controls the direction of the airflow in the vehicle. See the following for a brief description on each control.

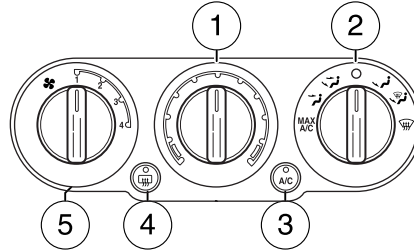

MAX A/C:

Uses recirculated air through the instrument panel registers to cool the vehicle. This mode is noisier than other modes, but is more economical and efficient and may help prevent undesirable odors from entering the vehicle.

 : Distributes outside air through the instrument panel vents.

 : Distributes outside air through the instrument panel vents and the floor vents.

O (OFF): Outside air is shut out and the fan will not operate.

 : Distributes outside air through the floor vents.

 : Distributes outside air through the windshield defroster vents and floor vents.

 : Distributes outside air through the windshield defroster vents.

3. **A/C:** Uses outside air to cool the vehicle. Air flows from the instrument panel register vents only.

4. **Rear defroster:** Clears ice and fog from the rear window.

5. **Fan speed adjustment:** Controls the volume of air circulated in the vehicle.

Operating tips

- To reduce fog build up on the windshield during humid weather, place the air flow selector in the  position.
- To reduce humidity build up inside the vehicle, do not drive with the air flow selector in the O (OFF) position.
- Do not put objects under the front seats that will interfere with the airflow to the rear seats.
- Remove any snow, ice or leaves from the air intake area at the base of the windshield.

Climate Controls

- To improve the A/C cool down, drive with the windows slightly open for 2–3 minutes after start up or until the vehicle has been “aired out.”

For maximum cooling performance in panel () mode:

- Select MAX A/C mode. MAX A/C uses recirculated air with A/C to provide a cooler airflow.
- Move the temperature control to the coolest setting.
- Set the fan to the highest speed initially, then adjust in order to maintain comfort.

To allow side window defogging and demisting while warming up the vehicle cabin:

1. Select .
2. Select A/C.
3. Set the temperature control to maintain comfort.
4. Set the fan speed to highest setting.
5. Direct the outer instrument panel vents towards the side windows. To increase airflow to the outer instrument panel vents, close the vents located in the middle of the instrument panel.





Do not place objects on top of the instrument panel as these objects may become projectiles in a collision or sudden stop.

Climate Controls

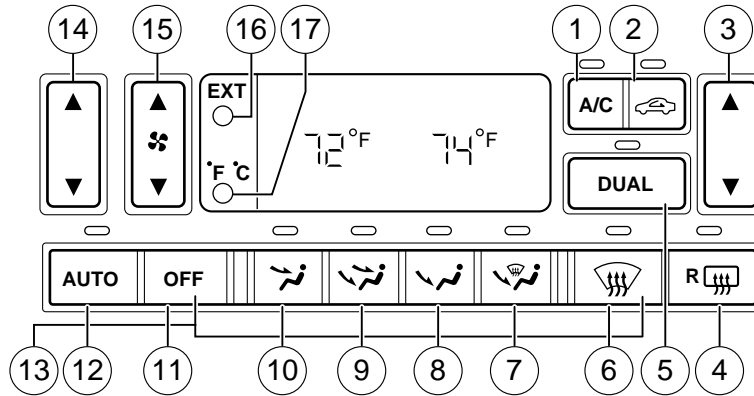
Dual Automatic Temperature Control (DATC) system (if equipped)



1. **A/C control:** Uses outside air to cool the vehicle. Press to turn on/off in all modes except  or .



2. **Recirculation control:** Cools the vehicle more quickly by recirculating the cabin air instead of using outside air and helps prevent unpleasant outside odors or fumes from entering the vehicle. Press to turn on/off.



3. **Passenger side temperature control:** Controls the temperature on the passenger side of the vehicle when in dual zone mode. To enter dual zone, press the passenger temperature control or DUAL. The passenger temperature will appear in the display.









4. **Rear defroster control:** Removes ice and fog from the rear window. Press to turn on/off.





5. **DUAL** (Single/dual electric temperature control): Allows the driver to have full control of the cabin temperature settings (single zone) or allows the passenger to have control of their individual temperature settings (dual zone control). Press to enable turn on dual zone mode, press again to return to single zone.



Climate Controls

- 6.  : Distributes outside air through the windshield defroster vents.
- 7.  : Distributes outside air through the windshield defroster vents and floor vents.
- 8.  : Distributes outside air through the floor vents.
- 9.  : Distributes outside air through the instrument panel vents and the floor vents.
- 10.  : Distributes outside air through the instrument panel vents.
- 11. **OFF**: Outside air is shut out and the fan will not operate. 

- 12. **AUTO**: Press to select the desired temperature shown in the display window. The system will automatically determine the fan speed, airflow location, outside or recirculated air to heat or cool the vehicle to the selected temperature. 

- 13. **Manual override controls**:  Allows you to manually determine where airflow is directed. To return to fully automatic control, press AUTO.

- 14. **Driver's side temperature control**: Controls the temperature on the driver side of the vehicle. 

- 15. **Fan Speed**: Used to manually enable or disable the fan speed. 

- 16. **EXT**: Displays the outside air temperature. It will remain displayed until the EXT control is pressed again. The external temperature will be most accurate when the vehicle has been moving for a period of time. 

- 17. **Temperature conversion**: Press to toggle between Fahrenheit and Celsius temperature on the DATC display only. The set point temperatures in Celsius will be displayed in half-degree increments. 

Climate Controls

Operating tips

- To reduce fog build up on the windshield during humid weather, place the air flow selector in the  position.
- To reduce humidity build up inside the vehicle, do not drive with the air flow selector in OFF or with recirculated air engaged.
- Do not put objects under the front seats that will interfere with the airflow to the rear seats.
- Remove any snow, ice or leaves from the air intake area at the base of the windshield.
- To improve the A/C cool down, drive with the windows slightly open for 2–3 minutes after start up or until the vehicle has been “aired out.”

For maximum cooling performance:

- Select and A/C and recirculated air. Use recirculated air with A/C to provide a cooler airflow.
- Move the temperature control to the coolest setting.

To allow side window defogging and demisting while warming up the vehicle cabin:

1. Select .
2. Select A/C.
3. Set the temperature control to maintain comfort.
4. Set the fan speed to highest setting.
5. Direct the outer instrument panel vents towards the side windows. To increase airflow to the outer instrument panel vents, close the vents located in the middle of the instrument panel.



Do not place objects on top of the instrument panel as these objects may become projectiles in a collision or sudden stop.





Climate Controls

Auxiliary system (if equipped)

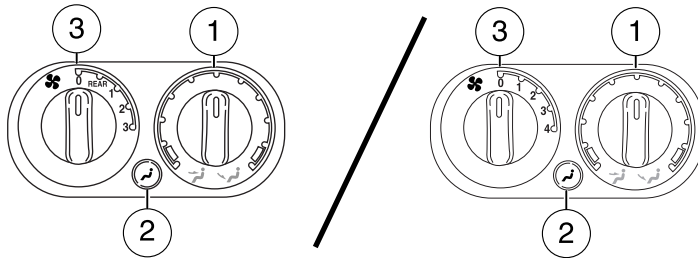
Your vehicle may be equipped with auxiliary climate controls. These allow the front or rear seat passengers to control airflow direction, temperature and fan level of the rear compartment to quickly heat or cool the entire vehicle.

Front auxiliary controls:



- 1. Temperature control:** Determines temperature level. If the main climate control system is cooling in MAX A/C or  mode, the auxiliary controls will not function as the entire vehicle will operate at a full cool temperature.
- 2. Mode selector:** Press to select air flow direction to  (Floor) or  (Panel).
 -  Directs air to the floor of the third row seating.
 -  directs air to the overhead registers of the second and third row seating. The selected mode will illuminate on the temperature control.
- 3. Fan control:** Determines fan speed levels. Turn to REAR (if equipped) to give rear seat passengers control of the rear auxiliary controls. Otherwise, the front controls will determine the settings for the entire vehicle cabin. If set to O (OFF), the front and rear auxiliary controls will not function.

Climate Controls



Rear auxiliary controls (if equipped):

Once the front auxiliary control is set to REAR, the rear seat passengers may use the rear auxiliary controls in the overhead console to make the desired adjustments.

1. Temperature control:

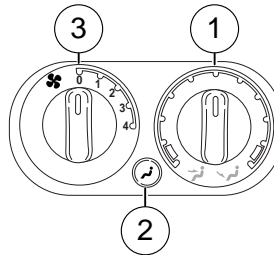
Determines temperature levels. If the main climate control system is cooling in MAX A/C or  mode, the auxiliary controls will not function as the entire vehicle will operate at a full cool temperature.



2. **Mode selector:** Press to select between air flow to  (Floor) or  (Panel).



 Directs air to the floor of the third row seating.

 directs air to the overhead registers of the second and third row seating. The selected mode will illuminate on the temperature control.

3. **Fan control:** Determines fan speed levels.

Floor console climate controls (if equipped)

Controls the direction of the airflow to the rear of the vehicle.

 selects air flow from the console panel registers.  selects air flow from the floor console registers.

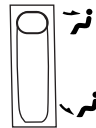

Climate Controls

REAR WINDOW DEFROSTER

The rear defroster control is located on the instrument panel.

Press the rear defroster control to clear the rear window of thin ice and fog.

- A small LED will illuminate when the rear defroster is activated.

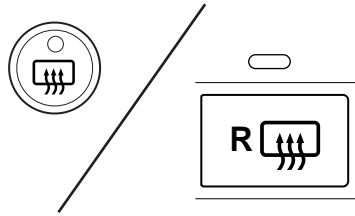



The ignition must be in the 3 (ON) position to operate the rear window defroster.

The defroster turns off automatically after 10 minutes or when the ignition is turned to the 1 (OFF/LOCK) position. To manually turn off the defroster before 10 minutes have passed, push the control again.

Lights

HEADLAMP CONTROL

-  Turns the lamps off.
-  Turns on the parking lamps, instrument panel lamps, license plate lamps and tail lamps.
-  Turns the headlamps on.

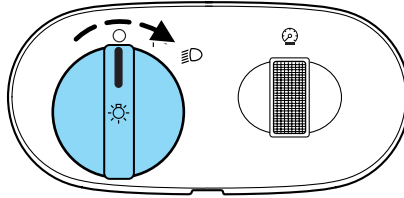

Autolamp system (if equipped)

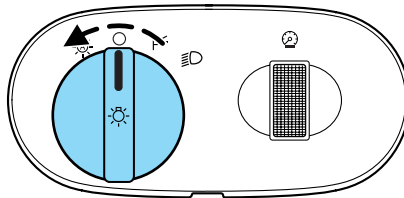

The autolamp system sets the headlamps to turn on and off automatically. The autolamp control, located on the headlamp control, may be set to:

- turn on the lamps automatically at night
- turn off the lamps automatically during the daylight
- keep the lamps on for up to three minutes after the key is turned to OFF.



To turn the autolamps on, rotate the control counterclockwise to  .

Foglamp control (if equipped)

The foglamps can be turned on only when the headlamp control is in the ,  and  position and the high beams are not turned on.

Pull headlamp control towards you to turn foglamps on. The foglamp indicator light  will illuminate when foglamp is activated.

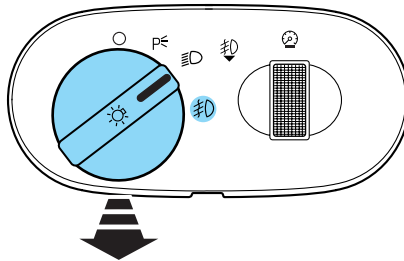

Push the headlamp control towards the instrument panel to deactivate the foglamps.



Lights

Daytime running lamps (DRL) (if equipped)

To activate DRL:

- the ignition must be in the ON position and
- the headlamp control is in the  or  position
- the parking brake must be disengaged.

 Always remember to turn on your headlamps at dusk or during inclement weather. The Daytime Running Light (DRL) System does not activate your tail lamps and generally may not provide adequate lighting during these conditions. Failure to activate your headlamps under these conditions may result in a collision.

High beams

Push the lever toward the instrument panel to activate. Pull the lever towards you to deactivate.

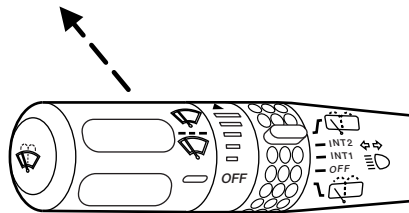

Flash to pass

Pull the lever toward you to activate. Release the lever to deactivate.

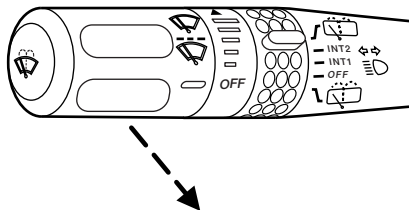

Lights

PANEL DIMMER CONTROL

Use to adjust the brightness of the instrument panel when exterior lights are on.

- Rotate up to brighten.
- Rotate down to dim.
- Rotate to full up position (past detent) to turn on interior lamps.
- Rotate to full down position (past detent) to turn off the interior lamps and will also disable the illuminated entry feature.

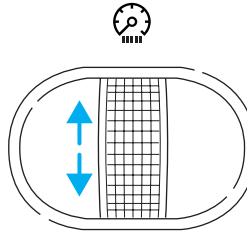

AIMING THE HEADLAMPS

The headlamps on your vehicle are properly aimed before leaving the assembly plant. If your vehicle is involved in an accident or if you have problems fixing the alignment of your headlamps, have them checked by a qualified service technician.

Headlamp aim adjustment

The headlamps on your vehicle can only be vertically adjusted. Your vehicle does not require horizontal aim adjustments.

To adjust the headlamps:

1. Park your vehicle on a level surface about 25 feet (7.6 meters) away from a vertical plain surface (3). Check your headlamp alignment at night or in a dark area so that you can see the headlamp beam pattern.

- (1) Eight feet
- (2) Center height of lamp to ground
- (3) Twenty-five feet
- (4) Horizontal reference line

2. The center of the headlamp has a 3.0 mm circle on the lens. Measure the height from the center of your headlamp to the ground (2) and mark an 8 foot (2.4 meter) long horizontal line on the plain surface (1) at this height (masking tape works well).

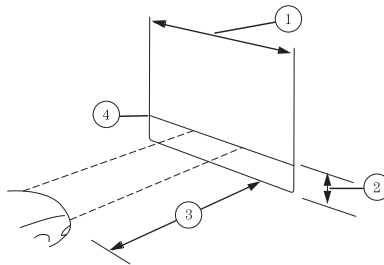

Lights

3. Turn on the low beam headlamps. The brightest part of the light should be below the horizontal line (4). If it is above the line the headlamp will need to be adjusted.

4. Open the hood.

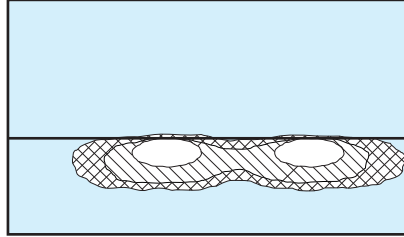

5. Locate the vertical adjuster for each headlamp. Adjust the aim by turning the adjuster control either clockwise (to adjust down) or counterclockwise (to adjust up).

Note: Use a 4 mm socket or box wrench to turn the vertical adjuster control.

6. Horizontal aiming is not required for this vehicle and is non-adjustable.

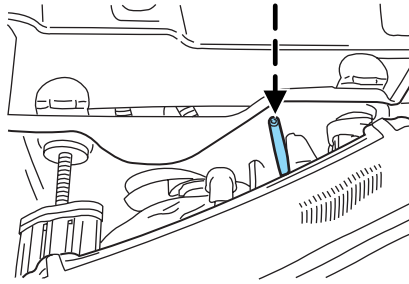

TURN SIGNAL CONTROL ⇄

- Push down to activate the left turn signal.
- Push up to activate the right turn signal.

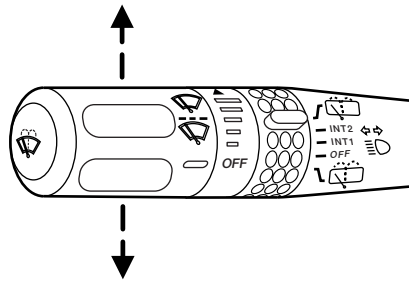

Lights

INTERIOR LAMPS

Dome/reading lamps

The dome lamp lights when:

- any door is opened.
- the instrument panel dimmer switch is rotated up until the courtesy lamps come on.
- any of the remote entry controls are pressed and the ignition is OFF.

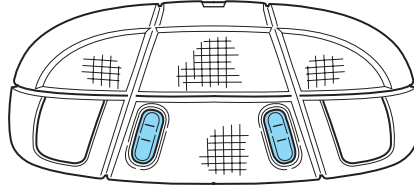

The reading portion, the two outer lights, can only be toggled on and off at the lamp.

Cargo/reading lamps

The dome portion of the lamp or the center light can be turned on when the headlamp control is rotated fully up or when a door is opened.

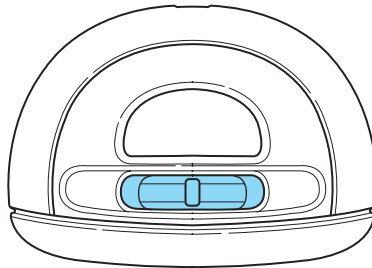

With the ignition in the ACC or ON position, the rear dome lamp can be turned ON or OFF by sliding the control.

BULBS

Headlamp Condensation

The headlamps are vented to equalize pressure. When moist air enters the headlamp(s) through the vents, there is a possibility that condensation can occur. This condensation is normal and will clear within 45 minutes of headlamp operation.

Replacing exterior bulbs

Check the operation of all the bulbs frequently.

Lights

Replacing the interior bulbs

Check the operation of the bulbs frequently. To replace any of the interior bulbs, see a dealer or qualified technician.

Using the right bulbs

Replacement bulbs are specified in the chart below. Headlamp bulbs must be marked with an authorized "D.O.T." for North America and an "E" for Europe to assure lamp performance, light brightness and pattern and safe visibility. Using incorrect bulbs may damage the lamp assembly or void the lamp assembly warranty or may not provide quality bulb burn time.

Function	Number of bulbs	Trade number
Park/turn lamps (front)	2	3457
Headlamp high beam	2	9005
Headlamp low beam	2	9006
Rear stop/turn/tail lamps	2	3157K
Rear license plate lamps	2	168
Backup lamp	2	3156K
High-mount stop lamps	5	W5W
Fog lamp	2	9145
Cargo lamp	1	211-2
Interior overhead lamp	1	912 (906)
Front door courtesy lamp	1	168
Map lamps	2	168 (T10)
Ashtray lamp	1	161
All replacement bulbs are clear in color except where noted.		
To replace all instrument panel lights - see your dealer.		

Lights

Replacing headlamp bulbs

Do not touch the glass of a halogen bulb.

1. Turn off the headlamps and open the hood.
2. Pry up the two retainer pins until they stop to release the headlamp assembly from the vehicle, then pull headlamp forward.

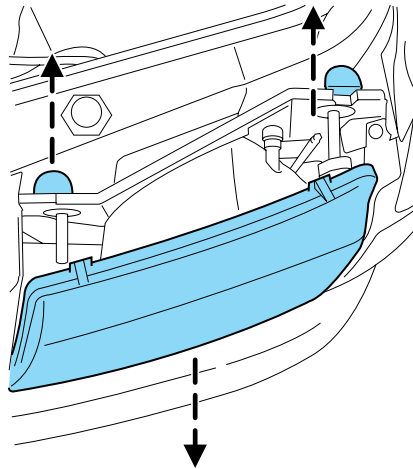

3. Disconnect the electrical connector by pushing the center tab and pulling down.
4. Remove the old bulb by turning counterclockwise to unlock and pull it out.

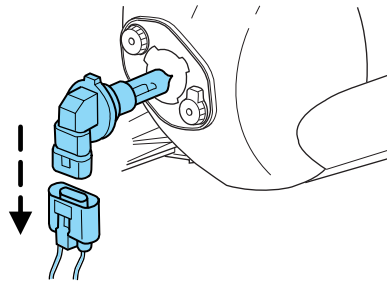

 Handle a halogen headlamp bulb carefully and keep out of children's reach. Grasp the bulb only by its plastic base and do not touch the glass. The oil from your hand could cause the bulb to break the next time the headlamps are operated.

Reverse steps to reinstall bulb(s).

Replacing front parking lamp/turn signal/sidemarker bulbs

1. Turn off the headlamp switch to off.
2. Remove headlamp screw from the bulb assembly.
3. Disengage lamp assembly.

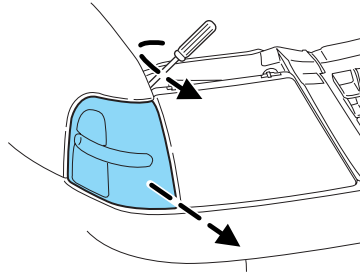

4. Rotate the bulb socket counterclockwise and remove it from the lamp assembly.
5. Pull the bulb straight out of the socket.

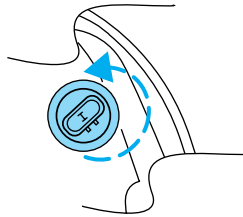

Reverse steps to reinstall bulb(s).

Replacing tail/brake/turn/backup lamp bulbs

1. Turn the headlamp switch to OFF and open the liftgate.
2. Remove the two screws from the lamp assembly.
3. Remove the lamp assembly.
4. Rotate the bulb socket counterclockwise and remove it from the lamp assembly.
5. Pull the bulb straight out of the socket.

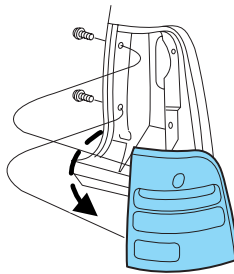

Reverse steps to reinstall bulb(s).

Lights

Replacing foglamp bulbs

1. Make sure the headlamp switch is in the OFF position.
 2. Remove the plastic splash shield by removing the two screws on the front of the fenderwell.
 3. Remove the bulb socket from the foglamp by turning it counterclockwise.
 4. Disconnect the electrical connector.
- Reverse steps to reinstall bulb(s).

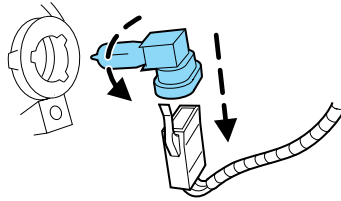

Replacing license plate lamp bulbs

1. Make sure the headlamp switch is in the OFF position and then remove two screws and the license plate lamp assembly.
2. Remove the bulb socket from the lamp assembly by turning counterclockwise and pull the bulb straight out.

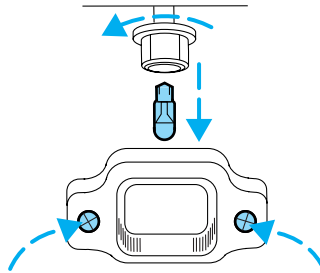

Reverse steps to reinstall bulb(s).

Replacing high-mount brakelamp bulb

1. Remove the two screws and lamp assembly from vehicle.
2. Remove the bulb socket from the lamp assembly by depressing the snaps and pull the bulb straight out.

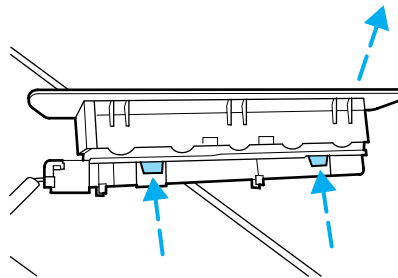

Reverse steps to reinstall bulb(s).

Driver Controls

MULTI-FUNCTION LEVER

Windshield wiper: Rotate the end of the control away from you to increase the speed of the wipers; rotate towards you to decrease the speed of the wipers.

Speed dependent wipers: When the wiper control is on, the speed of the wipers will automatically adjust with the vehicle speed. The faster your vehicle is travelling the faster the wipers will go.

Windshield washer: Push the end of the stalk:

- briefly: causes a single swipe of the wipers without washer fluid.
- a quick push and hold: the wipers will swipe three times with washer fluid.
- a long push and hold: the wipers and washer fluid will be activated for up to ten seconds.

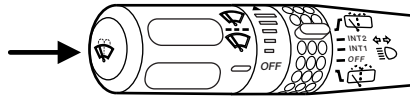
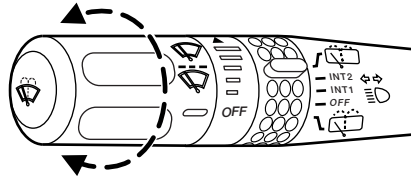

Rear window wiper/washer controls

For rear wiper operation, rotate the rear window wiper and washer control to the desired position. Select:

INT 1 — 3–4 second interval rear wiper.

INT 2 — 8–10 second interval rear wiper.

OFF — Rear wiper and washer off.

For rear wash cycle, rotate (and hold as desired) the rear wiper/washer control to either  position.

From either position, the control will automatically return to the INT 2 or OFF position.

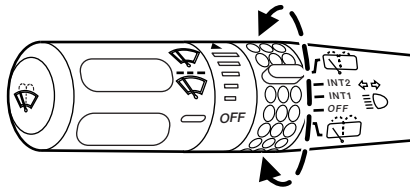

Driver Controls

Changing the wiper blades

1. Pull the wiper arm away from the vehicle. Turn the blade at an angle from the wiper arm. Push the lock pin manually to release the blade and pull the wiper blade down toward the windshield to remove it from the arm.

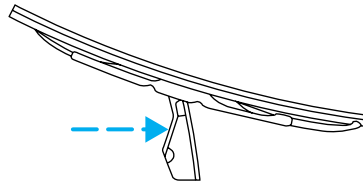

2. Attach the new wiper to the wiper arm and press it into place until a click is heard.

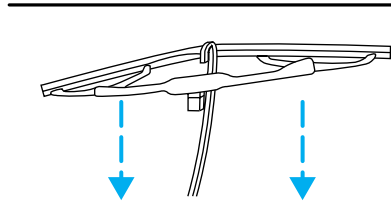

Replace wiper blades at least once per year for optimum performance.

Poor wiper quality can sometimes be improved by cleaning the wiper blades, refer to *Windows and wiper blades* in the *Cleaning* chapter.

To prolong the life of the wiper blades, it is highly recommended to scrape off the ice on the windshield before turning on the wipers. The layer of ice has many sharp edges and can damage the micro edge of the wiper rubber element.

TILT STEERING COLUMN

Pull the lever down to unlock the steering column. While the lever is in the down position, tilt the steering column to its desired orientation.

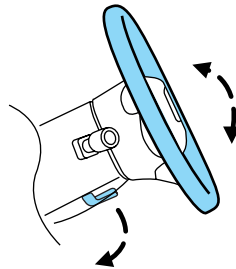

Driver Controls

Lift the lever back to its original position to lock the steering column.

 Never adjust the steering column when the vehicle is moving.

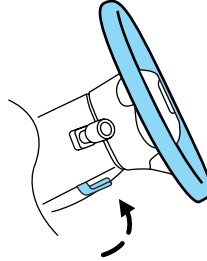

CENTER CONSOLE

Your vehicle may be equipped with a variety of console features. These include:

- Utility compartment with cassette/compact disc storage
- Auxiliary power point
- Cupholders
- Tissue box holder (located on underside of console lid)
- Ash tray (if equipped)

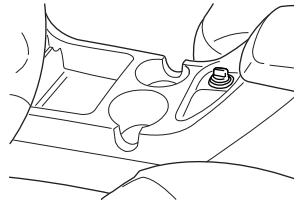

The rear side of the console may incorporate the following features:

- Air vents
- Cupholders (will pull up with break away feature)
- Rear power point

 Use only soft cups in the cupholder. Hard objects can injure you in a collision.

Driver Controls

Cell phone use

The use of Mobile Communications Equipment has become increasingly important in the conduct of business and personal affairs. However, drivers must not compromise their own or others' safety when using such equipment. Mobile Communications can enhance personal safety and security when appropriately used, particularly in emergency situations. Safety must be paramount when using mobile communications equipment to avoid negating these benefits.

Mobile Communication Equipment includes, but is not limited to cellular phones, pagers, portable email devices, in-vehicle communications systems, telematics devices and portable two-way radios.



A driver's first responsibility is the safe operation of the vehicle. The most important thing you can do to prevent a crash is to avoid distractions and pay attention to the road. Wait until it is safe to operate Mobile Communications Equipment.

Rear center console features (if equipped)

The rear center console incorporates the following features:

- Utility compartment
- Cupholders
- Flip forward armrest to provide a flat load floor

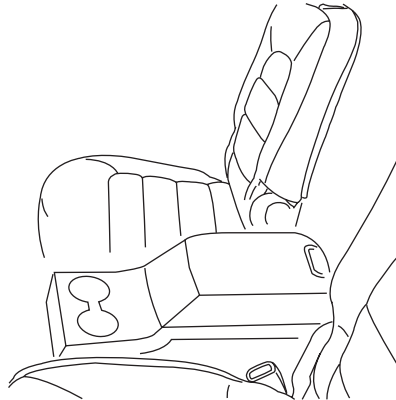

OVERHEAD CONSOLE (IF EQUIPPED)

The appearance of your vehicle's overhead console will vary according to your option package.

Driver Controls

Storage compartment

Press the latch to open the storage compartment.

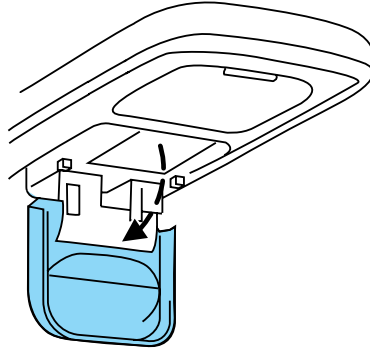

Installing a garage door opener (if equipped)

The storage compartment can be converted to accommodate a variety of aftermarket garage door openers:

- Place the VELCRO® hook onto the side of the aftermarket transmitter opposite of the button.
- Place the transmitter into storage compartment, button down.

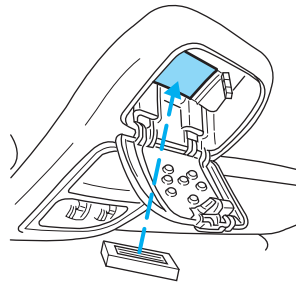

- Place the provided height adaptors onto the back of the door as needed.
- Close the door.
- Press the depression in the door to activate the transmitter.

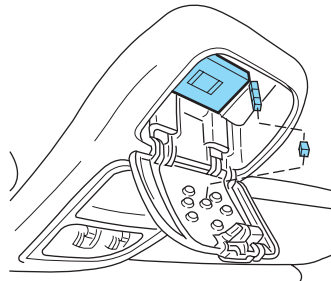

Driver Controls

Illuminated visor mirror (if equipped)

Lift the mirror cover to turn on the visor mirror lamps.

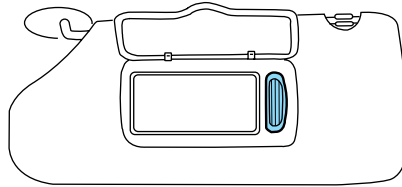

Slide on rod feature

Rotate the visor towards the side window and extend it rearward for additional sunlight coverage.

Note: To stow the visor back into the headliner, visor must be retracted before moving it back towards the windshield.

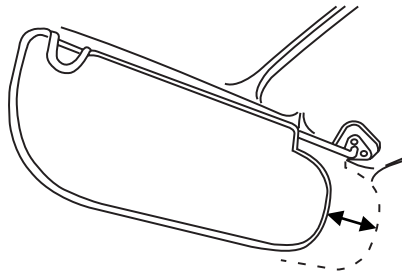

AUXILIARY POWER POINT (12VDC)

Power outlets are designed for accessory plugs only. Do not insert any other object in the power outlet as this will damage the outlet and blow the fuse. Do not hang any type of accessory or accessory bracket from the plug. Improper use of the power outlet can cause damage not covered by your warranty.

The auxiliary power point is located in the floor console.

Do not use the power point for operating the cigarette lighter element (if equipped).

To prevent the fuse from being blown, do not use the power point(s) over the vehicle capacity of 12 VDC/180W.

To prevent the battery from being discharged, do not use the power point longer than necessary when the engine is not running.

Always keep the power point caps closed when not being used.

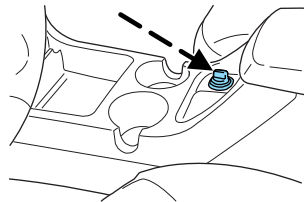

Driver Controls

Cigar/Cigarette lighter (if equipped)

Do not plug optional electrical accessories into the cigarette lighter socket.

Do not hold the lighter in with your hand while it is heating, this will damage the lighter element and socket. The lighter will be released from its heating position when it is ready to be used.

Improper use of the lighter can cause damage not covered by your warranty.

Rear auxiliary power point (if equipped)

A second auxiliary power point is located on the rear side of the console. It is accessible from the rear seats.

POWER WINDOWS



Do not leave children unattended in the vehicle and do not let children play with the power windows. They may seriously injure themselves.



When closing the power windows, you should verify they are free of obstructions and ensure that children and/or pets are not in the proximity of the window openings.

Press and hold the bottom part of the rocker switch to open the window. Press and hold the top part of the rocker switch to close the window.

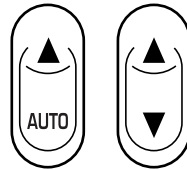

One touch down

Allows the driver's window to open fully without holding the control down. Press completely down on AUTO and release quickly. Press again to stop.

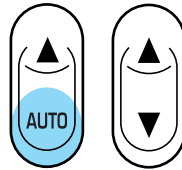

Driver Controls

Window lock

The window lock feature allows only the driver to operate the power windows.

To lock out all the window controls except for the driver's press the left side of the control. Press the right side to restore the window controls.

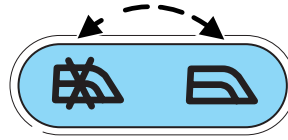

Accessory delay

With accessory delay, the window switches, audio system and moon roof may be used for up to ten minutes after the ignition switch is turned to the OFF position or until any door is opened.

POWER SIDE VIEW MIRRORS

The ignition must be in the ACC or ON position to adjust the power side view mirrors.

To adjust your mirrors:

1. Rotate the control clockwise to adjust the right mirror and rotate the control counterclockwise to adjust the left mirror.
2. Move the control in the direction you wish to tilt the mirror.
3. Return to the center position to lock mirrors in place.



Heated outside mirrors (if equipped)

Both mirrors are heated automatically to remove ice, mist and fog when the rear window defrost is activated.

Do not remove ice from the mirrors with a scraper or attempt to readjust the mirror glass if it is frozen in place. These actions could cause damage to the glass and mirrors.

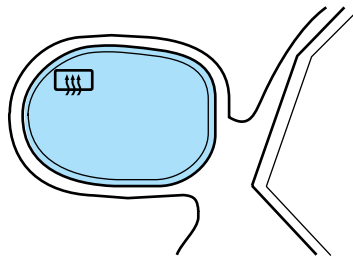

Driver Controls

Fold-away mirrors

Pull the side mirrors in carefully when driving through a narrow space, like an automatic car wash.

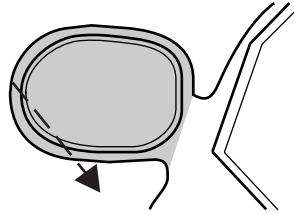

Automatic dimming rear view mirror

Your vehicle may be equipped with an inside rear view mirror with an auto-dimming feature. When the auto-dimming mirror is turned on, as indicated by an illuminated green LED to the left of the button on mirror, it will detect bright lights (glare) from behind the vehicle, and will change from the normal, high reflective state, to the darkened state to minimize glare.

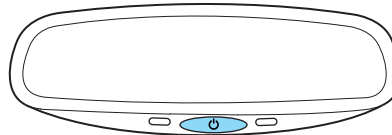

When the auto-dimming mirror is turned on, it will automatically return to the normal, high reflective, state whenever the vehicle is placed in R (Reverse) to ensure a clear view while backing up.

Do not block the sensor located to the right of the mirror button or the sensor located on the back side of the mirror as this may impair mirror performance.

POWER ADJUSTABLE FOOT PEDALS (IF EQUIPPED)

The accelerator and brake pedal should only be adjusted when the vehicle is stopped and the gearshift lever is in the P (Park) position.

Press and hold the rocker control to adjust accelerator and brake pedal toward you or away from you.

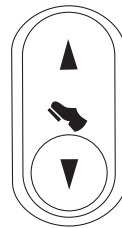

The adjustment allows for approximately 3 inches (71–76 mm) of maximum travel.

Driver Controls



Never adjust the accelerator and brake pedal with feet on the pedals while the vehicle is moving.

SPEED CONTROL (IF EQUIPPED)

With speed control set, you can maintain a speed of 30 mph (48 km/h) or more without keeping your foot on the accelerator pedal. Speed control does not work at speeds below 30 mph (48 km/h).





Do not use the speed control in heavy traffic or on roads that are winding, slippery or unpaved.

Setting speed control

The controls for using your speed control are located on the steering wheel for your convenience.

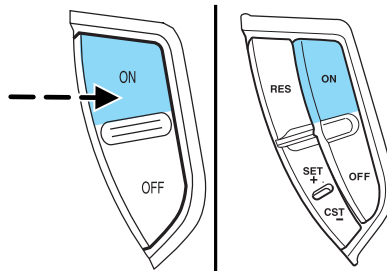
1. Press the ON control and release it.
2. Accelerate to the desired speed.



3. Press the SET + control and release it.
4. Take your foot off the accelerator pedal.
5. The indicator light  on the instrument cluster will turn on.

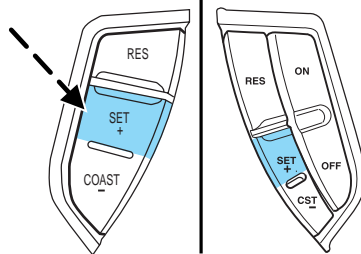

Note:

- Vehicle speed may vary momentarily when driving up and down a steep hill.
- If the vehicle speed increases above the set speed on a downhill, you may want to apply the brakes to reduce the speed.
- If the vehicle speed decreases more than 10 mph (16 km/h) below your set speed on an uphill, your speed control will disengage.

Driver Controls

Resuming a set speed

Press the RES (resume) control and release it. This will automatically return the vehicle to the previously set speed. The RES control will not work if the vehicle speed is not faster than 30 mph (48 km/h).

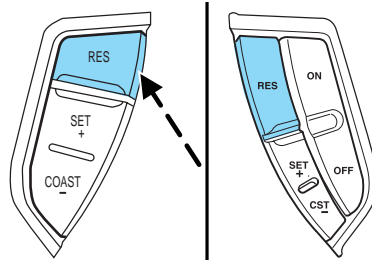

Increasing speed while using speed control

There are two ways to set a higher speed:

- Press and hold the SET + control until you get to the desired speed, then release the control. You can also use the SET + control to operate the Tap-Up function. Press and release this control to increase the vehicle set speed in small amounts by 1 mph (1.6 km/h).
- Use the accelerator pedal to get to the desired speed. When the vehicle reaches that speed press and release the SET + control.

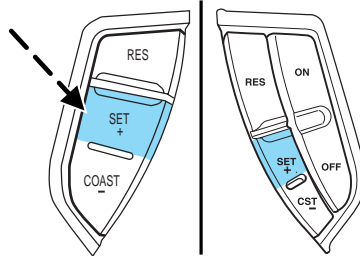

Reducing speed while using speed control

There are two ways to reduce a set speed:

- Press and hold the COAST/CST control until you get to the desired speed, then release the control. You can also use the COAST/CST control to operate the Tap-Down function. Press and release this control to decrease the vehicle set speed in small amounts by 1 mph (1.6 km/h).

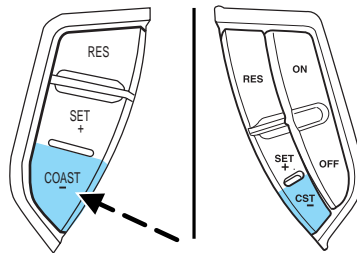

Driver Controls

- Depress the brake pedal until the desired vehicle speed is reached, press the SET + control.

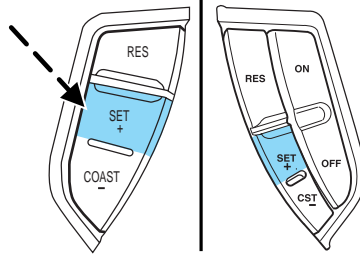

Turning off speed control

There are two ways to turn off the speed control:

- Depress the brake pedal. This will not erase your vehicle's previously set speed.
- Press the speed control OFF control.

Note: When you turn off the speed control or the ignition, your speed control set speed memory is erased.

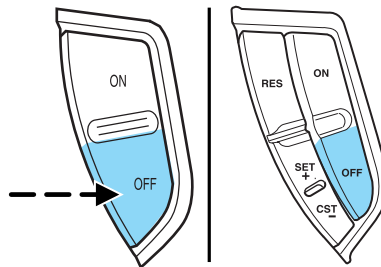

STEERING WHEEL CONTROLS (IF EQUIPPED)

These controls allow you to operate some radio and climate control features.

Driver Controls

Audio control features

Press  to select:

- AM, FM1, FM2,
- TAPE (if equipped),
- CD (if equipped), or
- DVD (if equipped).

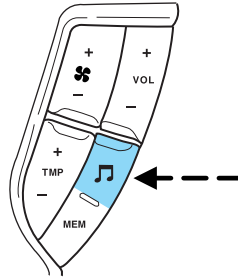

In AM, FM1, or FM2 mode:

- Press MEM to select preset stations within the selected radio band.

In Tape mode:

- Press MEM to select the next selection on the tape.

In CD mode:

- Press MEM to select the next selection on the CD.

In any mode:

- Press VOL + or - to adjust volume.

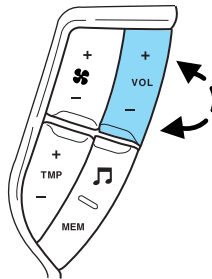
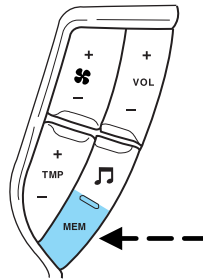

Driver Controls

Climate control features

Press TMP + or - to adjust temperature.

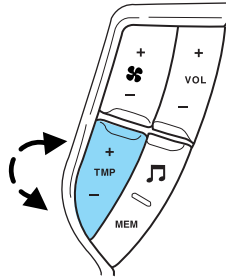

Press  + or - to adjust fan speed.

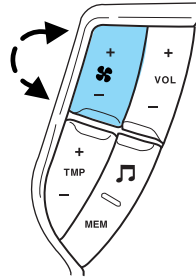

MOON ROOF (IF EQUIPPED)

You can move the glass panel of the moon roof back to open or tilt up to ventilate the vehicle.



Do not let children play with the moon roof or leave children unattended in the vehicle. They may seriously hurt themselves.

Driver Controls

To open the moon roof:

The moon roof is equipped with an automatic, one-touch, express opening feature. Press and release the rear portion of the control. To stop motion at any time during the one-touch opening, press the control again.

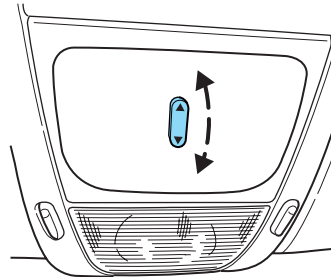

To close the moon roof:

Press and hold the front portion of the control until the glass panel stops moving. Once fully closed, the rear of the glass panel will appear higher than the front edge.

To vent:

To tilt the moon roof into the vent position (when the glass panel is closed), press and hold the front portion of the control. To close the moon roof from the vent position, press and hold the rear portion of the control until the glass panel stops moving.

If the battery is disconnected, discharged, or a new battery is installed, the moon roof needs to be opened to the vent position to reset the moon roof positions.

The moon roof has a sliding shade that can be opened or closed when the glass panel is shut. To close the shade, pull it toward the front of the vehicle.



When closing the moon roof, you should verify that it is free of obstructions and ensure that children and/or pets are not in the proximity of the moon roof opening.

HOMELINK® WIRELESS CONTROL SYSTEM (IF EQUIPPED)

The HomeLink® Wireless Control System, located on the overhead console, provides a convenient way to replace up to three hand-held transmitters with a single built-in device. This feature will learn the radio frequency codes of most transmitters to operate garage doors, entry gate operators, security systems, entry door locks, and home or office lighting.



When programming your HomeLink® Wireless Control System to a garage door or gate, be sure that people and objects are out of the way to prevent potential harm or damage.

Driver Controls

Do not use the HomeLink® Wireless Control System with any garage door opener that lacks safety stop and reverse features as required by U.S. federal safety standards (this includes any garage door opener model manufactured before April 1, 1982). A garage door which cannot detect an object, signaling the door to stop and reverse, does not meet current U.S. federal safety standards. For more information, contact HomeLink® at: **www.homelink.com** or **1-800-355-3515**.

Retain the original transmitter for use in other vehicles as well as for future programming procedures (i.e. new HomeLink® equipped vehicle purchase). It is also suggested that upon the sale of the vehicle, the programmed HomeLink® buttons be erased for security purposes, refer to *Programming* in this section.

Programming

Do not program HomeLink® with the vehicle parked in the garage.

Note: Some vehicles may require the ignition switch to be turned to the second (or “ACC”) position for programming and/or operation of the HomeLink®. It is also recommended that a new battery be placed in the hand-held transmitter of the device being programmed to HomeLink® for quicker training and accurate transmission of the radio-frequency signal.

1. Press and hold the two outside buttons releasing only when the indicator light begins to flash after 20 seconds. **Do not** repeat Step 1 to program additional hand-held transmitters to the remaining two HomeLink® buttons. This will erase previously programmed hand-held transmitter signals into HomeLink®.

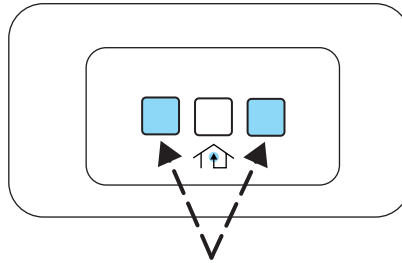

2. Position the end of your hand-held transmitter 1-3 inches (2-8 cm) away from the HomeLink® button you wish to program (located on your overhead console) while keeping the indicator light in view.

Driver Controls

3. Simultaneously press and hold both the HomeLink® and hand-held transmitter button. **Do not release the buttons until Step 4 has been completed.**

Some entry gates and garage door openers may require you to replace Step 3 with procedures noted in the “Gate Operator and Canadian Programming” section for Canadian residents.

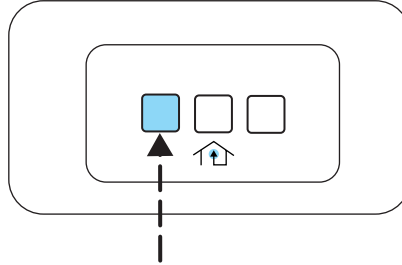

4. The indicator light will flash slowly and then rapidly. Release both buttons when the indicator light flashes rapidly. (The rapid flashing light indicates acceptance of the hand-held transmitters' radio frequency signals.)

5. Press and hold the just-trained HomeLink® button and observe the indicator light. If the light is constant, programming is complete and your device should activate when the HomeLink® button is pressed and released. **Note:** To program the remaining two HomeLink® buttons, begin with Step 2 in the “Programming” section — **do not** repeat Step 1.

Note: If the indicator light blinks rapidly for two seconds and then turns to a continuous light, proceed with Steps 6 through 8 to complete programming of a rolling code equipped device.

6. At the garage door opener receiver (motor-head unit) in the garage, locate the “learn” or “smart” button (usually near where the hanging antenna wire is attached to the unit).

7. Press and release the “learn” or “smart” button. (The name and color of the button may vary by manufacturer.)

Note: There are 30 seconds in which to initiate Step 8.

8. Return to the vehicle and firmly press, hold for two seconds and release the HomeLink® button. Repeat the press/hold/release sequence again, and, depending on the brand of the garage door opener (or other rolling code equipped device), repeat this sequence a third time to complete the programming.

HomeLink® should now activate your rolling code equipped device. To program additional HomeLink® buttons begin with Step 2 in the “Programming” section. For questions or comments, please contact HomeLink at **www.homelink.com** or **1-800-355-3515**.

Driver Controls

Gate Operator & Canadian Programming

During programming, your hand-held transmitter may automatically stop transmitting — not allowing enough time for HomeLink® to accept the signal from the hand-held transmitter.

After completing Steps 1 and 2 outlined in the “Programming” section, replace Step 3 with the following:

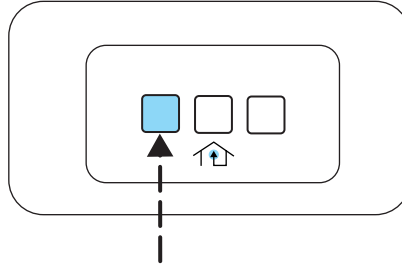

Note: If programming a garage door opener or gate operator, it is advised to unplug the device during the “cycling” process to prevent overheating.

- Continue to press and hold the HomeLink® button (note Step 3 in the “Programming” section) while you press and release — **every two seconds** (“cycle”) your hand-held transmitter until the frequency signal has been accepted by the HomeLink®. The indicator light will flash slowly and then rapidly after HomeLink® accepts the radio frequency signal.
- Proceed with Step 4 in the “Programming” section.

Operating the HomeLink® Wireless Control System

To operate, simply press and release the appropriate HomeLink® button. Activation will now occur for the trained product (garage door, gate operator, security system, entry door lock, or home or office lighting etc.). For convenience, the hand-held transmitter of the device may also be used at any time. In the event that there are still programming difficulties, contact HomeLink® at **www.homelink.com** or **1-800-355-3515**.

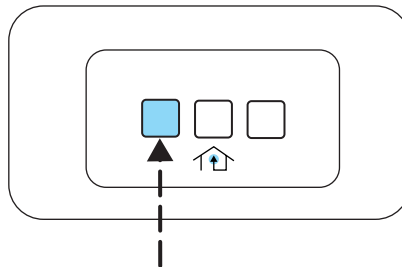

Driver Controls

Erasing HomeLink® buttons

To erase the three programmed buttons (individual buttons cannot be erased):

- Press and hold the two outer HomeLink® buttons until the indicator light begins to flash—after 20 seconds. Release both buttons. Do not hold for longer than 30 seconds.

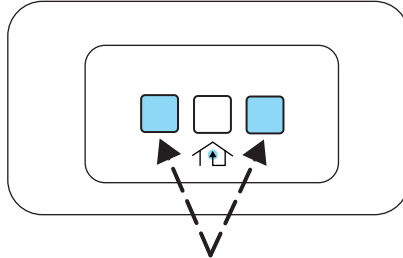

HomeLink® is now in the train (or learning) mode and can be programmed at any time beginning with Step 2 in the “Programming” section.

Reprogramming a single HomeLink® button

To program a device to HomeLink® using a HomeLink® button previously trained, follow these steps:

1. Press and hold the desired HomeLink® button. **Do NOT** release the button.
2. The indicator light will begin to flash after 20 seconds. Without releasing the HomeLink® button, follow Step 2 in the “Programming” section.

For questions or comments, contact HomeLink® at www.homelink.com or **1-800-355-3515**.

ELECTRONIC COMPASS/TEMPERATURE DISPLAY (IF EQUIPPED)

Outside air temperature

The outside temperature display is contained in the instrument cluster and displays all the time. If equipped with the DATC climate control system, the outside temperature will be displayed there.

For more information, refer to *Dual automatic temperature control (DATC)* in the *Climate Controls* chapter

To turn the display off or change the display from English to metric see your dealer.



Driver Controls

Compass

The compass reading may be affected when you drive near large buildings, bridges, power lines and powerful broadcast antennas. Magnetic or metallic objects placed in, on or near the vehicle may also affect compass accuracy.

Usually, when something affects the compass readings, the compass will correct itself after a few days of operating your vehicle in normal conditions. If the compass still appears to be inaccurate, a manual calibration may be necessary. Refer to *Compass calibration adjustment* in this section.

Most geographic areas (zones) have a magnetic north compass point that varies slightly from the northerly direction on maps. This variation is four degrees between adjacent zones and will become noticeable as the vehicle crosses multiple zones. A correct zone setting will eliminate this error. Refer to *Compass zone adjustment* in this section.

Compass zone adjustment

1. Determine which magnetic zone you are in for your geographic location by referring to the zone map.
2. Turn ignition to the ON position.
3. Locate compass sensor mounted at base of mirror.
4. Press the button on the top of the compass module until ZONE appears in the instrument cluster display.
5. Release pressure on the button and then slowly press it down again.

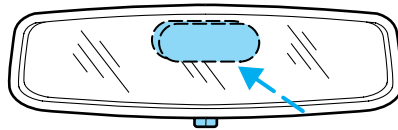
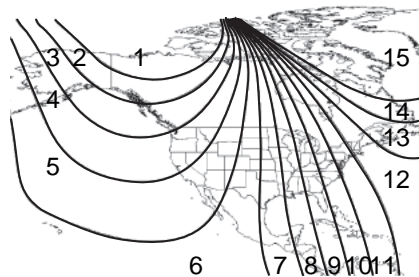

Driver Controls

6. Continue to press until ZONE appears in the instrument cluster display, then release. The display should show the current zone number.



7. Press until the desired zone number appears. The display will flash and then return to normal operation. The zone is now updated.

Compass calibration adjustment

Perform this adjustment in an open area free from steel structures and high voltage lines:

For optimum calibration, turn off all electrical accessories (heater/air conditioning, wipers, etc.) and make sure all vehicle doors are shut.

1. Start the vehicle.
2. Locate compass sensor mounted at base of mirror.

3. Press the button on the top of the compass module until ZONE appears in the instrument cluster display. Continue to hold down until ZONE disappears and CAL is displayed (approximately eight seconds) and release.



4. Drive the vehicle slowly (less than 5 km/h [3 mph]) in circles until CAL indicator turns off (4–5 complete circles).
5. The compass is now calibrated.

MESSAGE CENTER (IF EQUIPPED)

With the ignition in the ON position, the message center, located on your instrument cluster, displays important vehicle information

through a constant monitor of vehicle systems. You may select

display features on the message center for a display of status preceded by a brief indicator chime. The system will also notify you of potential vehicle problems with a display of system warnings followed by a long indicator chime.

MESSAGE CENTER

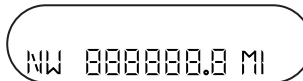

Driver Controls

Selectable features

Reset

Press this control to select and reset functions shown in the INFO menu and SETUP menu.

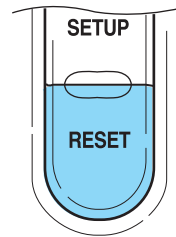

Info menu

This control displays the following control displays:

- Odometer/Compass
- Trip odometer/Odometer/Compass
- Average Fuel Economy
- Trip Elapsed Drive Time
- Distance to Empty

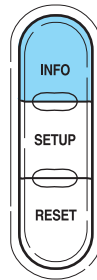

Odometer/Trip odometer

Refer to *Gauges* in the *Instrument Cluster* chapter.

Compass display

The compass reading may be affected when you drive near large buildings, bridges, power lines and powerful broadcast antenna. Magnetic or metallic objects placed in, on or near the vehicle may also affect compass accuracy.

Usually, when something affects the compass readings, the compass will correct itself after a few days of operating your vehicle in normal conditions. If the compass still appears to be inaccurate, a manual calibration may be necessary. Refer to *Compass zone/calibration adjustment* in this section.

Most geographic areas (zones) have a magnetic north compass point that varies slightly from the northerly direction on maps. This variation is four

Driver Controls

degrees between adjacent zones and will become noticeable as the vehicle crosses multiple zones. A correct zone setting will eliminate this error. Refer to *Compass zone/calibration adjustment* in this section.

Compass zone/calibration adjustment

Perform this adjustment in an open area free from steel structures and high voltage lines.

For optimum calibration, turn off all electrical accessories (heater/air conditioning, wipers, etc.) and make sure all vehicle doors are shut.

1. Turn ignition to the ON position.
2. Start the engine.
3. Determine your magnetic zone by referring to the zone map.
4. From Info menu, select the Compass/Odometer function. (Do not select Trip, DTE, or AFE. The top of the message center must be blank).

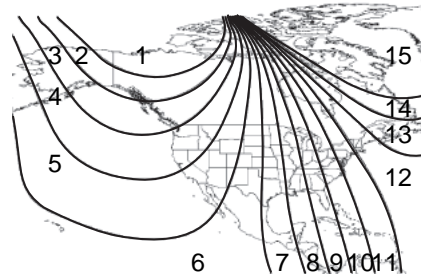

5. Press and hold the RESET and SETUP control until the message center display changes to show the current zone setting.

RESET FOR ZONE
INFO TO EXIT

6. Release the RESET AND SETUP control, then slowly press RESET down again.

SETUP ZONE XX
RESET IF DONE

7. Press the SETUP control repeatedly until the correct zone setting for your geographic location is displayed on the message center. To exit the zone setting mode press and release the RESET control.

8. Press the RESET control to start the compass calibration function.

RESET FOR CAL
INFO TO EXIT

Driver Controls

9. Slowly drive the vehicle in a circle (less than 3 mph [5 km/h]) until the CIRCLE SLOWLY TO CALIBRATE indicator changes to CALIBRATION COMPLETED. This will take up to three circles to complete calibration.



CIRCLE SLOWLY
TO CALIBRATE

10. The compass is now calibrated.

Average fuel economy (AFE)

Select this function from the INFO menu to display your average fuel economy in miles/U.S. gallon or liters/100 km.



XX.X MPG

If you calculate your average fuel economy by dividing gallons of fuel used by 100 miles traveled (kilometers traveled by liters used), your figure may be different than displayed for the following reasons:

- Your vehicle was not perfectly level during fill-up
- Differences in the automatic shut-off points on the fuel pumps at service stations
- Variations in top-off procedure from one fill-up to another
- Rounding of the displayed values to the nearest 0.1 gallon (liter)

1. Drive the vehicle at least 8 km (5 miles) with the speed control system engaged to display a stabilized average.

2. Record the highway fuel economy for future reference.

It is important to press the RESET control after setting the speed control to get accurate highway fuel economy readings.

Average fuel economy for FFV-equipped vehicles

Upon refueling, your vehicle needs to determine the percentage of Ethanol in the fuel. For the first several minutes, or few miles of driving, the message "COMPUTING FUEL" may appear in the message center. The correct fuel economy will appear in the message center following calculation.

Driver Controls

Trip elapsed drive time

Select this function from the INFO menu to display a timer.

To operate the Trip Elapsed Drive Time perform the following:

1. Press and release RESET in order to start the timer.
2. Press and release RESET to pause the timer.
3. Press and hold RESET for 2 seconds in order to reset the timer.



TIME 00:00:00
XX XXX MI

Distance to empty (DTE)

Selecting this function from the INFO menu estimates approximately how far you can drive with the fuel remaining in your tank under normal driving conditions.

Remember to turn the ignition OFF when refueling to allow this feature to correctly detect the added fuel.

The DTE function will display LOW FUEL LEVEL and sound a tone for one second when you have approximately 50 miles (80 km) to empty. If you RESET this warning message, this display and tone will return within 10 minutes.

DTE is calculated using a running average fuel economy, which is based on your recent driving history of 500 miles (800 km). This value is not the same as the average fuel economy display. The running average fuel economy is reinitialized to a factory default value if the battery is disconnected.



XXX MILES TO E
NW 000000.0 MI

Distance to empty for FFV-equipped vehicles

Upon refueling, your vehicle needs to determine the percentage of Ethanol in the fuel. For the first several minutes, or few miles of driving, the message "COMPUTING FUEL" may appear in the message center. The correct distance to empty will appear in the message center following calculation.

Driver Controls

Setup menu

Press this control for the following displays:

- Autolock
- Easy Entry/Exit
- Autolamp Delay
- Oil Change
- Language
- Units (English/Metric)
- System Check

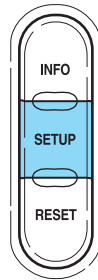

Autolocks

1. Select this function from the SETUP control for the current display mode.
2. Press the RESET control to turn the autolocks ON or OFF.

AUTO LOCKS
< ON >OFF

Easy entry/exit (if equipped)

1. Select this function from the SETUP control for the current display mode.
2. Press the RESET control to turn the easy entry/exit feature ON or OFF. For more information refer to *Memory Seat/Adjustable Pedals/Easy entry/exit feature* in the *Seating and Safety Restraints* chapter.

EASY EXIT SEAT
< ON >OFF

Autolamp delay (if equipped)

1. Select this function from the SETUP control for the current display mode.
2. Press the RESET control to select the autolamp delay time.

AUTOLAMP
DELAY = XXX SEC

Driver Controls

Oil Change

1. Select this function from the SETUP control for the current display mode.
2. Press the RESET control to reset oil change.

PRESS RESET
AT OIL CHANGE

Language

1. Select this function from the SETUP menu for the current language to be displayed.
2. Pressing the RESET control cycles the message center through each of the language choices.
3. Press and hold the RESET control to set the language choice.

ENGLISH
RESET FOR NEW

FOR ENGLISH
HOLD RESET

SET TO
ENGLISH

Units (English/Metric)

1. Select this function from the SETUP menu for the current units to be displayed.
2. Press the RESET control to change from English to Metric.

UNITS
< ENG > METRIC

System check

Selecting this function from the SETUP menu causes the message center to cycle through each of the systems being monitored. For each of the monitored systems, the message center will indicate either an OK message or a warning message for three seconds.

Pressing the RESET control cycles the message center through each of the systems being monitored.

PRESS RESET
FOR SYS CHECK

Driver Controls

The sequence of the system check report and how it appears in the message center is as follows:

1. FUEL LEVEL
2. WASHER FLUID LEVEL
3. OIL LIFE IN XX%
4. ADVTRAC
5. ENGINE TEMP
6. OIL PRESSURE
7. TIRE PRESSURE SYSTEM (if equipped)
8. BRAKE FLUID LEVEL
9. CHARGING SYSTEM

System warnings

System warnings alert you to possible problems or malfunctions in your vehicle's operating systems.

In the event of a multiple warning situation, the message center will cycle the display to show all warnings by displaying each one for several seconds.

The message center will display the last selected feature if there are no more warning messages. This allows you to use the full functionality of the message center after you acknowledge the warning by pressing the RESET control and clearing the warning message.

Warning messages that have been reset are divided into three categories:

- They will reappear on the display every minute from the reset.
- They will reappear on the display ten minutes from the reset.
- They will not reappear until an ignition OFF-ON cycle has been completed.

This acts as a reminder that these warning conditions still exist within the vehicle.

Driver Controls

Warning display	Status
Check engine temperature	Warning returns after 10 minutes
Transmission overheated	
Check transmission	
Low fuel level	
Check fuel cap	
Check charging system	
Low brake fluid level	
Low oil pressure	
Warning-tire very low (if equipped)	
ETC-engine failsafe mode	
Check tire pressure (if equipped)	
Tire pressure monitor fault (if equipped)	
Tire pressure sensor fault (if equipped)	
Check AdvanceTrac® (if equipped)	
Advtrac off t/c on (if equipped)	
Low washer fluid level	
Door ajar	
Change oil soon	
Oil change required	

CHECK ENGINE TEMPERATURE. Displayed when the engine coolant is overheating. Stop the vehicle as soon as safely possible, turn off the engine and let it cool. Check the coolant and coolant level. Refer to *Engine coolant* in the *Maintenance and Specifications* chapter. If the warning stays on or continues to come on, contact your dealer as soon as possible.

TRANSMISSION OVERHEATED. Indicates the transmission is overheating. This warning may appear when towing heavy loads or when driving in a low gear at a high speed for an extended period of time. Stop the vehicle as soon as safely possible, turn off the engine and let it cool. Refer to *Transmission fluid* in the *Maintenance and Specifications* chapter. If the warning stays on or continues to come on, contact your dealer for transmission service as soon as possible.

CHECK TRANSMISSION. Indicates the transmission is not operating properly. If this warning stays on, contact your dealer as soon as possible.

Driver Controls

LOW FUEL LEVEL. Displayed as an early reminder of a low fuel condition.

CHECK FUEL CAP. Displayed when the fuel filler cap is not properly installed. Check the fuel filler cap for proper installation. Refer to *Fuel filler cap* in the *Maintenance and Specifications* chapter.

ETC-ENGINE FAILSAFE MODE. Displayed when the engine has defaulted to a “limp-home” operation. If the warning stays on or continues to come on, contact your dealer as soon as possible.

CHECK CHARGING SYSTEM. Displayed when the electrical system is not maintaining proper voltage. If you are operating electrical accessories when the engine is idling at a low speed, turn off as many of the electrical loads as possible. If the warning stays on or comes on when the engine is operating at normal speeds, have the electrical system checked as soon as possible.

LOW BRAKE FLUID LEVEL. Indicates the brake fluid level is low and the brake system should be inspected immediately. Refer to *Brake fluid reservoir* in the *Maintenance and Specifications* chapter.

LOW OIL PRESSURE. Displayed when the engine oil level is low. If this warning message is displayed, check the level of the engine oil. Refer to *Engine oil* in the *Maintenance and Specifications* chapter for information about adding engine oil.

WARNING-TIRE VERY LOW (if equipped). Displayed when one or more road tires on your vehicle have very low pressure. When this warning message is displayed, a warning chime will sound reminding you to stop the vehicle as soon as safely possible to check your tires for proper air pressure, leaks and damage. Refer to *Inspecting and Inflating Your Tires* in the *Tires, Wheels and Loading* chapter.

CHECK TIRE PRESSURE (if equipped). Displayed when one or more tires on your vehicle have low tire pressure. Refer to *Inspecting and Inflating Your Tires* in the *Tires, Wheels and Loading* chapter.

TIRE PRESSURE MONITOR FAULT (if equipped). Displayed when the Tire Pressure Monitoring System is malfunctioning. If the warning stays on or continues to come on, have the system inspected by your servicing dealership.

TIRE PRESSURE SENSOR FAULT (if equipped). Displayed when a tire pressure sensor is malfunctioning, or your spare tire is in use. For more information on how the system operates under these conditions, refer to *Understanding Your Tire Pressure Monitoring System* in the *Tires, Wheels and Loading* chapter. If the warning stays on or continues to come on, have the system inspected by your servicing dealership.

Driver Controls

LOW WASHER FLUID LEVEL. Indicates the washer fluid reservoir is less than one quarter full. Check the washer fluid level. Refer to *Windshield washer fluid* in the *Maintenance and Specifications* chapter.

CHECK ADVANCETRAC® (if equipped). Displayed when the AdvanceTrac® with RSC system is not operating properly. If this message is displayed on the message center the AdvanceTrac® with RSC system will be partially operable. If this warning stays on while the engine is running, contact your dealer for service as soon as possible. For further information, refer to *AdvanceTrac® stability enhancement system* in the *Driving* chapter.

ADVTRAC OFF T/C ON (if equipped). Displayed on 4x4 vehicles only when 4x4 Low Range is selected. In this mode, the stability enhancement portion of the AdvanceTrac® with RSC is disabled, but the traction enhancement feature remains enabled. For further information, refer to *AdvanceTrac® stability enhancement system* in the *Driving* chapter.

DOOR AJAR. Displayed when a door or liftgate is not completely closed.

CHANGE OIL SOON/OIL CHANGE REQUIRED. Displayed when the engine oil life remaining is 5 percent or less. When oil life left is between 5% and 0%, the CHANGE OIL SOON message will be displayed. When oil life left reaches 0%, the OIL CHANGE REQUIRED message will be displayed.

An oil change is required whenever indicated by the message center and according to the recommended maintenance schedule. USE ONLY RECOMMENDED ENGINE OILS.

To reset the oil monitoring system to 100% after each oil change [approximately 5,000 miles (8,000 km) or 180 days] perform the following:

1. Press and release the SETUP control to display “PRESS RESET AT OIL CHANGE”.

PRESS RESET
AT OIL CHANGE

2. Press and release the RESET control to display “HOLD RESET TO CONFIRM”.

HOLD RESET
TO CONFIRM

Driver Controls

3. Press and hold the RESET control for 2 seconds and release. Oil life is set to 100% and “OIL LIFE SET TO 100%” is displayed.



OIL LIFE SET
TO 100%

After you have done steps 1 through 3, you can reset the oil monitoring system to your personalized oil life %:

4. Press RESET and SETUP controls at the same time for 2 seconds, to activate a service mode which will display “OIL LIFE XX% RESET TO ALTER”.



OIL LIFE XX%
RESET TO ALTER

5. Press RESET to decrement oil life by 10% down to 30% and back to 100%.

6. With your personalized OIL LIFE XX% displayed, press SETUP to continue the system check.

DATA ERR. These messages indicate improper operation of the vehicle network communication between electronic modules.

- Fuel computer
- Oil life
- Charging system
- Door sensor
- Washer fluid
- Brake fluid
- Compass
- Outside temperature
- Engine sensor

Contact your dealer as soon as possible if these messages occur on a regular basis.

Driver Controls

POSITIVE RETENTION FLOOR MAT

Position the driver floor mat so that the eyelet is over the pointed end of the retention post and rotate forward to lock in. Make sure that the mat does not interfere with the operation of the accelerator or the brake pedal. To remove the floor mat, reverse the installation procedure.

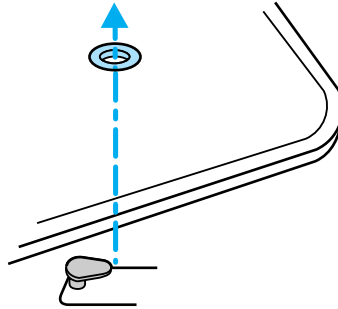

REAR LIFTGATE

The liftgate area is only intended for cargo, not passengers. You can open and close the liftgate from outside the vehicle. It cannot be opened from inside the cargo area.

- To open the liftgate window, press the control on the remote entry transmitter or, with the liftgate unlocked, push the control button on the **right side** under the license plate lamp shield.
- To open the liftgate, unlock the liftgate (with the power door locks, the remote entry or the keyless entry pad) and pull the **middle** lever under the license plate lamp shield.

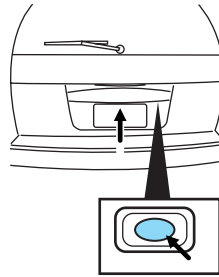

To lock the liftgate and the liftgate window, use the power door locks or press the door lock switch on the left side of the cargo area. To manually lock or unlock the liftgate, move the button located below the window down or up.

The liftgate door and window should be closed before driving. If not, possible damage may occur to your vehicle.

 Always close liftgate window before opening liftgate. Liftgate glass and liftgate should never be open at the same time. Failure to observe this warning may result in personal injury or damage to your vehicle.

Driver Controls

 Make sure the liftgate door and/or window are closed to prevent exhaust fumes from being drawn into the vehicle. This will also reduce the risk of passengers and cargo falling out.

CARGO COVER (IF EQUIPPED)

Your vehicle may be equipped with a cargo area cover that covers the luggage compartment of your vehicle.

To install the cover:

Push both ends of the cover into the depressions (right side first) in the trim panels behind the second row seat.

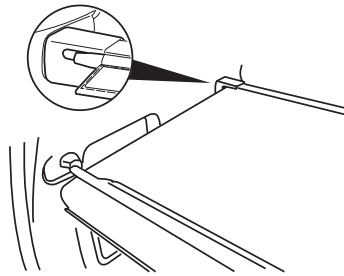

 To reduce the risk of injuries, the cargo area cover must be properly installed on the rear trim panels.

 Do not place any objects on the cargo area cover. They may obstruct your vision or strike occupants of the vehicle in the case of a sudden stop or collision.

Cargo management system

The cargo management system consists of storage compartments located in the floor of the rear cargo area.

7 passenger stowage:

1. To open, lift the release handle and the lid.
2. To close, lower the lid, lift the release handle and press down on the lid.

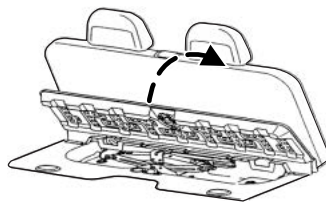

Driver Controls

5 passenger stowage:

When the lid is open, it will stand up on its own.

1. To open, lift the release handle and the lid.
2. To close, lower the lid, lift the release handle and press down on the lid.

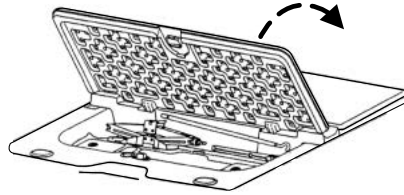

LUGGAGE RACK

Your vehicle is equipped with a roof rack. The maximum recommended load is 200 lbs (90 kg), evenly distributed. If it is not possible to distribute the load, position it as far rearward as possible. Use the tie down loops on the thumbwheels (if equipped) to secure the load.

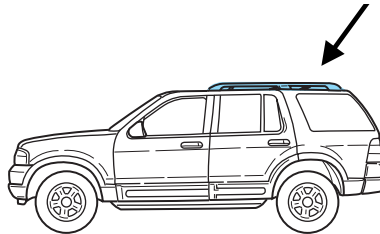

To adjust cross-bar position (if equipped):

1. Loosen the thumbwheel at both ends of the cross-bar (both cross-bars are adjustable).
2. Slide the cross-bar to the desired location.
3. Tighten the thumbwheel at both ends of the cross-bar.

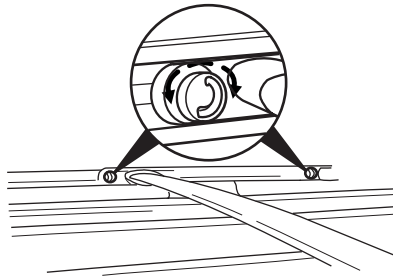

 Vehicles with a higher center of gravity such as utility and four-wheel drive vehicles handle differently than vehicles with a lower center of gravity. Utility and four-wheel drive vehicles are not designed for cornering at speeds as high as passenger cars any more than low-slung sport cars are designed to perform satisfactorily under off-road conditions. Avoid sharp turns, excessive speed and abrupt maneuvers in these vehicles. Failure to drive cautiously could result in an increase risk of loss of vehicle control, vehicle rollover, personal injury and death.

Locks and Security

KEYS

One key operates all the locks and starts the vehicle. Always carry a spare key with you in case of an emergency.

Your keys are programmed to your vehicle; using a non-programmed key will not permit your vehicle to start. If you lose your dealer supplied keys, replacement keys are available through your authorized dealer. Refer to the *SecuriLock[™] passive anti-theft system* section later in this chapter for more information.

POWER DOOR LOCKS

Press control to unlock all vehicle doors.

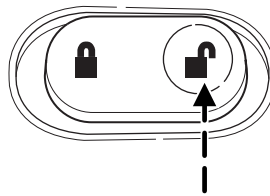

Press control to lock all vehicle doors.

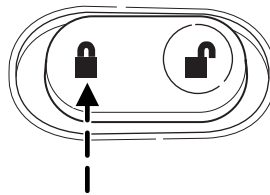

Liftgate

An additional power door lock can be accessed by opening the liftgate. The button is located either on the top of the left-hand quarter trim panel underneath the rear window, or on the bottom of the left-hand quarter trim panel. Press this button to lock or unlock all the doors.

Smart unlocking feature

The smart unlocking feature helps prevent you from locking yourself out of the vehicle. With the key in any ignition position, the driver's door will automatically unlock if it is locked using the power lock control on the driver's door panel while the driver's door is open.

Locks and Security

Childproof door locks

- When these locks are set, the rear doors cannot be opened from the inside.
- The rear doors can be opened from the outside when the doors are unlocked.

The childproof locks are located on rear edge of each rear door and must be set separately for each door. Setting the lock for one door will not automatically set the lock for both doors.

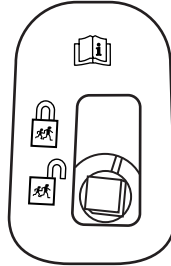

- Move lock control up to engage the childproof lock.
- Move control down to disengage childproof locks.

REMOTE ENTRY SYSTEM

This device complies with part 15 of the FCC rules and with RS-210 of Industry Canada. Operation is subject to the following two conditions: (1) This device may not cause harmful interference, and (2) This device must accept any interference received, including interference that may cause undesired operation.

Changes or modifications not expressly approved by the party responsible for compliance could void the user's authority to operate the equipment.

The typical operating range for your remote entry transmitter is approximately 33 feet (10 meters). A decrease in operating range could be caused by:

- weather conditions,
- nearby radio towers,
- structures around the vehicle, or
- other vehicles parked next to your vehicle.

Locks and Security

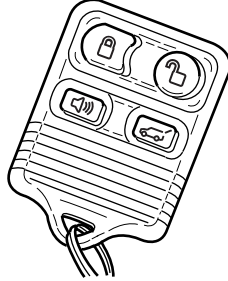

The remote entry system allows you to lock or unlock all vehicle doors and liftgate and open the liftgate window without a key.



The remote entry lock/unlock feature operates in any ignition position. The liftgate glass feature operates as long as the vehicle's speed is less than 3 mph (5 km/h). The panic feature operates with the key in the 1 (OFF/LOCK) or 2 (ACC) position.

If there is any potential remote keyless entry problem with your vehicle, ensure **ALL** remote entry transmitters are brought to the dealership, to aid in troubleshooting.

Unlocking the doors

1. Press  and release to unlock the driver's door. **Note:** The interior lamps will illuminate.
2. Press  and release again within three seconds to unlock all the doors.

The remote entry system activates the illuminated entry feature. This feature turns on the interior lamps for 25 seconds or until the ignition is turned to the 3 (ON) position. If the dome lamp control is in the **off** position the illuminated entry feature will not work.

The inside lights will not turn off if:

- they have been turned on using the dimmer control or
- any door is open.

The battery saver feature will turn off the interior lamps 30 minutes after the ignition is turned to the 1 (OFF/LOCK) position.

Locking the doors/liftgate

1. Press  and release to lock all the doors and liftgate. The lamps will flash. **Note:** If any door, the liftgate or the liftgate glass are not closed properly, the lamps will not flash.

100

Locks and Security

2. Press  and release again within three seconds to confirm that all the doors are closed and locked. **Note:** The doors will lock again, the horn will chirp and the lamps flash once.

Note: If any door, the liftgate or the liftgate glass are not closed properly, the horn will make two quick chirps.

Opening the liftgate window

Press  to unlatch the liftgate window.

Sounding a panic alarm

Press  to activate the alarm. The horn will sound and the parklamps will flash for a maximum of 3 minutes. Press again or turn the ignition to the 3 (ON) position to deactivate, or wait for the alarm to timeout in 3 minutes.

Note: The panic alarm will only operate when the ignition is in the 1 (OFF/LOCK) or 2 (ACC) position.

Memory seats/adjustable pedals/easy entry-exit feature (if equipped)

The remote entry system can also control the memory seat /adjustable pedals/easy entry-exit feature.

Press  to automatically move the seat and adjustable pedals to the desired memory position (the seat position corresponds to the transmitter being used).

Activating the memory seat feature

To activate this feature:

1. Position the seat and adjustable pedals to the position desired.
2. Press the SET control on the driver's door panel.
3. Within 5 five seconds, press one control on the remote transmitter and then press the 1 or 2 control on the driver's door panel to which you would like to associate with the seat and Driver 1 or Driver 2 positions.
4. Repeat this procedure for another remote transmitter if desired.

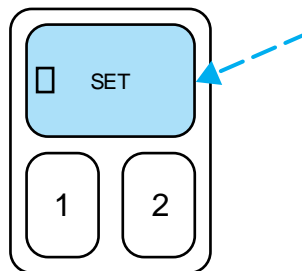

Locks and Security

Deactivating the memory seat feature

To deactivate this feature:

1. Press the SET control on the driver's door panel.
2. Within 5 five seconds, press any control on the remote transmitter which you would like to deactivate and then press the SET control on the driver's door panel.
3. Repeat this procedure for another remote transmitter if desired.

Replacing the battery

The remote entry transmitter uses one coin type three-volt lithium battery CR2032 or equivalent.

To replace the battery:

1. Twist a thin coin between the two halves of the remote entry transmitter near the key ring. **DO NOT TAKE THE RUBBER COVER AND CIRCUIT BOARD OFF THE FRONT HOUSING OF THE REMOTE ENTRY TRANSMITTER.**

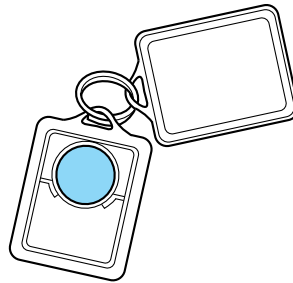

2. Do not wipe off any grease on the battery terminals on the back surface of the circuit board.

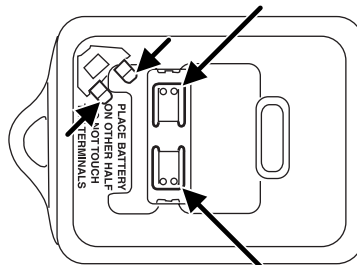

3. Remove the old battery. **Note:** Please refer to local regulations when disposing of transmitter batteries.
4. Insert the new battery. Refer to the diagram inside the remote entry transmitter for the correct orientation of the battery. Press the battery down to ensure that the battery is fully seated in the battery housing cavity.
5. Snap the two halves back together.

102

2005 Explorer (exp)
Owners Guide (post-2002-fmt)
USA (fus)

Locks and Security

Note: Replacement of the battery will **not** cause the remote transmitter to become deprogrammed from your vehicle. The remote transmitter should operate normally after battery replacement.

Replacing lost remote entry transmitters

If you would like to have your remote entry transmitter reprogrammed because you lost one, or would like to buy additional remote entry transmitters, you can either reprogram them yourself, or take **all remote entry transmitters** to your authorized dealer for reprogramming.

How to reprogram your remote entry transmitters

You must have **all remote entry transmitters** (maximum of four) available before beginning this procedure. If all remote entry transmitters are not present during the programming procedure, the transmitters that are not present during programming will no longer operate the vehicle.

To reprogram the remote entry transmitters:

1. Ensure the vehicle is electronically unlocked.
2. Put the key in the ignition.
3. Turn the key from the 1 (OFF/LOCK) position to 3 (ON).
4. Cycle eight times rapidly (within 10 seconds) between the 1 (OFF/LOCK) position and 3 (ON). **Note:** The eighth turn must end in the 3 (ON) position.
5. The doors will lock, then unlock, to confirm that the programming mode has been activated.
6. Within 20 seconds press any button on the remote entry transmitter. **Note:** If more than 20 seconds have passed you will need to start the procedure over again.
7. The doors will lock, then unlock, to confirm that this remote entry transmitter has been programmed.
8. Repeat Step 6 to program each additional remote entry transmitter.
9. Turn the ignition to the 1 (OFF/LOCK) position after you have finished programming all of the remote entry transmitters.
10. The doors will lock, then unlock, to confirm that the programming mode has been exited.

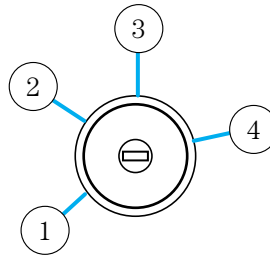

Locks and Security

Illuminated entry

The interior lamps illuminate when the remote entry system is used to unlock the door(s) or sound the personal alarm.

The illuminated entry system will turn off the interior lights if:

- the ignition is turned to the 3 (ON) position, or
- the remote transmitter lock control is pressed, or
- after 25 seconds of illumination.

The dome lamp control (if equipped) must **not** be set to the **off** position for the illuminated entry system to operate.

The inside lights will not turn off if:

- they have been turned on with the dimmer control, or
- any door is open.

The battery saver will shut off the interior lamps 10 minutes after the ignition has been turned to the 1 (OFF/LOCK) position.

KEYLESS ENTRY SYSTEM (IF EQUIPPED)

You can use the keyless entry keypad to:

- lock or unlock the doors without using a key.
- open the liftgate window.
- activate or deactivate the autolock feature.

The keypad can be operated with the factory set 5-digit entry code; this code is located on the owner's wallet card in the glove box, is marked on the computer module, and is available from your authorized dealer. You can also create your own 5-digit personal entry code. In the event the wallet card is lost, the factory set code cannot be reprogrammed.

When pressing the controls on the keypad, press the middle of the controls to ensure a good activation.



Locks and Security

Programming a personal entry code

To create your own personal entry code:

1. Enter the factory set code.
2. Within five seconds press the 1 • 2 on the keypad.
3. Enter your personal 5-digit code. Each number must be entered within five seconds of each other.
4. The doors will again lock then unlock to confirm that your personal keycode has been programmed to the module.

Tips:

- Do not set a code that uses five of the same number.
- Do not use five numbers in sequential order.
- The factory set code will work even if you have set your own personal code.
- If you set a second personal code it will erase your first personal code.

Erasing personal code

1. Enter the factory set 5-digit code.
2. Within five seconds, press the 1 • 2 on the keypad and release.
3. Press and hold the 1 • 2 for two seconds. This must be done within five seconds of completing Step 2.

Your personal code is now erased and only the factory set 5-digit code will work.

Anti-scan feature

If the wrong code has been entered 7 times (35 consecutive button presses), the keypad will go into an anti-scan mode. This mode disables the keypad for one minute and the keypad lamp will flash.

The anti-scan feature will turn off after:

- one minute of keypad inactivity.
- pressing the UNLOCK  control on the remote entry transmitter.
- the ignition is turned to the 3 (ON) position.

Unlocking and locking the doors, liftgate and liftgate window using keyless entry

To unlock the driver's door, enter the factory set 5-digit code or your personal code. Each number must be pressed within five seconds of each other. The interior lamps will illuminate.

Locks and Security

To unlock all doors and liftgate, press the 3 • 4 control within five seconds.

To open the liftgate window, press the 5 • 6 control within five seconds.

To lock all doors, liftgate and liftgate window, press the 7 • 8 and the 9 • 0 at the same time. **Note:** The driver's door must be closed. You **do not** need to enter the keypad code first.

Autolock

The autolock feature will lock all the doors, liftgate and liftgate window when:

- all the doors, the liftgate and liftgate window are closed,
- the ignition is in the 3 (ON) position,
- you shift into any gear putting the vehicle in motion, and
- the brake pedal is released and the vehicle attains a speed greater than 5 mph (8 km/h).

The autolock feature repeats when:

- any door, liftgate or liftgate window is opened then closed while the ignition is in the 3 (ON) position, and
- you put the vehicle in motion by releasing the brake pedal and the vehicle attains a speed greater than 5 mph (8 km/h).

Deactivating/activating autolock

Your vehicle comes with the autolock feature activated. There are four methods to enable/disable this feature: One is through your dealer, the second with a power door unlock/lock sequence, the third with the keypad, and the fourth by using the message center (if equipped).

Before following the activation or deactivation procedures, make sure that the anti-theft system is not armed, ignition is off, and all vehicle doors, liftgate and liftgate window are closed.

Locks and Security

Power door unlock/lock procedure

You must complete steps 1-5 within 30 seconds or the procedure will have to be repeated. If the procedure needs to be repeated, you must wait 30 seconds.

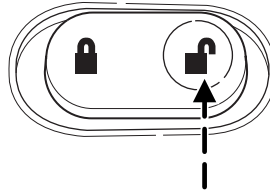

1. Turn the ignition to the 3 (ON) position.
2. Press the power door unlock control three times.
3. Turn the ignition from the 3 (ON) to the 1 (OFF/LOCK) position.
4. Press the power door unlock control three times.
5. Turn the ignition back to the 3 (ON) position. The horn will chirp.
6. Press the unlock control, then press the lock control. The horn will chirp once if autolock was deactivated or twice (one short and one long chirp) if autolock was activated.
7. Turn the ignition to the 1 (OFF/LOCK) position. The horn will chirp once to confirm the procedure is complete.

Keyless entry key pad procedure

1. Turn the ignition to the 1 (OFF/LOCK) position.
2. Close all the doors, the liftgate and liftgate window.
3. Enter 5-digit entry code
4. Press and hold the 7 • 8. While holding the 7 • 8 press the 3 • 4.
5. Release the 3 • 4.
6. Release the 7 • 8.

The user should receive a **horn chirp** to indicate the system has been disabled or a chirp followed by a honk to indicate the system has been enabled.

Message center procedure

For information on activating/deactivating the autolock feature using the vehicle's message center (if equipped), refer to *Message center* information in the *Driver Controls* chapter.

Locks and Security

SECURILOCK™ PASSIVE ANTI-THEFT SYSTEM

SecuriLock™ passive anti-theft system is an engine immobilization system. This system is designed to help prevent the engine from being started unless a **coded key programmed to your vehicle** is used. The use of the wrong type of coded key may lead to a “no-start” condition.

Your vehicle comes with two coded keys; additional coded keys may be purchased from your dealer. The dealer can program your spare keys to your vehicle or you can program the keys yourself. Refer to *Programming spare keys* for instructions on how to program the coded key.

Note: The SecuriLock™ passive anti-theft system is not compatible with non-Ford aftermarket remote start systems. Use of these systems may result in vehicle starting problems and a loss of security protection.

Note: Large metallic objects, electronic devices that are used to purchase gasoline or similar items, or a second coded key on the same key chain may cause vehicle starting issues. You need to prevent these objects from touching the coded key while starting the engine. These objects will not cause damage to the coded key, but may cause a momentary issue if they are too close to the key when starting the engine. If a problem occurs, turn the ignition off, remove all objects on the key chain away from the coded key and restart the engine.

Theft indicator

The theft indicator is located on top of the instrument panel.

- When the ignition is in the 1 (OFF/LOCK) position, the indicator will flash once every 2 seconds to indicate the SecuriLock™ system is functioning as a theft deterrent.
- When the ignition is in the 3 (ON) position, the indicator will glow for 3 seconds to indicate normal system functionality.

If a problem occurs with the SecuriLock™ system, the indicator will flash rapidly or glow steadily when the ignition is in the 3 (ON) position. If this occurs, the vehicle should be taken to an authorized dealer for service.

Locks and Security

Automatic arming

The vehicle is armed immediately after switching the ignition to the 2 (ACCESSORY) position.

The theft indicator will flash every two seconds when the vehicle is armed.

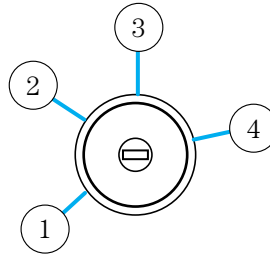

Automatic disarming

Switching the ignition to the 3 (ON) position with a **coded key** disarms the vehicle.

- The theft indicator will illuminate for three seconds and then go out.
- If the theft indicator stays on for an extended period of time or flashes rapidly, have the system serviced by your dealer.

Replacement keys

If your keys are lost or stolen and you don't have an extra coded key, you will need to have your vehicle towed to a dealership. The key codes need to be erased from your vehicle and new coded keys will need to be programmed.

Replacing coded keys can be very costly. Store an extra programmed key away from the vehicle in a safe place to help prevent any inconveniences. Please visit an authorized dealer to purchase additional spare or replacement keys.

Programming spare keys

You can program your own coded keys to your vehicle.

Tips:

- A maximum of eight keys can be coded to your vehicle.
- Only use SecuriLock[™] keys.
- You must have two previously programmed coded keys (keys that already operate your vehicle's engine) and the new unprogrammed key(s) readily accessible.
- If two previously programmed coded keys are not available, you must take your vehicle to your dealer to have the spare key(s) programmed.

Locks and Security

Please read and understand the entire procedure before you begin.

1. Insert the first previously programmed **coded key** into the ignition.

2. Turn the ignition from the 1 (OFF/LOCK) position to the 3 (ON) position. Keep the ignition in the 3 (ON) position for at least three seconds, but no more than 10 seconds.

3. Turn the ignition to the 1 (OFF/LOCK) position and remove the first **coded key** from the ignition.

4. Within ten seconds of turning the ignition to the 1 (OFF/LOCK) position, insert the second previously **coded key** into the ignition.

5. Turn the ignition from the 1 (OFF/LOCK) position to the 3 (ON) position. Keep the ignition in the 3 (ON) position for at least three seconds, but no more than 10 seconds.

6. Turn the ignition to the 1 (OFF/LOCK) position and remove the second previously programmed **coded key** from the ignition.

7. Within twenty seconds turning the ignition to the 1 (OFF/LOCK) position and removing the previously programmed **coded key**, insert the new unprogrammed key (new key/valet key) into the ignition.

8. Turn the ignition from the 1 (OFF/LOCK) position to the 3 (ON) position. Keep the ignition in the 3 (ON) position for at least three seconds but not more than 10 seconds.

9. Remove the newly programmed **coded key** from the ignition.

If the key has been successfully programmed it will start the vehicle's engine and the theft indicator light will illuminate for three seconds and then go out.

If the key was not successfully programmed, it will not start your vehicle's engine and the theft indicator light will flash on and off, and you may repeat Steps 1 through 5. If failure repeats, bring your vehicle to your dealer to have the new key(s) programmed.

To program additional new unprogrammed key(s), wait twenty seconds and then repeat this procedure from Step 1.

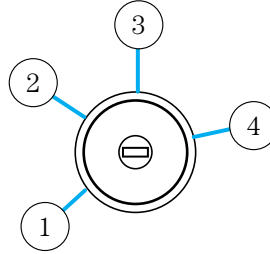

Seating and Safety Restraints

SEATING

Notes:



Reclining the seatback can cause an occupant to slide under the seat's safety belt, resulting in severe personal injuries in the event of a collision.



Do not pile cargo higher than the seatbacks to reduce the risk of injury in a collision or sudden stop.



Before returning the seatback to its original position, make sure that cargo or any objects are not trapped behind the seatback. After returning the seatback to its original position, pull on the seatback to ensure that it has fully latched. An unlatched seat may become dangerous in the event of a sudden stop or collision.

Adjustable head restraints

Head restraints help to limit head motion in the event of a rear collision. The seats in your vehicle have adjustable head restraints. Adjust your head restraint so that it is located directly or as close as possible behind your head.

The head restraints can be moved up and down.

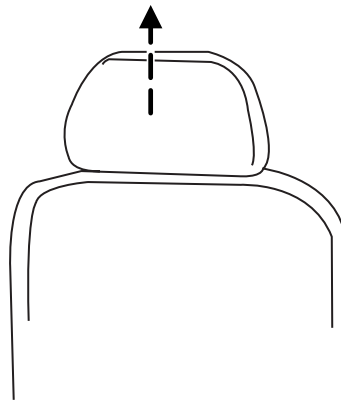

Seating and Safety Restraints

Push control to lower head restraint.

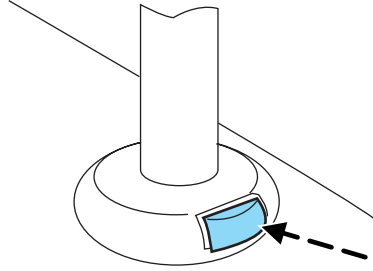

Adjusting the front manual seat (if equipped)



Never adjust the driver's seat or seatback when the vehicle is moving.



Always drive and ride with your seatback upright and the lap belt snug and low across the hips.

Lift handle to move seat forward or backward.

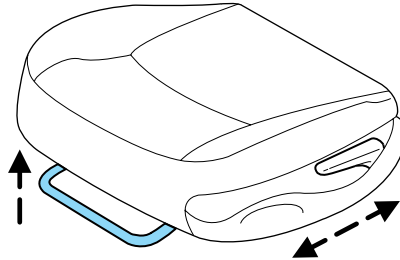

Pull lever up to adjust seatback.

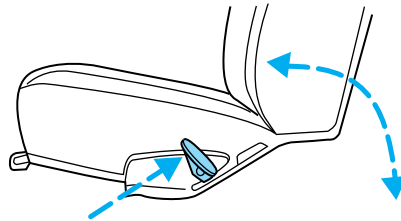

Seating and Safety Restraints

 Before returning the seatback to its original position, make sure that cargo or any objects are not trapped behind the seatback. After returning the seatback to its original position, pull on the seatback to ensure that it has fully latched. An unlatched seat may become dangerous in the event of a sudden stop or collision.

Using the power lumbar support (if equipped)

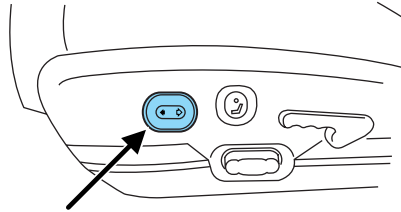

The power lumbar control is located on the outboard side of the seat.

Press one side of the control to adjust firmness.

Press the other side of the control to adjust softness.

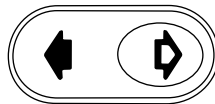

Adjusting the front power seat (if equipped)

The control is located on the outboard side of the seat cushion.

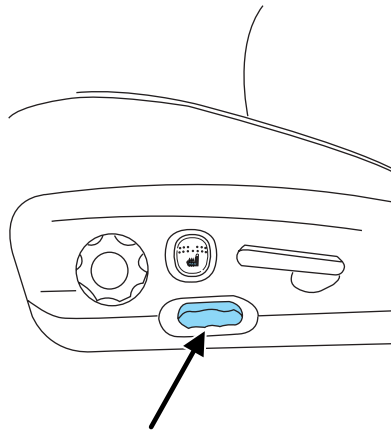

Seating and Safety Restraints

Press front to raise or lower the front portion of the seat cushion.

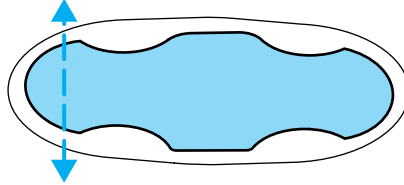

Press rear to raise or lower the rear portion of the seat cushion.

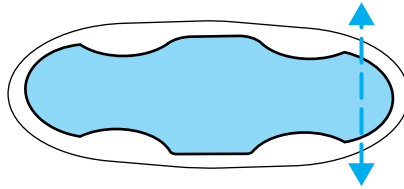

Press the control to move the seat forward, backward, up or down.

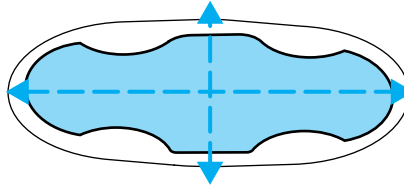

Memory seat/adjustable pedals/easy entry-exit feature (if equipped)

This system allows automatic positioning of the driver seat to three programmable positions.

The memory seat control is located on the driver door.

- To program position one, move the driver seat to the desired position using the seat controls. Press the SET control. The SET control indicator light will briefly illuminate. While the light is illuminated, press control 1.
- To program position two, repeat the previous procedure using control 2.

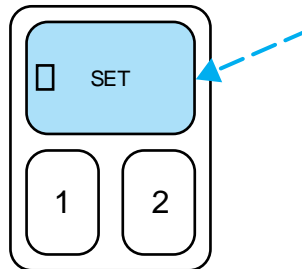

Seating and Safety Restraints

- To program position three, push buttons 1 and 2 simultaneously.

A position can only be set or recalled when the transmission gearshift is in P (Park) or N (Neutral). A memory seat position may be programmed at any time.

The memory seat positions are also recalled when you press your remote entry transmitter UNLOCK control.

The third position is recalled when both buttons are depressed.

To program the memory seat to remote entry transmitter, refer to *Memory seat/adjustable pedals/easy entry-exit feature (if equipped)* in the *Locks and Security* chapter.

The easy entry/exit feature automatically moves the drivers seat backwards slightly (if room is available) when the key is removed from the ignition. It will automatically move the seat forward to the original position when the key is inserted into the ignition.

Using the manual lumbar support

For more lumbar support, turn the lumbar support control toward the front of vehicle.

For less lumbar support, turn the lumbar support control toward the rear of vehicle.

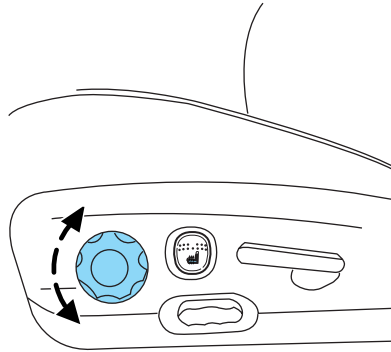

Seating and Safety Restraints

Heated seats (if equipped)

To operate the heated seats:

- Push control located on the seat to activate.
- Push again to deactivate.

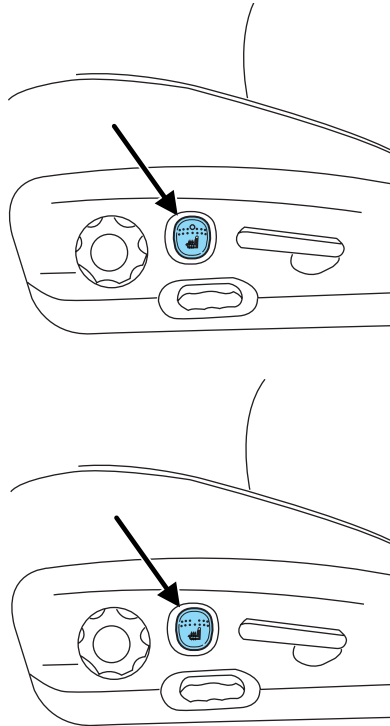

The heated seat icon in the Dual Automatic Temperature Control (DATC) will illuminate when activated.

REAR SEATS

Folding down the 60/40 rear seats (if equipped)

If the rear seat is equipped with adjustable head restraints, they should be placed in the full down position before folding the seat back down.

Seating and Safety Restraints

1. Pull upward on the release handle to cycle the seats to the load-floor position.
2. Rotate the seatback downward into the load floor position.
3. Press down on the top outboard area of the seatback until a click is heard. The seat is now latched in the floor position.

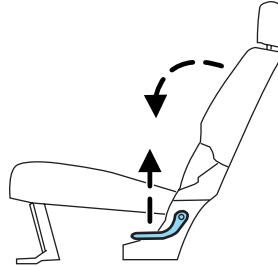

To return the seat to the upright position:

- Pull the release handle upward to unlatch the seat.
- Rotate the seatback upward until the seatback latches in the upright position. The seatback will click when it is locked into position.

Folding down the 40/20/40 rear seats or bucket seats

Ensure that the headrest is in the down position and no objects such as books, purses or briefcases are on the floor in front of the second row seats before folding them down.

Move front passenger seat forward so that the second row seat headrest clears the front seat.

For assistance, refer to the label located on the lower position of the opening.

1. Locate handle on the side of the seat cushion by the door.
2. Pull forward on the upper portion of the release handle and push the seatback toward the front of the vehicle.
3. Press down on the top outboard area of the seatback until a click is heard.

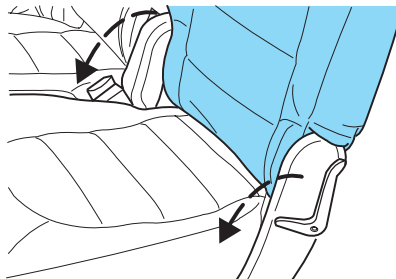

Seating and Safety Restraints

Adjusting the 2nd row recline

The 2nd row reclines for additional comfort. To adjust the 2nd row recline, pull the handle forward and push the seat back rearward.



Reclining the seatback can cause an occupant to slide under the seat's safety belt, resulting in severe personal injuries in the event of a collision.

Operating the 2nd row seat for E-Z Entry (if equipped)

The E-Z Entry seat allows for easier entry and exit to and from the 3rd row seat.

To enter the 3rd row seat:

1. Fold down the 2nd row seat.
2. Push the handle all the way forward until the seat releases from the floor.
3. Push the seat upward and fold away from the third row.

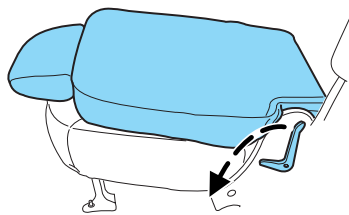

Always return the seat to the fully latched position before operating the vehicle.

To return the seat to a seating position:

1. Push the seat down and latch to the floor with a moderate amount of effort and speed.
2. Make sure the seat is latched to the floor.
3. Push the handle forward just enough so that the seat back is released.
4. Bring the seat back to an upright position. The seatback should lock into position.

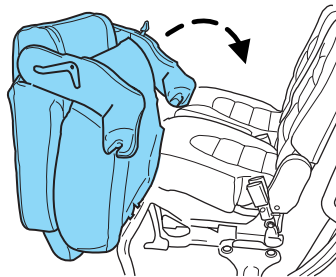



Seating and Safety Restraints

 Before returning the seatback to its original position, make sure that cargo or any objects are not trapped behind the seatback. After returning the seatback to its original position, pull on the seatback to ensure that it has fully latched. An unlatched seat may become dangerous in the event of a sudden stop or collision.

Note: If the seat back is “locked out” and cannot return to the upright position, repeat Step 2 and unlatch the seat from the floor. Repeat latching to the floor with a moderate amount of force and momentum. Your seats are equipped with an Interlock Safety Mechanism which will not allow the seats to return to a usable position if the seat is not fully latched to the floor!

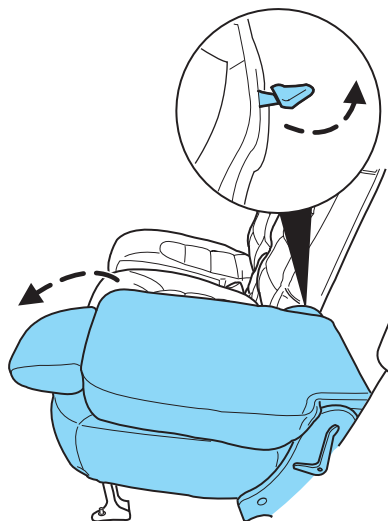
To exit the 3rd row seat, pull the red access control lever up releasing the seat from the floor and rotate the seat up towards the front seat.



 Always latch the vehicle seat to the floor, whether the seat is occupied or empty. If not latched, the seat may cause injury during a sudden stop.

Seating and Safety Restraints

Folding the middle 2nd row seat (If equipped)

To fold the seatback down:

1. Locate the lever on the top left of the seatback.
2. Pull the lever up and push the seatback toward the front of the vehicle.
3. Press down on the top outboard area of the seatback until a click is heard.

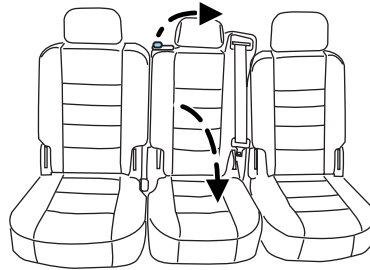

To return the seatback to the upright position:

1. Pull the lever and lift the seatback toward the rear of the vehicle.
2. Rotate the seatback until you hear a click, locking it in the upright position.

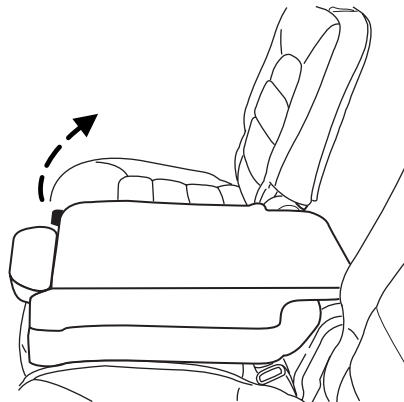

Before returning the seatback to its original position, make sure that cargo or any objects are not trapped behind the seatback. After returning the seatback to its original position, pull on the seatback to ensure that it has fully latched. An unlatched seat may become dangerous in the event of a sudden stop or collision.

Third row seat (if equipped)

3rd row stow feature

The 3rd row seat has a tip/stow feature to increase cargo space without removing the seat from the vehicle.

120

2005 Explorer (exp)
Owners Guide (post-2002-fmt)
USA (fus)

Seating and Safety Restraints

Lower the head restraints before putting the seat in the stowed position.

To put seat in stowed position:

1. Pull the seat release lever located on top of the seatback while pushing the seatback down onto the seat cushion.
2. The seatback will latch into place.

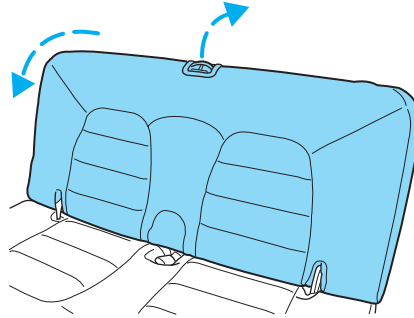

3. Push the closeout panel forward over the space between the seats.

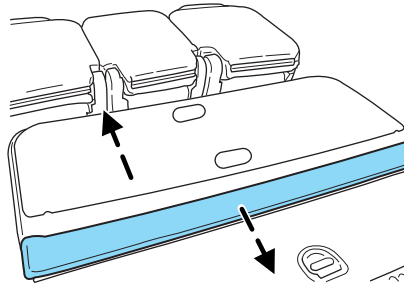

To put seat in upright position:

1. Pull back the slider panel on the seatback to release the closeout panel.

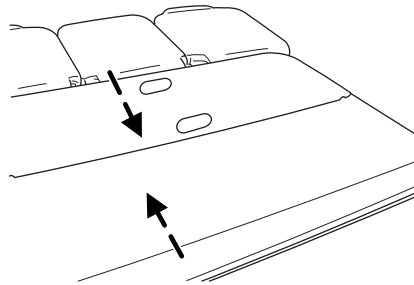

Seating and Safety Restraints

2. Pull the seat release lever located on top of the seatback while lifting the seatback into the upright position.
3. The seatback will latch into place.

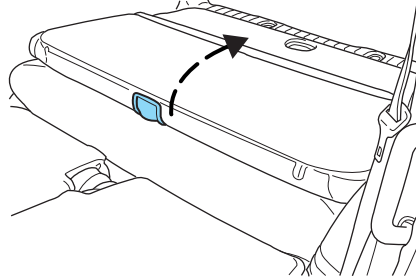

The third row seat is equipped with combination lap and shoulder belts in both seating positions. For information on the proper operation of the safety restraints, refer to *Safety restraints* in this chapter.



Before returning the seatback to its original position, make sure that cargo or any objects are not trapped behind the seatback. After returning the seatback to its original position, pull on the seatback to ensure that it has fully latched. An unlatched seat may become dangerous in the event of a sudden stop or collision.

SAFETY RESTRAINTS

Personal Safety System™

The Personal Safety System™ provides an improved overall level of frontal crash protection to front seat occupants and is designed to help further reduce the risk of airbag-related injuries. The system is able to analyze different occupant conditions and crash severity before activating the appropriate safety devices to help better protect a range of occupants in a variety of frontal crash situations.

Your vehicle's Personal Safety System™ consists of:

- Driver and passenger dual-stage airbag supplemental restraints.
- Front safety belts with pretensioners, energy management retractors, and safety belt usage sensors.
- Driver's seat position sensor.
- Front crash severity sensor.
- Restraints Control Module (RCM).
- Restraint system warning light and back-up tone.
- The electrical wiring for the airbags, crash sensor(s), safety belt pretensioners, front safety belt usage sensors, driver seat position sensor, and indicator lights.

Seating and Safety Restraints

How does the Personal Safety System™ work?

The Personal Safety System™ can adapt the deployment strategy of your vehicle's safety devices according to crash severity and occupant conditions. A collection of crash and occupant sensors provides information to the Restraints Control Module (RCM). During a crash, the RCM activates the safety belt pretensioners and/or either one or both stages of the dual-stage airbag supplemental restraints based on crash severity and occupant conditions.

The fact that the pretensioners or airbags did not activate for both front seat occupants in a collision does not mean that something is wrong with the system. Rather, it means the Personal Safety System™ determined the accident conditions (crash severity, belt usage, etc.) were not appropriate to activate these safety devices. Front airbags are designed to activate only in frontal and near-frontal collisions, not rollovers, side-impacts, or rear-impacts unless the collision causes sufficient longitudinal deceleration.

Driver and passenger dual-stage airbag supplemental restraints

The dual-stage airbags offer the capability to tailor the level of airbag inflation energy. A lower, less forceful energy level is provided for more common, moderate-severity impacts. A higher energy level is used for the most severe impacts. Refer to *Airbag supplemental restraints* section in this chapter.

Front crash severity sensor

The front crash severity sensor enhances the ability to detect the severity of an impact. Positioned up front, it provides valuable information early in the crash event on the severity of the impact. This allows your Personal Safety System™ to distinguish between different levels of crash severity and modify the deployment strategy of the dual-stage airbags and safety belt pretensioners.

Driver's seat position sensor

The driver's seat position sensor allows your Personal Safety System™ to tailor the deployment level of the driver dual-stage airbag based on seat position. The system is designed to help protect smaller drivers sitting close to the driver airbag by providing a lower airbag output level.

Front safety belt usage sensors

The front safety belt usage sensors detect whether or not the driver and front outboard passenger safety belts are fastened. This information allows your Personal Safety System™ to tailor the airbag deployment and

Seating and Safety Restraints

safety belt pretensioner activation depending upon safety belt usage. Refer to *Safety restraints* section in this chapter.

Front safety belt pretensioners

The safety belt pretensioners at the front outboard seating positions are designed to tighten the safety belts firmly against the occupant's body during frontal collisions, and in side collisions and rollovers when the vehicle is equipped with the Safety Canopy™ system. This maximizes the effectiveness of the safety belts. In frontal collisions, the safety belt pretensioners can be activated alone or, if the collision is of sufficient severity, together with the front airbags.

Front safety belt energy management retractors

The front outboard safety belt energy management retractors allow webbing to be pulled out of the retractor in a gradual and controlled manner in response to the occupant's forward momentum. This helps reduce the risk of force-related injuries to the occupant's chest by limiting the load on the occupant. Refer to *Safety restraints* section in this chapter.

Determining if the Personal Safety System™ is operational

The Personal Safety System™ uses a warning light in the instrument cluster or a back-up tone to indicate the condition of the system. Refer to the *Warning lights and chimes* section in the *Instrument Cluster* chapter. Routine maintenance of the Personal Safety System™ is not required.

The Restraints Control Module (RCM) monitors its own internal circuits and the circuits for the airbag supplemental restraints, crash sensor(s), safety belt pretensioners, front safety belt buckle sensors, and the driver seat position sensor. In addition, the RCM also monitors the restraints warning light in the instrument cluster. A difficulty with the system is indicated by one or more of the following:

- The warning light will either flash or stay lit.
- The warning light will not illuminate immediately after the ignition is turned on.
- A series of five beeps will be heard. The tone pattern will repeat periodically until the problem and warning light are repaired.

If any of these things happen, even intermittently, have the Personal Safety System™ serviced at your dealership or by a qualified technician immediately. Unless serviced, the system may not function properly in the event of a collision.

Seating and Safety Restraints

Safety restraints precautions



Always drive and ride with your seatback upright and the lap belt snug and low across the hips.



To reduce the risk of injury, make sure children sit in the back seat where they can be properly restrained.



Never let a passenger hold a child on his or her lap while the vehicle is moving. The passenger cannot protect the child from injury in a collision.



All occupants of the vehicle, including the driver, should always properly wear their safety belts, even when an airbag supplemental restraint system (SRS) is provided.



It is extremely dangerous to ride in a cargo area, inside or outside of a vehicle. In a collision, people riding in these areas are more likely to be seriously injured or killed. Do not allow people to ride in any area of your vehicle that is not equipped with seats and safety belts. Be sure everyone in your vehicle is in a seat and using a safety belt properly.



In a rollover crash, an unbelted person is significantly more likely to die than a person wearing a safety belt.



Each seating position in your vehicle has a specific safety belt assembly which is made up of one buckle and one tongue that are designed to be used as a pair. 1) Use the shoulder belt on the outside shoulder only. Never wear the shoulder belt under the arm. 2) Never swing the safety belt around your neck over the inside shoulder. 3) Never use a single belt for more than one person.



Always transport children 12 years old and under in the back seat and always properly use appropriate child restraints.

Seating and Safety Restraints

 Safety belts and seats can become hot in a vehicle that has been closed up in sunny weather; they could burn a small child. Check seat covers and buckles before you place a child anywhere near them.

Energy Management Feature

- This vehicle has a safety belt system with an energy management feature at the front seating positions to help further reduce the risk of injury in the event of a head-on collision.
- This safety belt system has a retractor assembly that is designed to extend the safety belt webbing in a controlled manner. This helps reduce the belt force acting on the user's chest.

 BELT AND RETRACTOR ASSEMBLY MUST BE REPLACED if the safety belt assembly automatic locking retractor feature or any other safety belt function is not operating properly when checked according to the procedures in *Workshop Manual*. Failure to replace the Belt and Retractor assembly could increase the risk of injury in collisions.

Combination lap and shoulder belts

1. Insert the belt tongue into the proper buckle (the buckle closest to the direction the tongue is coming from) until you hear a snap and feel it latch. Make sure the tongue is securely fastened in the buckle.

- Front and rear seats

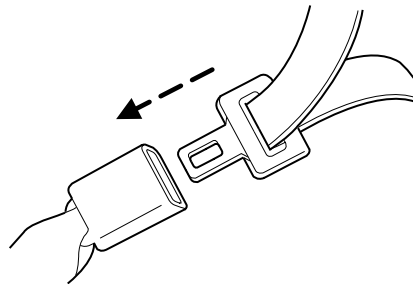

2. To unfasten, push the release button and remove the tongue from the buckle.

Seating and Safety Restraints

- Front and rear seats

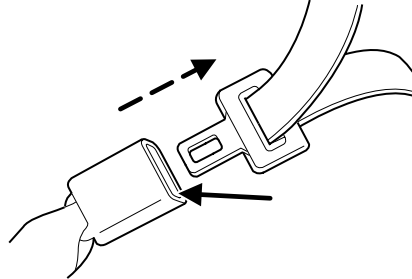

All safety restraints in the vehicle are combination lap and shoulder belts. All of the passenger combination lap and shoulder belts have two types of locking modes described below:

Vehicle sensitive mode

This is the normal retractor mode, which allows free shoulder belt length adjustment to your movements and locking in response to vehicle movement. For example, if the driver brakes suddenly or turns a corner sharply, or the vehicle receives an impact of approximately 5 mph (8 km/h) or more, the combination safety belts will lock to help reduce forward movement of the driver and passengers.

Automatic locking mode

When to use the automatic locking mode

In this mode, the shoulder belt is automatically pre-locked. The belt will still retract to remove any slack in the shoulder belt. The automatic locking mode is not available on the driver safety belt.

This mode should be used **any time** a child safety seat is installed in a passenger front or outboard rear seating position (if equipped). Children 12 years old and under should be properly restrained in the rear seat whenever possible. Refer to *Safety restraints for children* or *Safety seats for children* later in this chapter.

Seating and Safety Restraints

How to use the automatic locking mode

- Buckle the combination lap and shoulder belt.

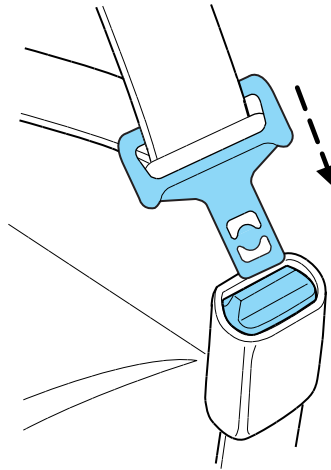

- Grasp the shoulder portion and pull downward until the entire belt is pulled out.





- Allow the belt to retract. As the belt retracts, you will hear a clicking sound. This indicates the safety belt is now in the automatic locking mode.

How to disengage the automatic locking mode

Unbuckle the combination lap and shoulder belt and allow it to retract completely to disengage the automatic locking mode and activate the vehicle sensitive (emergency) locking mode.

Seating and Safety Restraints

 After any vehicle collision, the combination lap and shoulder belt system at all passenger seating positions must be checked by a qualified technician to verify that the “automatic locking retractor” feature for child seats is still functioning properly, in addition to other checks for proper safety belt system function.

 **BELT AND RETRACTOR ASSEMBLY MUST BE REPLACED** if the safety belt assembly “automatic locking retractor” feature or any other safety belt function is not operating properly. In addition, all safety belts should be checked for proper function. Failure to replace the belt and retractor assembly could increase the risk of injury in collisions.

Safety belt pretensioner

Your vehicle is equipped with safety belt pretensioners at the driver and right front passenger seating positions.

The safety belt pretensioner removes some slack from the safety belt system at the start of a crash. The safety belt pretensioner uses the same crash sensor system as the front airbags and Safety Canopy™ system (if equipped). When the safety belt pretensioner deploys, the lap and shoulder belt are tightened.

When the optional Safety Canopy™ system and/or the front airbags are activated, the safety belt pretensioners for the driver and right front passenger seating positions will be activated when the respective seatbelt is properly buckled.

 The driver and the right front passenger safety belt system (including retractors, buckles and height adjusters) must be replaced if the vehicle is involved in a collision that results in deployment of front airbags or Safety Canopy™ and safety belt pretensioners.

Refer to the *Safety belt maintenance* section in this chapter.

Seating and Safety Restraints

Safety belt height adjustment

Your vehicle has safety belt height adjustments for the front and second row outboard seating positions.

Adjust the height of the shoulder belt so the belt rests across the middle of your shoulder.

To adjust the shoulder belt height, squeeze the button and slide the height adjuster up or down. Release the button and pull down on the height adjuster to make sure it is locked in place.

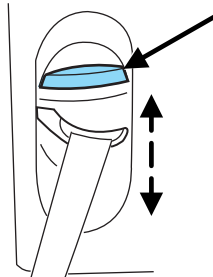

Position the safety belt height adjusters so that the belt rests across the middle of your shoulder. Failure to adjust the safety belt properly could reduce the effectiveness of the safety belt and increase the risk of injury in a collision.

Safety belt extension assembly

If the safety belt is too short when fully extended, there is a 8 inch (20 cm) safety belt extension assembly that can be added (part number 611C22). This assembly can be obtained from your dealer at no cost.

Use only extensions manufactured by the same supplier as the safety belt. Manufacturer identification is located at the end of the webbing on the label. Also, use the safety belt extension only if the safety belt is too short for you when fully extended.



Do not use extensions to change the fit of the shoulder belt across the torso.

Safety belt warning light and indicator chime

The safety belt warning light illuminates in the instrument cluster and a chime sounds to remind the occupants to fasten their safety belts.

Seating and Safety Restraints

Conditions of operation

If...	Then...
The driver's safety belt is not buckled before the ignition switch is turned to the ON position...	The safety belt warning light illuminates 1-2 minutes and the warning chime sounds 4-8 seconds.
The driver's safety belt is buckled while the indicator light is illuminated and the warning chime is sounding...	The safety belt warning light and warning chime turn off.
The driver's safety belt is buckled before the ignition switch is turned to the ON position...	The safety belt warning light and indicator chime remain off.

BeltMinder™

The BeltMinder™ feature is a supplemental warning to the safety belt warning function. This feature provides additional reminders to the driver that the driver's safety belt is unbuckled by intermittently sounding a chime and illuminating the safety belt warning lamp in the instrument cluster.

If...	Then...
The driver's safety belt is not buckled before the vehicle has reached at least 3 mph (5 km/h) and 1-2 minutes have elapsed since the ignition switch has been turned to ON...	The BeltMinder™ feature is activated - the safety belt warning light illuminates and the warning chime sounds for 6 seconds every 30 seconds, repeating for approximately 5 minutes or until safety belt is buckled.
The driver's safety belt is buckled while the safety belt indicator light is illuminated and the safety belt warning chime is sounding...	The BeltMinder™ feature will not activate.
The driver's safety belt is buckled before the ignition switch is turned to the ON position...	The BeltMinder™ feature will not activate.

Seating and Safety Restraints

The following are reasons most often given for not wearing safety belts (All statistics based on U.S. data):

Reasons given...	Consider...
"Crashes are rare events"	36700 crashes occur every day. The more we drive, the more we are exposed to "rare" events, even for good drivers. <i>1 in 4 of us will be seriously injured in a crash during our lifetime.</i>
"I'm not going far"	3 of 4 fatal crashes occur within 25 miles (40 km) of home.
"Belts are uncomfortable"	We design our safety belts to enhance comfort. If you are uncomfortable - try different positions for the safety belt upper anchorage and seatback which should be as upright as possible; this can improve comfort.
"I was in a hurry"	Prime time for an accident. BeltMinder [™] reminds us to take a few seconds to buckle up.
"Safety belts don't work"	Safety belts , when used properly, reduce risk of death to front seat occupants by 45% in cars , and by 60% in light trucks .
"Traffic is light"	Nearly 1 of 2 deaths occur in single-vehicle crashes , many when no other vehicles are around.
"Belts wrinkle my clothes"	Possibly, but a serious crash can do much more than wrinkle your clothes, particularly if you are unbelted.
"The people I'm with don't wear belts"	Set the example, teen deaths occur 4 times more often in vehicles with TWO or MORE people. Children and younger brothers/sisters imitate behavior they see.
"I have an airbag"	Airbags offer greater protection when used with safety belts. Frontal airbags are not designed to inflate in rear and side crashes or rollovers.
"I'd rather be thrown clear"	Not a good idea. People who are ejected are 40 times more likely to DIE . Safety belts help prevent ejection, WE CAN'T "PICK OUR CRASH".

Seating and Safety Restraints



Do not sit on top of a buckled safety belt to avoid the BeltMinder™ chime. Sitting on the safety belt will increase the risk of injury in an accident. To disable (one-time) or deactivate the BeltMinder™ feature please follow the directions stated below.

One time disable

Any time the safety belt is buckled and then unbuckled during an ignition ON cycle, the BeltMinder™ will be disabled for that ignition cycle only.

Deactivating/activating the BeltMinder™ feature

Before following the procedure, make sure that:

- the parking brake is set
- the gearshift is in P (Park)
- the ignition switch is in the OFF position
- all vehicle doors are closed
- the driver's safety belt is unbuckled
- the parklamps/headlamps are in OFF position (If vehicle is equipped with Autolamps, the Autolamps feature **MUST** be turned off.)

Read Steps 1 - 9 thoroughly before proceeding with the deactivation/activation programming procedure.

BeltMinder™ deactivation/activation procedure



To reduce the risk of injury, do not deactivate/activate the Belt Minder feature while driving the vehicle.

1. Turn the ignition switch to the RUN (or ON) position. (DO NOT START THE ENGINE)
2. Wait until the safety belt warning light turns off. (Approximately 1–2 minutes)
 - Steps 3–5 must be completed within 60 seconds or the procedure will have to be repeated.
3. At a moderate speed, buckle then unbuckle the safety belt three times, ending with the safety belt unbuckled. This can be done before or during BeltMinder™ warning activation.
4. Turn on the parklamps/headlamps, turn off the parklamps/headlamps.
5. At a moderate speed, buckle then unbuckle the safety belt three times, ending with the safety belt unbuckled.

Seating and Safety Restraints

- After Step 5 the safety belt warning light will be turned on for three seconds.
6. Within seven seconds of the safety belt warning light turning off, at a moderate speed, buckle then unbuckle the safety belt.
 - This will disable BeltMinder™ if it is currently enabled, or enable BeltMinder™ if it is currently disabled.
 7. Confirmation of disabling BeltMinder™ is provided by flashing the safety belt warning light four times per second for three seconds.
 8. Confirmation of enabling BeltMinder™ is provided by flashing the safety belt warning light four times per second for three seconds, followed by three seconds with the safety belt warning light off, then followed by flashing the safety belt warning light four times per second for three seconds again.
 9. After receiving confirmation, the deactivation/activation procedure is complete.

Safety belt maintenance

Inspect the safety belt systems periodically to make sure they work properly and are not damaged. Inspect the safety belts to make sure there are no nicks, tears or cuts. Replace if necessary. All safety belt assemblies, including retractors, buckles, front safety belt buckle assemblies, buckle support assemblies (slide bar-if equipped), shoulder belt height adjusters (if equipped), shoulder belt guide on seatback (if equipped), child safety seat LATCH and tether anchors, and attaching hardware, should be inspected after a collision. Ford Motor Company recommends that all safety belt assemblies in use in vehicles involved in a collision be replaced. However, if the collision was minor and a qualified technician finds that the belts do not show damage and continue to operate properly, they do not need to be replaced. Safety belt assemblies not in use during a collision should also be inspected and replaced if either damage or improper operation is noted.



Failure to inspect and if necessary replace the safety belt assembly under the above conditions could result in severe personal injuries in the event of a collision.

For proper care of soiled safety belts, refer to *Interior* in the *Cleaning* chapter.

Seating and Safety Restraints

AIRBAG SUPPLEMENTAL RESTRAINT SYSTEM (SRS)

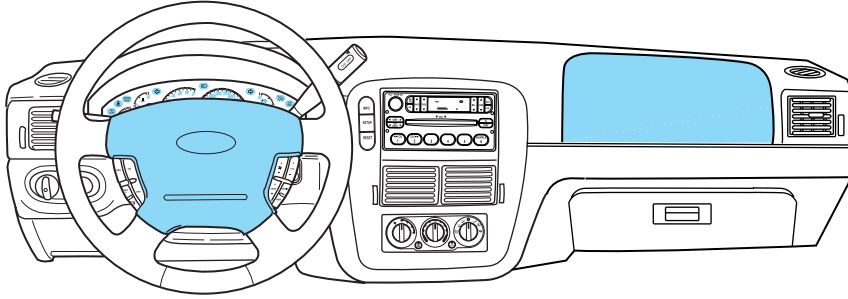

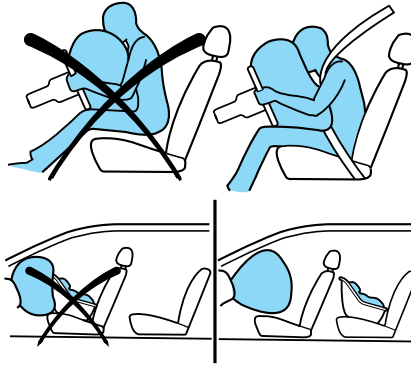

Important SRS precautions

The SRS is designed to work with the safety belt to help protect the driver and right front passenger from certain upper body injuries. Airbags DO NOT inflate slowly; there is a risk of injury from a deploying airbag.



 All occupants of the vehicle, including the driver, should always properly wear their safety belts, even when an air bag supplemental restraint system (SRS) is provided.

 Always transport children 12 years old and under in the back seat and always properly use appropriate child restraints.

 The National Highway Traffic Safety Administration (NHTSA) recommends a minimum distance of at least 10 inches (25 cm) between an occupant's chest and the driver airbag module.

Seating and Safety Restraints



Never place your arm over the air bag module as a deploying air bag can result in serious arm fractures or other injuries.

To properly position yourself away from the airbag:

- Move your seat to the rear as far as you can while still reaching the pedals comfortably.
- Recline the seat slightly one or two degrees from the upright position.



Do not put anything on or over the air bag module. Placing objects on or over the air bag inflation area may cause those objects to be propelled by the air bag into your face and torso causing serious injury.



Do not attempt to service, repair, or modify the airbag supplemental restraint systems or its fuses. See your Ford or Lincoln Mercury dealer.



Modifications to the front end of the vehicle, including frame, bumper, front end body structure and non-Ford tow hooks may effect the performance of the airbag sensors increasing the risk of injury. Do not modify the front end of the vehicle with anything other than authorized Ford accessories for your vehicle.



Additional equipment may affect the performance of the airbag sensors increasing the risk of injury. Please refer to the *Body Builders Layout Book* for instructions about the appropriate installation of additional equipment.

Seating and Safety Restraints

Children and airbags

Children must always be properly restrained. Accident statistics suggest that children are safer when properly restrained in the rear seating positions than in the front seating position. Failure to follow these instructions may increase the risk of injury in a collision.

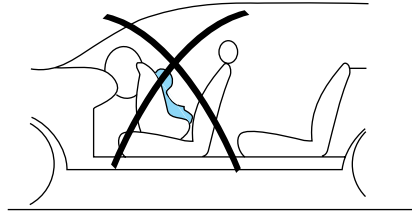

Airbags can kill or injure a child in a child seat.

NEVER place a rear-facing child seat in front of an active airbag. If you must use a forward-facing child seat in the front seat, move the seat all the way back.

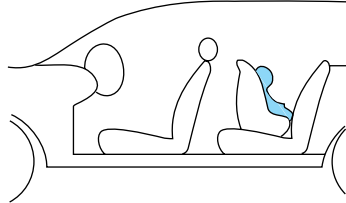

How does the airbag supplemental restraint system work?

The airbag SRS is designed to activate when the vehicle sustains longitudinal deceleration sufficient to cause the sensors to close an electrical circuit that initiates airbag inflation.

The fact that the airbags did not inflate in a collision does not mean that something is wrong with the system. Rather, it means the forces were not of the type sufficient to cause activation. Front airbags are designed to inflate in frontal and near-frontal collisions, not rollover, side-impact, or rear-impacts unless the collision causes sufficient longitudinal deceleration.

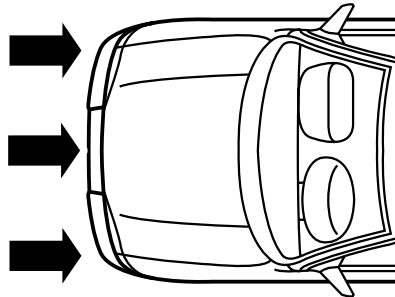

Seating and Safety Restraints

The airbags inflate and deflate rapidly upon activation. After airbag deployment, it is normal to notice a smoke-like, powdery residue or smell the burnt propellant. This may consist of cornstarch, talcum powder (to lubricate the bag) or sodium compounds (e.g., baking soda) that result from the combustion process that inflates the airbag. Small amounts of sodium hydroxide may be present which may irritate the skin and eyes, but none of the residue is toxic.



While the system is designed to help reduce serious injuries, contact with a deploying airbag may also cause abrasions, swelling or temporary hearing loss. Because airbags must inflate rapidly and with considerable force, there is the risk of death or serious injuries such as fractures, facial and eye injuries or internal injuries, particularly to occupants who are not properly restrained or are otherwise out of position at the time of airbag deployment. Thus, it is extremely important that occupants be properly restrained as far away from the airbag module as possible while maintaining vehicle control.



Several air bag system components get hot after inflation. Do not touch them after inflation.



If the air bag has deployed, **the air bag will not function again and must be replaced immediately.** If the air bag is not replaced, the unrepaired area will increase the risk of injury in a collision.

The SRS consists of:

- driver and passenger airbag modules (which include the inflators and airbags).
- Safety Canopy™ system (if equipped). Refer to *Safety Canopy™ system* later in this chapter.
- one or more impact and safing sensors.
- a readiness light and tone.

138

2005 Explorer (exp)
Owners Guide (post-2002-fmt)
USA (fus)

Seating and Safety Restraints

- diagnostic module.
- and the electrical wiring which connects the components.

The diagnostic module monitors its own internal circuits and the supplemental airbag electrical system wiring (including the impact sensors), the system wiring, the airbag system readiness light, the airbag back up power and the airbag ignitors.

Determining if the system is operational

The SRS uses a readiness light in the instrument cluster or a tone to indicate the condition of the system. Refer to *Airbag readiness* section in the *Instrument Cluster* chapter. Routine maintenance of the airbag is not required.

A difficulty with the system is indicated by one or more of the following:

- The readiness light will either flash or stay lit.
- The readiness light will not illuminate immediately after ignition is turned on.
- A series of five beeps will be heard. The tone pattern will repeat periodically until the problem and/or light are repaired.



If any of these things happen, even intermittently, have the SRS serviced at your dealership or by a qualified technician immediately. Unless serviced, the system may not function properly in the event of a collision.

Safety Canopy™ system (if equipped)



Do not place objects or mount equipment on or near the headliner at the siderail that may come into contact with a deploying Safety Canopy™. Failure to follow these instructions may increase the risk of personal injury in the event of a collision.

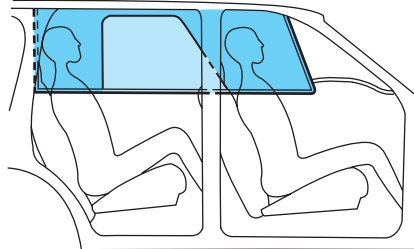

Seating and Safety Restraints



Do not lean your head on the door. The Safety Canopy™ could injure you as it deploys from the headliner.



Do not attempt to service, repair, or modify the Safety Canopy™ system, its fuses, the A, B, or C pillar trim, or the headliner on a vehicle containing a Safety Canopy™. See your Ford or Lincoln Mercury dealer.



All occupants of the vehicle including the driver should always wear their safety belts even when an airbag SRS and Safety Canopy™ system is provided.



To reduce risk of injury, do not obstruct or place objects in the deployment path of the inflatable Safety Canopy™.

Seating and Safety Restraints

How does the Safety Canopy™ system work?

The design and development of the Safety Canopy™ system included recommended testing procedures that were developed by a group of automotive safety experts known as the Side Airbag Technical Working Group. These recommended testing procedures help reduce the risk of injuries related to the deployment of side airbags (including the Safety Canopy™).

The Safety Canopy™ system consists of the following:

- An inflatable nylon curtain with a gas generator concealed behind the headliner and above the doors (one on each side of the vehicle).
- A headliner that will flex to open above the side doors to allow Safety Canopy™ deployment.
- The same warning light, electronic control and diagnostic unit as used for the front airbags.
- Two side crash sensors mounted at the base of the B-pillar (one on each side of the vehicle).
- Two side crash sensors located at the c-pillar behind the rear doors (one on each side of the vehicle).
- Roll over sensor in the restraints control module (RCM).

The Safety Canopy™ system, in combination with safety belts, can help reduce the risk of severe injuries in the event of a significant side impact collision or rollover event.

Children 12 years old and under should always be properly restrained in the second or third row seats (if equipped). The Safety Canopy™ will not interfere with children restrained using a properly installed child or booster seat because it is designed to inflate downward from the headliner above the doors along the side window openings.

The Safety Canopy™ system is designed to activate when the vehicle sustains lateral deceleration sufficient to cause the side crash sensor to close an electrical circuit that initiates Safety Canopy™ inflation or when a certain likelihood of a rollover event is detected by the rollover sensor.

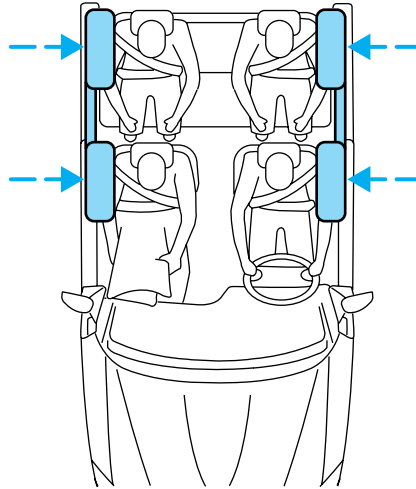

Seating and Safety Restraints

The Safety Canopy™ is mounted to the roof side-rail sheet metal, behind the headliner, above the first and second row seats. In certain lateral collisions or rollover events, the Safety Canopy™ system will be activated, regardless of which seats are occupied. The Safety Canopy™ is designed to inflate between the side window area and occupants to further enhance protection provided in side impact collisions and rollover events.

The fact that the Safety Canopy™ system did not activate in a collision does not mean that something is wrong with the system. Rather, it means the forces were not of the type sufficient to cause activation. The Safety Canopy™ is designed to inflate in certain side impact collisions or rollover events, not in rear impact, frontal or near-frontal collisions, unless the collision causes sufficient lateral deceleration or rollover likelihood.



Several Safety Canopy™ system components get hot after inflation. Do not touch them after inflation.



If the Safety Canopy™ system has deployed, **the Safety Canopy™ will not function again. The Safety Canopy™ system (including the A, B and C pillar trim) must be inspected and serviced by a qualified technician in accordance with the vehicle service manual.** If the Safety Canopy™ is not replaced, the unrepaired area will increase the risk of injury in a collision.

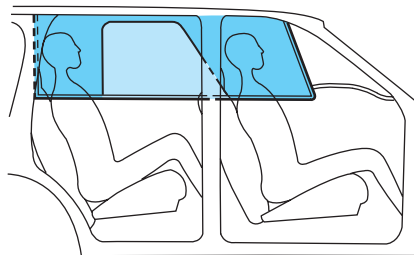

Determining if the system is operational

The SRS uses a readiness light in the instrument cluster or a tone to indicate the condition of the system. Refer to the *Airbag readiness* section in the *Instrument Cluster* chapter. Routine maintenance of the airbag is not required.

Any difficulty with the system is indicated by one or more of the following:

142

2005 Explorer (exp)
Owners Guide (post-2002-fmt)
USA (fus)

Seating and Safety Restraints

- The readiness light (same light as for front airbag system) will either flash or stay lit.
- The readiness light will not illuminate immediately after ignition is turned on.
- A series of five beeps will be heard. The tone pattern will repeat periodically until the problem and light are repaired.

If any of these things happen, even intermittently, have the SRS serviced at your dealership or by a qualified technician immediately. Unless serviced, the system may not function properly in the event of a collision or rollover event.

Disposal of airbags and airbag equipped vehicles (including pretensioners)

See your local dealership or qualified technician. Airbags MUST BE disposed of by qualified personnel.

SAFETY RESTRAINTS FOR CHILDREN

See the following sections for directions on how to properly use safety restraints for children. Also see *Airbag supplemental restraint system (SRS)* in this chapter for special instructions about using airbags.

Important child restraint precautions

You are required by law to use safety restraints for children in the U.S. and Canada. If small children (generally children who are four years old or younger and who weigh 40 lb. [18 kg] or less) ride in your vehicle, you must put them in safety seats made especially for children. Many states require that children use approved booster seats until they are eight years old. Check your local and state or provincial laws for specific requirements regarding the safety of children in your vehicle. When possible, always place children under age 12 in the rear seat of your vehicle. Accident statistics suggest that children are safer when properly restrained in the rear seating positions than in the front seating position.



Never let a passenger hold a child on his or her lap while the vehicle is moving. The passenger cannot protect the child from injury in a collision.

Always follow the instructions and warnings that come with any infant or child restraint you might use.

Seating and Safety Restraints

Children and safety belts

If the child is the proper size, restrain the child in a safety seat. Children who are too large for child safety seats (as specified by your child safety seat manufacturer) should always wear safety belts.

Follow all the important safety restraint and airbag precautions that apply to adult passengers in your vehicle.

If the shoulder belt portion of a combination lap and shoulder belt can be positioned so it does not cross or rest in front of the child's face or neck, the child should wear the lap and shoulder belt. Moving the child closer to the center of the vehicle may help provide a good shoulder belt fit.



Do not leave children, unreliable adults, or pets unattended in your vehicle.

Child booster seats

Children outgrow a typical convertible or toddler seat when they weigh 40 lb. (18 kg) and are around 4 years of age. Although the lap/shoulder belt will provide some protection, these children are still too small for lap/shoulder belts to fit properly, which could increase the risk of serious injury.

To improve the fit of both the lap and shoulder belt on children who have outgrown child safety seats, Ford Motor Company recommends use of a belt-positioning booster.

Booster seats position a child so that safety belts fit better. They lift the child up so that the lap belt rests low across the hips and the knees bend comfortably. Booster seats also make the shoulder belt fit better and more comfortably for growing children.

When children should use booster seats

Children need to use booster seats from the time they outgrow the toddler seat until they are big enough for the vehicle seat and lap/shoulder belt to fit properly. Generally this is when they weigh about 80 lb. (36 kg) (about 8 to 12 years old).

Booster seats should be used until you can answer YES to ALL of these questions:

Seating and Safety Restraints

- Can the child sit all the way back against the vehicle seat back with knees bent comfortably at the edge of the seat without slouching?

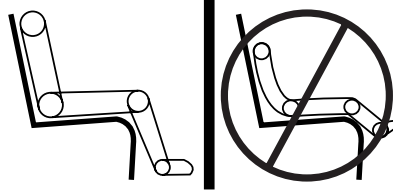

- Does the lap belt rest low across the hips?
- Is the shoulder belt centered on the shoulder and chest?
- Can the child stay seated like this for the whole trip?

Types of booster seats

There are two types of belt-positioning booster seats:

- Those that are backless.

If your backless booster seat has a removable shield, remove the shield and use the lap/shoulder belt. If a seating position has a low seat back and no head restraint, a backless booster seat may place your child's head (top of ear level) above the top of the seat. In this case, move the backless booster to another seating position with a higher seat back and lap/shoulder belts.



- Those with a high back.

If, with a backless booster seat, you cannot find a seating position that adequately supports your child's head, a high back booster seat would be a better choice.



Both can be used in any vehicle in a seating position equipped with lap/shoulder belts if your child is over 40 lb. (18 kg).

Seating and Safety Restraints

The shoulder belt should cross the chest, resting snugly on the center of the shoulder. The lap belt should rest low and snug across the hips, never up high across the stomach.

If the booster seat slides on the vehicle seat, placing a rubberized mesh sold as shelf or carpet liner under the booster seat may improve this condition.

The importance of shoulder belts

Using a booster without a shoulder belt increases the risk of a child's head hitting a hard surface in a collision. For this reason, you should never use a booster seat with a lap belt only. It is best to use a booster seat with lap/shoulder belts in the back seat- the safest place for children to ride.



Follow all instructions provided by the manufacturer of the booster seat.



Never put the shoulder belt under a child's arm or behind the back because it eliminates the protection for the upper part of the body and may increase the risk of injury or death in a collision.



Never use pillows, books, or towels to boost a child. They can slide around and increase the likelihood of injury or death in a collision.

SAFETY SEATS FOR CHILDREN

Child and infant or child safety seats

Use a safety seat that is recommended for the size and weight of the child. Carefully follow all of the manufacturer's instructions with the safety seat you put in your vehicle. If you do not install and use the safety seat properly, the child may be injured in a sudden stop or collision.

When installing a child safety seat:

Seating and Safety Restraints

- Review and follow the information presented in the *airbag supplemental restraint system* (SRS) section in this chapter.
- Use the correct safety belt buckle for that seating position (the buckle closest to the direction the tongue is coming from).
- Insert the belt tongue into the proper buckle until you hear a snap and feel it latch. Make sure the tongue is securely fastened in the buckle.
- Keep the buckle release button pointing up and away from the safety seat, with the tongue between the child seat and the release button, to prevent accidental unbuckling.
- Place seat back in upright position.
- Put the safety belt in the automatic locking mode. Refer to *Automatic locking mode* (passenger side front and outboard rear seating positions) (if equipped) section in this chapter.
- LATCH lower anchors are recommended for use by children up to 48 lb. (22 kg) in a child restraint. Top tether anchors can be used for children up to 60 pounds (27 kg) in a child restraint, and to provide upper torso restraint for children up to 80 lb. (36 kg) using an upper torso harness and a belt-positioning booster.

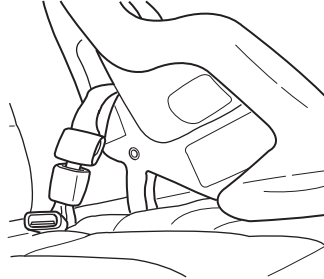

Ford recommends the use of a child safety seat having a top tether strap. Install the child safety seat in a seating position with LATCH and tether anchors. For more information on top tether straps and anchors, refer to *Attaching safety seats with tether straps* in this chapter. For more information of LATCH anchors refer to *Attaching safety seats with LATCH (Lower Anchors and Tethers for Children) attachments* in this chapter.

 Carefully follow all of the manufacturer's instructions included with the safety seat you put in your vehicle. If you do not install and use the safety seat properly, the child may be injured in a sudden stop or collision.

 Rear-facing child seats or infant carriers should never be placed in the front seats.

Seating and Safety Restraints

Installing child safety seats with combination lap and shoulder belts

 Airbags can kill or injure a child in a child seat. **NEVER** place a rear-facing child seat in front of an active airbag. If you must use a forward-facing child seat in the front seat, move the seat all the way back.

 Children 12 and under should be properly restrained in the rear seat whenever possible.

1. Position the child safety seat in a seat with a combination lap and shoulder belt.

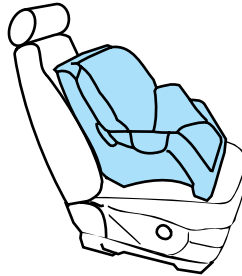

2. Pull down on the shoulder belt and then grasp the shoulder belt and lap belt together.

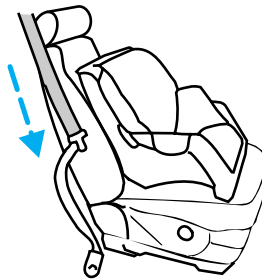

Seating and Safety Restraints

3. While holding the shoulder and lap belt portions together, route the tongue through the child seat according to the child seat manufacturer's instructions. Be sure the belt webbing is not twisted.

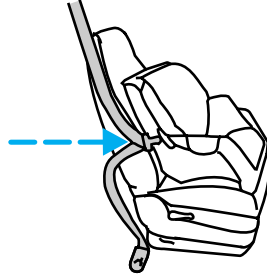

4. Insert the belt tongue into the proper buckle (the buckle closest to the direction the tongue is coming from) for that seating position until you hear a snap and feel the latch engage. Make sure the tongue is latched securely by pulling on it.

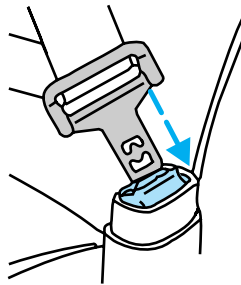

5. To put the retractor in the automatic locking mode, grasp the shoulder portion of the belt and pull downward until all of the belt is pulled out and a click is heard.

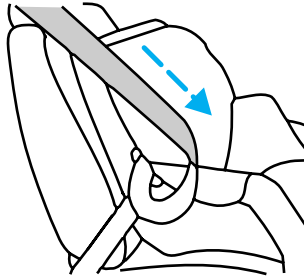

6. Allow the belt to retract. The belt will click as it retracts to indicate it is in the automatic locking mode.

Seating and Safety Restraints

7. Pull the lap belt portion across the child seat toward the buckle and pull up on the shoulder belt while pushing down with your knee on the child seat.

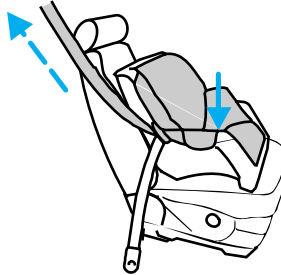

8. Allow the safety belt to retract to remove any slack in the belt.

9. Before placing the child in the seat, forcibly move the seat forward and back to make sure the seat is securely held in place. To check this, grab the seat at the belt path and attempt to move it side to side and forward. There should be no more than one inch of movement for proper installation.

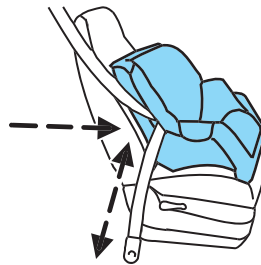

10. Try to pull the belt out of the retractor to make sure the retractor is in the automatic locking mode (you should not be able to pull more belt out). If the retractor is not locked, unbuckle the belt and repeat Steps 2 through 9.

Check to make sure the child seat is properly secured before each use.

Attaching child safety seats with tether straps

Most new forward-facing child safety seats include a tether strap which goes over the back of the seat and hooks to an anchoring point. Tether straps are available as an accessory for many older safety seats. Contact the manufacturer of your child seat for information about ordering a tether strap.

Seating and Safety Restraints

The rear seats of your vehicle are equipped with built-in tether strap anchors located behind the seats as shown below.

The tether strap anchors in your vehicle are in the following positions (shown from top view):

- 5 passenger vehicle

For the center seat, use either of the two tether anchors/cargo tie-downs in the scuff plate along the back edge of the floor.

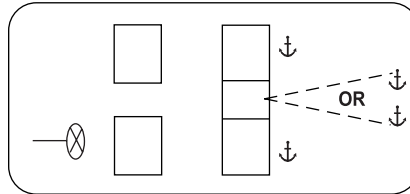

- 7 passenger vehicle

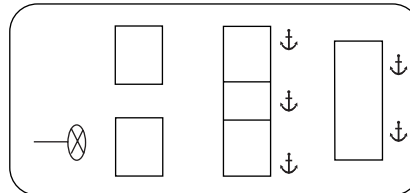

Attach the tether strap only to the appropriate tether anchor as shown. The tether strap may not work properly if attached somewhere other than the correct tether anchor.

1. Position the child safety seat on the rear seat cushion.
2. Route the tether strap under the head restraint and between the head restraint posts.
3. Locate the correct anchor for the selected rear seating position.

When placing a child safety seat in the 2nd row center seating position of the 5 passenger vehicle, the tether straps may be attached to either of the tether anchors located at the rear of the cargo area.

Seating and Safety Restraints

- Behind 2nd row seat

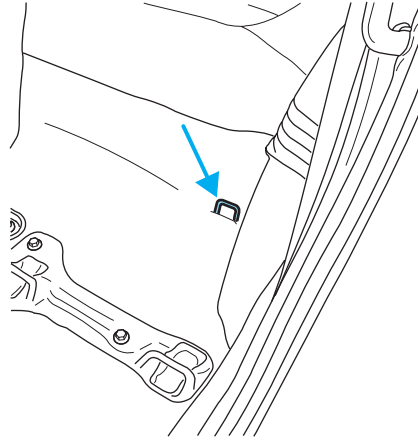

- At the rear of the cargo area

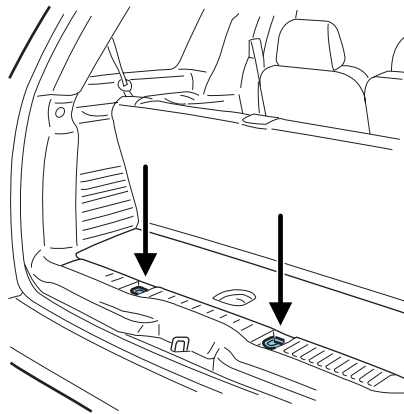

Seating and Safety Restraints

4. Clip the tether strap to the anchor.

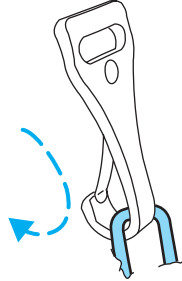

If the tether strap is clipped incorrectly, the child safety seat may not be retained properly in the event of a collision.

5. Install the child safety seat tightly using the LATCH anchors or safety belts. Follow the instructions in this chapter.

6. Tighten the child safety seat tether strap according to the manufacturer's instructions.



If the safety seat is not anchored properly, the risk of a child being injured in a collision greatly increases.

Attaching safety seats with LATCH (Lower Anchors and Tethers for Children) attachments for child seat anchors

Some child safety seats have two rigid or webbing mounted attachments that connect to two anchors at certain seating positions in your vehicle. This type of child seat eliminates the need to use seat belts to attach the child seat. For forward-facing child seats, the tether strap must also be attached to the proper tether anchor. See *Attaching child safety seats with tether straps* in this chapter.

Seating and Safety Restraints

Your vehicle has LATCH anchors for child seat installation at the seating positions marked with the child seat symbol:

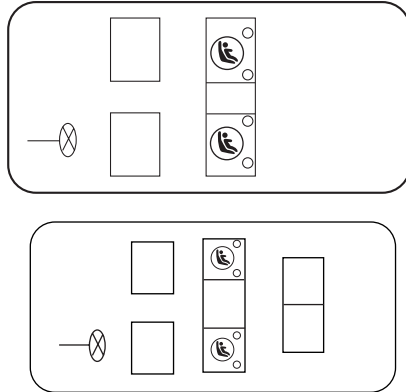

! Never attach two LATCH child safety seats to the same anchor. In a crash, one anchor may not be strong enough to hold two child safety seat attachments and may break, causing serious injury or death.

The lower anchors for child seat installation are located at the rear section of the second row seat between the cushion and seat back. The LATCH anchors are below the locator symbols on the seat back.

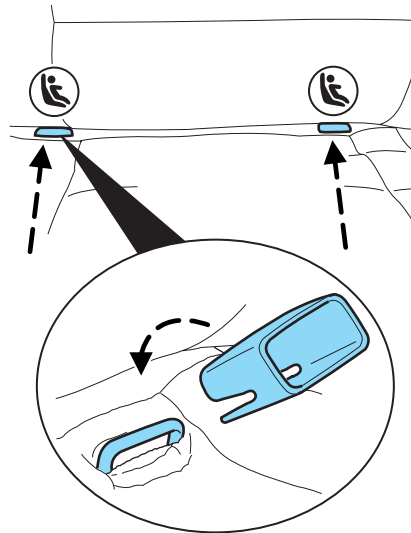

Seating and Safety Restraints

Follow the child seat manufacturer's instructions to properly install a child seat with LATCH attachments. Two plastic LATCH guides can be obtained at no charge from any Ford or Lincoln/Mercury dealer. They snap onto the LATCH lower anchors in the seat to help attach a child seat with rigid attachments. The guides hold the seat trim away to expose the anchor and make it easier to attach some child seats.



Attach LATCH lower attachments of the child seat only to the anchors shown.

If you install a child seat with rigid LATCH attachments, do not tighten the tether strap enough to lift the child seat off the vehicle seat cushion when the child is seated in it. Keep the tether strap just snug without lifting the front of the child seat. Keeping the child seat just touching the vehicle seat gives the best protection in a severe crash.

Each time you use the safety seat, check that the seat is properly attached to the lower anchors and tether anchor. Try to move the child seat from side to side. Also try to tug the seat forward. Check to see if the anchors hold the seat in place.





If the safety seat is not anchored properly, the risk of a child being injured in a crash greatly increases.

Tires, Wheels and Loading

NOTICE TO UTILITY VEHICLE AND TRUCK OWNERS

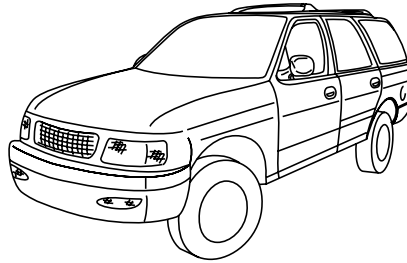
Utility vehicles and trucks handle differently than passenger cars in the various driving conditions that are encountered on streets, highways and off-road. Utility vehicles and trucks are not designed for cornering at speeds as high as passenger cars any more than low-slung sports cars are designed to perform satisfactorily under off-road conditions.



 Utility vehicles have a significantly higher rollover rate than other types of vehicles. To reduce the risk of serious injury or death from a rollover or other crash you must:

- Avoid sharp turns and abrupt maneuvers;
- Drive at safe speeds for the conditions;
- Keep tires properly inflated;
- Never overload or improperly load your vehicle; and
- Make sure every passenger is properly restrained.

 In a rollover crash, an unbelted person is significantly more likely to die than a person wearing a seat belt. All occupants must wear safety belts and children/infants must use appropriate restraints to minimize the risk of injury or ejection.

Study your *Owner's Guide* and any supplements for specific information about equipment features, instructions for safe driving and additional precautions to reduce the risk of an accident or serious injury.

VEHICLE CHARACTERISTICS

4WD and AWD Systems (if equipped)

A vehicle equipped with AWD or 4WD (when selected) has the ability to use all four wheels to power itself. This increases traction which may enable you to safely drive over terrain and road conditions that a conventional two-wheel drive vehicle cannot.

156

2005 Explorer (exp)
Owners Guide (post-2002-fmt)
USA (fus)

Tires, Wheels and Loading

Power is supplied to all four wheels through a transfer case or power transfer unit. 4WD vehicles allow you to select different drive modes as necessary. Information on transfer case operation and shifting procedures can be found in the *Driving* chapter. Information on transfer case maintenance can be found in the *Maintenance and Specification* chapter. You should become thoroughly familiar with this information before you operate your vehicle.

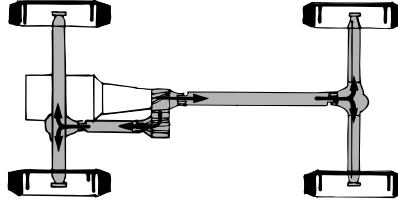

On some 4WD models, the initial shift from two-wheel drive to 4WD while the vehicle is moving can cause a momentary clunk and ratcheting sound. These sounds are normal as the front drivetrain comes up to speed and is not cause for concern.



Do not become overconfident in the ability of 4WD and AWD vehicles. Although a 4WD or AWD vehicle may accelerate better than two-wheel drive vehicle in low traction situations, it won't stop any faster than two-wheel drive vehicles. Always drive at a safe speed.

How your vehicle differs from other vehicles

SUV and trucks can differ from some other vehicles in a few noticeable ways. Your vehicle may be:

- Higher – to allow higher load carrying capacity and to allow it to travel over rough terrain without getting hung up or damaging underbody components.
- Shorter – to give it the capability to approach inclines and drive over the crest of a hill without getting hung up or damaging underbody components. All other things held equal, a shorter wheelbase may make your vehicle quicker to respond to steering inputs than a vehicle with a longer wheelbase.

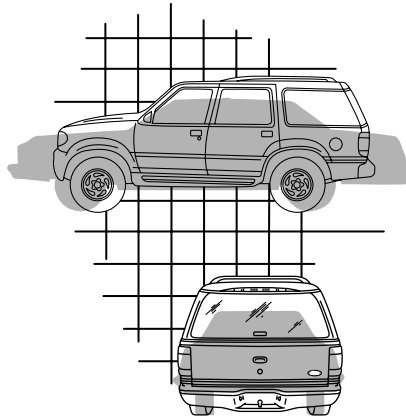

Tires, Wheels and Loading

- Narrower — to provide greater maneuverability in tight spaces, particularly in off-road use.

As a result of the above dimensional differences, SUV's and trucks often will have a higher center of gravity and a greater difference in center of gravity between the loaded and unloaded condition.

These differences that make your vehicle so versatile also make it handle differently than an ordinary passenger car.

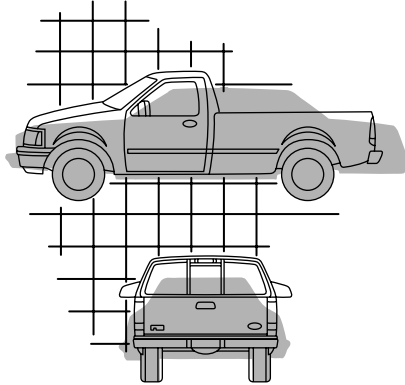

INFORMATION ABOUT UNIFORM TIRE QUALITY GRADING

New vehicles are fitted with tires that have a rating on them called Tire Quality Grades. The Quality grades can be found where applicable on the tire sidewall between tread shoulder and maximum section width. For example:

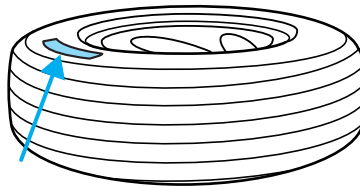

- **Treadwear 200 Traction AA Temperature A**

These Tire Quality Grades are determined by standards that the United States Department of Transportation has set.

Tire Quality Grades apply to new pneumatic tires for use on passenger cars. They do not apply to deep tread, winter-type snow tires, space-saver or temporary use spare tires, tires with nominal rim diameters of 10 to 12 inches or limited production tires as defined in Title 49 Code of Federal Regulations Part 575.104(c)(2).

U.S. Department of Transportation-Tire quality grades: The U.S. Department of Transportation requires Ford Motor Company to give you the following information about tire grades exactly as the government has written it.

Treadwear

The treadwear grade is a comparative rating based on the wear rate of the tire when tested under controlled conditions on a specified

Tires, Wheels and Loading

government test course. For example, a tire graded 150 would wear one and one-half (1 1/2) times as well on the government course as a tire graded 100. The relative performance of tires depends upon the actual conditions of their use, however, and may depart significantly from the norm due to variations in driving habits, service practices, and differences in road characteristics and climate.

Traction AA A B C

The traction grades, from highest to lowest are AA, A, B, and C. The grades represent the tire's ability to stop on wet pavement as measured under controlled conditions on specified government test surfaces of asphalt and concrete. A tire marked C may have poor traction performance.



The traction grade assigned to this tire is based on straight-ahead braking traction tests, and does not include acceleration, cornering, hydroplaning or peak traction characteristics.

Temperature A B C

The temperature grades are A (the highest), B and C, representing the tire's resistance to the generation of heat and its ability to dissipate heat when tested under controlled conditions on a specified indoor laboratory test wheel. Sustained high temperature can cause the material of the tire to degenerate and reduce tire life, and excessive temperature can lead to sudden tire failure. The grade C corresponds to a level of performance which all passenger car tires must meet under the Federal Motor Vehicle Safety Standard No. 109. Grades B and A represent higher levels of performance on the laboratory test wheel than the minimum required by law.



The temperature grade for this tire is established for a tire that is properly inflated and not overloaded. Excessive speed, underinflation, or excessive loading, either separately or in combination, can cause heat buildup and possible tire failure.

TIRES

Tires are designed to give many thousands of miles of service, but they must be maintained in order to get the maximum benefit from them.

Glossary of tire terminology

- **Safety Compliance Certification Label:** A label showing the OE (Original Equipment) tire sizes, recommended inflation pressure and the maximum weight the vehicle can carry.

Tires, Wheels and Loading

- **Tire Identification Number (TIN):** A number on the sidewall of each tire providing information about the tire brand and manufacturing plant, tire size and date of manufacture.
- **Inflation pressure:** A measure of the amount of air in a tire.
- **Standard load:** A class of P-metric or Metric tires designed to carry a maximum load at 35 psi [37 psi (2.5 bar) for Metric tires]. Increasing the inflation pressure beyond this pressure will not increase the tire's load carrying capability.
- **Extra load:** A class of P-metric or Metric tires designed to carry a heavier maximum load at 41 psi [43 psi (2.9 bar) for Metric tires]. Increasing the inflation pressure beyond this pressure will not increase the tire's load carrying capability.
- **kPa:** Kilopascal, a metric unit of air pressure.
- **PSI:** Pounds per square inch, a standard unit of air pressure.
- **Cold inflation pressure:** The tire pressure when the vehicle has been stationary and out of direct sunlight for an hour or more and prior to the vehicle being driven for 1 mile (1.6 km).
- **Recommended inflation pressure:** The cold inflation pressure found on the Safety Compliance Certification Label located on the B-Pillar or the edge of the driver's door.
- **B-pillar:** The structural member at the side of the vehicle behind the front door.
- **Bead area of the tire:** Area of the tire next to the rim.
- **Sidewall of the tire:** Area between the bead area and the tread.
- **Tread area of the tire:** Area of the perimeter of the tire that contacts the road when mounted on the vehicle.
- **Rim:** The metal support (wheel) for a tire or a tire and tube assembly upon which the tire beads are seated.

INSPECTING AND INFLATING YOUR TIRES

Safe operation of your vehicle requires that your tires are properly inflated. Remember that a tire can lose up to half of its air pressure without appearing flat.

Tires, Wheels and Loading

Every day before you drive, check your tires. If one looks lower than the others, use a tire gauge to check pressure of all tires and adjust if required.

At least once a month and before long trips, inspect each tire and check the tire pressure with a tire gauge (including spare, if equipped). Inflate all tires to the inflation pressure recommended by Ford Motor Company.

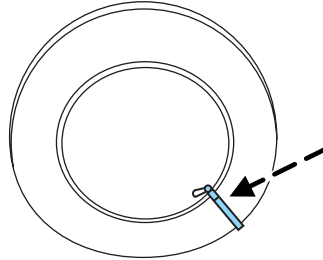

Inspecting your tires

Periodically inspect the tire treads for uneven or excessive wear and remove stones, nails, glass or other objects that may be wedged in the tread grooves. Check for holes or cuts that may permit air leakage from the tire and make necessary repairs.

Also inspect the tire sidewalls for cuts, bruises and other damage. If internal damage to the tire is suspected, have the tire demounted and inspected in case it needs to be repaired or replaced. For your safety, tires that are damaged should not be used because they are more likely to blow out or fail. Tires can be damaged during off-road use, so inspection after off-road use is also recommended.

Inflating your tires



When checking the air pressure in your tires, make sure that you carefully attach the air pressure gauge/air hose to the tire's valve stem directly on top of the valve stem. If you bend the valve stem, it may become damaged and cause an air leak.

Use a tire gauge to check the tire inflation pressure, including the spare (if equipped), at least monthly and before long trips. You are strongly urged to buy a reliable tire pressure gauge, as automatic service station gauges may be inaccurate. Ford recommends the use of a digital or dial type tire pressure gauge rather than a stick type tire pressure gauge.

Use the recommended cold inflation pressure for optimum tire performance and wear. Under-inflation or over-inflation may cause uneven treadwear patterns.

Tires, Wheels and Loading



Under-inflation is the most common cause of tire failures and may result in severe tire cracking, tread separation or "blowout", with unexpected loss of vehicle control and increased risk of injury. Under-inflation increases sidewall flexing and rolling resistance, resulting in heat buildup and internal damage to the tire. It also may result in unnecessary tire stress, irregular wear, loss of vehicle control and accidents. A tire can lose up to half of its air pressure and not appear to be flat!

Always inflate your tires to the Ford recommended inflation pressure even if it is less than the maximum inflation pressure information found on the tire. The Ford recommended tire inflation pressure is found on the Safety Compliance Certification Label which is located on the B-Pillar or the edge of the driver's door. Failure to follow the tire pressure recommendations can cause uneven treadwear patterns and adversely affect the way your vehicle handles.

Maximum Permissible Inflation Pressure is the tire manufacturer's maximum permissible pressure and/or the pressure at which the maximum load can be carried by the tire. This pressure is normally higher than the manufacturer's recommended cold inflation pressure which can be found on either the Safety Compliance Certification Label which is located on the B-Pillar or the edge of the driver's door. The cold inflation pressure should never be set lower than the recommended pressure on the Safety Compliance Certification Label.

When weather temperature changes occur, tire inflation pressures also change. A 10° F (6° C) temperature drop can cause a corresponding drop of 1 psi (7 kPa) in inflation pressure. Check your tire pressures frequently and adjust them to the proper pressure which can be found on the Safety Compliance Certification Label.

If you are checking tire pressure when the tire is hot, (i.e. driven more than 1 mile [1.6 km]), never "bleed" or reduce air pressure. The tires are hot from driving and it is normal for pressures to increase above recommended cold pressures. A hot tire at or below recommended cold inflation pressure could be significantly under-inflated.

To check the pressure in your tire(s):

1. Make sure the tires are cool, meaning they are not hot from driving even a mile.

Note: If you have to drive a distance to get air for your tire(s), check and record the tire pressure first and add the appropriate air pressure

162

Tires, Wheels and Loading

when you get to the pump. It is normal for tires to heat up and the air pressure inside to go up as you drive. Never “bleed” or reduce air pressure when tires are hot.

2. Remove the cap from the valve on one tire, then firmly press the tire gauge onto the valve and measure the pressure.

3. Add enough air to reach the recommended air pressure

Note: If you overfill the tire, release air by pushing on the metal stem in the center of the valve. Then recheck the pressure with your tire gauge.

4. Replace the valve cap.

5. Repeat this procedure for each tire, including the spare.

Note: Some spare tires require higher inflation pressure than the other tires. Check the Safety Compliance Certification Label on the B-pillar or the edge of the driver’s door for the recommended spare tire pressure.

6. Visually inspect the tires to make sure there are no nails or other objects embedded that could poke a hole in the tire and cause an air leak.

7. Check the sidewalls to make sure there are no gouges, cuts or bulges.

TIRE REPLACEMENT REQUIREMENTS

Your vehicle is equipped with tires designed to provide a safe ride and handling capability.



Only use replacement tires and wheels that are the same size and type (such as P-metric versus LT-metric or all-season versus all-terrain) as those originally provided by Ford Motor Company. Use of any tire or wheel not recommended by Ford Motor Company can affect the safety and performance of your vehicle, which could result in an increased risk of loss of vehicle control, vehicle rollover, personal injury and death. Additionally the use of non-recommended tires and wheels could cause steering, suspension, axle or transfer case/power transfer unit failure. If you have questions regarding tire replacement, see an authorized Ford or Lincoln Mercury dealer.

Make sure all tires and wheels on the vehicle are of the same size, type, tread design, brand, load-carrying capacity and speed rating because it can affect the safety and performance of your vehicle, which could result in an increased risk of loss of vehicle control, vehicle rollover, personal injury and death.

The tire pressure monitoring sensors mounted in the wheels (originally installed on your vehicle) are not designed to be used in after-market wheels.

Tires, Wheels and Loading

The installation of replacement tires with steel cord body plies in the tire sidewall may cause malfunction of the Tire Pressure Monitoring System (TPMS), and is not recommended (cord material information is molded on the tire sidewall). Additionally, if your vehicle was originally equipped with run-flat tires, replacing them with tires that are not identical to those originally fitted may cause malfunction of the TPMS, and is not recommended. Run-flat tires should not be used to replace regular tires. Always check your TPMS indicator immediately after replacing one or more tires on your vehicle. If the TPMS indicator is on, your TPMS is malfunctioning. Your replacement tire might be incompatible with your TPMS system, or some component of the TPMS system may be damaged.

Important: Remember to replace the spare tire when you replace the road tires on your vehicle. Even if it has never been used, the spare tire should be replaced because tires degrade over time.

Important: Remember to replace the wheel air valves when the road tires are replaced on your vehicle.

CHANGING THE TIRES

If you get a flat tire while driving:

- do not brake heavily.
- gradually decrease the vehicle's speed.
- hold the steering wheel firmly.
- slowly move to a safe place on the side of the road.

Note: If your vehicle is equipped with the tire pressure monitoring system (TPMS), the system indicator light will illuminate when the spare is in use. To restore the full functionality of the monitoring system, all road wheels equipped with tire pressure monitoring sensors must be mounted on the vehicle.

If your vehicle is equipped with TPMS, have a flat serviced by a dealer or a qualified technician in order to prevent damage to the TPMS sensor, refer to *Changing tires with TPMS* in the *Tires, Wheels and Loading* chapter. Replace the spare tire with a road tire as soon as possible.



The use of tire sealants may damage your tires. The use of tire sealants may also damage your Tire Pressure Monitoring System (if equipped).

Tires, Wheels and Loading

 If your vehicle is equipped with a tire pressure monitoring system, refer to *Tire Pressure Monitoring System (if equipped)* later in this chapter for important information. If the tire pressure monitor sensor becomes damaged, it will no longer function.

Dissimilar spare tire/wheel information (if equipped)

 Failure to follow these guidelines could result in an increased risk of loss of vehicle control, injury or death.

Your vehicle may be equipped with a dissimilar spare tire/wheel. A dissimilar spare tire/wheel is defined as a spare tire and/or wheel that is different in brand, size or appearance from the road tires and wheels. If you have a dissimilar spare tire/wheel, then it is intended for temporary use only. This means that if you need to use it, you should replace it as soon as possible with a road tire/wheel that is the same size and type as the road tires and wheels that were originally provided by Ford. If the dissimilar spare tire or wheel is damaged, it should be replaced rather than repaired.

When driving with the dissimilar spare tire/wheel, **do not:**

- Exceed 70 mph (113 km/h)
- Use more than one dissimilar spare tire/wheel at a time
- Use commercial car washing equipment
- Use snow chains on the end of the vehicle with the dissimilar spare tire/wheel

The usage of a dissimilar spare tire/wheel can lead to impairment of the following:

- Handling, stability and braking performance
- Comfort and noise
- Ground clearance and parking at curbs
- Winter weather driving capability
- Wet weather driving capability
- All-Wheel driving capability (if applicable)
- Load leveling adjustment (if applicable)

Tires, Wheels and Loading

When driving with the dissimilar spare tire/wheel additional caution should be given to:

- Towing a trailer
- Driving vehicles equipped with a camper body
- Driving vehicles with a load on the cargo rack

Drive cautiously when using a dissimilar spare tire/wheel and seek service as soon as possible.

Stopping and securing the vehicle

1. If you get a flat tire while driving, do not apply the brake heavily; instead, gradually decrease your speed. Hold the steering wheel firmly and slowly move to a safe place on the side of the road.
2. Park on a level surface, activate the hazard flashers and set the parking brake.
3. Place gearshift lever in P (Park) and turn engine OFF.

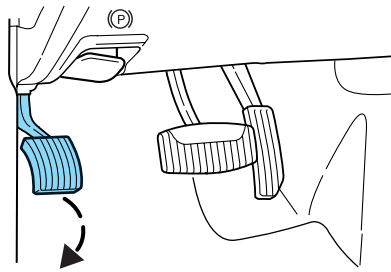

 When one of the rear wheels is off the ground, the transmission alone will not prevent the vehicle from moving or slipping off the jack, even if the transmission is in P (Park).

Note: Passengers should not remain in the vehicle when the vehicle is being jacked.

4. Block the wheel that is diagonally opposite of the flat tire using the wheel chock provided with your vehicle.

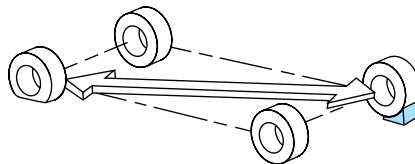

Tires, Wheels and Loading

Location of the spare tire and tools

The spare tire and tools for your vehicle are stowed in the following locations:

Tool	Location
Spare tire	Under the vehicle, just in front of the rear bumper. The spare tire winch drive nut is located at the rear center of the cargo area under a lid.
Jack, lug nut wrench, jack handle, wheel chock	Behind the rear seat under the carpeted floor lid in the cargo floor. The tools are located in a bag attached to the jack.

Removing the jack and tools

1. Open liftgate and remove the carpeted floor lid, then the jack.
2. Turn jack screw eyelet counterclockwise and remove the jack from the bracket.

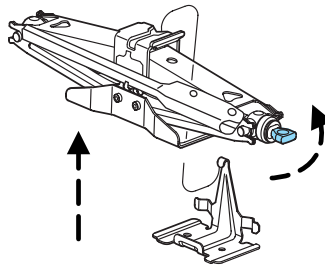

3. Remove the tools from the provided bag.

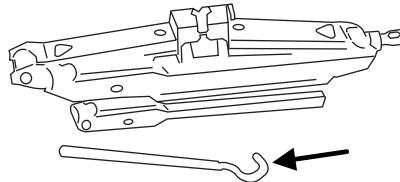

Tires, Wheels and Loading

Rotate the wrench socket out from the handle.

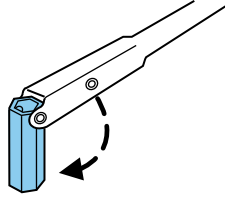

Removing the spare tire

Do not use an impact wrench on the winch drive nut. This will damage the spare tire winch.

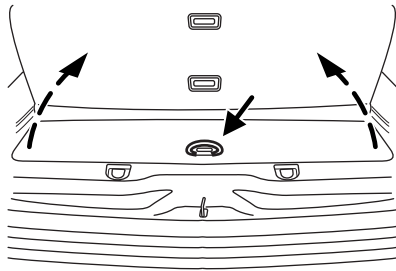

1. Open the cover from the carpeting on cargo floor to expose the winch drive nut.
2. Insert the lug wrench on the winch drive nut.

The wrench will stop moving and forward resistance to turning will be felt when properly engaged.

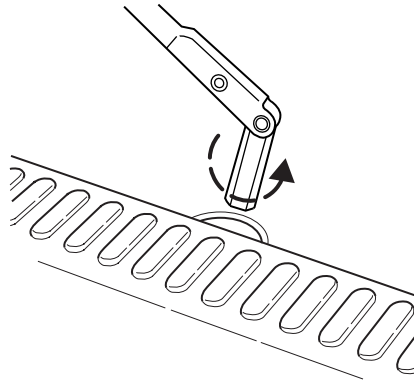

Tires, Wheels and Loading

3. Turn the wrench counterclockwise until the tire is lowered to the ground and the cable has slack. When turning the wrench, make sure that it does not scuff the kick plate.

4. Slide the tire rearward, lift one side and remove the retainer from the spare tire.

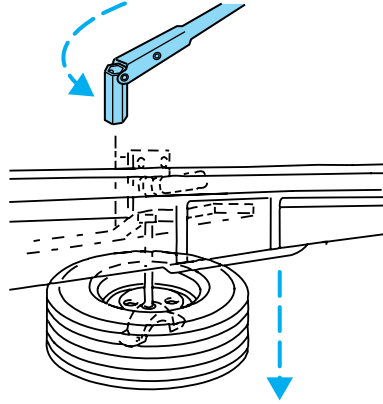

Changing the spare tire

 To prevent the vehicle from moving when you change a tire, be sure the parking brake is set, then block the wheel that is diagonally opposite (other end of the vehicle) to the tire being changed.

 If the vehicle slips off the jack, you or someone else could be seriously injured.

 Do not attempt to change a tire on the side of the vehicle close to moving traffic. Pull far enough off the road to avoid the danger of being hit when operating the jack or changing the wheel.

1. Use the tip of the lug wrench to remove the beauty cap by twisting the tip under the cap. The carpeted floor lid can be used as a kneeling pad.

2. Loosen each wheel lug nut by half a turn, but do not remove them until the wheel is raised off the ground.

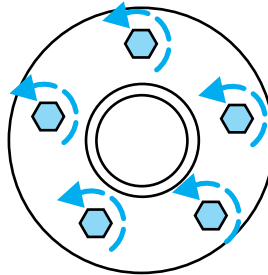

Tires, Wheels and Loading

3. Assemble the jack handle extension on the lug nut wrench by sliding the square end of the jack handle through the plastic grommet on the lug nut wrench and into the square hole on the other side.

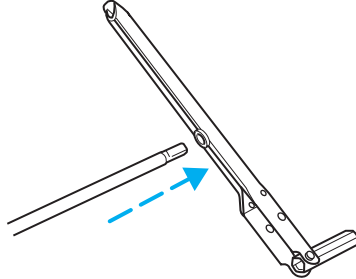

4. Position the jack according to the illustrated guides and turn the jack handle clockwise until the tire is a maximum of 1 inch (25 mm) off the ground.

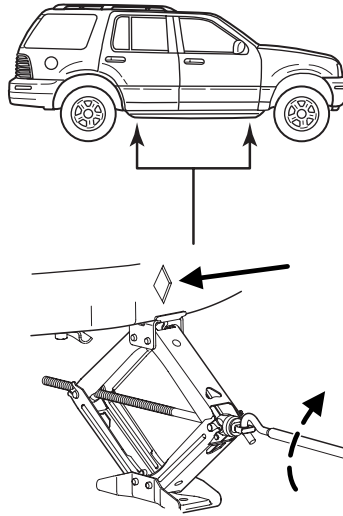

Tires, Wheels and Loading



To lessen the risk of personal injury, do not put any part of your body under the vehicle while changing a tire. Do not start the engine when your vehicle is on the jack. The jack is only meant for changing the tire.

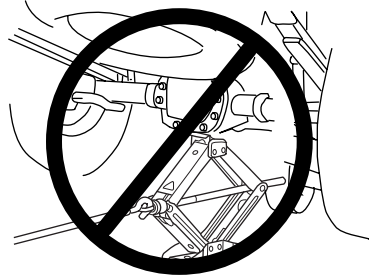

- **Never use the front or rear differential as a jacking point.**

5. Remove the lug nuts with the lug wrench.
6. Replace the flat tire with the spare tire, making sure the valve stem is facing outward. Reinstall the lug nuts, cone side in, until the wheel is snug against the hub. Do not fully tighten the lug nuts until the wheel has been lowered.
7. Lower the wheel by turning the jack handle counterclockwise.
8. Remove the jack and fully tighten the lug nuts in the order shown. Refer to *Wheel lug nut torque specifications* later in this chapter for the proper lug nut torque specification.

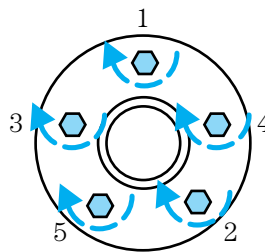

Stowing the flat/spare tire

Note: Failure to follow spare tire stowage instructions may result in failure of cable or loss of spare tire.

1. Lay the tire on the ground with the valve stem facing up, toward the vehicle.
2. Slide the wheel partially under the vehicle and install the retainer through the wheel center. Pull on the cable to align the components at the end of the cable.
3. Turn the lug wrench clockwise until the tire is raised to its stowed position underneath the vehicle. The effort to turn the jack handle

Tires, Wheels and Loading

increases significantly and the spare tire carrier ratchets or slips when the tire is raised to the maximum tightness. Tighten to the best of your ability, to the point where the ratchet/slip occurs, if possible. The spare tire carrier will not allow you to overtighten. If the spare tire carrier ratchets or slips with little effort, take the vehicle to your dealer for assistance at your earliest convenience.

4. Check that the tire lies flat against the frame and is properly tightened. Try to push or pull, then turn the tire to be sure it will not move. Loosen and retighten, if necessary. Failure to properly stow the spare tire may result in failure of the winch cable and loss of the tire.
5. If your vehicle is equipped with a spare tire lock and key, be sure to install the spare tire lock into the bumper drive tube with the spare tire lock key and jack handle.
6. Repeat this tightness check procedure when servicing the spare tire pressure (every six months, per *scheduled maintenance information*), or at any time that the spare tire is disturbed through service of other components.

Re-stowing the jack and tools

1. Unblock the wheels.
2. Stow the wheel ornament (if removed) in a safe location in the vehicle (such as the glove box or jack stowage compartment) so it will not become damaged. Re-install the wheel ornament onto the wheel once the tire is repaired or replaced.
3. Stow the jack and tools in their respective locations, making sure they are fully secured so they do not rattle when you drive.

WHEEL LUG NUT TORQUE SPECIFICATIONS

Retighten the lug nuts to the specified torque at 50–100 miles (80–160 km) after any wheel disturbance (rotation, flat tire, wheel removal, etc.).

Lug nut socket size/Bolt size	Wheel lug nut torque*	
	lb.ft.	N•m
Lug nut socket size: 3/4" (19 mm) hex Bolt size: 1/2 x 20	100	135
* Torque specifications are for nut and bolt threads free of dirt and rust. Use only Ford recommended replacement fasteners.		

Tires, Wheels and Loading



When a wheel is installed, always remove any corrosion, dirt and foreign materials present on the mounting surfaces of the wheel and the surface of the front disc brake hub and rotor that contacts the wheel. Installing wheels without correct metal-to-metal contact at the wheel mounting surfaces can cause the wheel nuts to loosen and the wheel to come off while the vehicle is in motion, resulting in loss of control.

Note: If there is corrosion on the area where the wheel contacts the hub, apply a thin film of grease or anti-seize compound on that area.

INFORMATION CONTAINED ON THE TIRE SIDEWALL

Federal law requires tire manufacturers to place standardized information on the sidewall of all tires. This information identifies and describes the fundamental characteristics of the tire and also provides a U.S. DOT Tire Identification Number for safety standard certification and in case of a recall.

Information on “P” type tires

P215/65R15 95H is an example of a tire size, load index and speed rating. The definitions of these items are listed below. (Note that the tire size, load index and speed rating for your vehicle may be different from this example.)

1. **P:** Indicates a tire, designated by the Tire and Rim Association (T&RA), that may be used for service on cars, SUVs, minivans and light trucks.

Note: If your tire size does not begin with a letter this may mean it is designated by either ETRTO (European Tire and Rim Technical Organization) or JATMA (Japan Tire Manufacturing Association).

2. **215:** Indicates the nominal width of the tire in millimeters from sidewall edge to sidewall edge. In general, the larger the number, the wider the tire.

3. **65:** Indicates the aspect ratio which gives the tire's ratio of height to width.

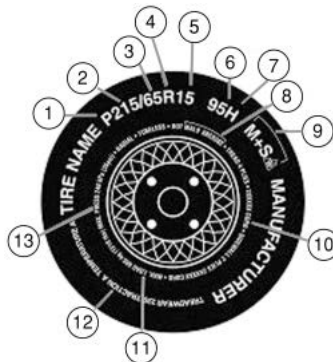

Tires, Wheels and Loading

4. **R:** Indicates a “radial” type tire.

5. **15:** Indicates the wheel or rim diameter in inches. If you change your wheel size, you will have to purchase new tires to match the new wheel diameter.

6. **95:** Indicates the tire’s load index. It is an index that relates to how much weight a tire can carry. You may find this information in your *Owner’s Guide*. If not, contact a local tire dealer.

Note: You may not find this information on all tires because it is not required by federal law.

7. **H:** Indicates the tire’s speed rating. The speed rating denotes the speed at which a tire is designed to be driven for extended periods of time under a standard condition of load and inflation pressure. The tires on your vehicle may operate at different conditions for load and inflation pressure. These speed ratings may need to be adjusted for the difference in conditions. The ratings range from 81 mph (130 km/h) to 186 mph (299 km/h). These ratings are listed in the following chart.

Note: You may not find this information on all tires because it is not required by federal law.

Letter rating	Speed rating - mph (km/h)
M	81 mph (130 km/h)
N	87 mph (140 km/h)
Q	99 mph (159 km/h)
R	106 mph (171 km/h)
S	112 mph (180 km/h)
T	118 mph (190 km/h)
U	124 mph (200 km/h)
H	130 mph (210 km/h)
V	149 mph (240 km/h)
W	168 mph (270 km/h)
Y	186 mph (299 km/h)

Note: For tires with a maximum speed capability over 149 mph (240 km/h), tire manufacturers sometimes use the letters ZR. For those with a maximum speed capability over 186 mph (299 km/h), tire manufacturers always use the letters ZR.

Tires, Wheels and Loading

8. **U.S. DOT Tire Identification Number (TIN):** This begins with the letters “DOT” and indicates that the tire meets all federal standards. The next two numbers or letters are the plant code designating where it was manufactured, the next two are the tire size code and the last four numbers represent the week and year the tire was built. For example, the numbers 317 mean the 31st week of 1997. After 2000 the numbers go to four digits. For example, 2501 means the 25th week of 2001. The numbers in between are identification codes used for traceability. This information is used to contact customers if a tire defect requires a recall.

9. **M+S or M/S:** Mud and Snow, or

AT: All Terrain, or

AS: All Season.

10. **Tire Ply Composition and Material Used:** Indicates the number of plies or the number of layers of rubber-coated fabric in the tire tread and sidewall. Tire manufacturers also must indicate the ply materials in the tire and the sidewall, which include steel, nylon, polyester, and others.

11. **Maximum Load:** Indicates the maximum load in kilograms and pounds that can be carried by the tire. Refer to the Safety Compliance Certification Label, which is located on the B-Pillar or the edge of the driver's door, for the correct tire pressure for your vehicle.

12. Treadwear, Traction and Temperature Grades

- **Treadwear:** The treadwear grade is a comparative rating based on the wear rate of the tire when tested under controlled conditions on a specified government test course. For example, a tire graded 150 would wear one and one-half (1½) times as well on the government course as a tire graded 100.
- **Traction:** The traction grades, from highest to lowest are AA, A, B, and C. The grades represent the tire's ability to stop on wet pavement as measured under controlled conditions on specified government test surfaces of asphalt and concrete. A tire marked C may have poor traction performance.
- **Temperature:** The temperature grades are A (the highest), B and C, representing the tire's resistance to the generation of heat and its ability to dissipate heat when tested under controlled conditions on a specified indoor laboratory test wheel.

13. **Maximum Permissible Inflation Pressure:** Indicates the tire manufacturers' maximum permissible pressure and/or the pressure at which the maximum load can be carried by the tire. This pressure is normally higher than the manufacturer's recommended cold inflation pressure which can be found on the Safety Compliance Certification

Tires, Wheels and Loading

Label which is located on the B-Pillar or the edge of the driver's door. The cold inflation pressure should never be set lower than the recommended pressure on the vehicle label.

The tire suppliers may have additional markings, notes or warnings such as standard load, radial tubeless, etc.

Additional information contained on the tire sidewall for "LT" type tires

"LT" type tires have some additional information beyond those of "P" type tires; these differences are described below:

1. **LT:** Indicates a tire, designated by the Tire and Rim Association (T&RA), that is intended for service on light trucks.

2. Load Range/Load Inflation

Limits: Indicates the tire's load-carrying capabilities and its inflation limits.

3. Maximum Load Dual lb. (kg)

at psi (kPa) cold: Indicates the maximum load and tire pressure when the tire is used as a dual; defined as four tires on the rear axle (a total of six or more tires on the vehicle).

4. **Maximum Load Single lb. (kg) at psi (kPa) cold:** Indicates the maximum load and tire pressure when the tire is used as a single; defined as two tires (total) on the rear axle.

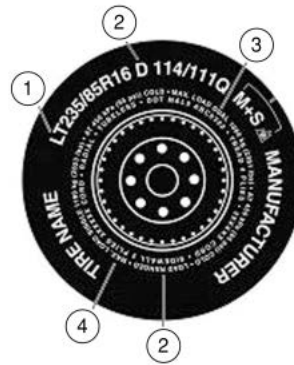

Tires, Wheels and Loading

Information on “T” type tires

“T” type tires have some additional information beyond those of “P” type tires; these differences are described below:

T145/80D16 is an example of a tire size.

Note: The temporary tire size for your vehicle may be different from this example.

1. **T:** Indicates a type of tire, designated by the Tire and Rim Association (T&RA), that is intended for temporary service on cars, SUVs, minivans and light trucks.

2. **145:** Indicates the nominal width of the tire in millimeters from sidewall edge to sidewall edge. In general, the larger the number, the wider the tire.

3. **80:** Indicates the aspect ratio which gives the tire’s ratio of height to width. Numbers of 70 or lower indicate a short sidewall.

4. **D:** Indicates a “diagonal” type tire.

R: Indicates a “radial” type tire.

5. **16:** Indicates the wheel or rim diameter in inches. If you change your wheel size, you will have to purchase new tires to match the new wheel diameter.

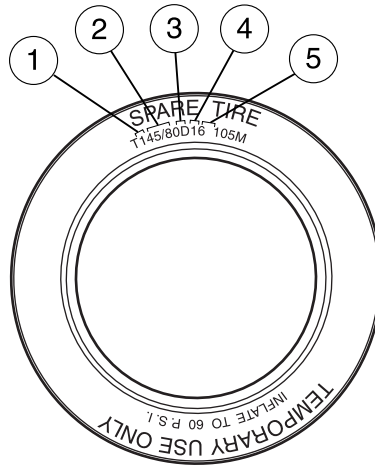

Location of the Safety Compliance Certification Label

You will find a Safety Compliance Certification Label containing tire inflation pressure by tire size and other important information located on the B-Pillar or the edge of the driver’s door. Refer to the payload description and graphic in the *Vehicle loading — with and without a trailer* section.

Tires, Wheels and Loading

TIRE CARE

Improper or inadequate vehicle maintenance can also cause tires to wear abnormally. Here are some of the important maintenance items:

Tire wear

Measure and inspect the tire tread on all your tires periodically. Advanced and unusual tire wear can reduce the ability of tread to grip the road in adverse (wet, snowy, etc.) conditions. Visually check your tires for uneven wear, looking for high and low areas or unusually smooth areas. Also check for signs of tire damage.

When the tread is worn down to 1/16th of an inch (2 mm), tires must be replaced to prevent your vehicle from skidding and hydroplaning. Built-in treadwear indicators, or “wear bars”, which look like narrow strips of smooth rubber across the tread will appear on the tire when the tread is worn down to 1/16th of an inch (2 mm). When the tire tread wears down to the same height as these “wear bars”, the tire is worn out and should be replaced.

Inspect your tires frequently for any of the following conditions and replace them if one or more of the following conditions exist:

- Fabric showing through the tire rubber
- Bulges in the tread or sidewalls
- Cracks or cuts on the sidewalls
- Cracks in the tread groove
- Impact damage resulting from use
- Separation in the tread
- Separation in the sidewall
- Severe abrasion on the sidewall

If your vehicle has a leak in the exhaust system, a road tire or the spare tire may be exposed to hot exhaust temperatures requiring the tire to be replaced.

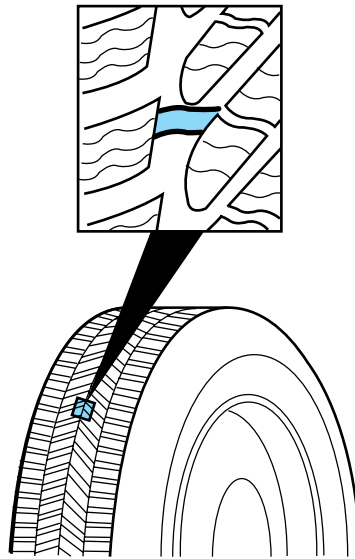

Tires, Wheels and Loading

Safety practices

Driving habits have a great deal to do with your tire mileage and safety.

- Observe posted speed limits
- Avoid fast starts, stops and turns
- Avoid potholes and objects on the road
- Do not run over curbs or hit the tire against a curb when parking



If your vehicle is stuck in snow, mud, sand, etc., **do not** rapidly spin the tires; spinning the tires can tear the tire and cause an explosion. A tire can explode in as little as three to five seconds.



Never spin the tires in excess of the 35 mph (55 km/h) point indicated on the speedometer.

Highway hazards

No matter how carefully you drive there's always the possibility that you may eventually have a flat tire on the highway. Drive slowly to the closest safe area out of traffic. This may further damage the flat tire, but your safety is more important.

If you feel a sudden vibration or ride disturbance while driving, or you suspect your tire or vehicle has been damaged, immediately reduce your speed. Drive with caution until you can safely pull off the road. Stop and inspect the tires for damage. If a tire is under-inflated or damaged, deflate it, remove wheel and replace it with your spare tire and wheel. If you cannot detect a cause, have the vehicle towed to the nearest repair facility or tire dealer to have the vehicle inspected.

Tire and wheel alignment

A bad jolt from hitting a curb or pothole can cause the front end of your vehicle to become misaligned or cause damage to your tires. If your vehicle seems to pull to one side when you're driving, the wheels may be out of alignment. Have a qualified technician at a Ford or Lincoln Mercury dealer check the wheel alignment periodically.

Wheel misalignment in the front or the rear can cause uneven and rapid treadwear of your tires and should be corrected by a qualified technician at a Ford or Lincoln Mercury dealer. Front wheel drive (FWD) vehicles and those with an independent rear suspension (if equipped) may require alignment of all four wheels.

Tires, Wheels and Loading

The tires should also be balanced periodically. An unbalanced tire and wheel assembly may result in irregular tire wear.

Tire rotation

Rotating your tires at the recommended interval (as indicated in the *scheduled maintenance information* that comes with your vehicle) will help your tires wear more evenly, providing better tire performance and longer tire life. Unless otherwise specified, rotate the tires approximately every 5,000 miles (8,000 km).

- Front Wheel Drive (FWD) vehicles (front tires at top of diagram)

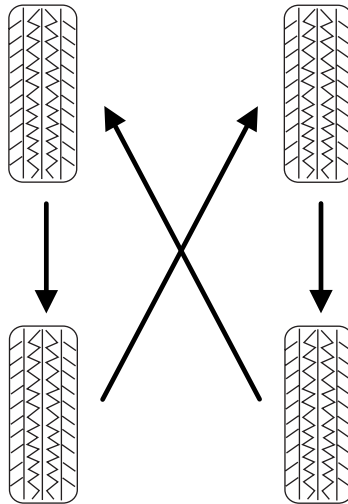

Tires, Wheels and Loading

- Rear Wheel Drive (RWD) vehicles/Four Wheel Drive (4WD)/ All Wheel Drive (AWD) vehicles (front tires at top of diagram)

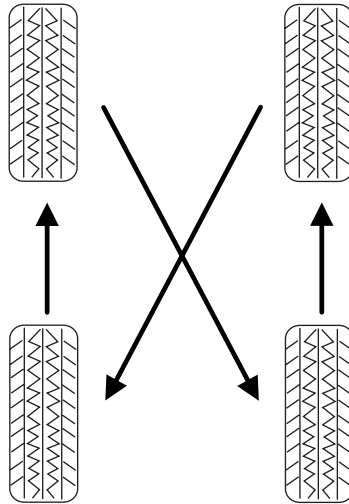

Sometimes irregular tire wear can be corrected by rotating the tires.

Note: If your tires show uneven wear ask a qualified technician at a Ford or Lincoln Mercury dealership to check for and correct any wheel misalignment, tire imbalance or mechanical problem involved before tire rotation.

Note: Your vehicle may be equipped with a dissimilar spare tire/wheel. A dissimilar spare tire/wheel is defined as a spare tire and/or wheel that is different in brand, size or appearance from the road tires and wheels. If you have a dissimilar spare tire/wheel it is intended for temporary use only and should not be used in a tire rotation.

Note: After having your tires rotated, inflation pressure must be checked and adjusted to the vehicle requirements.

Tires, Wheels and Loading

TIRE PRESSURE MONITORING SYSTEM (TPMS)(IF EQUIPPED)

When the Tire Pressure Monitoring System warning light is lit, one or more of your tires is significantly under-inflated. You should stop and check your tires as soon as possible, and inflate them to the proper pressure as indicated on the vehicle's tire information placard (label). Driving on a significantly under-inflated tire causes the tire to overheat and can eventually lead to tire failure. Under-inflation also reduces fuel efficiency and tire tread life, and may affect the vehicle's handling and stopping ability. Even if your vehicle is equipped with a Tire Pressure Monitoring System, it is still important that you manually check the inflation pressure of your tires regularly. Each tire, including the spare, should be checked monthly when cold and set to the recommended inflation pressure which can be found on either the Safety Compliance Certification Label which is located on the B-Pillar or the edge of the driver's door.

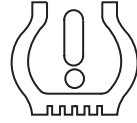

The Tire Pressure Monitoring System is NOT a substitute for manually checking tire pressure. The tire pressure should be checked periodically (at least monthly) using a tire gauge, see *Inspecting and inflating your tires* in this chapter. Failure to properly maintain your tire pressure could increase the risk of tire failure, loss of control, vehicle rollover and personal injury.

Changing tires with TPMS

It is recommended that you always have your tires serviced by a dealer or qualified technician. **Each road tire is equipped with a tire pressure sensor mounted on the wheel inside the tire connected to the valve stem. The tire pressure sensor must be unbolted from the wheel prior to tire removal. The sensor can be removed by loosening the nut at the valve stem. Failure to remove the sensor may damage it.** The rubber grommet (washer) between the wheel and the tire pressure sensor needs to be replaced whenever the sensor is removed to minimize air leaks.

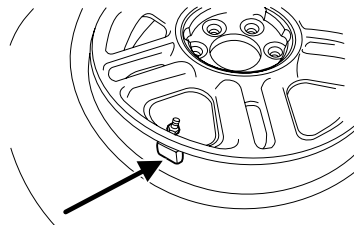

Tires, Wheels and Loading

The tire pressure should be checked periodically (at least monthly) using an accurate tire gauge, refer to *Inspecting and inflating your tires* in this chapter.

Understanding your Tire Pressure Monitoring System (TPMS)

The Tire Pressure Monitoring System measures pressure in your four road tires and sends the tire pressure readings to your vehicle every minute while you are driving and once an hour when your vehicle is parked. The Low Tire Warning Lamp will turn ON if the tire pressure is 25% below the pressure listed on the Safety Compliance Certification Label (approximately 6 to 9 psi below the manufacturer's recommend tire pressure). If the tire pressure increases 2 psi above the "Light ON" threshold, then the TPMS light will turn OFF. Once the light is illuminated, your tires are under inflated and need to be inflated to the manufacturer's recommended tire pressure. Even if the light turns ON and a short time later turns OFF, your tire pressure still needs to be checked.

In short, once the light has turned ON, at least one tire may be under inflated.

When your temporary spare tire is installed

When one of your road tires needs to be replaced with the temporary spare, the TPMS system will continue to identify an issue to remind you that the damaged road wheel/tire needs to be repaired and put back on your vehicle. During this time, the low tire warning light can periodically return or stay on, depending on the state of the damaged road wheel/tire. This will include the message center messages (if equipped).

To restore the full functionality of the Tire Pressure Monitoring System, have the damaged road wheel/tire repaired and remounted on your vehicle. For additional information, refer to *Changing tires with TPMS* in this section.

When you believe your system is not operating properly

The main function of the Tire Pressure Monitoring System is to warn you when your tires need air. It can also warn you in the event the system is no longer capable of functioning as intended. Please refer to the following chart for information concerning your Tire Pressure Monitoring System:

Tires, Wheels and Loading

Low Tire Warning Light	Customer Action Required
Solid Warning Light	<ol style="list-style-type: none"> 1. Check your tire pressure to ensure they are properly inflated, refer to <i>Inspecting and inflating your tires</i> in this chapter. Ford recommends the use of a digital or dial type tire pressure gauge rather than a stick type tire pressure gauge for increased accuracy. 2. After inflating your tires to the manufacturer's recommended air pressure as shown on the Safety Compliance Certification Label (located on the driver's door or the B-Pillar), the vehicle must be driven for at least two minutes at 20 mph (32 km/h) to guarantee that the light will turn off. 3. If the light remains on even after these steps have been taken, have the system inspected by your servicing dealership
Flashing Warning Light (flashes for 20 to 30 seconds either at start-up or while driving)	<ol style="list-style-type: none"> 1. Your spare tire is in use. Repair the damaged road wheel and re-mount it on the vehicle to restore system functionality. For a description of how the system functions under these conditions, refer to <i>When You Have a Flat Tire</i> in this section. 2. If your tires are inflated to the manufacturer's recommended tire pressure, and your spare tire is not in use, and a flashing low tire warning light is still present, have the system inspected by your servicing dealership.

When inflating your tires

When putting air into your tires (such as at a gas station or in your garage), the Tire Pressure Monitoring System may not respond immediately to the air added to your tires. Here are the details:

- The tire pressure monitor sensors mounted in your wheels updates your vehicle with tire pressure information only once every minute,

Tires, Wheels and Loading

therefore it may take up to a minute for the light to turn off after you have filled your tires to the recommended tire pressure.

- If your vehicle has been parked for over 15 minutes, the sensors go into a low power mode to conserve battery life and therefore only transmit about once an hour. If you inflate your tires under these conditions, the light could take up to an hour to turn off after you have filled your tires to the recommended tire pressure.

For these reasons, the low tire warning light is NOT a substitute for using an accurate tire gauge when checking and filling your tires. The best way to turn off the low tire warning light is to fill your tires to the recommended tire pressure and drive your vehicle — the tire pressure sensors in your wheels will update your vehicle with the updated tire pressure when your vehicle reaches a speed of 20 mph (32 km/h) for at least a minute.

How temperature affects your tire pressure

The Tire Pressure Monitoring System (TPMS) monitors tire pressure in each pneumatic tire. The pressure in each tire is dependent upon several factors, one of them being the contained air temperature (temperature of the air inside the tire). As the contained air temperature increases, the tire pressure also increases. While driving in a normal manner, a typical passenger tire inflation pressure may increase approximately 2 to 4 psi (14 to 28 kPa) from a cold start situation. This increase in tire pressure is due to an increase in the contained air temperature. Contained air temperature is dependent upon several factors such as rate of tire rotation, tire deflection, amount of braking, etc. In similar manner, the tire pressure will decrease if the contained air temperature decreases. For example, if the vehicle is stationary over night with the outside temperature significantly lower than the daytime temperature, the tire pressure may decrease approximately 3 psi (20.7 kPa) for a drop of 30° F (16.6° C) in ambient temperature. This lower pressure value may be detected by the TPMS as being significantly lower than the cold pressure indicated on your vehicles Safety Compliance Certification Label, and activate the TPMS warning for low tire pressure. If the low warning light is on, visually check each tire to verify that no tire is flat. If one or more tires are flat, repair as necessary. If all tires appear to be inflated, carefully drive the vehicle to the nearest location where air can be added to the tires. Turn the ignition to the “off” position. Inflate all the tires to the recommended cold pressure.

The Tire Pressure Monitoring System complies with part 15 of the FCC rules and with RS-210 of Industry Canada. Operation is subject to the following two conditions: (1) This device may not cause harmful

Tires, Wheels and Loading

interference, and (2) This device must accept any interference received, including interference that may cause undesired operation.



The Tire Pressure Monitoring System is NOT a substitute for manually checking tire pressure. The tire pressure should be checked periodically (at least monthly) using a tire gauge, see *Inspecting and inflating your tires* in this chapter. Failure to properly maintain your tire pressure could increase the risk of tire failure, loss of control, vehicle rollover and personal injury.

USING SNOW TIRES AND TRACTION DEVICES



Snow tires must be the same size and grade as the tires you currently have on your vehicle.

The tires on your vehicle have all-weather treads to provide traction in rain and snow. However, in some climates, using snow tires or traction devices may be necessary. Ford offers tire cables as a Ford approved accessory and recommends use of these or SAE class “S” tire cables. See your dealer or qualified service technician for more information on tire cables for your vehicle.

Follow these guidelines when using snow tires and traction devices:

- Cables or chains should only be used on the rear wheels.
- Install cables or chains securely, verifying that the cables or chains do not touch any wiring, brake lines or fuel lines.
- Drive cautiously. If you hear the cables or chains rub or bang against the vehicle, stop and retighten them. If this does not work, remove the cables or chains to prevent vehicle damage.
- Avoid overloading your vehicle.
- Remove the cables or chains when they are no longer needed.
- Do not use cables or chains on dry roads.
- Do not exceed 30 mph (48 km/h) with tire cables or chains on your vehicle.

Consult your dealer for information on other Ford approved methods of traction control.

VEHICLE LOADING – WITH AND WITHOUT A TRAILER

This section will guide you in the proper loading of your vehicle and/or trailer, to keep your loaded vehicle weight within its design rating

186

2005 Explorer (exp)
Owners Guide (post-2002-fmt)
USA (fus)

Tires, Wheels and Loading

capability, with or without a trailer. Properly loading your vehicle will provide maximum return of vehicle design performance. Before loading your vehicle, familiarize yourself with the following terms for determining your vehicle's weight ratings, with or without a trailer, from the vehicle's Safety Compliance Certification Label:

Base Curb Weight – is the weight of the vehicle including a full tank of fuel and all standard equipment. It does not include passengers, cargo, or optional equipment.

Vehicle Curb Weight – is the weight of your new vehicle when you picked it up from your dealer plus any aftermarket equipment.

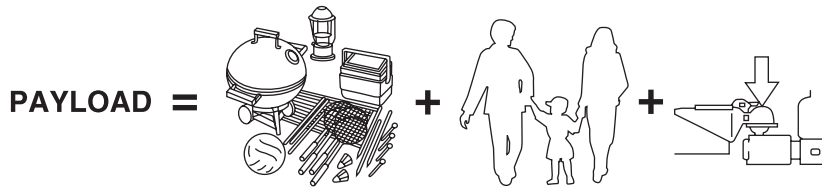

Payload – is the combined weight of cargo and passengers that the vehicle is carrying. The maximum payload for your vehicle can be found on the Safety Compliance Certification Label on the B-Pillar or the edge of the driver's door. Look for **“THE COMBINED WEIGHT OF OCCUPANTS AND CARGO SHOULD NEVER EXCEED XXX kg OR XXX lb.”** for maximum payload. The payload listed on the Safety Compliance Certification Label is the maximum payload for the vehicle as built by the assembly plant. If any aftermarket or dealer installed equipment has been installed on the vehicle, the weight of the equipment must be subtracted from the payload listed on the Safety Compliance Certification Label in order to determine the new payload.



The appropriate loading capacity of your vehicle can be limited either by volume capacity (how much space is available) or by payload capacity (how much weight the vehicle should carry). Once you have reached the maximum payload of your vehicle, do not add more cargo, even if there is space available. Overloading or improperly loading your vehicle can contribute to loss of vehicle control and vehicle rollover.

Tires, Wheels and Loading

Example only:

TIRE AND LOAD INFORMATION			
SEE OWNERS MANUAL FOR ADDITIONAL INFORMATION			
The combined weight of occupants and cargo should never exceed XXX kg or XXX lbs.			
SEATING CAPACITY	TOTAL: 5	FRONT: 2	REAR: 3
ORIGINAL TIRE SIZE		COLD TIRE INFLATION PRESSURE	
FRONT	P195 / 70R14	FRONT	200KPA, 29PSI
REAR	P195 / 70R14	REAR	200KPA, 29PSI
SPARE TIRE SIZE		COLD TIRE INFLATION PRESSURE	
T125/70D15		420KPA, 50PSI	

TIRE AND LOAD INFORMATION			
SEE OWNERS MANUAL FOR ADDITIONAL INFORMATION			
RENSEIGNEMENTS RELATIFS AUX PNEUS ET À LA CHARGE			
CONSULTER LE GUIDE DU PROPRIÉTAIRE POUR DE PLUS AMPLES RENSEIGNEMENTS			
The combined weight of occupants and cargo should never exceed ^{kg or} PM, ^{kg ou} P.M. ^{lbs.} L.			
La charge du véhicule (occupants et bagages) ne doit jamais dépasser ^{PM, kg ou} P.M. ^{kg ou} P.M. ^{lbs.} L.			
SEATING CAPACITY	TOTAL: TS	FRONT: FS	REAR: RS
NOMBRE DE PLACES	TOTAL:	AVANT:	ARRIÈRE:
ORIGINAL TIRE SIZE		COLD TIRE INFLATION PRESSURE	
DIMENSIONS DES PNEUS D'ORIGINE		PRESSION DE GONFLAGE À FROID	
FRONT/ AVANT	FTIREXXXXXE	FRONT/ AVANT	FKPA KPA, FPS PSI
REAR/ ARRIÈRE	RTIREXXXXXE	REAR/ ARRIÈRE	RKPA KPA, RPS PSI
SPARE TIRE SIZE		COLD TIRE INFLATION PRESSURE	
DIMENSION DU PNEU SECOURS		PRESSION DE GONFLAGE À FROID	
STIREXXXXXE		SKP KPA, SPS PSI	

CARGO

=



+

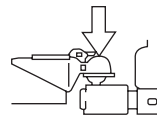

Cargo Weight – includes all weight added to the Base Curb Weight, including cargo and optional equipment. When towing, trailer tongue load or king pin weight is also part of cargo weight.

188

2005 Explorer (exp)
 Owners Guide (post-2002-fmt)
 USA (fus)

Tires, Wheels and Loading

GAW (Gross Axle Weight) – is the total weight placed on each axle (front and rear) – including vehicle curb weight and all payload.

GAWR (Gross Axle Weight Rating) – is the maximum allowable weight that can be carried by a single axle (front or rear). **These numbers are shown on the Safety Compliance Certification Label located on the B-Pillar or the edge of the driver's door. The total load on each axle must never exceed its GAWR.**

 Exceeding the Safety Compliance Certification Label axle weight rating limits could result in substandard vehicle handling or performance, engine, transmission and/or structural damage, serious damage to the vehicle, loss of control and personal injury.

Note: For trailer towing information refer to *Trailer towing* found in this chapter or the *RV and Trailer Towing Guide* provided by your dealership.

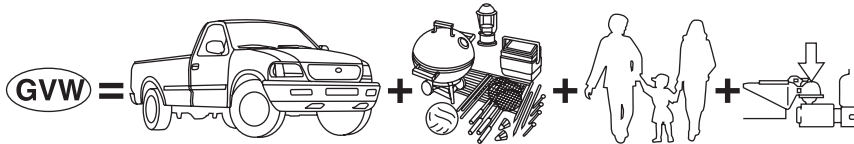

GVW (Gross Vehicle Weight) – is the Vehicle Curb Weight + cargo + passengers.

Tires, Wheels and Loading

GVWR (Gross Vehicle Weight Rating) – is the maximum allowable weight of the fully loaded vehicle (including all options, equipment, passengers and cargo). **The GVWR is shown on the Safety Compliance Certification Label located on the B-Pillar or the edge of the driver's door. The GVW must never exceed the GVWR.**

Sample Safety Compliance Certification Label <small>(Refer to actual label on your vehicle)</small>			
Front GAWR	GVWR	Rear GAWR	
MFD. BY FORD MOTOR CO. IN U.S.A.			
DATE: 06/95	GVWR: 6250 LB/2834 KG		
FRONT GAWR: 3450 LB 1584KG	WITH TIRES RIMS	REAR GAWR: 3777 LB 1713KG	WITH TIRES RIMS
P265/75R15SL 15X7.5J AT 30 PSI COLD		P265/75R15SL 15X7.5J AT 30 PSI COLD	
THIS VEHICLE CONFORMS TO ALL APPLICABLE FEDERAL MOTOR VEHICLE SAFETY STANDARDS IN EFFECT ON THE DATE OF MANUFACTURE SHOWN ABOVE.			
XXXXXXXXXXXX		XXXXXXXXXXXX	
VIN: 1FTEX14H 0 SKB 00000		F0018	
TYPE: XXXXXXXXXXXXXXXXX		TC183	
			
EXT PNT: XXXXXX XXXXXX			DSO:
WD	TYPE-GVW	BODY	TRANS
155	REM	E	HBB
			TAPE
			SPRINGS
			M4

 Exceeding the Safety Compliance Certification Label vehicle weight rating limits could result in substandard vehicle handling or performance, engine, transmission and/or structural damage, serious damage to the vehicle, loss of control and personal injury.

$$\text{GCW} = \text{GVW} +$$

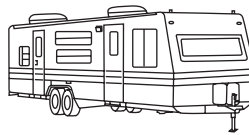

GCW (Gross Combined Weight) – is the weight of the loaded vehicle (GVW) plus the weight of the fully loaded trailer.

GCWR (Gross Combined Weight Rating) – is the maximum allowable weight of the vehicle and the loaded trailer – including all cargo and passengers – that the vehicle can handle without risking damage.

(Important: The towing vehicle's braking system is rated for operation at GVWR, not at GCWR.) Separate functional brakes should be used for safe control of towed vehicles and for trailers where the GCW of the towing vehicle plus the trailer exceed the GVWR of the towing vehicle.

The GCW must never exceed the GCWR.

Maximum Loaded Trailer Weight – is the highest possible weight of a fully loaded trailer the vehicle can tow. It assumes a vehicle with only

Tires, Wheels and Loading

mandatory options, no cargo (internal or external), a tongue load of 10–15% (conventional trailer) or king pin weight of 15–25% (fifth wheel trailer), and driver only (150 lb. [68 kg]). **Consult your dealership (or the *RV and Trailer Towing Guide* provided by your dealership) for more detailed information.**

Tongue Load or Fifth Wheel King Pin Weight – refers to the amount of the weight that a trailer pushes down on a trailer hitch.

Examples: For a 5,000 lb. (2,268 kg) conventional trailer, multiply 5,000 by 0.10 and 0.15 to obtain a proper tongue load range of 500 to 750 lb. (227 to 340 kg). For an 11,500 lb. (5,216 kg) fifth wheel trailer, multiply by 0.15 and 0.25 to obtain a proper king pin load range of 1,725 to 2,875 lb. (782 to 1,304 kg)



Do not exceed the GVWR or the GAWR specified on the Safety Compliance Certification Label.



Do not use replacement tires with lower load carrying capacities than the originals because they may lower the vehicle's GVWR and GAWR limitations. Replacement tires with a higher limit than the originals do not increase the GVWR and GAWR limitations.



Exceeding any vehicle weight rating limitation could result in serious damage to the vehicle and/or personal injury.

Steps for determining the correct load limit:

1. Locate the statement “The combined weight of occupants and cargo should never exceed XXX kg or XXX lbs.” on your vehicle's placard.
2. Determine the combined weight of the driver and passengers that will be riding in your vehicle.
3. Subtract the combined weight of the driver and passengers from XXX kg or XXX lbs.
4. The resulting figure equals the available amount of cargo and luggage load capacity. For example, if the “XXX” amount equals 1,400 lbs. and there will be five 150 lb. passengers in your vehicle, the amount of available cargo and luggage load capacity is 650 lbs. (1400–750 (5 x 150) = 650 lb.). In metric units (635–340 (5 x 68) = 295 kg.)
5. Determine the combined weight of luggage and cargo being loaded on the vehicle. That weight may not safely exceed the available cargo and luggage load capacity calculated in Step 4.

Tires, Wheels and Loading

6. If your vehicle will be towing a trailer, load from your trailer will be transferred to your vehicle. Consult this manual to determine how this reduces the available cargo and luggage load capacity of your vehicle.

The following gives you a few examples on how to calculate the available amount of cargo and luggage load capacity:

- Another example for your vehicle with 1400 lb. (635 kg) of cargo and luggage capacity. You decide to go golfing. Is there enough load capacity to carry you, 4 of your friends and all the golf bags? You and four friends average 220 lb. (99 kg) each and the golf bags weigh approximately 30 lb. (13.5 kg) each. The calculation would be: $1400 - (5 \times 220) - (5 \times 30) = 1400 - 1100 - 150 = 150$ lb. Yes, you have enough load capacity in your vehicle to transport four friends and your golf bags. In metric units, the calculation would be: $635 \text{ kg} - (5 \times 99 \text{ kg}) - (5 \times 13.5 \text{ kg}) = 635 - 495 - 67.5 = 72.5$ kg.
- A final example for your vehicle with 1400 lb. (635 kg) of cargo and luggage capacity. You and one of your friends decide to pick up cement from the local home improvement store to finish that patio you have been planning for the past 2 years. Measuring the inside of the vehicle with the rear seat folded down, you have room for 12-100 lb. (45 kg) bags of cement. Do you have enough load capacity to transport the cement to your home? If you and your friend each weigh 220 lb. (99 kg), the calculation would be: $1400 - (2 \times 220) - (12 \times 100) = 1400 - 440 - 1200 = -240$ lb. No, you do not have enough cargo capacity to carry that much weight. In metric units, the calculation would be: $635 \text{ kg} - (2 \times 99 \text{ kg}) - (12 \times 45 \text{ kg}) = 635 - 198 - 540 = -103$ kg. You will need to reduce the load weight by at least 240 lb. (104 kg). If you remove 3-100 lb. (45 kg) cement bags, then the load calculation would be:
 $1400 - (2 \times 220) - (9 \times 100) = 1400 - 440 - 900 = 60$ lb. Now you have the load capacity to transport the cement and your friend home. In metric units, the calculation would be: $635 \text{ kg} - (2 \times 99 \text{ kg}) - (9 \times 45 \text{ kg}) = 635 - 198 - 405 = 32$ kg.

The above calculations also assume that the loads are positioned in your vehicle in a manner that does not overload the Front or the Rear Gross Axle Weight Rating specified for your vehicle on the Safety Compliance Certification Label found on the edge of the driver's door.

Tires, Wheels and Loading

Special loading instructions for owners of pickup trucks and utility-type vehicles



For important information regarding safe operation of this type of vehicle, see the *Preparing to drive your vehicle* section in the *Driving* chapter of this *Owner's Guide*.



Loaded vehicles may handle differently than unloaded vehicles. Extra precautions, such as slower speeds and increased stopping distance, should be taken when driving a heavily loaded vehicle.

Your vehicle can haul more cargo and people than most passenger cars. Depending upon the type and placement of the load, hauling cargo and people may raise the center of gravity of the vehicle.

Calculating the load your vehicle can carry/tow

1. Use the appropriate maximum GCWR chart (in the *Trailer towing* section in this chapter) for your type of engine and rear axle ratio.
2. Weigh your vehicle without cargo. To obtain correct weights, take your vehicle to a shipping company or an inspection station for trucks.
3. Subtract your loaded weight from the maximum GCWR in the chart. This is the maximum trailer weight your vehicle can tow. It must be below the maximum trailer weight shown in the chart.

TRAILER TOWING

Trailer towing with your vehicle may require the use of a trailer tow option package.

Trailer towing puts additional loads on your vehicle's engine, transmission, axle, brakes, tires, and suspension. For your safety and to maximize vehicle performance, be sure to use the proper equipment while towing.

Follow these guidelines to ensure safe towing procedure:

- Stay within your vehicle's load limits.
- Thoroughly prepare your vehicle for towing. Refer to *Preparing to tow* in this chapter.
- Use extra caution when driving while trailer towing. Refer to *Driving while you tow* in this chapter.
- Service your vehicle more frequently if you tow a trailer. Refer to the severe duty schedule in the scheduled maintenance guide.

Tires, Wheels and Loading

- Do not tow a trailer until your vehicle has been driven at least 500 miles (800 km).
- Refer to the instructions included with towing accessories for the proper installation and adjustment specifications.

Do not exceed the maximum loads listed on the Safety Compliance Certification label. For load specification terms found on the label, refer to *Vehicle loading* in this chapter when figuring the total weight of your vehicle.

Your vehicle is equipped with a standard Class II integrated hitch and requires only a draw bar and ball with a 19 mm (3/4 inch) shank diameter. An optional Class III/Class IV hitch is also available.

Note: Do not exceed the GVWR or the GAWR specified on the certification label.



Towing trailers beyond the maximum recommended gross trailer weight exceeds the limit of the vehicle and could result in engine damage, transmission damage, structural damage, loss of vehicle control, vehicle rollover and personal injury.

4x2			
GCWR (Gross Combined Weight Rating)/Trailer Weight			
Engine	Rear axle ratio	Maximum GCWR-lb. (kg)	Trailer weight range-lb. (kg) (0-Maximum)
4.0L SOHC	3.55	7700 (3493)	0-3240 (0-1470)
4.6L* Class II towing	3.55	7700 (3493)	0-3260 (0-1479)
4.0L SOHC Class III/IV towing	3.73 LS	10240 (4645)	0-5760 (0-2613)
4.6L* Class III/IV towing	3.73/3.73 LS	11600 (5262)	0-7140 (0-3239)

Tires, Wheels and Loading

4x2			
GCWR (Gross Combined Weight Rating)/Trailer Weight			
Engine	Rear axle ratio	Maximum GCWR-lb. (kg)	Trailer weight range-lb. (kg) (0-Maximum)
<p>Notes: - For high altitude operation, reduce GCW by 2% per 1,000 ft. (300 meters) elevation. For definitions of terms used in this table and instructions on how to calculate your vehicle load, refer to <i>Vehicle loading</i> in this chapter. Maximum trailer weights shown. The combined weight of the completed towing vehicle and the loaded trailer must not exceed the GCWR.</p>			
<p>*-When towing maximum loads under high outside temperatures and on steep grades, the A/C system may cycle on and off to protect the engine from overheating. This may result in a temporary increase of interior temperatures.</p>			
<p>Towing a trailer over 3,500 lb. (1,588 kg) requires a weight distributing hitch.</p>			
4x4/AWD			
GCWR (Gross Combined Weight Rating)/Trailer Weight			
Engine	Rear axle ratio	Maximum GCWR-lb. (kg)	Trailer weight range-lb. (kg) (0-Maximum)
4.0L SOHC Class II towing	3.55	8000 (3629)	0-3380 (0-1533)
4.6L* Class II towing	3.55	8000 (3629)	0-3400 (0-1542)
4.0L SOHC Class III/IV towing	3.73 LS	10000 (4536)	0-5380 (0-2440)
4.6L* Class III/IV towing	3.73/3.73 LS	11600 (5262)	0-7000 (0-3175)

Tires, Wheels and Loading

4x4/AWD

Notes: - For high altitude operation, reduce GCW by 2% per 1,000 ft. (300 meters) elevation. For definitions of terms used in this table and instructions on how to calculate your vehicle load, refer to *Vehicle loading* in this chapter. Maximum trailer weights shown. The combined weight of the completed towing vehicle and the loaded trailer must not exceed the GCWR

*-When towing maximum loads under high outside temperatures and/or on steep grades, the A/C system may cycle on and off to protect the engine from overheating. This may result in a temporary increase of interior temperatures.

Towing a trailer over 3,500 ft. (1588 kg) requires a weight distributing hitch.

Preparing to tow

Use the proper equipment for towing a trailer and make sure it is properly attached to your vehicle. See your dealer or a reliable trailer dealer if you require assistance.

Hitches

Do not use hitches that clamp onto the vehicle bumper. Use a load carrying hitch. You must distribute the load in your trailer so that 10–15% of the total weight of the trailer is on the tongue, not to exceed the maximum tongue loads as stated:

- Class II receiver: 350 lb. (159 kg)
- Class III/IV receiver: 500 lb. (227 kg) (weight carrying); 770 lb. (349 kg) (weight distributing)

Safety chains

Always connect the trailer's safety chains to the frame or hook retainers of the vehicle hitch. To connect the trailer's safety chains, cross the chains under the trailer tongue and allow slack for turning corners.

If you use a rental trailer, follow the instructions that the rental agency gives to you.

Do not attach safety chains to the bumper.

Trailer brakes

Electric brakes and manual, automatic or surge-type trailer brakes are safe if installed properly and adjusted to the manufacturer's specifications. The trailer brakes must meet local and Federal regulations.

Tires, Wheels and Loading



Do not connect a trailer's hydraulic brake system directly to your vehicle's brake system. Your vehicle may not have enough braking power and your chances of having a collision greatly increase.

The braking system of the tow vehicle is rated for operation at the GVWR not GCWR.

Trailer lamps

Trailer lamps are required on most towed vehicles. Make sure all running lights, brake lights, turn signals and hazard lights are working. See your dealer or trailer rental agency for proper instructions and equipment for hooking up trailer lamps.



Never connect any trailer lighting to the vehicle's taillamp circuits, because it may damage the electrical system resulting in fire. Contact your local Ford dealership for assistance in proper trailer tow wiring installation. Additional electrical equipment may be required.

Driving while you tow

When towing a trailer:

- Turn off the speed control. The speed control may shut off automatically when you are towing on long, steep grades.
- Consult your local motor vehicle speed regulations for towing a trailer.
- To eliminate excessive shifting, use a lower gear. This will also assist in transmission cooling. (For additional information, refer to the *Driving with a 5-speed automatic transmission* section in the *Driving* chapter.)
- Under extreme conditions with large frontal trailers, high outside temperatures and highway speeds, the coolant gauge may indicate higher than normal coolant temperatures. If this occurs, reduce speed until the coolant temperature returns to the normal range. Refer to *Engine coolant temperature gauge* in the *Instrument Cluster* chapter.
- Anticipate stops and brake gradually.
- Do not exceed the GCWR rating or transmission damage may occur.

Servicing after towing

If you tow a trailer for long distances, your vehicle will require more frequent service intervals. Refer to your *Scheduled Maintenance Information* for more information.

Tires, Wheels and Loading

Trailer towing tips

- Practice turning, stopping and backing up before starting on a trip to get the feel of the vehicle trailer combination. When turning, make wider turns so the trailer wheels will clear curbs and other obstacles.
- Allow more distance for stopping with a trailer attached.
- If you are driving down a long or steep hill, shift to a lower gear. Do not apply the brakes continuously, as they may overheat and become less effective.
- The trailer tongue weight should be 10–15% of the loaded trailer weight.
- After you have traveled 50 miles (80 km), thoroughly check your hitch, electrical connections and trailer wheel lug nuts.
- To aid in engine/transmission cooling and A/C efficiency during hot weather while stopped in traffic, place the gearshift lever in P (Park).
- Vehicles with trailers should not be parked on a grade. If you must park on a grade, place wheel chocks under the trailer's wheels.

Launching or retrieving a boat

Disconnect the wiring to the trailer before backing the trailer into the water. Reconnect the wiring to the trailer after the trailer is removed from the water.

When backing down a ramp during boat launching or retrieval:

- do not allow the static water level to rise above the bottom edge of the rear bumper.
- do not allow waves to break higher than 6 inches (15 cm) above the bottom edge of the rear bumper.

Exceeding these limits may allow water to enter vehicle components:

- causing internal damage to the components.
- affecting driveability, emissions and reliability.

Replace the rear axle lubricant any time the axle has been submerged in water. Rear axle lubricant quantities are not to be checked or changed unless a leak is suspected or repair required.

RECREATIONAL TOWING (ALL WHEELS ON THE GROUND)

Follow these guidelines for your specific powertrain combination to tow your vehicle with all four wheels on the ground (such as behind a recreational vehicle).

Tires, Wheels and Loading

These guidelines are designed to ensure that your transmission is not damaged due to insufficient lubrication.

Rear Wheel Drive (RWD) 4x2 vehicles:

This applies to all 4x2 trucks/sport utilities with rear wheel drive capability.

- Place the transmission in N (Neutral).
- Maximum speed is 35 mph (56 km/h).
- Maximum distance is 50 miles (80 km).

If a distance of 50 miles (80 km) or a speed of 35 mph (56 km/h) must be exceeded, you must disconnect the driveshaft. Ford recommends the driveshaft be removed/installed only by a qualified technician. See your local dealer for driveshaft removal/installation.

Improper removal/installation of the driveshaft can cause transmission fluid loss, damage to the driveshaft and internal transmission components.

4x4 vehicles with electronic shift transfer case (Neutral tow kit accessory):

On vehicles equipped with 4WD, an accessory is available that allows you to tow your vehicle, behind another vehicle, with all the wheels on the ground. Contact your dealer for more details. Do not tow your vehicle with all wheels on the ground unless you install the neutral tow kit as vehicle damage may occur.

AWD vehicles:

Vehicles equipped with AWD cannot be towed with any wheels on the ground as vehicle damage may occur.

Driving

STARTING

Positions of the ignition

1. OFF/LOCK, shuts off the engine and all accessories/locks the steering wheel, gearshift lever and allows key removal.
2. ACC, allows the electrical accessories such as the radio to operate while the engine is not running. This position also unlocks the steering wheel.
3. ON, all electrical circuits operational. Warning lights illuminated. Key position when driving.
4. START, cranks the engine. Release the key as soon as the engine starts.

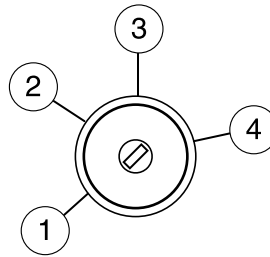

Important safety precautions

When the engine starts, the idle RPM runs faster to warm the engine. If the engine idle speed does not slow down automatically, have the vehicle checked.

Before starting the vehicle:

1. Make sure all occupants buckle their safety belts. For more information on safety belts and their proper usage, refer to the *Seating and Safety Restraints* chapter.
 2. Make sure the headlamps and electrical accessories are off.
- Make sure the parking brake is set.

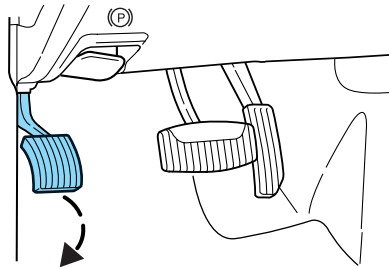

Driving

- Make sure the gearshift is in P (Park).

3. Turn the key to 3 (ON) without turning the key to 4 (START).

P RND321

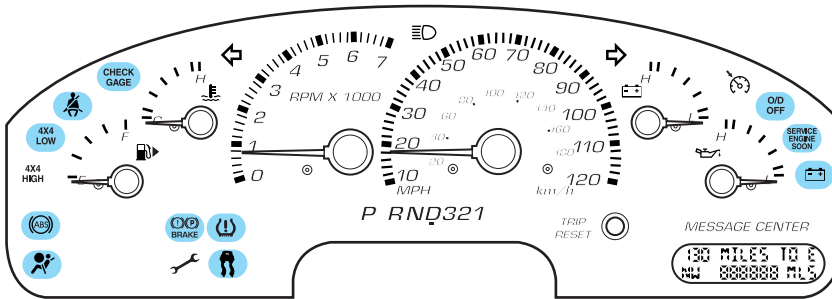
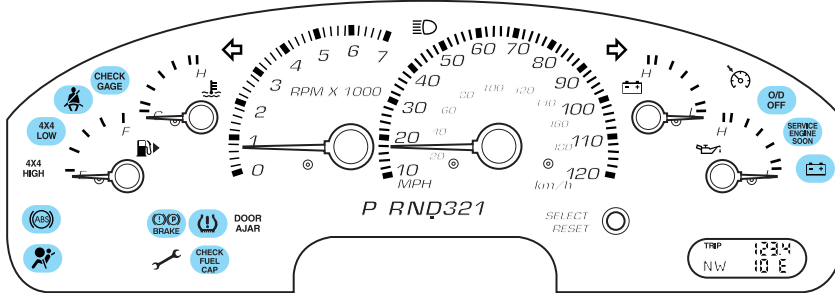
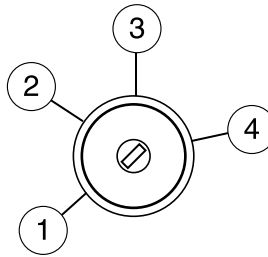

Make sure the corresponding lights illuminate or illuminate briefly. If a light fails to illuminate, have the vehicle serviced.

- If the driver's safety belt is fastened, the  light may not illuminate.

Driving

Starting the engine

1. Turn the key to 3 (ON) without turning the key to 4 (START). If there is difficulty in turning the key, rotate the steering wheel until the key turns freely. This condition may occur when:

- the front wheels are turned
- a front wheel is against the curb

2. Turn the key to 4 (START), then release the key as soon as the engine starts. Excessive cranking could damage the starter.

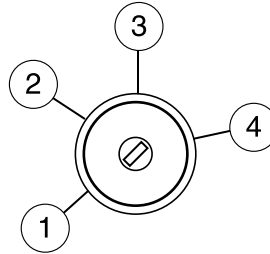

Note: If the engine does not start within five seconds on the first try, turn the key to OFF, wait 10 seconds and try again. If the engine still fails to start, press the accelerator to the floor and try again; this will allow the engine to crank with the fuel shut off in case the engine is flooded with fuel.

Cold weather starting (flexible fuel vehicles only)

As the outside temperature approaches freezing, ethanol fuel distributors should supply winter grade ethanol (same as with unleaded gasoline). If summer grade ethanol is used in cold weather conditions, you may experience increased cranking times, rough idle or hesitation until the engine has warmed up. Consult your fuel distributor for the availability of winter grade ethanol.

Do not crank the engine for more than 30 seconds at a time as starter damage may occur. If the engine fails to start, turn the key to OFF and wait 30 seconds before trying again.

Do not use starting fluid such as ether in the air intake system. Such fluid could cause immediate explosive damage to the engine and possible personal injury.

If you should experience cold weather starting problems on E₈₅ ethanol, and neither an alternative brand of E₈₅ ethanol nor an engine block heater is available, the addition of unleaded gasoline to your tank will improve cold starting performance. Your vehicle is designed to operate on E₈₅ ethanol alone, unleaded gasoline alone, or any mixture of the two.

See *Choosing the right fuel* in the *Maintenance and Specifications* chapter for more information on ethanol.

202

2005 Explorer (exp)
Owners Guide (post-2002-fmt)
USA (fus)

Driving

If the engine fails to start using the preceding instructions (flexible fuel vehicles only)

1. Press and hold down the accelerator 1/3 to 1/2 way to floor, then crank the engine.
2. When the engine starts, release the key, then gradually release the accelerator pedal as the engine speeds up. If the engine still fails to start, repeat Step 1.

Using the engine block heater (if equipped)

An engine block heater warms the engine coolant which aids in starting and heater/defroster performance. Use of an engine block heater is strongly recommended if you live in a region where temperatures reach -10°F (-23°C) or below. For best results, plug the heater in at least three hours before starting the vehicle. The heater can be plugged in the night before starting the vehicle.



To reduce the risk of electrical shock, do not use your heater with ungrounded electrical systems or two-pronged (cheater) adapters.

Guarding against exhaust fumes

Carbon monoxide is present in exhaust fumes. Take precautions to avoid its dangerous effects.



If you smell exhaust fumes inside your vehicle, have your dealer inspect your vehicle immediately. Do not drive if you smell exhaust fumes.

Important ventilating information

If the engine is idling while the vehicle is stopped for a long period of time, open the windows at least one inch (2.5 cm) or adjust the heating or air conditioning to bring in fresh air.

BRAKES

Occasional brake noise is normal. If a metal-to-metal, continuous grinding or continuous squeal sound is present, the brake linings may be worn-out and should be inspected by a qualified service technician. If the vehicle has continuous vibration or shudder in the steering wheel while braking, the vehicle should be inspected by a qualified service technician.

Driving

Refer to *Brake system warning light* in the *Instrument Cluster* chapter for information on the brake system warning light.



Four-wheel anti-lock brake system (ABS)

Your vehicle is equipped with an Anti-lock Braking System (ABS). This system helps you maintain steering control during emergency stops by keeping the brakes from locking. Noise from the ABS pump motor and brake pedal pulsation may be observed during ABS braking and the brake pedal may suddenly travel a little farther as soon as ABS braking is done and normal brake operation resumes. These are normal characteristics of the ABS and should be no reason for concern.

ABS warning lamp

The ABS lamp in the instrument cluster momentarily illuminates when the ignition is turned on. If the light does not illuminate during start up, remains on or flashes, the ABS may be disabled and may need to be serviced.



Even when the ABS is disabled, normal braking is still effective. (If your BRAKE warning lamp illuminates with the parking brake released, have your brake system serviced immediately.)

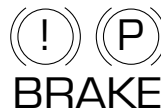

Brake Assist (if equipped as part of the AdvanceTrac® system)

The Brake Assist system provides full braking force during panic braking situations. It detects a rapid application of the brake pedal and maximizes the amount of brake booster assist, helping the driver to achieve maximum braking pressure. Once a panic brake application is detected, the system will remain activated as long as the brake pedal is depressed. The system is deactivated by releasing the brake pedal.

When the system activates, the brake pedal will travel with very little effort; this is normal.

Parking brake

Apply the parking brake whenever the vehicle is parked. To set the parking brake, press the parking brake pedal down until the pedal stops.

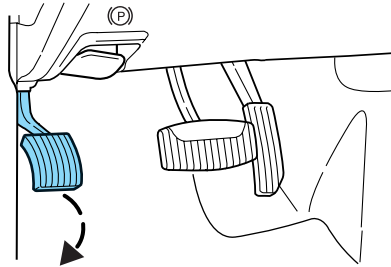

The BRAKE warning lamp in the instrument cluster illuminates and remains illuminated (when the ignition is turned ON) until the parking brake is released.



Always set the parking brake fully and make sure that the gearshift is securely latched in P (Park).



If the parking brake is fully released, but the brake warning lamp remains illuminated, the brakes may not be working properly. See your dealer or a qualified service technician.

The parking brake is not recommended to stop a moving vehicle. However, if the normal brakes fail, the parking brake can be used to stop your vehicle in an emergency. Since the parking brake applies only the rear brakes, the vehicle's stopping distance will increase greatly and the handling of your vehicle will be adversely affected.

Driving

Pull the release lever to release the brake. Driving with the parking brake on will cause the brakes to wear out quickly and reduce fuel economy.

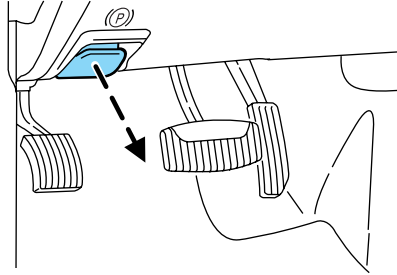

ADVANCETRAC® WITH ROLL STABILITY CONTROL (RSC) STABILITY ENHANCEMENT SYSTEM (IF EQUIPPED)

The AdvanceTrac® system provides a stability enhancement feature as well as a traction enhancement feature. It helps your vehicle maintain traction, when driving on slippery and/or hilly road surfaces, by detecting and controlling wheel spin. Excessive wheel spin is controlled by momentarily reducing engine power and rapidly applying the anti-lock brakes. The system is a driver aid which makes your vehicle easier to handle primarily on snow and ice-covered roads.

If your vehicle should become stuck in deep snow or mud, try switching the AdvanceTrac® system off by pressing the AdvanceTrac® button. This will allow your tires to “dig” for traction.

If the AdvanceTrac® system is activated excessively in a short period of time, the brake portion of the system will shut down to allow the brakes to cool down. A limited AdvanceTrac® function using only engine power reduction will still help control the wheels from over-spinning. When the brakes have cooled down, the system will again function normally. Anti-lock braking is not affected by this condition and will function normally during the cool-down period.

AdvanceTrac® enhances your vehicle’s stability during maneuvers that require all available tire traction, like in wet/snowy/icy road conditions and/or when performing emergency maneuvers. In an emergency lane-change, the driver will experience better overall vehicle traction, and have better control of the vehicle.

The AdvanceTrac® system helps the driver maintain steering control if the vehicle begins to slide excessively left or right or spin out. AdvanceTrac® will attempt to correct the sliding motion by applying brake force at individual tires and, if necessary, by reducing engine power.

206

*2005 Explorer (exp)
Owners Guide (post-2002-fmt)
USA (fus)*

Driving conditions which may activate AdvanceTrac® include:

- Taking a turn too fast.
- Maneuvering quickly to avoid an accident, pedestrian or obstacle.
- Hitting a patch of ice.
- Changing lanes on a snow-rutted road.
- Entering a snow-free road from a snow-covered side street, or vice versa.
- Entering a paved road from a gravel road, or vice versa.
- Driving on slick surfaces.
- Cornering while towing a heavily loaded trailer (refer to *Trailer towing* in the *Tires, Wheels and Loading* chapter.)

Roll Stability Control System (if equipped)

The Roll Stability Control system works in conjunction with the AdvanceTrac® system to further enhance the vehicle's overall stability during aggressive maneuvers. The system helps maintain roll stability of the vehicle during aggressive maneuvers by applying brake force to one or more wheels.

Driving conditions that may activate Roll Stability Control include:

- Emergency lane-change
- Taking a turn too fast
- Quick maneuvering to avoid an accident, pedestrian or obstacle

The AdvanceTrac®/Roll Stability Control system automatically turns on when the engine is started. However, the system does not function when the vehicle is traveling in R (Reverse). In R (Reverse), ABS and the traction enhancement feature will continue to function.

The AdvanceTrac®/Roll Stability Control button allows the driver to control the availability of the AdvanceTrac®/Roll Stability Control system. AdvanceTrac®/Roll Stability



Control system status is indicated by a warning indicator light with a "sliding car" icon in the instrument cluster that will flash when the system is active and an indicator light in the control button that will illuminate when the system is turned off. In vehicles with a message center, the message "ADVANCETRAC OFF" will be displayed.

If a failure is detected in the AdvanceTrac®/Roll Stability Control system, the warning indicator light in the instrument cluster will stay on. If the

Driving

warning indicator light in the instrument cluster remains on while the engine is running, have the system serviced immediately.

Pressing the control once will disable the AdvanceTrac® stability enhancement/Roll Stability Control and the engine power reduction portion of the traction enhancement feature; the brake portion of the traction enhancement feature will still function normally. Pressing and holding the control for more than five seconds will disable the AdvanceTrac® stability enhancement/Roll Stability Control and traction enhancement feature. If the vehicle is stuck in snow or mud or when driving in deep sand, switching off the AdvanceTrac® system may be beneficial so the wheels are allowed to spin. If your vehicle seems to lose engine power while driving in deep sand or very deep snow, switching off the AdvanceTrac® stability enhancement feature will restore full engine power and will enhance momentum through the obstacle.

Some drivers may notice a slight movement of the brake pedal when the AdvanceTrac® performs a system self-check. During AdvanceTrac®/Roll Stability Control operation you may experience the following:

- A rumble or grinding noise
- A slight deceleration of the vehicle
- The AdvanceTrac® indicator light will flash
- If your foot is on the brake pedal, you will feel a vibration in the pedal.
- If the driving condition is severe and your foot is not on the brake, the brake pedal will move to apply higher brake forces. You may also hear a whoosh of air from under the instrument panel during this severe condition.

All these conditions are normal during AdvanceTrac®/Roll Stability Control operation.

Do not alter or modify your vehicle's suspension or steering; the resulting changes to the vehicle's handling can adversely affect the AdvanceTrac®/Roll Stability Control system.

Note: Pressing the AdvanceTrac® button will disable AdvanceTrac® and Roll Stability Control.



Aggressive driving in any road conditions can cause you to lose control of your vehicle increasing the risk of severe personal injury or property damage. The occurrence of a AdvanceTrac®/Roll Stability Control event is an indication that at least some of the tires have exceeded their ability to grip the road; this may lead to an increased risk of loss of vehicle control, vehicle rollover, personal injury and death. If you experience a severe road event, SLOW DOWN.

STEERING

To prevent damage to the power steering system:

- Never hold the steering wheel at its furthest turning points (until it stops) for more than a few seconds when the engine is running.
- Do not operate the vehicle with a low power steering pump reservoir fluid level (below the MIN mark on the reservoir).

If the power steering system breaks down (or if the engine is turned off), you can steer the vehicle manually, but it takes more effort.

If the steering wanders or pulls, check for:

- an improperly inflated tire
- uneven tire wear
- loose or worn suspension components
- loose or worn steering components
- improper steering alignment

A high crown in the road or high crosswinds may also make the steering seem to wander/pull.

PREPARING TO DRIVE YOUR VEHICLE



Utility vehicles have a significantly higher rollover rate than other types of vehicles.



In a rollover crash, an unbelted person is significantly more likely to die than a person wearing a safety belt.

Your vehicle has larger tires and increased ground clearance, giving the vehicle a higher center of gravity than a passenger car.



Vehicles with a higher center of gravity such as utility and four-wheel drive vehicles handle differently than vehicles with a lower center of gravity. Utility and four-wheel drive vehicles are **not** designed for cornering at speeds as high as passenger cars any more than low-slung sports cars are designed to perform satisfactorily under off-road conditions. Avoid sharp turns, excessive speed and abrupt maneuvers in these vehicles. Failure to drive cautiously could result in an increased risk of loss of vehicle control, vehicle rollover, personal injury and death.

Driving

 Loaded vehicles, with a higher center of gravity, may handle differently than unloaded vehicles. Extra precautions such as slower speeds and increased stopping distance should be taken when driving a heavily loaded vehicle.

AUTOMATIC TRANSMISSION OPERATION

Brake-shift interlock

This vehicle is equipped with a brake-shift interlock feature that prevents the gearshift lever from being moved from P (Park) when the ignition is in the ON position unless brake pedal is depressed.

If you cannot move the gearshift lever out of P (Park) with ignition in the ON position and the brake pedal depressed:

1. Apply the parking brake, turn ignition key to LOCK, then remove the key.
2. Locate the access plug to the brake-shift interlock override. It is located on the underside of the steering column.

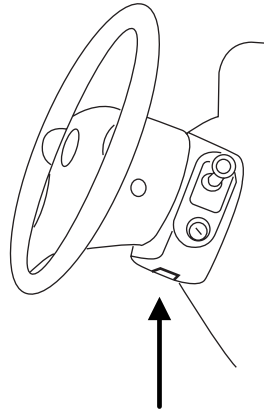

Driving

3. Remove the access plug with a flat head screwdriver (or similar tool).

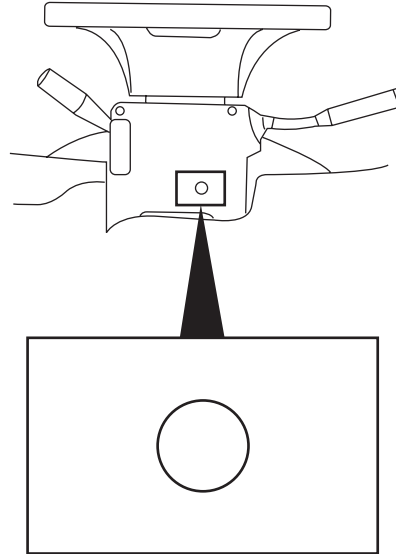

4. Insert a tool (or screwdriver) into the access hole to override the brake-shift interlock. Apply the brake and shift into Neutral.

5. Return the cover plug to the access hole. Start the vehicle.

If it is necessary to use the above procedure to move the gearshift lever, it is possible that a fuse has blown or the vehicle's brakelamps are not operating properly. Refer to *Fuses and relays* in the *Roadside Emergencies* chapter.



Do not drive your vehicle until you verify that the brakelamps are working.



Always set the parking brake fully and make sure the gearshift is latched in P (Park). Turn the ignition to the LOCK position and remove the key whenever you leave your vehicle.



If the parking brake is fully released, but the brake warning lamp remains illuminated, the brakes may not be working properly. See your dealer or a qualified service technician.

Driving

Driving with a 5-speed automatic transmission

P RND321

This vehicle is equipped with an adaptive Transmission Shift Strategy. Adaptive Shift Strategy offers the optimal transmission operation and shift quality. When the vehicle's battery has been disconnected for any type of service or repair, the transmission will need to relearn the normal shift strategy parameters, much like having to reset your radio stations when your vehicle battery has been disconnected. The Adaptive Transmission Strategy allows the transmission to relearn these operating parameters. This learning process could take several transmission upshifts and downshifts; during this learning process, slightly firmer shifts may occur. After this learning process, normal shift feel and shift scheduling will resume.

P (Park)

This position locks the transmission and prevents the rear wheels from turning.

To put your vehicle in gear:

- Start the engine
- Depress the brake pedal
- Move the gearshift lever into the desired gear

To put your vehicle in P (Park):

- Come to a complete stop
- Move the gearshift lever and securely latch it in P (Park)



Always set the parking brake fully and make sure the gearshift is latched in P (Park). Turn the ignition to the LOCK position and remove the key whenever you leave your vehicle.

R (Reverse)

With the gearshift lever in R (Reverse), the vehicle will move backward. Always come to a complete stop before shifting into and out of R (Reverse).

N (Neutral)

With the gearshift lever in N (Neutral), the vehicle can be started and is free to roll. Hold the brake pedal down while in this position.

212

D (Drive) with Overdrive

The normal driving position for the best fuel economy. Transmission operates in gears one through five.

D (Drive) without Overdrive

Overdrive can be deactivated by pressing the transmission control switch on the end of the gearshift lever.

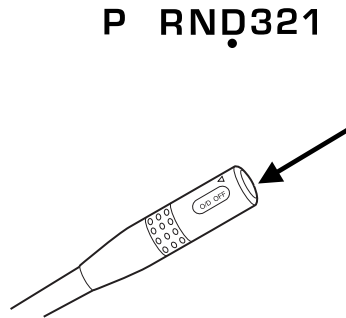

- This position allows for all forward gears except overdrive.
- O/D OFF lamp is illuminated.

**O/D
OFF**

- Provides engine braking.
- Use when driving conditions cause excessive shifting from O/D to other gears. Examples: city traffic, hilly terrain, heavy loads, trailer towing and when engine braking is required.
- To return to O/D (overdrive mode), press the transmission control switch. The O/D OFF lamp will not be illuminated.
- O/D (Overdrive) is automatically returned each time the key is turned off.

3 (Third)

Transmission operates in third gear only.

Used for improved traction on slippery roads. Selecting 3 (Third) provides engine braking.

2 (Second)

Use 2 (Second) to start-up on slippery roads or to provide additional engine braking on downgrades.

1 (First)

- Provides maximum engine braking.
- Allows upshifts by moving gearshift lever.
- Will not downshift into 1 (First) at high speeds; allows for 1 (First) when vehicle reaches slower speeds.

Driving

Forced downshifts

- Allowed in D (Overdrive) or Drive.
- Depress the accelerator to the floor.
- Allows transmission to select an appropriate gear.

If your vehicle gets stuck in mud or snow

If your vehicle gets stuck in mud or snow, it may be rocked out by shifting between forward and reverse gears, stopping between shifts in a steady pattern. Press lightly on the accelerator in each gear.

Do not rock the vehicle if the engine is not at normal operating temperature or damage to the transmission may occur.

Do not rock the vehicle for more than a minute or damage to the transmission and tires may occur, or the engine may overheat.

REVERSE SENSING SYSTEM (IF EQUIPPED)

The Reverse Sensing System (RSS) sounds a tone to warn the driver of obstacles near the rear bumper when the R (Reverse) is selected and the vehicle is moving at speeds less than 3 mph (5 km/h). The system is not effective at speeds above 3 mph (5 km/h) and may not detect certain angular or moving objects.



To help avoid personal injury, please read and understand the limitations of the reverse sensing system as contained in this section. Reverse sensing is only an aid for some (generally large and fixed) objects when moving in reverse on a flat surface at “parking speeds”. Inclement weather may also affect the function of the RSS; this may include reduced performance or a false activation.



To help avoid personal injury, always use caution when in R (Reverse) and when using the RSS.



This system is not designed to prevent contact with small or moving objects. The system is designed to provide a warning to assist the driver in detecting large stationary objects to avoid damaging the vehicle. The system may not detect smaller objects, particularly those close to the ground.

Driving

 Certain add-on devices such as large trailer hitches, bike or surfboard racks and any device that may block the normal detection zone of the RSS system may create false beeps.

The RSS detects obstacles up to six feet (two meters) from the rear bumper with a decreased coverage area at the outer corners of the bumper, (refer to the figures for approximate zone coverage areas). As you move closer to the obstacle, the rate of the tone increases. When the obstacle is less than 10 inches (25.0 cm) away, the tone will sound continuously. If the RSS detects a stationary or receding object further than 10 inches (25.0 cm) from the side of the vehicle, the tone will sound for only three seconds. Once the system detects an object approaching, the tone will sound again.

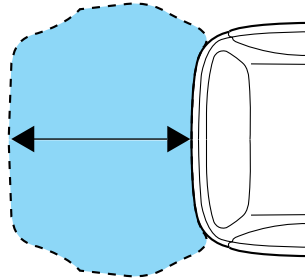
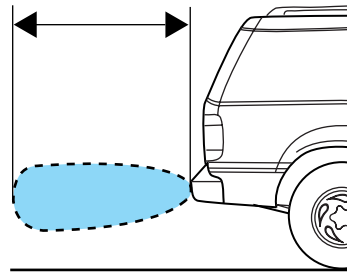

The RSS automatically turns on when the gear selector is placed in R (Reverse) and the ignition is ON. An RSS control on the instrument panel allows the driver to turn the RSS on and off. To turn the RSS off, the ignition must be ON, and the gear selector in R (Reverse). An indicator light on the control will illuminate when the system is turned off. If the indicator light illuminates when the RSS is not turned off, it may indicate a failure in the RSS.



Keep the RSS sensors (located on the rear bumper/fascia) free from snow, ice and large accumulations of dirt (do not clean the sensors with sharp objects). If the sensors are covered, it will affect the accuracy of the RSS.

Driving

If your vehicle sustains damage to the rear bumper/fascia, leaving it misaligned or bent, the sensing zone may be altered causing inaccurate measurement of obstacles or false alarms.

LIMITED-SLIP AXLE (IF EQUIPPED)

This axle provides added traction on slippery surfaces, particularly when one wheel is on a poor traction surface. Under normal conditions, the limited slip axle functions like a standard rear axle.

Extended use of other than the manufacturer's specified size tires on a limited slip rear axle could result in a permanent reduction in effectiveness. This loss of effectiveness does not affect normal driving and should not be noticeable to the driver.

FOUR-WHEEL DRIVE (4WD) OPERATION (IF EQUIPPED)



For important information regarding safe operation of this type of vehicle, see **Preparing to drive your vehicle** in this chapter.

Four-wheel drive (4WD) supplies power to all four wheels. 4WD should not be operated on dry pavement; driveline damage may occur.

If equipped with the Electronic Shift 4WD System, and 4WD Low is selected while the vehicle is moving, the 4WD system will not engage. This is normal and should be no reason for concern. Refer to *Shifting to/from 4WD Low* for proper operation.

System indicator lights

- | | |
|---|---------------------|
| • 4X4 HIGH - momentarily illuminates when the vehicle is started. Illuminates when 4H is selected. | 4x4
HIGH |
| • 4X4 LOW – momentarily illuminates when the vehicle is started. Illuminates when 4L is selected. | 4x4
LOW |

Using the Control Trac 4WD system



4X4 AUTO - Power to all four wheels; used for normal street and highway driving.

4X4 HIGH (4WD High) - Used for extra traction such as in snow or icy roads or in off-road situations. Not intended for use on dry pavement.

4X4 LOW (4WD Low) - Uses extra gearing to provide maximum power to all four wheels. Intended only for off-road applications such as deep sand, steep grades or pulling heavy objects. The accelerator pedal is less sensitive than in 4X4 HIGH (4WD High) range. This is to improve vehicle control when operating on very rough terrain. 4X4 LOW (4WD Low) will not engage while the vehicle is moving; this is normal and should be no reason for concern. Refer to *Shifting to/from 4X4 LOW (4WD Low)* for proper operation.

Shifting between 4X4 AUTO (4WD Auto) and 4X4 HIGH (4WD High)

- Select 4X4 AUTO (4WD Auto) or 4X4 HIGH (4WD High) at any forward speed.

Note: Do not perform this operation at speeds above 45 mph (72 km/h) if the outside temperature is below 32°F (0°C).

Note: Do not perform this operation if the rear wheels are slipping.

Shifting to/from 4X4 LOW (4WD Low)

1. Bring the vehicle to a complete stop
2. Depress the brake
3. Place the transmission in N (Neutral).

Driving

4. Press the desired 4WD position.

- If shifting into 4X4 LOW (4WD Low), wait for the 4X4 LOW light in the instrument cluster to turn **on** indicating the shift is complete.
- If shifting out of 4X4 LOW (4WD Low), wait for the 4X4 LOW light in the instrument cluster to turn **off** indicating the shift is complete.

Driving off-road with truck and utility vehicles

4WD vehicles are specially equipped for driving on sand, snow, mud and rough terrain and have operating characteristics that are somewhat different from conventional vehicles, both on and off the road.

How your vehicle differs from other vehicles

Truck and utility vehicles can differ from some other vehicles. Your vehicle may be higher to allow it to travel over rough terrain without getting hung up or damaging underbody components.

The differences that make your vehicle so versatile also make it handle differently than an ordinary passenger car.

Maintain steering wheel control at all times, especially in rough terrain. Since sudden changes in terrain can result in abrupt steering wheel motion, make sure you grip the steering wheel from the outside. Do not grip the spokes.

Drive cautiously to avoid vehicle damage from concealed objects such as rocks and stumps.

You should either know the terrain or examine maps of the area before driving. Map out your route before driving in the area. To maintain steering and braking control of your vehicle, you must have all four wheels on the ground and they must be rolling, not sliding or spinning.

Basic operating principles

- Do not use 4WD High or 4WD Low on dry, hard surfaced roads. Doing so will produce excessive noise, increase tire wear and may damage drive components. 4WD modes are only intended for consistently slippery or loose surfaces.
- Drive slower in strong crosswinds which can affect the normal steering characteristics of your vehicle.
- Be extremely careful when driving on pavement made slippery by loose sand, water, gravel, snow or ice.

If your vehicle goes off the edge of the pavement

- If your vehicle goes off the edge of the pavement, slow down, but avoid severe brake application, ease the vehicle back onto the

Driving

pavement only after reducing your speed. Do not turn the steering wheel too sharply while returning to the road surface.

- It may be safer to stay on the apron or shoulder of the road and slow down gradually before returning to the pavement. You may lose control if you do not slow down or if you turn the steering wheel too sharply or abruptly.
- It often may be less risky to strike small objects, such as highway reflectors, with minor damage to your vehicle rather than attempt a sudden return to the pavement which could cause the vehicle to slide sideways out of control or roll over. Remember, your safety and the safety of others should be your primary concern.



Vehicles with a higher center of gravity such as utility and four-wheel drive vehicles handle differently than vehicles with a lower center of gravity. Utility and four-wheel drive vehicles are **not** designed for cornering at speeds as high as passenger cars any more than low-slung sports cars are designed to perform satisfactorily under off-road conditions. Avoid sharp turns, excessive speed and abrupt maneuvers in these vehicles. Failure to drive cautiously could result in an increased risk of loss of vehicle control, vehicle rollover, personal injury and death.

If your vehicle gets stuck

If your vehicle gets stuck in mud or snow it may be rocked out by shifting between forward and reverse gears, stopping between shifts, in a steady pattern. Press lightly on the accelerator in each gear.

Do not rock the vehicle if the engine is not at normal operating temperature or damage to the transmission may occur.

Do not rock the vehicle for more than a few minutes or damage to the transmission and tires may occur or the engine may overheat.



Do not spin the wheels at over 35 mph (56 km/h). The tires may fail and injure a passenger or bystander.

Emergency maneuvers

- In an unavoidable emergency situation where a sudden sharp turn must be made, remember to avoid “over-driving” your vehicle, i.e., turn the steering wheel only as rapidly and as far as required to avoid the emergency. Excessive steering will result in less vehicle control,

Driving

not more. Additionally, smooth variations of the accelerator and/or brake pedal pressure should be utilized if changes in vehicle speed are called for. Avoid abrupt steering, acceleration or braking which could result in an increased risk of loss of vehicle control, vehicle rollover and/or personal injury. Use all available road surface to return the vehicle to a safe direction of travel.

- In the event of an emergency stop, avoid skidding the tires and do not attempt any sharp steering wheel movements.



Vehicles with a higher center of gravity such as utility and four-wheel drive vehicles handle differently than vehicles with a lower center of gravity. Utility and four-wheel drive vehicles are **not** designed for cornering at speeds as high as passenger cars any more than low-slung sports cars are designed to perform satisfactorily under off-road conditions. Avoid sharp turns, excessive speed and abrupt maneuvers in these vehicles. Failure to drive cautiously could result in an increased risk of loss of vehicle control, vehicle rollover, personal injury and death.

- If the vehicle goes from one type of surface to another (i.e., from concrete to gravel) there will be a change in the way the vehicle responds to a maneuver (steering, acceleration or braking). Again, avoid these abrupt inputs.

Parking

On some 4WD vehicles, when the transfer case is in the N (Neutral) position, the engine and transmission are disconnected from the rest of the driveline. Therefore, the vehicle is free to roll even if the automatic transmission is in P (Park) or the manual transmission is in gear. Do not leave the vehicle unattended with the transfer case in the N (Neutral) position. Always set the parking brake fully and turn off the ignition when leaving the vehicle.



Always set the parking brake fully and make sure the gearshift is latched in P (Park). Turn the ignition to the LOCK position and remove the key whenever you leave your vehicle.



If the parking brake is fully released, but the brake warning lamp remains illuminated, the brakes may not be working properly. See your dealer or a qualified service technician.

4WD Systems

4WD uses all four wheels to power the vehicle. This increases traction, enabling you to drive over terrain and road conditions that a conventional two-wheel drive vehicle cannot.

Power is supplied to all four wheels through a transfer case. On 4WD vehicles, the transfer case allows you to select 4WD when necessary. Information on transfer case operation and shifting procedures can be found in the *Driving* chapter. Information on transfer case maintenance can be found in the *Maintenance and Specifications* chapter. You should become thoroughly familiar with this information before you operate your vehicle.

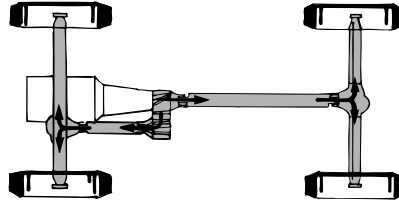

Normal characteristics

On some 4WD models, the initial shift from two-wheel drive to 4x4 while the vehicle is moving can cause some momentary clunk and ratcheting sounds. This is the front drivetrain coming up to speed and the automatic locking hubs engaging and is not cause for concern.

Sand

When driving over sand, try to keep all four wheels on the most solid area of the trail. Avoid reducing the tire pressures but shift to a lower gear and drive steadily through the terrain. Apply the accelerator slowly and avoid spinning the wheels.

If you must reduce the tire pressure for whatever reason in sand, make sure you re-inflate the tires as soon as possible.

Note: If your vehicle is equipped with the Tire Pressure Monitoring System (TPMS), the system indicator light may illuminate depending on how much air is released from your tires and/or how long you drive the vehicle under these conditions.

Avoid excessive speed because vehicle momentum can work against you and cause the vehicle to become stuck to the point that assistance may be required from another vehicle. Remember, you may be able to back out the way you came if you proceed with caution.

Driving

Mud and water

If you must drive through high water, drive slowly. Traction or brake capability may be limited.

When driving through water, determine the depth; avoid water higher than the bottom of the hubs (if possible) and proceed slowly. If the ignition system gets wet, the vehicle may stall.

Once through water, always try the brakes. Wet brakes do not stop the vehicle as effectively as dry brakes. Drying can be improved by moving your vehicle slowly while applying light pressure on the brake pedal.

Be cautious of sudden changes in vehicle speed or direction when you are driving in mud. Even 4WD vehicles can lose traction in slick mud. As when you are driving over sand, apply the accelerator slowly and avoid spinning your wheels. If the vehicle does slide, steer in the direction of the slide until you regain control of the vehicle.

If the transmission, transfer case or front axle are submerged in water, their fluids should be checked and changed, if necessary.

Driving through deep water may damage the transmission.

If the front or rear axle is submerged in water, the axle lubricant should be replaced.

After driving through mud, clean off residue stuck to rotating driveshafts and tires. Excess mud stuck on tires and rotating driveshafts causes an imbalance that could damage drive components.

“Tread Lightly” is an educational program designed to increase public awareness of land-use regulations and responsibilities in our nations wilderness areas. Ford Motor

Company joins the U.S. Forest Service and the Bureau of Land Management in encouraging you to help preserve our national forest and other public and private lands by “treading lightly.”

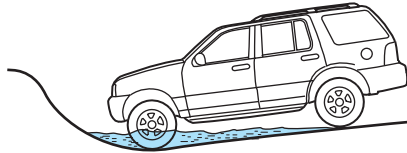

Driving on hilly or sloping terrain

Although natural obstacles may make it necessary to travel diagonally up or down a hill or steep incline, you should always try to drive straight up or straight down. **Avoid driving crosswise or turning on steep slopes or hills.** A danger lies in losing traction, slipping sideways and

Driving

possibly rolling over. Whenever driving on a hill, determine beforehand the route you will use. Do not drive over the crest of a hill without seeing what conditions are on the other side. Do not drive in reverse over a hill without the aid of an observer.

When climbing a steep slope or hill, start in a lower gear rather than downshifting to a lower gear from a higher gear once the ascent has started. This reduces strain on the engine and the possibility of stalling.

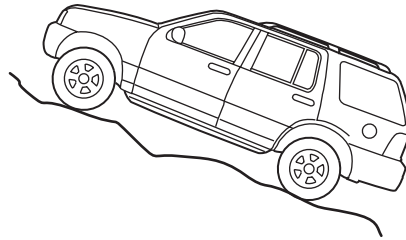

If you do stall out, do not try to turn around because you might roll over. It is better to back down to a safe location.

Apply just enough power to the wheels to climb the hill. Too much power will cause the tires to slip, spin or lose traction, resulting in loss of vehicle control.

Descend a hill in the same gear you would use to climb up the hill to avoid excessive brake application and brake overheating. Do not descend in neutral; instead, disengage overdrive or manually shift to a lower gear. When descending a steep hill, avoid sudden hard braking as you could lose control. When you brake hard, the front wheels can't turn and if they aren't turning, you won't be able to steer. The front wheels have to be turning in order to steer the vehicle. Rapid pumping of the brake pedal will help you slow the vehicle and still maintain steering control.

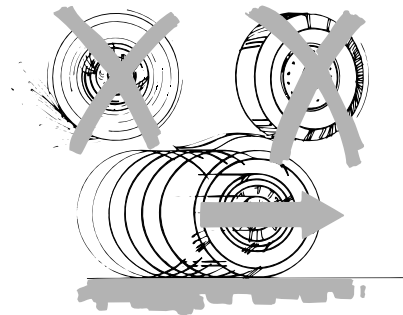

If your vehicle has anti-lock brakes, apply the brakes steadily. Do not “pump” the brakes.

Driving

Driving on snow and ice

4WD vehicles have advantages over 2WD vehicles in snow and ice but can skid like any other vehicle.

Should you start to slide while driving on snowy or icy roads, turn the steering wheel in the direction of the slide until you regain control.

Avoid sudden applications of power and quick changes of direction on snow and ice. Apply the accelerator slowly and steadily when starting from a full stop.

Avoid sudden braking as well. Although a 4WD vehicle may accelerate better than a two-wheel drive vehicle in snow and ice, it won't stop any faster, because as in other vehicles, braking occurs at all four wheels. Do not become overconfident as to road conditions.

Make sure you allow sufficient distance between you and other vehicles for stopping. Drive slower than usual and consider using one of the lower gears. In emergency stopping situations, avoid locking of the wheels. Use a "squeeze" technique, push on the brake pedal with a steadily increasing force which allows the wheels to brake yet continue to roll so that you may steer in the direction you want to travel. If you lock the wheels, release the brake pedal and repeat the squeeze technique. If your vehicle is equipped with a Four Wheel Anti-Lock Brake System (ABS), apply the brake steadily. Do not "pump" the brakes. Refer to the *Brakes* section of this chapter for additional information on the operation of the anti-lock brake system.

Never drive with chains on the front tires of 4WD vehicles without also putting them on the rear tires. This could cause the rear to slide and swing around during braking.

Maintenance and Modifications

The suspension and steering systems on your vehicle have been designed and tested to provide predictable performance whether loaded or empty and durable load carrying capability. For this reason, Ford Motor Company strongly recommends that you do not make modifications such as adding or removing parts (such as lift kits or stabilizer bars) or by using replacement parts not equivalent to the original factory equipment.

Any modifications to a vehicle that raise the center of gravity can make it more likely the vehicle will roll over as a result of a loss of control. Ford Motor Company recommends that caution be used with any vehicle equipped with a high load or device (such as ladder racks or pickup box cover).

224

2005 Explorer (exp)
Owners Guide (post-2002-fmt)
USA (fus)

Driving

Failure to maintain your vehicle properly may void the warranty, increase your repair cost, reduce vehicle performance and operational capabilities and adversely affect driver and passenger safety. Frequent inspection of vehicle chassis components is recommended if the vehicle is subjected to heavy off-road usage.

DRIVING THROUGH WATER

If driving through deep or standing water is unavoidable, proceed very slowly especially when the depth is not known. Never drive through water that is higher than the bottom of the hubs (for trucks) or the bottom of the wheel rims (for cars). When driving through water, traction or brake capability may be limited. Also, water may enter your engine's air intake and severely damage your engine or your vehicle may stall. **Driving through deep water where the transmission vent tube is submerged may allow water into the transmission and cause internal transmission damage.**

Once through the water, always dry the brakes by moving your vehicle slowly while applying light pressure on the brake pedal.

Wet brakes do not stop the vehicle as quickly as dry brakes.

Roadside Emergencies

GETTING ROADSIDE ASSISTANCE

To fully assist you should you have a vehicle concern, Ford Motor Company offers a complimentary roadside assistance program. This program is separate from the New Vehicle Limited Warranty. The service is available:

- 24-hours, seven days a week
- for the New Vehicle Limited Warranty period of three years or 36,000 miles (60,000 km), whichever occurs first on Ford and Mercury vehicles, and four years or 50,000 miles (80,000 km) on Lincoln vehicles.

Roadside assistance will cover:

- a flat tire change with a good spare (except Ford GT which has a tire inflation kit)
- battery jump start
- lock-out assistance (key replacement cost is the customer's responsibility)
- fuel delivery (2.0 gallons [7.5L], maximum two occurrences within 12 month period)
- towing of your disabled vehicle to the nearest Ford Motor Company dealership, or your selling dealer if within 35 miles (56.3 km) of the nearest Ford Motor Company dealership (one tow per disablement). Even non-warranty related tows, like accidents, are covered (some exclusions apply, such as impound towing or repossession).

Canadian customers refer to your Owner Information Guide for information on:

- coverage period
- exact fuel amounts
- towing of your disabled vehicle
- emergency travel expense reimbursement
- travel planning benefits

USING ROADSIDE ASSISTANCE

Complete the roadside assistance identification card and place it in your wallet for quick reference. In the United States, this card is found in the Owner Guide portfolio in the glove compartment. In Canada, the card is found in the *Owner Information Guide* in the glove compartment.

U.S. Ford or Mercury vehicle customers who require roadside assistance, call 1-800-241-3673; Lincoln vehicle customers call 1-800-521-4140.

226

2005 Explorer (exp)
Owners Guide (post-2002-fmt)
USA (fus)

Roadside Emergencies

Canadian customers who require roadside assistance, call 1-800-665-2006.

If you need to arrange roadside assistance for yourself, Ford Motor Company will reimburse a reasonable amount. To obtain reimbursement information, U.S. Ford or Mercury vehicles customers call 1-800-241-3673; Lincoln vehicle customers call 1-800-521-4140.

Canadian customers who need to obtain reimbursement information, call 1-800-665-2006.

ROADSIDE COVERAGE BEYOND BASIC WARRANTY

In the United States, you may purchase additional roadside assistance coverage beyond this period through the Ford Auto Club by contacting your Ford or Lincoln Mercury dealer.

Similarly in Canada, for uninterrupted Roadside Assistance coverage, you may purchase extended coverage prior to your Basic Warranty's Roadside Assistance expiring. For more information and enrollment, contact 1-877-294-2582 or visit our website at www.ford.ca.

HAZARD FLASHER

The hazard flasher is located on the steering column, just behind the steering wheel. The hazard flashers will operate when the ignition is in any position or if the key is not in the ignition.

Push in the flasher control and all front and rear direction signals will flash. Press the flasher control again to turn them off. Use it when your vehicle is disabled and is creating a safety hazard for other motorists.

Note: With extended use, the flasher may run down your battery.

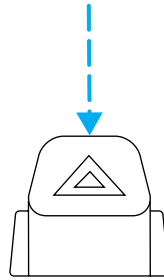

FUEL PUMP SHUT-OFF SWITCH FUEL RESET

The fuel pump shut-off switch is a device intended to stop the electric fuel pump when your vehicle has been involved in a substantial jolt.

After a collision, if the engine cranks but does not start, the fuel pump shut-off switch may have been activated.

Roadside Emergencies

The fuel pump shut-off switch is located in the passenger's foot well, by the kick panel.

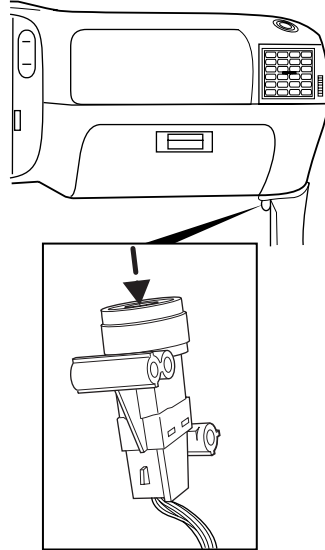

Use the following procedure to reset the fuel pump shut-off switch.

1. Turn the ignition to the OFF position.
2. Check the fuel system for leaks.
3. If no fuel leak is apparent, reset the fuel pump shut-off switch by pushing in on the reset button.
4. Turn the ignition to the ON position. Pause for a few seconds and return the key to the OFF position.
5. Make a further check for leaks in the fuel system.

FUSES AND RELAYS

Fuses

If electrical components in the vehicle are not working, a fuse may have blown. Blown fuses are identified by a broken wire within the fuse. Check the appropriate fuses before replacing any electrical components.

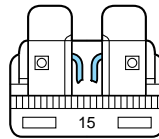

228

2005 Explorer (exp)
Owners Guide (post-2002-fmt)
USA (fus)

Roadside Emergencies

Note: Always replace a fuse with one that has the specified amperage rating. Using a fuse with a higher amperage rating can cause severe wire damage and could start a fire.

Standard fuse amperage rating and color

Fuse rating	COLOR			
	Mini fuses	Standard fuses	Maxi fuses	Cartridge maxi fuses
2A	Grey	Grey	—	—
3A	Violet	Violet	—	—
4A	Pink	Pink	—	—
5A	Tan	Tan	—	—
7.5A	Brown	Brown	—	—
10A	Red	Red	—	—
15A	Blue	Blue	—	—
20A	Yellow	Yellow	Yellow	Blue
25A	Natural	Natural	—	—
30A	Green	Green	Green	Pink
40A	—	—	Orange	Green
50A	—	—	Red	Red
60A	—	—	Blue	Yellow
70A	—	—	Tan	—
80A	—	—	Natural	—

Roadside Emergencies

Passenger compartment fuse panel

The fuse panel is located below the instrument panel on the driver's side.

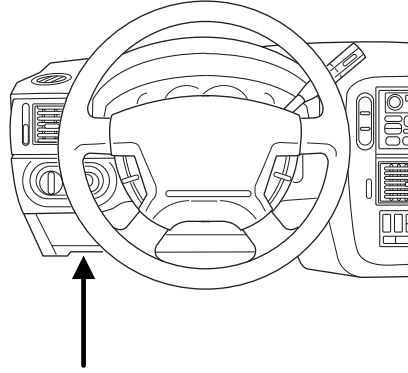

To remove a fuse use the fuse puller tool provided on the fuse panel box.

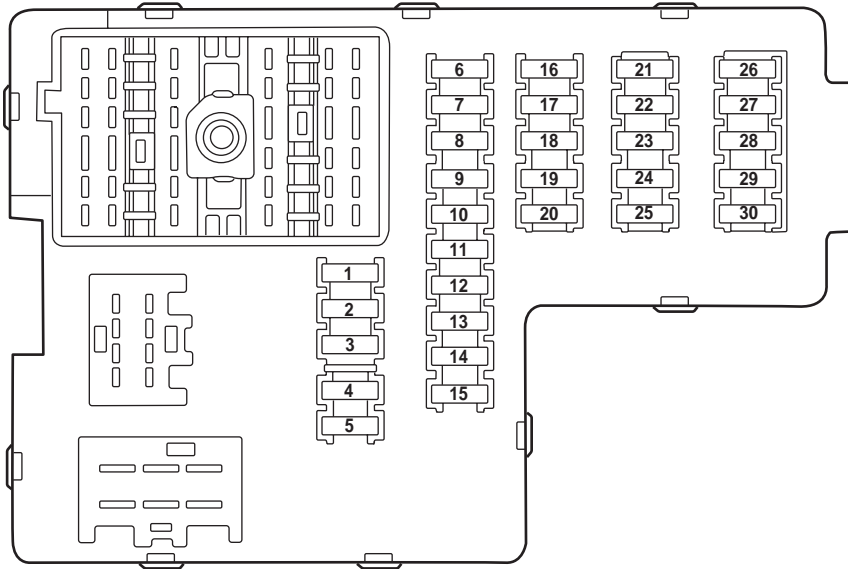

Roadside Emergencies

The fuses are coded as follows:

Fuse/Relay Location	Fuse Amp Rating	Passenger Compartment Fuse Panel Description
1	30A	Memory seat module, Driver power seat, Driver power lumbar
2	20A	Moonroof
3	20A	Radio, Amplifier, DVD
4	5A	Front wiper module
5	15A	Flasher relay (Turn, hazards)
6	10A	Key-in-chime
7	15A	Heated mirrors
8	5A	Heated PCV (4.0L engine only)
9	15A	Not used
10	10A	Heated backlight relay coil, A/C clutch contact
11	20A	Heated seats
12	5A	4x4 (switch)
13	5A	Overdrive cancel switch
14	5A	PATS
15	5A	Rear wiper module, Cluster
16	5A	Power mirror, Manual climate control, TPMS
17	15A	Delayed accessory relay coil/Battery saver coil and contact/Reading and glove box lamps
18	10A	Flexible fuel pump
19	10A	Restraint Control Module (RCM)
20	5A	Memory driver seat switch, Driver seat module, Body Security Module (BSM), PATS LED
21	5A	Instrument cluster, Compass, Flasher coil
22	10A	ABS, IVD Controller

Roadside Emergencies

Fuse/Relay Location	Fuse Amp Rating	Passenger Compartment Fuse Panel Description
23	15A	Not used
24	15A	Cigar lighter, OBD II, Neutral tow
25	5A	Mode-Temperature actuator for auxiliary climate control, Trailer tow battery charge relay coil, TPMS
26	7.5A	Reverse park aid, Brake shift interlock, IVD switch
27	7.5A	Automatic dimming mirror, Digital transmission range sensor, Backup lamps
28	5A	Radio (Start)
29	10A	Digital transmission range sensor, PWR feed to fuse #28 (Start feed)
30	5A	Daytime Running Lamps (DRL), DEATC climate controller, Manual climate control, Manual climate control temp blend actuator

Roadside Emergencies

Passenger compartment fuse panel (top side)

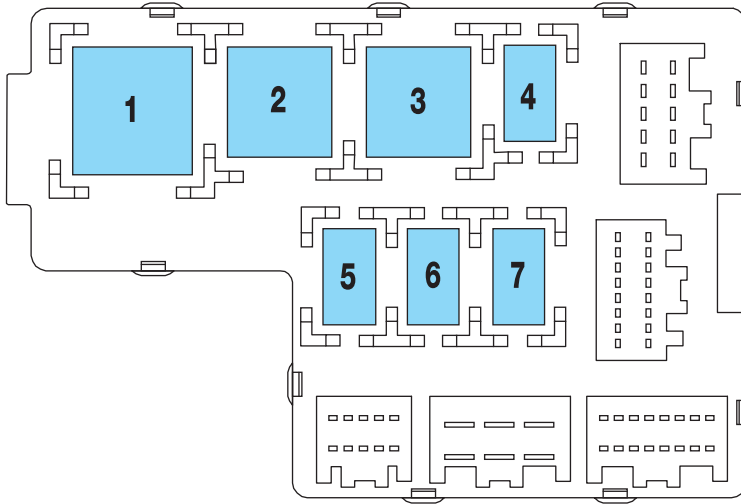

These relays are located on the reverse side of the passenger compartment fuse panel. See your dealer or a certified technician for service of this relay box.

Fuse/Relay Location	Description
Relay 1	Flasher
Relay 2	Rear defrost
Relay 3	Delayed accessory
Relay 4	Open
Relay 5	Battery saver
Relay 6	Open
Relay 7	Open

Roadside Emergencies

Power distribution box

The power distribution box is located in the engine compartment. The power distribution box contains high-current fuses that protect your vehicle's main electrical systems from overloads.

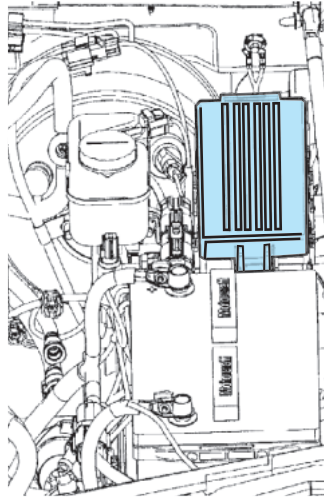

Always disconnect the battery before servicing high current fuses.



To reduce risk of electrical shock, always replace the cover to the Power Distribution Box before reconnecting the battery or refilling fluid reservoirs.

If the battery has been disconnected and reconnected, refer to the *Battery* section of the *Maintenance and Specifications* chapter.

Roadside Emergencies

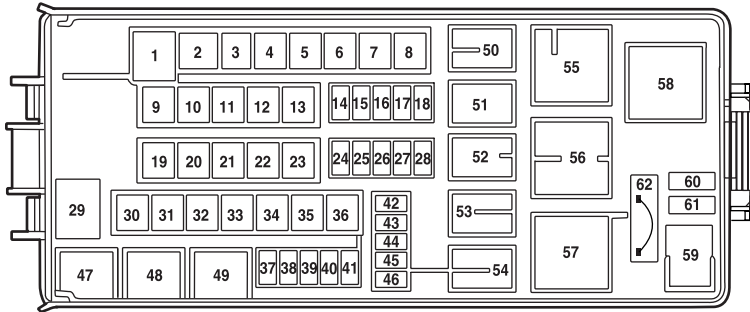

The high-current fuses are coded as follows:

Fuse/Relay Location	Fuse Amp Rating	Power Distribution Box Description
1	60A**	PJB #1
2	30A**	BSM
3	—	Not used
4	30A**	Rear defrost
5	40A**	Anti-lock Brake System (ABS) pump
6	60A**	Delayed accessory, Power windows, Audio
7	20A**	Power point #2
8	30A**	4x4 shift motor
9	20A**	Power point #1
10	30A**	ABS module (valves)
11	40A**	Powertrain Control Module (PCM)
12	50A**	Ignition relay, Starter relay
13	40A**	Trailer tow battery charge, Trailer tow turn signals
14	10A*	Daytime Running Lamps (DRL) (Canada)
15	15A*	Memory (PCM/DEATC/Cluster), Courtesy lamps
16	15A*	Park lamps, Autolamp parklamps, Front foglamps relay coil

Roadside Emergencies

Fuse/Relay Location	Fuse Amp Rating	Power Distribution Box Description
17	5A*	Two-speed 4x4 (relay coils)
18	20A*	PCM with two-speed 4x4 clutch
19	20A**	High beam relay
20	30A**	Trailer electric brake module
21	30A**	Front wiper motor
22	20A**	Low beam, Autolamp
23	30A**	Ignition switch, PCM diode
24	—	Not used
25	15A*	Brake on-off
26	20A*	Fuel pump
27	20A*	Trailer tow park lamps, Trailer tow back-up
28	20A*	Horn relay
29	60A**	PJB #2
30	20A**	Rear wiper motor
31	—	Not used
32	—	Not used
33	30A**	Auxiliary blower motor
34	30A**	Passenger power seat, Adjustable pedals (non-memory)
35	—	Not used
36	40A**	Blower motor
37	15A*	A/C clutch relay, Transmission
38	15A*	HEGO, VMV, CMS, ESM, CVS
39	15A*	Injectors, Fuel pump relay coil
40	15A*	PCM power
41	15A*	Coil on plug (4.6L engine only), Ignition coil (4.0L engine only)
42	10A*	Right low beam
43	10A*	Left low beam
44	15A*	Front foglamps

Roadside Emergencies

Fuse/Relay Location	Fuse Amp Rating	Power Distribution Box Description
45	2A*	Brake pressure switch (non-AdvanceTrac® vehicles)
46	20A*	High beams
47	—	Horn relay
48	—	Fuel pump relay
49	—	High beam relay
50	—	Front foglamps relay
51	—	DRL relay (Canada)
52	—	A/C clutch relay
53	—	Trailer tow right turn relay
54	—	Trailer tow left turn relay
55	—	Blower motor relay
56	—	Starter relay
57	—	PCM relay
58	—	Ignition relay
59	—	Not used
60	—	PCM diode
61	—	A/C clutch diode
62	30A CB	Power windows circuit breaker

* Mini Fuses ** Cartridge Fuses

Rear relay box

The relay box is located on the rear passenger side quarter trim panel. See your dealer or a certified technician for service of this relay box.

Roadside Emergencies

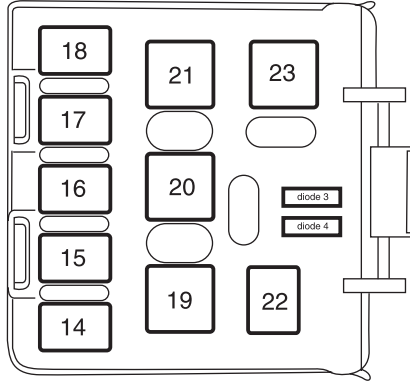

The relays are coded as follows:

Fuse/Relay Location	Description
Relay 14	Not used
Relay 15	Trailer tow back-up lamps
Relay 16	Not used
Relay 17	Not used
Relay 18	Not used
Relay 19	Trailer tow park lamps
Relay 20	Trailer tow battery charge
Relay 21	Not used
Relay 22	Not used
Relay 23	Not used
Diode 3	Not used
Diode 4	Not used

Roadside Emergencies

Auxiliary relay box (Vehicles equipped with 4x4)

The relay box is located on the front right fender well.

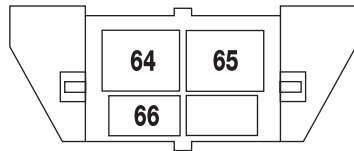
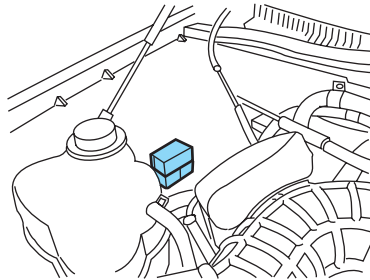

The relays are coded as follows:

Fuse/Relay Location	Description
Relay 64	Two-speed 4x4 motor clockwise
Relay 65	Two-speed 4x4 motor counterclockwise
Relay 66	Open

JUMP STARTING YOUR VEHICLE



The gases around the battery can explode if exposed to flames, sparks, or lit cigarettes. An explosion could result in injury or vehicle damage.



Batteries contain sulfuric acid which can burn skin, eyes and clothing, if contacted.

Do not attempt to push-start your vehicle. Automatic transmissions do not have push-start capability; doing so may damage the catalytic converter.

Roadside Emergencies

Preparing your vehicle

When the battery is disconnected or a new battery is installed, the transmission must relearn its shift strategy. As a result, the transmission may have firm and/or soft shifts. This operation is considered normal and will not affect function or durability of the transmission. Over time, the adaptive learning process will fully update transmission operation.

1. **Use only a 12-volt supply to start your vehicle.**
2. Do not disconnect the battery of the disabled vehicle as this could damage the vehicle's electrical system.
3. Park the booster vehicle close to the hood of the disabled vehicle making sure the two vehicles **do not** touch. Set the parking brake on both vehicles and stay clear of the engine cooling fan and other moving parts.
4. Check all battery terminals and remove any excessive corrosion before you attach the battery cables. Ensure that vent caps are tight and level.
5. Turn the heater fan on in both vehicles to protect any electrical surges. Turn all other accessories off.

Connecting the jumper cables

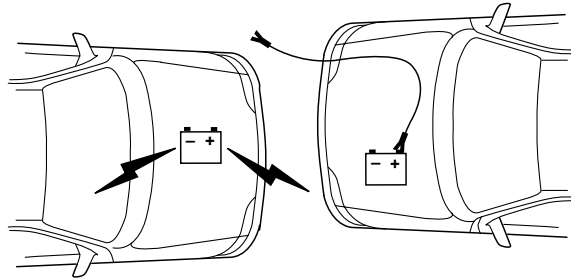

1. Connect the positive (+) jumper cable to the positive (+) terminal of the discharged battery.

Note: In the illustrations, *lightning bolts* are used to designate the assisting (boosting) battery.

Roadside Emergencies

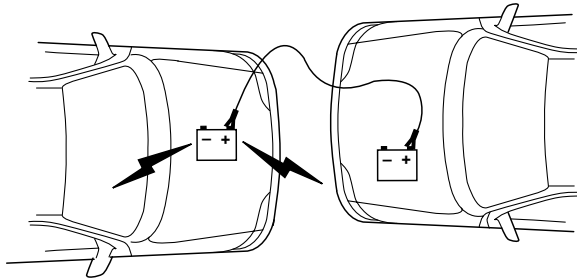

2. Connect the other end of the positive (+) cable to the positive (+) terminal of the assisting battery.

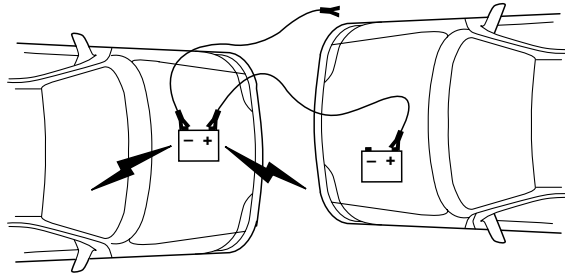

3. Connect the negative (-) cable to the negative (-) terminal of the assisting battery.

Roadside Emergencies

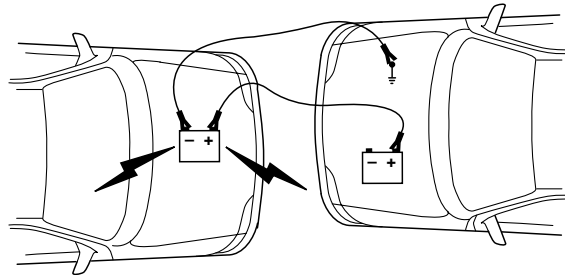

4. Make the final connection of the negative (-) cable to an exposed metal part of the stalled vehicle's engine, away from the battery and the carburetor/fuel injection system. **Do not** use fuel lines, engine rocker covers or the intake manifold as *grounding* points.



Do not connect the end of the second cable to the negative (-) terminal of the battery to be jumped. A spark may cause an explosion of the gases that surround the battery.

5. Ensure that the cables are clear of fan blades, belts, moving parts of both engines, or any fuel delivery system parts.

Jump starting

1. Start the engine of the booster vehicle and run the engine at moderately increased speed.
2. Start the engine of the disabled vehicle.
3. Once the disabled vehicle has been started, run both engines for an additional three minutes before disconnecting the jumper cables.

Removing the jumper cables

Remove the jumper cables in the reverse order that they were connected.

1. Remove the jumper cable from the *ground* metal surface.

Roadside Emergencies

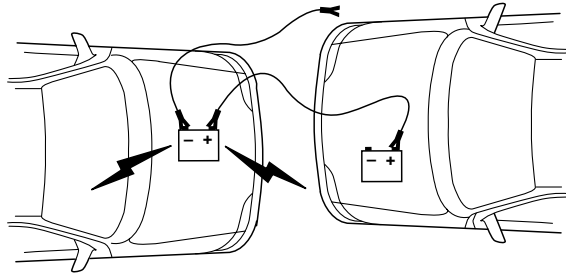

2. Remove the jumper cable on the negative (-) connection of the booster vehicle's battery.

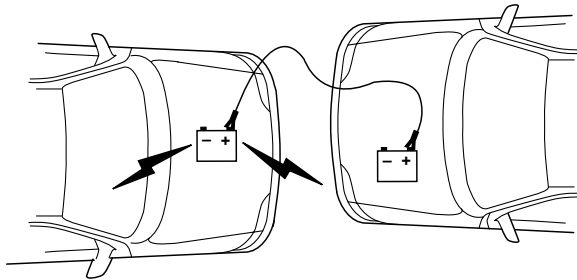

3. Remove the jumper cable from the positive (+) terminal of the booster vehicle's battery.

Roadside Emergencies

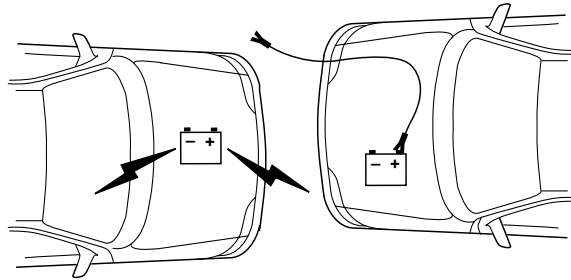

4. Remove the jumper cable from the positive (+) terminal of the disabled vehicle's battery.

After the disabled vehicle has been started and the jumper cables removed, allow it to idle for several minutes so the engine computer can relearn its idle conditions.

Roadside Emergencies

WRECKER TOWING

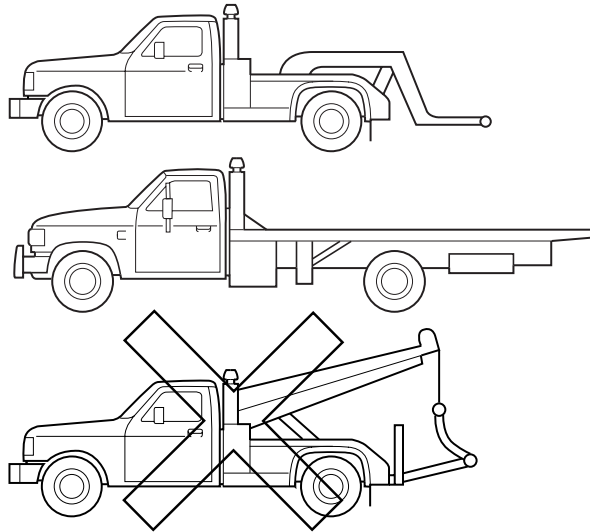

If you need to have your vehicle towed, contact a professional towing service or, if you are a member of a roadside assistance program, your roadside assistance service provider.

It is recommended that your vehicle be towed with a wheel lift or flatbed equipment. Do not tow with a slingbelt. Ford Motor Company has not approved a slingbelt towing procedure.

If the vehicle's battery is discharged, refer to *Automatic transmission operation* in the *Driving* chapter for directions on how to move the gearshift lever out of the P (Park) position, for proper towing.

On 4x2 vehicles, it is acceptable to tow the vehicle with the front wheels on the ground (without dollies) and the rear wheels off the ground.

On 4x4/AWD vehicles, it is recommended that your vehicle be towed with a wheel lift and dollies or flatbed equipment with all the wheels off the ground.

If the vehicle is towed by other means or incorrectly, vehicle damage may occur.

Ford Motor Company produces a towing manual for all authorized tow truck operators. Have your tow truck operator refer to this manual for proper hook-up and towing procedures for your vehicle.

Customer Assistance

GETTING THE SERVICES YOU NEED

At home

You must take your Ford vehicle to an authorized Ford dealer for warranty repairs. While any Ford dealership handling your vehicle line will provide warranty service, we recommend you return to your selling dealer who wants to ensure your continued satisfaction. Please note that certain warranty repairs require special training and/or equipment, so not all dealers are authorized to perform all warranty repairs. This means that, depending on the warranty repair needed, you may have to take your vehicle to another dealer. A reasonable time must be allowed to perform a repair after taking your vehicle to the dealership. Repairs will be made using Ford or Motorcraft parts, or remanufactured or other parts that are authorized by Ford.

If you have questions or concerns, or are unsatisfied with the service you are receiving, follow these steps:

1. Contact your Sales Representative or Service Advisor at your selling/servicing dealership.
2. If your inquiry or concern remains unresolved, contact the Sales Manager, Service Manager or Customer Relations Manager.
3. If you require assistance or clarification on Ford Motor Company policies or procedures, please contact the Ford Customer Relationship Center at 1-800-392-3673 (FORD).

Away from home

If you own a Ford or Mercury vehicle and are away from home when your vehicle needs service, or if you need more help than the dealership could provide, after following the steps described above, contact the Ford Customer Relationship Center to find an authorized dealership to help you.

In the United States:

Ford Motor Company
Customer Relationship Center
P.O. Box 6248
Dearborn, MI 48121
1-800-392-3673 (FORD)
(TDD for the hearing impaired: 1-800-232-5952)
www.customersaskford.com

246

2005 Explorer (exp)
Owners Guide (post-2002-fmt)
USA (fus)

Customer Assistance

In Canada:
Customer Relationship Centre
Ford Motor Company of Canada, Limited
P.O. Box 2000
Oakville, Ontario L6J 5E4
1-800-565-3673 (FORD)
www.ford.ca

If you own a Lincoln vehicle and are away from home when your vehicle needs service, or if you need more help than the dealership could provide, after following the steps described above, contact the Ford Customer Relationship Center to find an authorized dealership to help you.

In the United States:
Ford Motor Company
Customer Relationship Center
P.O. Box 6248
Dearborn, MI 48121
1-800-521-4140
(TDD for the hearing impaired: 1-800-232-5952)
www.customersaskford.com

In Canada:
Lincoln Centre
Ford Motor Company of Canada, Limited
P.O. Box 2000
Oakville, Ontario L6J 5E4
1-800-387-9333
www.lincolncanada.com

In order to help you service your Lincoln vehicle, please have the following information available when contacting the Lincoln Centre:

- Your telephone number (home and business)
- The name of the dealer and the city where the dealership is located
- The year and make of your vehicle
- The date of vehicle purchase
- The current odometer reading
- The vehicle identification number (VIN)

Additional Assistance

If you still have a complaint involving a warranty dispute, you may wish to contact the Dispute Settlement Board (U.S.).

Customer Assistance

In some states (in the U.S.) you must directly notify Ford in writing before pursuing remedies under your state's warranty laws. Ford is also allowed a final repair attempt in some states.

In the United States, a warranty dispute must be submitted to the Dispute Settlement Board before taking action under the Magnuson-Moss Warranty Act, or to the extent allowed by state law, before pursuing replacement or repurchase remedies provided by certain state laws. This dispute handling procedure is not required prior to enforcing state created rights or other rights which are independent of the Magnuson-Moss Warranty Act or state replacement or repurchase laws.

IN CALIFORNIA (U.S. ONLY)

California Civil Code Section 1793.2(d) requires that, if a manufacturer or its representative is unable to repair a motor vehicle to conform to the vehicle's applicable express warranty after a reasonable number of attempts, the manufacturer shall be required to either replace the vehicle with one substantially identical or repurchase the vehicle and reimburse the buyer in an amount equal to the actual price paid or payable by the consumer (less a reasonable allowance for consumer use). The consumer has the right to choose whether to receive a refund or replacement vehicle.

California Civil Code Section 1793.22(b) presumes that the manufacturer has had a reasonable number of attempts to conform the vehicle to its applicable express warranties if, within the first 18 months of ownership of a new vehicle or the first 18,000 miles (29,000 km), whichever occurs first:

1. Two or more repair attempts are made on the same non-conformity likely to cause death or serious bodily injury OR
2. Four or more repair attempts are made on the same nonconformity (a defect or condition that substantially impairs the use, value or safety of the vehicle) OR
3. The vehicle is out of service for repair of nonconformities for a total of more than 30 calendar days (not necessarily all at one time)

In the case of 1 or 2 above, the consumer must also notify the manufacturer of the need for the repair of the nonconformity at the following address:

Ford Motor Company
16800 Executive Plaza Drive
Mail Drop 3NE-B
Dearborn, MI 48126

248

2005 Explorer (exp)
Owners Guide (post-2002-fmt)
USA (fus)

Customer Assistance

THE DISPUTE SETTLEMENT BOARD (U.S. ONLY)

The Dispute Settlement Board is:

- an independent, third-party arbitration program for warranty disputes.
- available free to owners and lessees of qualifying Ford Motor Company vehicles.

The Dispute Settlement Board may not be available in all states. Ford Motor Company reserves the right to change eligibility limitations, modify procedures and/or to discontinue this service without notice and without incurring obligations per applicable state law.

What kinds of cases does the Board review?

Unresolved warranty repair concerns or vehicle performance concerns as on Ford and Lincoln Mercury cars and Ford and Lincoln Mercury light trucks which are within the terms of any applicable written new vehicle warranty are eligible for review, except those involving:

- a non-Ford product
- a non-Ford dealership
- sales disputes between customer and dealer except those associated with warranty repairs or concerns with the vehicle's performance as designed
- a request for reimbursement of consequential expenses unless a service or product concern is being reviewed
- items not covered by the New Vehicle Limited Warranty (including maintenance and wear items)
- alleged personal injury/property damage claims
- cases currently in litigation
- vehicles not used primarily for family, personal or household purposes (except in states where the Dispute Settlement Board is required to review commercial vehicles)
- vehicles with non-U.S. warranties

Concerns are ineligible for review if the New Vehicle Limited Warranty has expired at receipt of your application and, in certain states eligibility is dependent upon the customer's possession of the vehicle.

Eligibility may differ according to state law. For example, see the unique brochures for California, West Virginia, Georgia and Wisconsin purchasers/lessees.

Customer Assistance

Board membership

The Board consists of:

- Three consumer representatives
- A Ford or Lincoln Mercury dealership representative

Consumer candidates for Board membership are recruited and trained by an independent consulting firm. The dealership Board member is chosen from Ford and Lincoln Mercury dealership management, recognized for their business leadership qualities.

What the Board needs

To have your case reviewed you must complete the application in the DSB brochure and mail it to the address provided on the application form. Some states will require you to use certified mail, with return receipt requested.

Your application is reviewed and, if it is determined to be eligible, you will receive an acknowledgment indicating:

- The file number assigned to your application.
- The toll-free phone number of the DSB's independent administrator.

Your dealership and a Ford Motor Company representative will then be asked to submit statements.

To properly review your case, the Board needs the following information:

- Legible copies of all documents and maintenance or repair orders relevant to the case.
- The year, make, model, and Vehicle Identification Number (VIN) listed on your vehicle ownership license.
- The date of repair(s) and mileage at the time of occurrence(s).
- The current mileage.
- The name of the dealer(s) who sold or serviced the vehicle.
- A brief description of your unresolved concern.
- A brief summary of the action taken by the dealer(s) and Ford Motor Company.
- The names (if known) of all the people you contacted at the dealership(s).
- A description of the action you expect to resolve your concern.

You will receive a letter of explanation if your application does not qualify for Board review.

250

2005 Explorer (exp)
Owners Guide (post-2002-fmt)
USA (fus)

Customer Assistance

Oral presentations

If you would like to make an oral presentation, indicate YES to question 6 on the application. While it is your right to make an oral presentation before the Board, this is not a requirement and the Board will decide the case whether or not an oral presentation is made. An oral presentation may be requested by the Board as well.

Making a decision

Board members review all available information related to each complaint, including oral presentations, and arrive at a fair and impartial decision. Board review may be terminated at any time by either party.

Every effort is made to decide the case within 40 days of the date that all requested information is received by the Board. Since the Board generally meets once a month, it may take longer for the Board to consider some cases.

After a case is reviewed, the Board mails you a decision letter and a form on which to accept or reject the Board's decision. The decisions of the Board are binding on Ford (and, in some cases, on the dealer) but not on consumers who are free to pursue other remedies available to them under state or federal law.

To request a DSB Brochure/Application

For a brochure/application, speak to your dealer or write/call the Board at the following address/phone number:

Dispute Settlement Board
P.O. Box 1424
Waukesha, WI 53187-1424
1-800-428-3718

You may also contact the North American Customer Relationship Center at 1-800-392-3673 (Ford), TDD for the hearing impaired: 1-800-232-5952 or by writing to the Center at the following address:

Ford Motor Company
Customer Relationship Center
P.O. Box 6248
Dearborn, Michigan 48121

UTILIZING THE MEDIATION/ARBITRATION PROGRAM (CANADA ONLY)

For vehicles delivered to authorized Canadian dealerships. In those cases where you continue to feel that the efforts by Ford of Canada and the

Customer Assistance

dealer to resolve a factory-related vehicle service concern have been unsatisfactory, Ford of Canada participates in an impartial third party mediation/arbitration program administered by the Canadian Motor Vehicle Arbitration Plan (CAMVAP).

The CAMVAP program is a straight-forward and relatively speedy alternative to resolve a disagreement when all other efforts to produce a settlement have failed. This procedure is without cost to you and is designed to eliminate the need for lengthy and expensive legal proceedings.

In the CAMVAP program, impartial third-party arbitrators conduct hearings at mutually convenient times and places in an informal environment. These impartial arbitrators review the positions of the parties, make decisions and, when appropriate, render awards to resolve disputes. CAMVAP decisions are fast, fair, and final as the arbitrator's award is binding both to you and Ford of Canada.

CAMVAP services are available in all territories and provinces. For more information, without charge or obligation, call your CAMVAP Provincial Administrator directly at 1-800-207-0685.

FORD EXTENDED SERVICE PLAN

You can get more protection for your new car or light truck by purchasing Ford Extended Service Plan (Ford ESP) coverage. It provides the following:

- Benefits during the warranty period depending on the plan you purchase (such as: reimbursement for rentals; coverage for certain maintenance and wear items).
- Protection against covered repair costs after your Bumper-to-Bumper Warranty expires.

You may purchase Ford ESP from any participating Ford and Lincoln Mercury and Ford of Canada dealer. There are several plans available in various time, distance and deductible combinations which can be tailored to fit your own driving needs. Ford ESP also offers reimbursement benefits for towing and rental coverage.

When you buy Ford ESP, you receive Peace-of-Mind protection throughout the United States and Canada, provided by a network of more than 4,600 participating Ford or Lincoln Mercury and Ford of Canada dealers.

If you did not take advantage of the Ford Extended Service Plan at the time of purchasing your vehicle, you may still be eligible. Since this

252

2005 Explorer (exp)
Owners Guide (post-2002-fmt)
USA (fus)

Customer Assistance

information is subject to change, please ask your dealer for complete details about Ford Extended Service Plan coverage options, or visit the Ford ESP website at www.ford-esp.com.

GETTING ASSISTANCE OUTSIDE THE U.S. AND CANADA

Before exporting your vehicle to a foreign country, contact the appropriate foreign embassy or consulate. These officials can inform you of local vehicle registration regulations and where to find unleaded fuel.

If you cannot find unleaded fuel or can only get fuel with an anti-knock index lower than is recommended for your vehicle, contact a regional office or owner relations/customer relationship office.

The use of leaded fuel in your vehicle without proper conversion may damage the effectiveness of your emission control system and may cause engine knocking or serious engine damage. Ford Motor Company/Ford of Canada is not responsible for any damage caused by use of improper fuel. Using leaded fuel may also result in difficulty importing your vehicle back into the U.S.

If your vehicle must be serviced while you are traveling or living in Central or South America, the Caribbean, or the Middle East, contact the nearest Ford dealership. If the dealership cannot help you, write or call:

FORD MOTOR COMPANY
WORLDWIDE DIRECT MARKET OPERATIONS
1555 Fairlane Drive
Fairlane Business Park #3
Allen Park, Michigan 48101
U.S.A.
Telephone: (313) 594-4857
FAX: (313) 390-0804

If you are in another foreign country, contact the nearest Ford dealership. If the dealership employees cannot help you, they can direct you to the nearest Ford affiliate office.

If you buy your vehicle in North America and then relocate outside of the U.S. or Canada, register your vehicle identification number (VIN) and new address with Ford Motor Company Worldwide Direct Market Operations.

ORDERING ADDITIONAL OWNER'S LITERATURE

To order the publications in this portfolio, contact Helm, Incorporated at:

HELM, INCORPORATED
P.O. Box 07150
Detroit, Michigan 48207

Customer Assistance

Or call:

For a free publication catalog, order toll free: 1-800-782-4356

Monday-Friday 8:00 a.m. - 6:00 p.m. EST

Helm, Incorporated can also be reached by their website:
www.helminc.com.

(Items in this catalog may be purchased by credit card, check or money order.)

Obtaining a French owner's guide

French Owner's Guides can be obtained from your dealer or by writing to Ford Motor Company of Canada, Limited, Service Publications, P.O. Box 1580, Station B, Mississauga, Ontario L4Y 4G3.

REPORTING SAFETY DEFECTS (U.S. ONLY)

If you believe that your vehicle has a defect which could cause a crash or could cause injury or death, you should immediately inform the National Highway Traffic Safety Administration (NHTSA) in addition to notifying Ford Motor Company.



If NHTSA receives similar complaints, it may open an investigation, and if it finds that a safety defect exists in a group of vehicles, it may order a recall and remedy campaign. However, NHTSA cannot become involved in individual problems between you, your dealer, or Ford Motor Company.

To contact NHTSA, you may either call the Auto Safety Hotline toll-free at 1-800-424-9393 (or 366-0123 in the Washington D.C. area) or write to:

NHTSA
400 Seventh Street
U.S. Department of Transportation
Washington, D.C. 20590

You can also obtain other information about motor vehicle safety from the Hotline.

254

2005 Explorer (exp)
Owners Guide (post-2002-fmt)
USA (fus)

WASHING THE EXTERIOR

Wash your vehicle regularly with cool or lukewarm water and a neutral pH shampoo, such as Motorcraft Detail Wash (ZC-3-A), which is available from your dealer.

- Never use strong household detergents or soap, such as dish washing or laundry liquid. These products can discolor and spot painted surfaces.
- Never wash a vehicle that is “hot to the touch” or during exposure to strong, direct sunlight.
- Always use a clean sponge or car wash mitt with plenty of water for best results.
- Dry the vehicle with a chamois or soft terry cloth towel in order to eliminate water spotting.
- It is especially important to wash the vehicle regularly during the winter months, as dirt and road salt are difficult to remove and cause damage to the vehicle.
- Immediately remove items such as gasoline, diesel fuel, bird droppings and insect deposits because they can cause damage to the vehicle’s paintwork and trim over time.
- Remove any exterior accessories, such as antennas, before entering a car wash.
- **Suntan lotions and insect repellents can damage any painted surface; if these substances come in contact with your vehicle, wash off as soon as possible.**
- **If your vehicle is equipped with running boards, do not use rubber, plastic and vinyl protectant products on the running board surface, as the area may become slippery.**

WAXING

Applying Motorcraft Paint Sealant (ZC-45) to your vehicle every six months will assist in reducing minor scratches and paint damage.

- Wash the vehicle first.
- Do not use waxes that contain abrasives; use Motorcraft Premium Liquid Wax (ZC-53-A), which is available from your dealer, or an equivalent quality product.
- Do not allow paint sealant to come in contact with any non-body (low-gloss black) colored trim, such as grained door handles, roof

Cleaning

racks, bumpers, side moldings, mirror housings or the windshield cowl area. The paint sealant will “gray” or stain the parts over time.

PAINT CHIPS

Your dealer has touch-up paint and sprays to match your vehicle's color. Take your color code (printed on a sticker in the driver's door jamb) to your dealer to ensure you get the correct color.

- Remove particles such as bird droppings, tree sap, insect deposits, tar spots, road salt and industrial fallout before repairing paint chips.
- Always read the instructions before using the products.

ALUMINUM WHEELS AND WHEEL COVERS

Aluminum wheels and wheel covers are coated with a clearcoat paint finish. In order to maintain their shine:

- Clean weekly with Motorcraft Wheel and Tire Cleaner (ZC-37-A), which is available from your dealer. Heavy dirt and brake dust accumulation may require agitation with a sponge. Rinse thoroughly with a strong stream of water.
- Never apply any cleaning chemical to hot or warm wheel rims or covers.
- Some automatic car washes may cause damage to the finish on your wheel rims or covers. Chemical-strength cleaners, or cleaning chemicals, in combination with brush agitation to remove brake dust and dirt, could wear away the clearcoat finish over time.
- Do not use hydrofluoric acid-based or high caustic-based wheel cleaners, steel wool, fuels or strong household detergent.
- To remove tar and grease, use Motorcraft Bug and Tar Remover (ZC-42), available from your dealer.

ENGINE

Engines are more efficient when they are clean because grease and dirt buildup keep the engine warmer than normal. When washing:

- Take care when using a power washer to clean the engine. The high pressure fluid could penetrate the sealed parts and cause damage.
- Do not spray a hot engine with cold water to avoid cracking the engine block or other engine components.
- Spray Motorcraft Engine Shampoo and Degreaser (ZC-20) on all parts that require cleaning and pressure rinse clean.

256

*2005 Explorer (exp)
Owners Guide (post-2002-fmt)
USA (fus)*

Cleaning

- Cover the highlighted areas to prevent water damage when cleaning the engine.

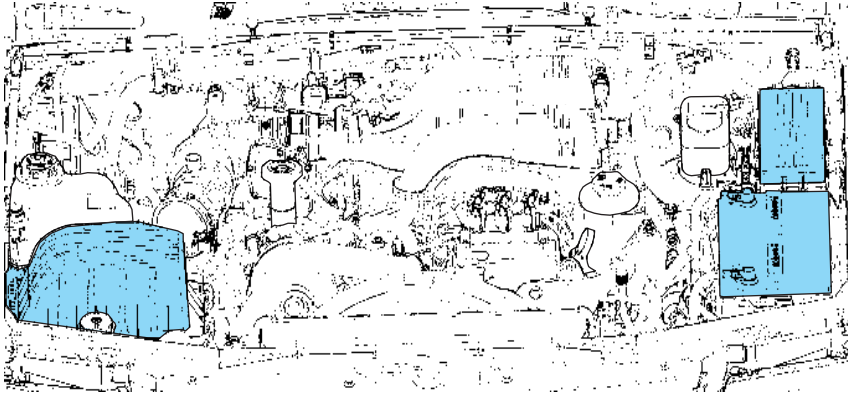

4.0L SOHC V6 Engine

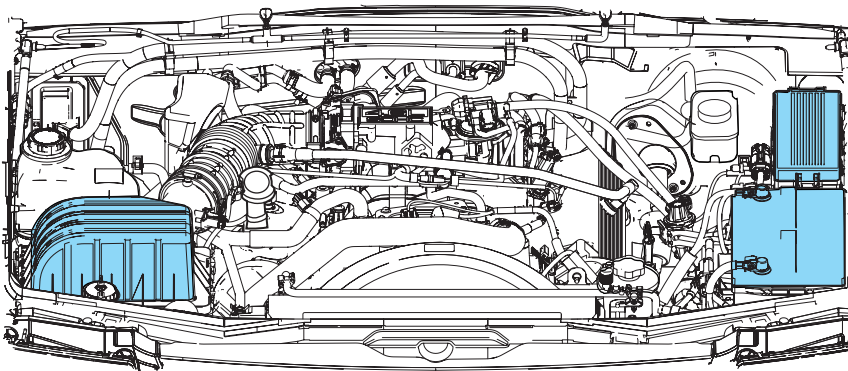

4.6L V8 Engine

- Never wash or rinse the engine while it is running; water in the running engine may cause internal damage.

PLASTIC (NON-PAINTED) EXTERIOR PARTS

Use only approved products to clean plastic parts. These products are available from your dealer.

Cleaning

- For routine cleaning, use Motorcraft Detail Wash (ZC-3-A).
- If tar or grease spots are present, use Motorcraft Bug and Tar Remover (ZC-42).

WINDOWS AND WIPER BLADES

The windshield, rear and side windows and the wiper blades should be cleaned regularly. If the wipers do not wipe properly, substances on the vehicle's glass or the wiper blades may be the cause. These may include hot wax treatments used by commercial car washes, tree sap, or other organic contamination. To clean these items, please follow these tips:

- The windshield, rear windows and side windows may be cleaned with a non-abrasive cleaner such as Motorcraft Ultra-Clear Spray Glass Cleaner (ZC-23), available from your dealer.
- Do not use abrasives, as they may cause scratches.
- Do not use fuel, kerosene, or paint thinner to clean any parts.
- Wiper blades can be cleaned with isopropyl (rubbing) alcohol or windshield washer solution. Be sure to replace wiper blades when they appear worn or do not function properly.

Do not use sharp objects, such as a razor blade, to clean the inside of the rear window or to remove decals, as it may cause damage to the rear window defroster's heated grid lines.

INSTRUMENT PANEL AND CLUSTER LENS

Clean the instrument panel with a damp cloth, then with a clean, dry cloth, or use Motorcraft Dash & Vinyl Cleaner (ZC-38-A).

- Avoid cleaners or polish that increase the gloss of the upper portion of the instrument panel. The dull finish in this area helps protect the driver from undesirable windshield reflection.



Do not use chemical solvents or strong detergents when cleaning the steering wheel or instrument panel to avoid contamination of the air bag system.

- Be certain to wash or wipe your hands clean if you have been in contact with certain products such as insect repellent and suntan lotion in order to avoid possible damage to the interior painted surfaces.

INTERIOR TRIM

- Clean the interior trim areas with a damp cloth, then with a clean, dry cloth.

258

2005 Explorer (exp)
Owners Guide (post-2002-fmt)
USA (fus)

Cleaning

- Do not use household or glass cleaners as these may damage the finish.

INTERIOR

For fabric, carpets, cloth seats and safety belts:

- Remove dust and loose dirt with a vacuum cleaner.
- Remove light stains and soil with Motorcraft Professional Strength Carpet & Upholstery Cleaner (ZC-54).
- If grease or tar is present on the material, spot-clean the area first with Motorcraft Spot and Stain Remover (ZC-14).
- If a ring forms on the fabric after spot cleaning, clean the entire area immediately (but do not oversaturate) or the ring will set.
- Do not use household cleaning products or glass cleaners, which can stain and discolor the fabric and affect the flame retardant abilities of the seat materials.



Do not use cleaning solvents, bleach or dye on the vehicle's seatbelts, as these actions may weaken the belt webbing.

LEATHER SEATS (IF EQUIPPED)

Your leather seating surfaces have a clear, protective coating over the leather.

- To clean, use a soft cloth with Motorcraft Deluxe Leather and Vinyl Cleaner (ZC-11-A). Dry the area with a soft cloth.
- To help maintain its resiliency and color, use the Motorcraft Deluxe Leather Care Kit (ZC-11-D), available from your authorized dealer.
- Do not use household cleaning products, alcohol solutions, solvents or cleaners intended for rubber, vinyl and plastics, or oil/petroleum-based leather conditioners. These products may cause premature wearing of the clear, protective coating.

Note: In some instances, color or dye transfer can occur when wet clothing comes in contact with leather upholstery. If this occurs, the leather should be cleaned immediately to avoid permanent staining.

UNDERBODY

Flush the complete underside of your vehicle frequently. Keep body and door drain holes free from packed dirt.

Cleaning

FORD AND LINCOLN MERCURY CAR CARE PRODUCTS

Your Ford or Lincoln Mercury dealer has many quality products available to clean your vehicle and protect its finishes. These quality products have been specifically engineered to fulfill your automotive needs; they are custom designed to complement the style and appearance of your vehicle. Each product is made from high quality materials that meet or exceed rigid specifications. For best results, use the following products or products of equivalent quality:

- Motorcraft Bug and Tar Remover (ZC-42)
- Motorcraft Car Care Kit (ZC-26)
- Motorcraft Car Wash (Canada only) (CXC-21)
- Motorcraft Custom Bright Metal Cleaner (ZC-15)
- Motorcraft Custom Clear Coat Polish (ZC-8-A)
- Motorcraft Custom Vinyl Protectant (U.S. only) (ZC-40-A)
- Motorcraft Dash and Vinyl Cleaner (ZC-38-A)
- Motorcraft Deluxe Leather and Vinyl Cleaner (U.S. only) (ZC-11-A)
- Motorcraft Detail Wash (ZC-3-A)
- Motorcraft Dusting Cloth (ZC-24)
- Motorcraft Engine Shampoo and Degreaser (U.S. only) (ZC-20)
- Motorcraft Engine Shampoo (Canada only) (CXC-66-A)
- Motorcraft One Step Wash and Wax Concentrate (ZC-6-A)
- Motorcraft Paint Sealant (ZC-45)
- Motorcraft Premium Car Wash Concentrate (U.S. only) (ZC-17-B)
- Motorcraft Premium Glass Cleaner (Canada only) (CXC-100)
- Motorcraft Premium Liquid Wax (ZC-53-A)
- Motorcraft Professional Strength Carpet & Upholstery Cleaner (ZC-54)
- Motorcraft Spot and Stain Remover (U.S. only) (ZC-14)
- Motorcraft Tire Clean and Shine (ZC-28)
- Motorcraft Triple Clean (U.S. only) (ZC-13)
- Motorcraft Ultra-Clear Spray Glass Cleaner (ZC-23)
- Motorcraft Vinyl Cleaner (Canada only) (CXC-93)
- Motorcraft Vinyl Conditioner (Canada only) (CXC-94)
- Motorcraft Wheel and Tire Cleaner (ZC-37-A)

260

2005 Explorer (exp)
Owners Guide (post-2002-fmt)
USA (fus)

Maintenance and Specifications

SERVICE RECOMMENDATIONS

- Use the *scheduled maintenance information* to track routine service.
- Use only recommended fuels, lubricants, fluids and service parts conforming to specifications.
- Your dealership can provide parts and service.

PRECAUTIONS WHEN SERVICING YOUR VEHICLE

- Do not work on a hot engine.
- Make sure that nothing gets caught in moving parts.
- Do not work on a vehicle with the engine running in an enclosed space, unless you are sure you have enough ventilation.
- Keep all open flames and other lit material away from the battery and all fuel related parts.

Working with the engine off

1. Set the parking brake and shift to P (Park).
2. Turn off the engine and remove the key.
3. Block the wheels.

Working with the engine on

1. Set the parking brake and shift to P (Park).
2. Block the wheels.



Do not start your engine with the air cleaner removed and do not remove it while the engine is running.

Maintenance and Specifications

OPENING THE HOOD

1. Inside the vehicle, pull the hood release handle located under the bottom left corner of the instrument panel.

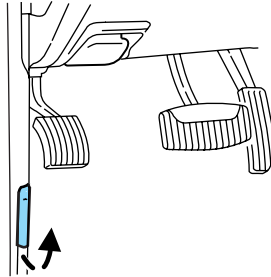

2. Go to the front of the vehicle and release the auxiliary latch that is located under the front center of the hood.

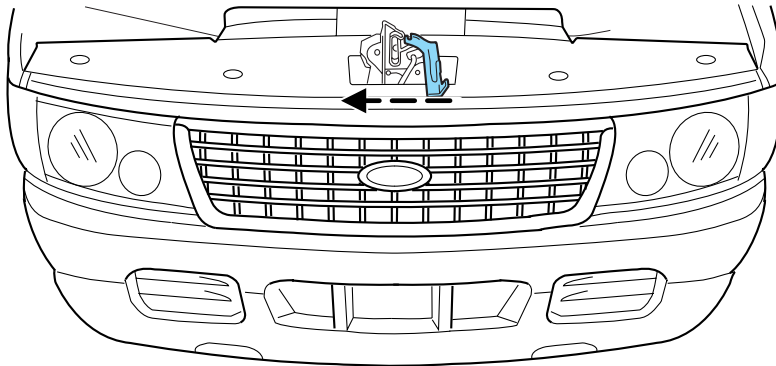

3. Lift the hood.

Maintenance and Specifications

IDENTIFYING COMPONENTS IN THE ENGINE COMPARTMENT

4.0L SOHC V6 engine

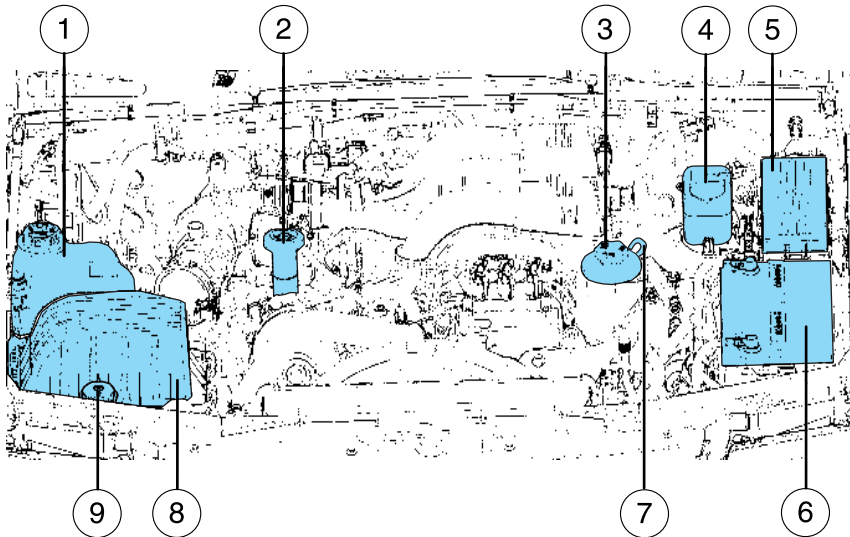

1. Engine coolant reservoir
2. Engine oil filler cap
3. Power steering fluid reservoir
4. Brake fluid reservoir
5. Power distribution box
6. Battery
7. Engine oil dipstick
8. Air filter assembly
9. Windshield washer fluid reservoir

Maintenance and Specifications

4.6L V8 engine

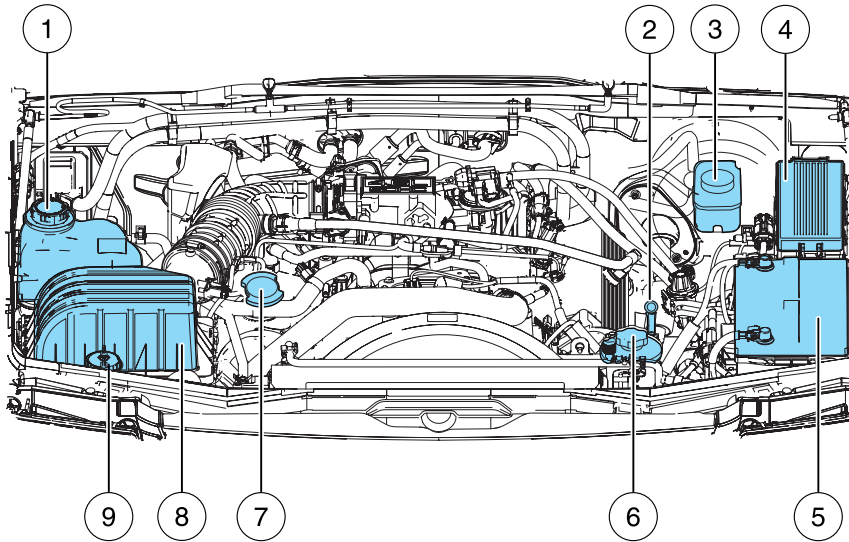

1. Engine coolant reservoir
2. Engine oil dipstick
3. Brake fluid reservoir
4. Power distribution box
5. Battery
6. Power steering fluid reservoir
7. Engine oil filler cap
8. Air filter assembly
9. Windshield washer fluid reservoir

Maintenance and Specifications

WINDSHIELD WASHER FLUID

Add fluid to fill the reservoir if the level is low. In very cold weather, do not fill the reservoir completely.

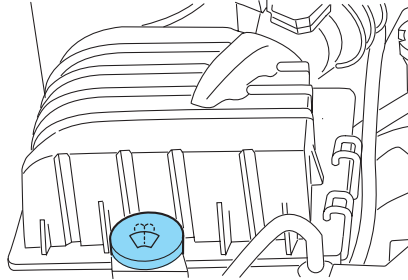

Only use a washer fluid that meets Ford specification WSB-M8B16-A2. Refer to *Lubricant specifications* later in this chapter.

State or local regulations on volatile organic compounds may restrict the use of methanol, a common windshield washer antifreeze additive. Washer fluids containing non-methanol antifreeze agents should be used only if they provide cold weather protection without damaging the vehicle's paint finish, wiper blades or washer system.



If you operate your vehicle in temperatures below 40° F (4.5°C), use washer fluid with antifreeze protection. Failure to use washer fluid with antifreeze protection in cold weather could result in impaired windshield vision and increase the risk of injury or accident.

Do not put washer fluid in the engine coolant reservoir. Washer fluid placed in the cooling system may harm engine and cooling system components.

Checking and adding washer fluid for the liftgate

Washer fluid for the liftgate is supplied by the same reservoir as the windshield.

ENGINE OIL

Checking the engine oil

Refer to the *scheduled maintenance information* for the appropriate intervals for checking the engine oil.

1. Make sure the vehicle is on level ground.
2. Turn the engine off and wait a few minutes for the oil to drain into the oil pan.

Maintenance and Specifications

3. Set the parking brake and ensure the gearshift is securely latched in P (Park).
 4. Open the hood. Protect yourself from engine heat.
 5. Locate and carefully remove the engine oil level indicator (dipstick).
- 4.0L V6 engine

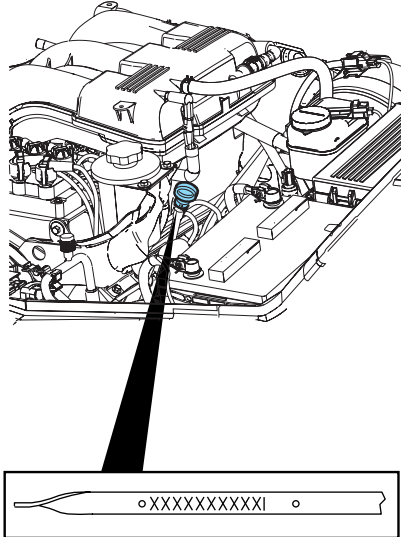

Maintenance and Specifications

- 4.6L V8 engine

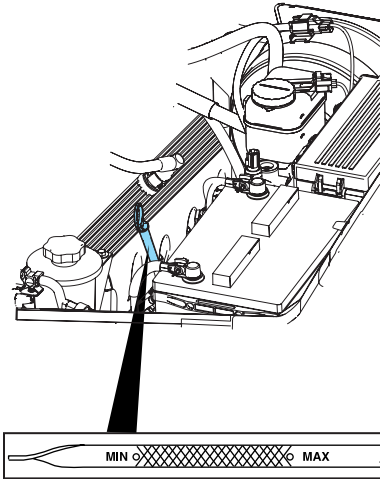

6. Wipe the indicator clean. Insert the indicator fully, then remove it again.

- If the oil level is **between the MIN and MAX marks**, the oil level is acceptable, **DO NOT ADD OIL.**
- If the oil level is below the MIN mark, add enough oil to raise the level within the MIN-MAX range .
- 4.0L SOHC V6 engine

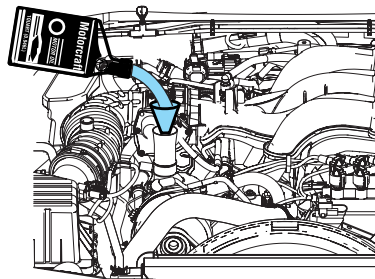

Maintenance and Specifications

- 4.6L V8 engine

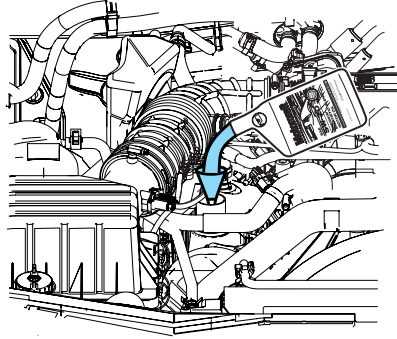

- Oil levels above the MAX mark may cause engine damage. Some oil must be removed from the engine by a service technician.
7. Put the indicator back in and ensure it is fully seated.

Adding engine oil

1. Check the engine oil. For instructions, refer to *Checking the engine oil* in this chapter.
2. If the engine oil level is not within the normal range, add only certified engine oil of the recommended viscosity. Remove the engine oil filler cap and use a funnel to pour the engine oil into the opening.
3. Recheck the engine oil level. Make sure the oil level is not above the MAX mark on the engine oil level indicator (dipstick).
4. Install the indicator and ensure it is fully seated.
5. Fully install the engine oil filler cap by turning the filler cap clockwise 1/4 of a turn or until three clicks can be heard.

To avoid possible oil loss, DO NOT operate the vehicle with the engine oil level indicator and/or the engine oil filler cap removed.

Maintenance and Specifications

Engine Oil Recommendations

4.6L Engine

Look for this certification trademark.

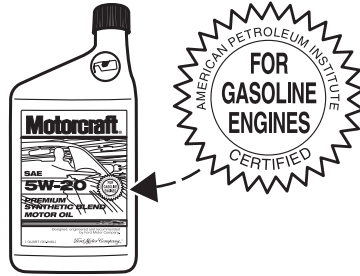

Use SAE 5W-20 engine oil.

Only use oils “Certified For Gasoline Engines” by the American Petroleum Institute (API). An oil with this trademark symbol conforms to the current engine and emission system protection standards and fuel economy requirements of the International Lubricant Standardization and Approval Committee (ILSAC), comprised of U.S. and Japanese automobile manufacturers.

To protect your engine’s warranty use Motorcraft SAE 5W-20 or an equivalent 5W-20 oil meeting Ford specification WSS-M2C930-A. **SAE 5W-20 oil provides optimum fuel economy and durability performance meeting all requirements for your vehicle’s engine.**

Do not use supplemental engine oil additives, cleaners or other engine treatments. They are unnecessary and could lead to engine damage that is not covered by Ford warranty.

Change your engine oil according to the appropriate schedule listed in the *scheduled maintenance information*.

Maintenance and Specifications

4.0L Engine

Look for this certification trademark.

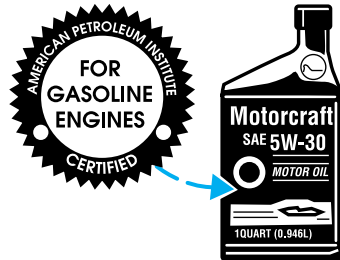

Use SAE 5W-30 engine oil.

Only use oils “Certified For Gasoline Engines” by the American Petroleum Institute (API). An oil with this trademark symbol conforms to the current engine and emission system protection standards and fuel economy requirements of the International Lubricant Standardization and Approval Committee (ILSAC), comprised of U.S. and Japanese automobile manufacturers.

To protect your engine’s warranty use Motorcraft SAE 5W-30 or an equivalent 5W-30 oil meeting Ford specification WSS-M2C929-A.

Do not use supplemental engine oil additives, cleaners or other engine treatments. They are unnecessary and could lead to engine damage that is not covered by Ford warranty.

Change your engine oil according to the appropriate schedule listed in the *scheduled maintenance information*.

Ford production and aftermarket (Motorcraft) oil filters are designed for added engine protection and long life. If a replacement oil filter is used that does not meet Ford material and design specifications, start-up engine noises or knock may be experienced.

It is recommended you use the appropriate Motorcraft oil filter (or another brand meeting Ford specifications) for your engine application.

Maintenance and Specifications

BATTERY

Your vehicle is equipped with a Motorcraft maintenance-free battery which normally does not require additional water during its life of service.

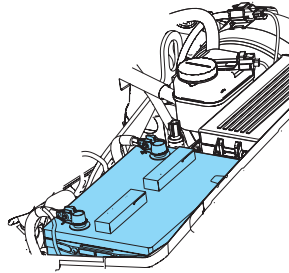

However, for severe usage or in high temperature climates, check the battery electrolyte level. Refer to *scheduled maintenance information* for the service interval schedules.

Keep the electrolyte level in each cell up to the “level indicator”. Do not overfill the battery cells.

If the electrolyte level in the battery is low, you can add plain tap water to the battery, as long as you do not use hard water (water with a high mineral or alkali content). If possible, however, try to only fill the battery cells with distilled water. If the battery needs water often, have the charging system checked.

If your battery has a cover/shield, make sure it is reinstalled after the battery has been cleaned or replaced.

For longer, trouble-free operation, keep the top of the battery clean and dry. Also, make certain the battery cables are always tightly fastened to the battery terminals.

If you see any corrosion on the battery or terminals, remove the cables from the terminals and clean with a wire brush. You can neutralize the acid with a solution of baking soda and water.



Batteries normally produce explosive gases which can cause personal injury. Therefore, do not allow flames, sparks or lighted substances to come near the battery. When working near the battery, always shield your face and protect your eyes. Always provide proper ventilation.

Maintenance and Specifications



When lifting a plastic-cased battery, excessive pressure on the end walls could cause acid to flow through the vent caps, resulting in personal injury and/or damage to the vehicle or battery. Lift the battery with a battery carrier or with your hands on opposite corners.



Keep batteries out of reach of children. Batteries contain sulfuric acid. Avoid contact with skin, eyes or clothing. Shield your eyes when working near the battery to protect against possible splashing of acid solution. In case of acid contact with skin or eyes, flush immediately with water for a minimum of 15 minutes and get prompt medical attention. If acid is swallowed, call a physician immediately.



Battery posts, terminals and related accessories contain lead and lead compounds. **Wash hands after handling.**

Because your vehicle's engine is electronically controlled by a computer, some control conditions are maintained by power from the battery. When the battery is disconnected or a new battery is installed, the engine must relearn its idle and fuel trim strategy for optimum driveability and performance. To begin this process:

1. With the vehicle at a complete stop, set the parking brake.
 2. Put the gearshift lever in P (Park), turn off all accessories and start the engine.
 3. Run the engine until it reaches normal operating temperature.
 4. Allow the engine to idle for at least one minute.
 5. Turn the A/C on and allow the engine to idle for at least one minute.
 6. Drive the vehicle to complete the relearning process.
- The vehicle may need to be driven to relearn the idle and fuel trim strategy.
 - **If you do not allow the engine to relearn its idle trim, the idle quality of your vehicle may be adversely affected until the idle trim is eventually relearned.**

When the battery is disconnected or a new battery installed, the transmission must relearn its adaptive strategy. As a result of this, the transmission may shift firmly. This operation is considered normal and will not affect function or durability of the transmission. Over time the adaptive learning process will fully update transmission operation to its optimum shift feel.

272

Maintenance and Specifications

If the battery has been disconnected or a new battery has been installed, the clock and the preset radio stations must be reset once the battery is reconnected.

- Always dispose of automotive batteries in a responsible manner. Follow your local authorized standards for disposal. Call your local authorized recycling center to find out more about recycling automotive batteries.

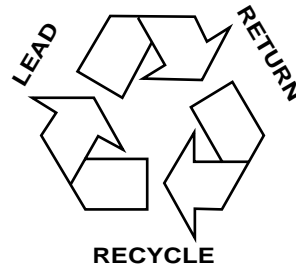

ENGINE COOLANT

Checking engine coolant

The concentration and level of engine coolant should be checked at the mileage intervals listed in *scheduled maintenance information*. The coolant concentration should be maintained at 50/50 coolant and distilled water, which equates to a freeze point of -34°F (-36°C). Coolant concentration testing is possible with a hydrometer or antifreeze tester (such as the Rotunda Battery and Antifreeze Tester, 014-R1060). The level of coolant should be maintained at the "FULL COLD" level or within the "COLD FILL RANGE" in the coolant reservoir. If the level falls below, add coolant per the instructions in the *Adding engine coolant* section.

Your vehicle was factory-filled with a 50/50 engine coolant and water concentration. If the concentration of coolant falls below 40% or above 60%, the engine parts could become damaged or not work properly. **A 50-50 mixture of coolant and water provides the following:**

- **Freeze protection down to -34°F (-36°C).**
- **Boiling protection up to 265°F (129°C).**
- **Protection against rust and other forms of corrosion.**
- **Enables calibrated gauges to work properly.**

Maintenance and Specifications

When the engine is cold, check the level of the engine coolant in the reservoir.

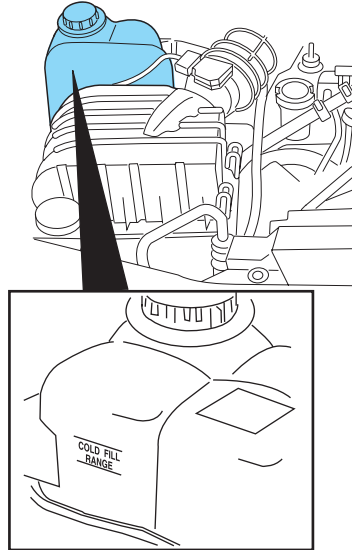

- The engine coolant should be at the “FULL COLD” level or within the “COLD FILL RANGE” as listed on the engine coolant reservoir (depending upon application).
- Refer to *scheduled maintenance information* for service interval schedules.
- Be sure to read and understand *Precautions when servicing your vehicle* in this chapter.

If the engine coolant has not been checked at the recommended interval, the engine coolant reservoir may become low or empty. If the reservoir is low or empty, add engine coolant to the reservoir. Refer to *Adding engine coolant* in this chapter.

Note: Automotive fluids are not interchangeable; do not use engine coolant, antifreeze or windshield washer fluid outside of its specified function and vehicle location.

Adding engine coolant

When adding coolant, make sure it is a 50/50 mixture of engine coolant and distilled water. Add the mixture to the coolant reservoir, **when the engine is cool**, until the appropriate fill level is obtained.

274

2005 Explorer (exp)
Owners Guide (post-2002-fmt)
USA (fus)

Maintenance and Specifications



Do not add engine coolant when the engine is hot. Steam and scalding liquids released from a hot cooling system can burn you badly. Also, you can be burned if you spill coolant on hot engine parts.



Do not put engine coolant in the windshield washer fluid container. If sprayed on the windshield, engine coolant could make it difficult to see through the windshield.

- **Add Motorcraft Premium Gold Engine Coolant (yellow-colored), VC-7-A (U.S., except CA, OR and NM), VC-7-B (CA, OR and NM), meeting Ford Specification WSS-M97B51-A1.**

Note: Use of Motorcraft Cooling System Stop Leak Pellets, VC-6, may darken the color of Motorcraft Premium Gold Engine Coolant from yellow to golden tan.

- **Do not add/mix an orange-colored, extended life coolant such as Motorcraft Specialty Orange Engine Coolant, VC-2 (US) or CXC-209 (Canada), meeting Ford specification WSS-M97B44-D with the factory-filled coolant.** Mixing Motorcraft Specialty Orange Engine Coolant or any orange-colored extended life product with your factory filled coolant can result in degraded corrosion protection.
- A large amount of water without engine coolant may be added, in case of emergency, to reach a vehicle service location. In this instance, the cooling system must be drained and refilled with a 50/50 mixture of engine coolant and distilled water as soon as possible. Water alone (without engine coolant) can cause engine damage from corrosion, overheating or freezing.
- **Do not use alcohol, methanol, brine or any engine coolants mixed with alcohol or methanol antifreeze (coolant).** Alcohol and other liquids can cause engine damage from overheating or freezing.
- **Do not add extra inhibitors or additives to the coolant.** These can be harmful and compromise the corrosion protection of the engine coolant.

For vehicles with overflow coolant systems with a non-pressurized cap on the coolant recovery system, add coolant to the coolant recovery reservoir when the engine is cool. Add the proper mixture of coolant and water to the "FULL COLD" level. For all other vehicles, which have a coolant degas system with a pressurized cap, or if it is necessary to

Maintenance and Specifications

remove the coolant pressure relief cap on the radiator of a vehicle with an overflow system, follow these steps to add engine coolant.



To reduce the risk of personal injury, make sure the engine is cool before unscrewing the coolant pressure relief cap. The cooling system is under pressure; steam and hot liquid can come out forcefully when the cap is loosened slightly.

1. Before you begin, turn the engine off and let it cool.
2. When the engine is cool, wrap a thick cloth around the coolant pressure relief cap on the coolant reservoir (a translucent plastic bottle). Slowly turn cap counterclockwise (left) until pressure begins to release.
3. Step back while the pressure releases.
4. When you are sure that all the pressure has been released, use the cloth to turn it counterclockwise and remove the cap.
5. Fill the coolant reservoir slowly with the proper coolant mixture (see above), to within the “COLD FILL RANGE” or the “FULL COLD” level on the reservoir. If you removed the radiator cap in an overflow system, fill the radiator until the coolant is visible and radiator is almost full.
6. Replace the cap. Turn until tightly installed (until “clicks” are heard). (Cap must be tightly installed to prevent coolant loss.)

After any coolant has been added, check the coolant concentration, refer to *Checking engine coolant* section. If the concentration is not 50/50 (protection to $-34^{\circ}\text{ F}/-36^{\circ}\text{ C}$), drain some coolant and adjust the concentration. It may take several drains and additions to obtain a 50/50 coolant concentration.

Whenever coolant has been added, the coolant level in the coolant reservoir should be checked the next few times you drive the vehicle. If necessary, add enough 50/50 concentration of engine coolant and distilled water to bring the liquid level to the proper level.

If you have to add more than 1.0 quart (1.0 liter) of engine coolant per month, have your dealer check the engine cooling system. Your cooling system may have a leak. Operating an engine with a low level of coolant can result in engine overheating and possible engine damage.

Recycled engine coolant

Ford Motor Company does NOT recommend the use of recycled engine coolant in vehicles originally equipped with Motorcraft Premium Gold Engine Coolant since a Ford-approved recycling process is not yet available.

276

2005 Explorer (exp)
Owners Guide (post-2002-fmt)
USA (fus)

Maintenance and Specifications



Used engine coolant should be disposed of in an appropriate manner. Follow your community's regulations and standards for recycling and disposing of automotive fluids.

Coolant refill capacity

To find out how much fluid your vehicle's cooling system can hold, refer to *Refill capacities* in this section.

Fill your engine coolant reservoir as outlined in *Adding engine coolant* in this section.

Severe climates

If you drive in extremely cold climates (less than -34°F [-36°C]):

- **It may be necessary to increase the coolant concentration above 50%.**
- **NEVER increase the coolant concentration above 60%.**
- **Increased engine coolant concentrations above 60% will decrease the overheat protection characteristics of the engine coolant and may cause engine damage.**
- **Refer to the chart on the coolant container to ensure the coolant concentration in your vehicle will provide adequate freeze protection at the temperatures in which you drive in the winter months.**

If you drive in extremely hot climates:

- **It is still necessary to maintain the coolant concentration above 40%.**
- **NEVER decrease the coolant concentration below 40%.**
- **Decreased engine coolant concentrations below 40% will decrease the corrosion protection characteristics of the engine coolant and may cause engine damage.**
- **Decreased engine coolant concentrations below 40% will decrease the freeze protection characteristics of the engine coolant and may cause engine damage.**
- **Refer to the chart on the coolant container to ensure the coolant concentration in your vehicle will provide adequate protection at the temperatures in which you drive.**

Vehicles driven year-round in non-extreme climates should use a 50/50 mixture of engine coolant and distilled water for optimum cooling system and engine protection.

Maintenance and Specifications

What you should know about fail-safe cooling (4.6L V8 engine only)

If the engine coolant supply is depleted, this feature allows the vehicle to be driven temporarily before incremental component damage is incurred. The “fail-safe” distance depends on ambient temperatures, vehicle load and terrain.

How fail-safe cooling works

If the engine begins to overheat:

- The engine coolant temperature gauge will move to the red (hot) area.
- HIGH TEMP LOW OIL (if equipped) or CHECK GAUGE (if equipped) will illuminate.
- The *Service engine soon* indicator light will illuminate.

If the engine reaches a preset over-temperature condition, the engine will automatically switch to alternating cylinder operation. Each disabled cylinder acts as an air pump and cools the engine.

When this occurs the vehicle will still operate. However:

- The engine power will be limited.
- The air conditioning system will be disabled.

Continued operation will increase the engine temperature:

- The engine will completely shut down.
- Steering and braking effort will increase.

Once the engine temperature cools, the engine can be re-started. Take your vehicle to a service facility as soon as possible to minimize engine damage.

When fail-safe mode is activated

You have limited engine power when in the fail-safe mode, so drive the vehicle with caution. The vehicle will not be able to maintain high speed operation and the engine will run rough. Remember that the engine is capable of completely shutting down automatically to prevent engine damage, therefore:

1. Pull off the road as soon as safely possible and turn off the engine.
2. Arrange for the vehicle to be taken to a service facility.
3. If this is not possible, wait a short period for the engine to cool.
4. Check the coolant level and replenish if low.

278

2005 Explorer (exp)
Owners Guide (post-2002-fmt)
USA (fus)

Maintenance and Specifications



Never remove the coolant reservoir cap while the engine is running or hot.

5. Restart the engine and take your vehicle to a service facility.

Driving the vehicle without repairing the engine problem increases the chance of engine damage. Take your vehicle to a service facility as soon as possible.

WHAT YOU SHOULD KNOW ABOUT AUTOMOTIVE FUELS

Important safety precautions



Do not overfill the fuel tank. The pressure in an overfilled tank may cause leakage and lead to fuel spray and fire.



The fuel system may be under pressure. If the fuel filler cap is venting vapor or if you hear a hissing sound, wait until it stops before completely removing the fuel filler cap. Otherwise, fuel may spray out and injure you or others.



If you do not use the proper fuel filler cap, excessive pressure or vacuum in the fuel tank may damage the fuel system or cause the fuel cap to disengage in a collision, which may result in possible personal injury.



Automotive fuels can cause serious injury or death if misused or mishandled.



Gasoline may contain benzene, which is a cancer-causing agent.

Observe the following guidelines when handling automotive fuel:

Maintenance and Specifications

- Extinguish all smoking materials and any open flames before refueling your vehicle.
- Always turn off the vehicle before refueling.
- Automotive fuels can be harmful or fatal if swallowed. Fuel such as gasoline is highly toxic and if swallowed can cause death or permanent injury. If fuel is swallowed, call a physician immediately, even if no symptoms are immediately apparent. The toxic effects of fuel may not be visible for hours.
- Avoid inhaling fuel vapors. Inhaling too much fuel vapor of any kind can lead to eye and respiratory tract irritation. In severe cases, excessive or prolonged breathing of fuel vapor can cause serious illness and permanent injury.
- Avoid getting fuel liquid in your eyes. If fuel is splashed in the eyes, remove contact lenses (if worn), flush with water for 15 minutes and seek medical attention. Failure to seek proper medical attention could lead to permanent injury.
- Fuels can also be harmful if absorbed through the skin. If fuel is splashed on the skin and/or clothing, promptly remove contaminated clothing and wash skin thoroughly with soap and water. Repeated or prolonged skin contact with fuel liquid or vapor causes skin irritation.
- Be particularly careful if you are taking “Antabuse” or other forms of disulfiram for the treatment of alcoholism. Breathing gasoline vapors, or skin contact could cause an adverse reaction. In sensitive individuals, serious personal injury or sickness may result. If fuel is splashed on the skin, promptly wash skin thoroughly with soap and water. Consult a physician immediately if you experience an adverse reaction.



 When refueling always shut the engine off and never allow sparks or open flames near the filler neck. Never smoke while refueling. Fuel vapor is extremely hazardous under certain conditions. Care should be taken to avoid inhaling excess fumes.

 The flow of fuel through a fuel pump nozzle can produce static electricity, which can cause a fire if fuel is pumped into an ungrounded fuel container.

Maintenance and Specifications

Refueling



Fuel vapor burns violently and a fuel fire can cause severe injuries. To help avoid injuries to you and others:

- Read and follow all the instructions on the pump island;
- Turn off your engine when you are refueling;
- Do not smoke if you are near fuel or refueling your vehicle;
- Keep sparks, flames and smoking materials away from fuel;
- Stay outside your vehicle and do not leave the fuel pump unattended when refueling your vehicle — this is against the law in some places;
- Keep children away from the fuel pump; never let children pump fuel

Use the following guidelines to avoid static build-up when filling an ungrounded fuel container:

- Place approved fuel container on the ground.
- DO NOT fill a fuel container while it is in the vehicle (including the cargo area).
- Keep the fuel pump nozzle in contact with the fuel container while filling.
- DO NOT use a device that would hold the fuel pump handle in the fill position.

Choosing the right fuel

If your vehicle is a flexible fuel vehicle (FFV), use only UNLEADED FUEL and FUEL ETHANOL (Ed75–Ed85)

Your vehicle was not designed to use fuel or fuel additives with metallic compounds, including manganese-based additives. Studies indicate that these additives can cause your vehicle's emission control system to deteriorate more rapidly. In Canada, premium grade fuel generally contains more metallic additives than regular fuel. We recommend using regular grade fuel. In Canada, many fuels contain metallic additives, but fuels free of such additives may be available; check with your local fuel dealer.

Do not use fuel containing methanol. It can damage critical fuel system components.

Repairs to correct the effects of using a fuel for which your vehicle was not designed may not be covered by your warranty.

Maintenance and Specifications

Octane recommendations

Do not be concerned if your engine sometimes knocks lightly. However, if it knocks heavily under most driving conditions while you are using fuel with the recommended octane rating, see your dealer or a qualified service technician to prevent any engine damage.

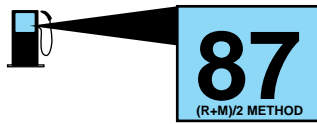

Unleaded Gasoline engines

Your vehicle is designed to use “Regular” unleaded gasoline with an (R+M)/2 octane rating of 87. We do not recommend the use of gasolines labeled as “Regular” that are sold with octane ratings of 86 or lower in high altitude areas.

FFV engine (if equipped)

Your vehicle is designed to use Fuel Ethanol (Ed75–Ed85), “Regular” unleaded gasoline or any mixture of the two fuels.

U.S. government regulations require fuel ethanol dispensing pumps to have a small, square, orange and black label with the common abbreviation or the appropriate percentage for that region. Use of other fuels such as Fuel Methanol may cause powertrain damage, a loss of vehicle performance, and your warranty may be invalidated.

Fuel quality

Many of the world’s automakers approved the World-wide Fuel Charter that recommends gasoline specifications to provide improved performance and emission control system protection for your vehicle. Gasolines that meet the World-wide Fuel Charter should be used when available. Ask your fuel supplier about gasolines that meet the World-wide Fuel Charter.

It should not be necessary to add any aftermarket products to your fuel tank if you continue to use high quality fuel of the recommended octane rating. Aftermarket products could cause damage to the fuel system. Repairs to correct the effects of using an aftermarket product in your fuel may not be covered by your warranty.

Unleaded Gasoline engines

If you are experiencing starting, rough idle or hesitation driveability problems during a cold start, try a different brand of “Regular” unleaded gasoline. “Premium” unleaded gasoline is not recommended (particularly

282

*2005 Explorer (exp)
Owners Guide (post-2002-fmt)
USA (fus)*

Maintenance and Specifications

in the United States) because it may cause these problems to become more pronounced. If the problems persist, see your dealer or a qualified service technician.

FFV engine (if equipped)

Your FFV will operate well on ordinary "Regular" unleaded gasoline, but only the highest quality fuel ethanol will provide the same level of protection and performance. To identify if your vehicle is an FFV, check your VIN or the label on the inside of your fuel filler door. When checking the VIN, look for the engine type identifier (8th character). If your vehicle is an FFV, then the character will be labeled as a "K."

If you operate your vehicle 50% or more of the time on ethanol, you should follow a different maintenance schedule. See the *Scheduled Maintenance Guide* for more information.

If you are experiencing a rough or rolling idle after start-up with the outside temperature above 80° F (27° C), the idle should improve within 10 to 30 seconds. If the problems persist below this temperature, see your dealer or a qualified service technician.

Cleaner air

Ford endorses the use of reformulated "cleaner-burning" gasolines to improve air quality.

Running out of fuel

Avoid running out of fuel because this situation may have an adverse affect on powertrain components.

If you have run out of fuel:

- You may need to cycle the ignition from OFF to ON several times after refueling, to allow the fuel system to pump the fuel from the tank to the engine.

Fuel Filler Cap

Your fuel tank filler cap has an indexed design with a 1/4 turn on/off feature.

When fueling your vehicle:

1. Turn the engine off.
2. Carefully turn the filler cap counterclockwise 1/4 of a turn until it stops.
3. Pull to remove the cap from the fuel filler pipe.

Maintenance and Specifications

4. To install the cap, align the tabs on the cap with the notches on the filler pipe.

5. Turn the filler cap clockwise 1/4 of a turn until it clicks at least once.

If the "Check Fuel Cap" indicator comes on and stays on after you start the engine, the fuel filler cap may not be properly installed. Turn off the engine, remove the fuel filler cap, align the cap properly and reinstall it.

If you must replace the fuel filler cap, replace it with a fuel filler cap that is designed for your vehicle. The customer warranty may be void for any damage to the fuel tank or fuel system if the correct genuine Ford or Motorcraft fuel filler cap is not used.



The fuel system may be under pressure. If the fuel filler cap is venting vapor or if you hear a hissing sound, wait until it stops before completely removing the fuel filler cap. Otherwise, fuel may spray out and injure you or others.



If you do not use the proper fuel filler cap, excessive pressure or vacuum in the fuel tank may damage the fuel system or cause the fuel cap to disengage in a collision, which may result in possible personal injury.

Fuel Filter

For fuel filter replacement, see your dealer or a qualified service technician. Refer to *scheduled maintenance information* for the appropriate intervals for changing the fuel filter.

Replace the fuel filter with an authorized Motorcraft part. The customer warranty may be void for any damage to the fuel system if an authorized Motorcraft fuel filter is not used.

ESSENTIALS OF GOOD FUEL ECONOMY

Measuring techniques

Your best source of information about actual fuel economy is you, the driver. You must gather information as accurately and consistently as possible. Fuel expense, frequency of fill-ups or fuel gauge readings are NOT accurate as a measure of fuel economy. We do not recommend taking fuel economy measurements during the first 1,000 miles (1,600 km) of driving (engine break-in period). You will get a more accurate measurement after 2,000 miles-3,000 miles (3,000 km-5,000 km).

284

2005 Explorer (exp)
Owners Guide (post-2002-fmt)
USA (fus)

Maintenance and Specifications

Filling the tank

The advertised fuel capacity of the fuel tank on your vehicle is equal to the rated refill capacity of the fuel tank as listed in the *Refill capacities* section of this chapter.

The advertised capacity is the amount of the indicated capacity and the empty reserve combined. Indicated capacity is the difference in the amount of fuel in a full tank and a tank when the fuel gauge indicates empty. Empty reserve is the small amount of fuel remaining in the fuel tank after the fuel gauge indicates empty.

The amount of usable fuel in the empty reserve varies and should not be relied upon to increase driving range. When refueling your vehicle after the fuel gauge indicates empty, you might not be able to refuel the full amount of the advertised capacity of the fuel tank due to the empty reserve still present in the tank.

For consistent results when filling the fuel tank:

- Turn the engine/ignition switch to the off position prior to refueling, an error in the reading will result if the engine is left running.
- Use the same filling rate setting (low — medium — high) each time the tank is filled.
- Allow no more than two automatic click-offs when filling.
- Always use fuel with the recommended octane rating.
- Use a known quality gasoline, preferably a national brand.
- Use the same side of the same pump and have the vehicle facing the same direction each time you fill up.
- Have the vehicle loading and distribution the same every time.

Your results will be most accurate if your filling method is consistent.

Filling the tank for FFV equipped vehicles

Your vehicle will operate on both unleaded gasoline with an octane rating of 87, or E-85 fuel, or any mixture of these two. For best results it is recommended that you do not add less than five gallons of fuel when refueling. Observing this precaution will avoid possible hard starting and/or deterioration in drivability during warm up.

Calculating fuel economy

1. Fill the fuel tank completely and record the initial odometer reading (in miles or kilometers).
2. Each time you fill the tank, record the amount of fuel added (in gallons or liters).

Maintenance and Specifications

3. After at least three to five tank fill-ups, fill the fuel tank and record the current odometer reading.
4. Subtract your initial odometer reading from the current odometer reading.
5. Follow one of the simple calculations in order to determine fuel economy:

Calculation 1: **Divide total miles traveled by total gallons used.**

Calculation 2: **Multiply liters used by 100, then divide by total kilometers traveled.**

Keep a record for at least one month and record the type of driving (city or highway). This will provide an accurate estimate of the vehicle's fuel economy under current driving conditions. Additionally, keeping records during summer and winter will show how temperature impacts fuel economy. In general, lower temperatures give lower fuel economy.

Driving style — good driving and fuel economy habits

Give consideration to the lists that follow and you may be able to change a number of variables and improve your fuel economy.

Habits

- Smooth, moderate operation can yield up to 10% savings in fuel.
- Steady speeds without stopping will usually give the best fuel economy.
- Idling for long periods of time (greater than one minute) may waste fuel.
- Anticipate stopping; slowing down may eliminate the need to stop.
- Sudden or hard accelerations may reduce fuel economy.
- Slow down gradually.
- Driving at reasonable speeds (traveling at 55 mph [88 km/h] uses 15% less fuel than traveling at 65 mph [105 km/h]).
- Revving the engine before turning it off may reduce fuel economy.
- Using the air conditioner or defroster may reduce fuel economy.
- You may want to turn off the speed control in hilly terrain if unnecessary shifting between third and fourth gear occurs. Unnecessary shifting of this type could result in reduced fuel economy.
- Warming up a vehicle on cold mornings is not required and may reduce fuel economy.

286

*2005 Explorer (exp)
Owners Guide (post-2002-fmt)
USA (fus)*

Maintenance and Specifications

- Resting your foot on the brake pedal while driving may reduce fuel economy.
- Combine errands and minimize stop-and-go driving.

Maintenance

- Keep tires properly inflated and use only recommended size.
- Operating a vehicle with the wheels out of alignment will reduce fuel economy.
- Use recommended engine oil. Refer to *Lubricant specifications* in this chapter.
- Perform all regularly scheduled maintenance items. Follow the recommended maintenance schedule and owner maintenance checks found in *scheduled maintenance information*.

Conditions

- Heavily loading a vehicle or towing a trailer may reduce fuel economy at any speed.
- Carrying unnecessary weight may reduce fuel economy (approximately 1 mpg [0.4 km/L] is lost for every 400 lb [180 kg] of weight carried).
- Adding certain accessories to your vehicle (for example bug deflectors, rollbars/light bars, running boards, ski/luggage racks) may reduce fuel economy.
- Fuel economy may decrease with lower temperatures during the first 8–10 miles (12–16 km) of driving.
- Driving on flat terrain offers improved fuel economy as compared to driving on hilly terrain.
- Transmissions give their best fuel economy when operated in the top cruise gear and with steady pressure on the gas pedal.
- Four-wheel-drive operation (if equipped) is less fuel efficient than two-wheel-drive operation.
- Close windows for high speed driving.

Flex fuel (E-85) cruising range

Because E-85 fuel contains less energy per gallon than gasoline, you will experience an increase in fuel consumption. You can expect your Miles Per Gallon (MPG) and your driving range to decrease by about 30% compared to gasoline operation.

EPA window sticker

Every new vehicle should have the EPA window sticker. Contact your dealer if the window sticker is not supplied with your vehicle. The EPA window sticker should be your guide for the fuel economy comparisons with other vehicles.

Maintenance and Specifications

It is important to note the box in the lower left corner of the window sticker. These numbers represent the Range of MPG (L/100 km) expected on the vehicle under optimum conditions. Your fuel economy may vary depending upon the method of operation and conditions.

EMISSION CONTROL SYSTEM

Your vehicle is equipped with various emission control components and a catalytic converter which will enable your vehicle to comply with applicable exhaust emission standards. To make sure that the catalytic converter and other emission control components continue to work properly:

- Use only the specified fuel listed.
- Avoid running out of fuel.
- Do not turn off the ignition while your vehicle is moving, especially at high speeds.
- Have the items listed in *scheduled maintenance information* performed according to the specified schedule.

The scheduled maintenance items listed in *scheduled maintenance information* are essential to the life and performance of your vehicle and to its emissions system.

If other than Ford, Motorcraft or Ford-authorized parts are used for maintenance replacements or for service of components affecting emission control, such non-Ford parts should be equivalent to genuine Ford Motor Company parts in performance and durability.



Do not park, idle, or drive your vehicle in dry grass or other dry ground cover. The emission system heats up the engine compartment and exhaust system, which can start a fire.

Illumination of the “Check Engine” light, charging system warning light or the temperature warning light, fluid leaks, strange odors, smoke or loss of engine power, could indicate that the emission control system is not working properly.



Exhaust leaks may result in entry of harmful and potentially lethal fumes into the passenger compartment.

Do not make any unauthorized changes to your vehicle or engine. By law, vehicle owners and anyone who manufactures, repairs, services, sells, leases, trades vehicles, or supervises a fleet of vehicles are not

Maintenance and Specifications

permitted to intentionally remove an emission control device or prevent it from working. Information about your vehicle's emission system is on the Vehicle Emission Control Information Decal located on or near the engine. This decal identifies engine displacement and gives some tune up specifications.

Please consult your *Warranty Guide* for complete emission warranty information.

On board diagnostics (OBD-II)

Your vehicle is equipped with a computer that monitors the engine's emission control system. This system is commonly known as the On Board Diagnostics System (OBD-II). This OBD-II system protects the environment by ensuring that your vehicle continues to meet government emission standards. The OBD-II system also assists the service technician in properly servicing your vehicle. When the *Check engine/Service engine soon* light illuminates, the OBD-II system has detected a malfunction. Temporary malfunctions may cause your *Check engine/Service engine soon* light to illuminate. Examples are:

1. The vehicle has run out of fuel. (The engine may misfire or run poorly.)
2. Poor fuel quality or water in the fuel.
3. The fuel cap may not have been securely tightened. See *Fuel filler cap* in this chapter.

These temporary malfunctions can be corrected by filling the fuel tank with good quality fuel and/or properly tightening the fuel cap. After three driving cycles without these or any other temporary malfunctions present, the *Check engine/Service engine soon* light should turn off. (A driving cycle consists of a cold engine startup followed by mixed city/highway driving.) No additional vehicle service is required.

If the *Check engine/Service engine soon* light remains on, have your vehicle serviced at the first available opportunity.

Readiness for Inspection/Maintenance (I/M) testing

In some localities, it may be a legal requirement to pass an I/M test of the on-board diagnostics system. If your *Check engine/Service engine soon* light is on, refer to the description in the *Warning lights and chimes* section of the *Instrument Cluster* chapter. Your vehicle may not pass the I/M test with the *Check engine/Service engine soon* light on.

Maintenance and Specifications

If the vehicle's powertrain system or its battery has just been serviced, the on-board diagnostics system is reset to a "not ready for I/M test" condition. To ready the on-board diagnostics system for I/M testing, a minimum of 30 minutes of city and highway driving is necessary as described below:

- First, at least 10 minutes of driving on an expressway or highway.
- Next, at least 20 minutes driving in stop-and-go, city-type traffic with at least four idle periods.

Allow the vehicle to sit for at least eight hours without starting the engine. Then, start the engine and complete the above driving cycle. The engine must warm up to its normal operating temperature. Once started, do not turn off the engine until the above driving cycle is complete.

POWER STEERING FLUID

Check the power steering fluid. Refer to the scheduled maintenance guide for the service interval schedules. If adding fluid is necessary, use only MERCON® ATF.

- 4.0L SOHC V6 engine

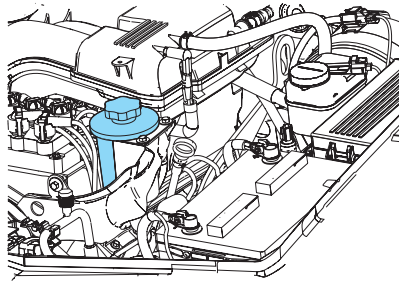

- 4.6L V8 engine

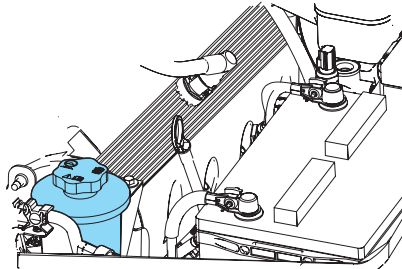

1. Start the engine and let it run until it reaches normal operating temperature (the engine coolant temperature gauge indicator will be near the center of the normal area between H and C).

290

2005 Explorer (exp)
Owners Guide (post-2002-fmt)
USA (fus)

Maintenance and Specifications

2. While the engine idles, turn the steering wheel left and right several times.
3. Turn the engine off.
4. Check the fluid level in the reservoir.
5. The fluid level should be between the MIN and MAX lines. Do not add fluid if the level is in this range.
6. If the fluid is low, add fluid in small amounts, continuously checking the level until it reaches the correct operating range. Be sure to put the cap back on the reservoir.

BRAKE FLUID

The fluid level will drop slowly as the brakes wear, and will rise when the brake components are replaced. Fluid levels below the “MAX” line that do not trigger the brake system warning lamp are within the normal operating range, there is no need to add fluid. If the fluid levels are outside of the normal operating range, the performance of your brake system could be compromised, seek service from your dealer immediately.

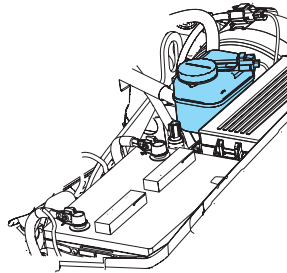

TRANSMISSION FLUID

Checking automatic transmission fluid

The automatic transmission does not have a transmission fluid dipstick.

Refer to your *scheduled maintenance information* for scheduled intervals for fluid checks and changes. Your transmission does not consume fluid. However, the fluid level should be checked if the transmission is not working properly, (i.e., if the transmission slips or shifts slowly) or if you notice some sign of fluid leakage.

Transmission fluid should be checked and, if required, fluid should be added by a qualified technician.

Do not use supplemental transmission fluid additives, treatments or cleaning agents. The use of these materials may affect transmission operation and result in damage to internal transmission components.

Maintenance and Specifications

AIR FILTER

Refer to *scheduled maintenance information* for the appropriate intervals for changing the air filter element.

When changing the air filter element, use only the Motorcraft air filter element listed. Refer to *Motorcraft part numbers* in this chapter.

Note: Do not start your engine with the air cleaner removed and do not remove it while the engine is running.

Changing the air filter element

1. Release the clamps that secure the air filter housing cover.
2. Carefully separate the two halves of the air filter housing.
3. Remove the air filter element from the air filter housing.
4. Wipe the air filter housing and cover clean to remove any dirt or debris and to ensure good sealing.
5. Install a new air filter element. Be careful not to crimp the filter element edges between the air filter housing and cover. This could cause filter damage and allow unfiltered air to enter the engine if not properly seated.
6. Replace the air filter housing cover and secure the clamps.

Note: Failure to use the correct air filter element may result in severe engine damage. The customer warranty may be voided for any damage to the engine if the correct air filter element is not used.

Maintenance and Specifications

TRANSFER CASE FLUID (IF EQUIPPED)

1. Clean the filler plug.
2. Remove the filler plug and inspect the fluid level.

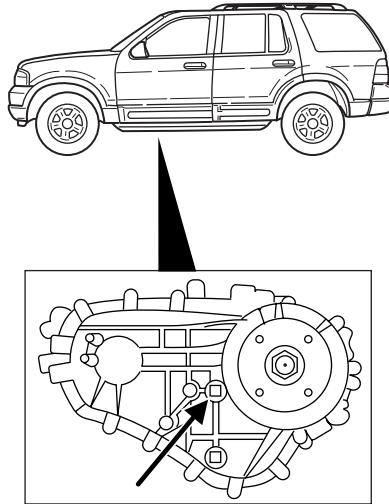

3. Add only enough fluid through the filler opening so that the fluid level is at the bottom of the opening.

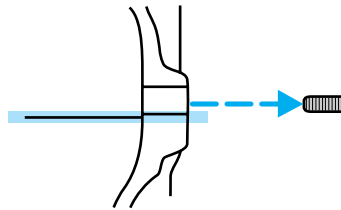

Use only fluid that meets Ford specifications. Refer to *Lubricant specifications* in this chapter.

DRIVELINE UNIVERSAL JOINT AND SLIP YOKE

Your vehicle may be equipped with universal joints that require lubrication. Refer to the *scheduled maintenance information* for maintenance intervals. If the original universal joints are replaced with universal joints equipped with grease fittings, lubrication will also be necessary.

Maintenance and Specifications

MOTORCRAFT PART NUMBERS

Component	4.0L SOHC V6 engine	4.6L V8 engine
Air filter element	FA-1695	FA-1695
Fuel filter	2C5E-9155-BB	2C5E-9155-BB
Battery	BXT-65-650	BXT-65-650
Oil filter	FL-820S	FL-820S
PCV valve	¹	
Spark plugs	²	

¹The PCV valve is a critical emission component. It is one of the items listed in *scheduled maintenance information* and is essential to the life and performance of your vehicle and to its emissions system.

For PCV valve replacement, see your dealer or a qualified service technician. Refer to *scheduled maintenance information* for the appropriate intervals for changing the PCV valve.

Replace the PCV valve with one that meets Ford material and design specifications for your vehicle, such as a Motorcraft or equivalent replacement part. The customer warranty may be void for any damage to the emissions system if such a PCV valve is not used.

²For spark plug replacement, see your dealer or a qualified service technician. Refer to *scheduled maintenance information* for the appropriate intervals for changing the spark plugs.

Replace the spark plugs with ones that meet Ford material and design specifications for your vehicle, such as Motorcraft or equivalent replacement parts. The customer warranty may be void for any damage to the engine if such spark plugs are not used.

Maintenance and Specifications

REFILL CAPACITIES

Fluid	Ford Part Name	Application	Capacity
Brake fluid	Motorcraft High Performance DOT 3 Motor Vehicle Brake Fluid	All	Fill to line on reservoir
Engine oil (including filter change) ⁵	Motorcraft SAE 5W-30 Premium Synthetic Blend Motor Oil (US) Motorcraft SAE 5W-30 Super Premium Motor Oil (Canada)	4.0L	5.0 quarts (4.7L)
	Motorcraft SAE 5W-20 Premium Synthetic Blend Motor Oil (US) Motorcraft SAE 5W-20 Super Premium Motor Oil (Canada)	4.6L	6.0 quarts (5.7L)
Fuel tank	N/A	All	22.5 gallons (85.2L)
Power steering fluid	Motorcraft MERCON® ATF	All	Fill between the MIN and MAX lines on reservoir
Transmission fluid ¹	Motorcraft MERCON® V ATF	Automatic transmissions	12.7 quarts (12.0L) ²
Transfer case	Motorcraft MERCON® ATF	4WD	1.5 quarts (1.4L)

Maintenance and Specifications

Fluid	Ford Part Name	Application	Capacity
Engine coolant ³	Motorcraft Premium Gold Engine Coolant (yellow-colored)	4.0L SOHC V6 engine without auxiliary climate control	16.3 quarts (15.4L)
		4.0L SOHC V6 engine with auxiliary climate control	18.2 quarts (17.2L)
		4.6L V8 engine without auxiliary climate control	18.6 quarts (17.6L)
		4.6L V8 engine with auxiliary climate control	20.1 quarts (19.0L)
Front axle lubricant	Motorcraft SAE 80W-90 Premium Rear Axle Lubricant	4x4 vehicles	1.8 quarts (1.7L)
Rear axle lubricant	Motorcraft SAE 75W-140 Synthetic Rear Axle Lubricant	Conventional Axle	3.5 pints (1.7L)
		Limited slip axle ⁴	3.25 pints (1.5L)
Windshield washer fluid	Motorcraft Premium Windshield Washer Concentrate	All	4.2 quarts (4.0L)

¹Ensure the correct automatic transmission fluid is used. MERCON® and MERCON® V are not interchangeable. DO NOT mix MERCON® and MERCON® V. Refer to your *scheduled maintenance information* to determine the correct service interval.

Maintenance and Specifications

²Indicates only approximate dry-fill capacity. Some applications may vary based on cooler size and if equipped with an in-tank cooler. The amount of transmission fluid and fluid level should be checked by a qualified technician.

³Add the coolant type originally equipped in your vehicle.

⁴Limited Slip differentials must add 4 oz (118 ml) of Additive Friction Modifier XL-3 or equivalent to the rear axle whenever the axle has been serviced.

⁵Use of synthetic or synthetic blend motor oil is not mandatory. Engine oil need only have the API Certification mark and meet the requirements of Ford specification WSS-M2C929-A (4.0L) or WSS-M2C930-A (4.6L).

LUBRICANT SPECIFICATIONS

Item	Ford Part Name or equivalent	Ford Part Number	Ford Specification
Body hinges, latches, door striker plates and rotors, seat tracks, fuel filler door hinge and spring, hood latch, auxiliary latch, seat tracks	Multi-Purpose Grease or Multi-Purpose Grease Spray	XG-4 or XL-5	ESB-M1C93-B
Hydraulic brake fluid and Clutch Fluid (if equipped)	Motorcraft High Performance DOT 3 Motor Vehicle Brake Fluid	PM-1	ESA-M6C25-A or WSS-M6C62-A
Driveshaft, slip spline, universal joints	Premium Long Life Grease	XG-1-C or XG-1-K	ESA-M1C75-B

Maintenance and Specifications

Item	Ford Part Name or equivalent	Ford Part Number	Ford Specification
Engine coolant	Motorcraft Premium Gold Engine Coolant (yellow-colored)	VC-7-A (U.S., except CA, OR and NM), VC-7-B (CA, OR and NM)	WSS-M97B51-A1
4.0L Engine oil	Motorcraft SAE 5W-30 Premium Synthetic Blend Motor Oil (US) Motorcraft SAE 5W-30 Super Premium Motor Oil (Canada)	XO-5W30-QSP (US) CXO-5W30-LSP12 (Canada)	WSS-M2C929-A with API Certification Mark
4.6L Engine oil	Motorcraft SAE 5W20 Premium Synthetic Blend Motor Oil (US) Motorcraft SAE 5W-20 Super Premium Motor Oil (Canada)	XO -5W20-QSP (US) CXO-5W20-LSP12 (Canada)	WSS-M2C930-A with API Certification Mark
Automatic transmission ¹	Motorcraft MERCON®V ATF	XT-5-QM	MERCON®V
Power steering fluid	Motorcraft MERCON® Multi-Purpose ATF	XT-2-QDX	MERCON®
Rear axles	75W-140 High Performance Synthetic Rear Axle Lubricant ²	XY-75W140-QL	WSL-M2C192_A

Maintenance and Specifications

Item	Ford Part Name or equivalent	Ford Part Number	Ford Specification
Front axle (4X4)	Motorcraft SAE 80W-90 Premium Rear Axle Lubricant	XY-80W90-QL	WSP-M2C197-A
Transfer case (4X4)	Motorcraft MERCON® Multi-Purpose ATF	XT-2-QDX	MERCON®
Transfer case Front Output Slip Shaft	Premium Long-Life Grease	XG-1-C or XG-1-K	ESA-M1C75-B
Windshield washer fluid	Motorcraft Premium Windshield Washer Concentrate	ZC-32-A	WSB-M8B16-A2

¹Ensure the correct automatic transmission fluid is used. MERCON® and MERCON® V are not interchangeable. DO NOT mix MERCON® and MERCON® V. Refer to your *scheduled maintenance information* to determine the correct service interval.

²Limited slip differentials must add 4 oz (118 ml) of Additive Friction Modifier XL-3 or equivalent to the rear axle whenever the axle has been serviced.

ENGINE DATA

Engine	4.0L SOHC V6 engine	4.6L V8 engine
Cubic inches	245	281
Required fuel	87 octane	87 octane
Firing order	1-4-2-5-3-6	1-3-7-2-6-5-4-8
Ignition system	EDIS	EDIS

Maintenance and Specifications

Engine	4.0L SOHC V6 engine	4.6L V8 engine
Spark plug gap	0.051–0.056 inch (1.32–1.42mm)	0.052–0.056 inch (1.32–1.42 mm)
Compression ratio	9.7:1	9.4:1

VEHICLE DIMENSIONS

Dimensions	4-Door 4x2 or 4x4 XLT Model - Inches (mm)
(1) Overall length	191.6 (4866.7)
(2) Overall width	73.7 (1870.9)
(2) Overall width including outside mirrors	83.9 (2130.8)
(3) Maximum height	70.0 (1777.5)
(3) Maximum height* with crossbar	71.9 (1825.4)
(4) Wheelbase	113.7 (2889)
(5) Track width, front	60.9 (1547)
(5) Track width, rear	61.3 (1556.5)

* Height includes roof rack and P255/70R16 tire

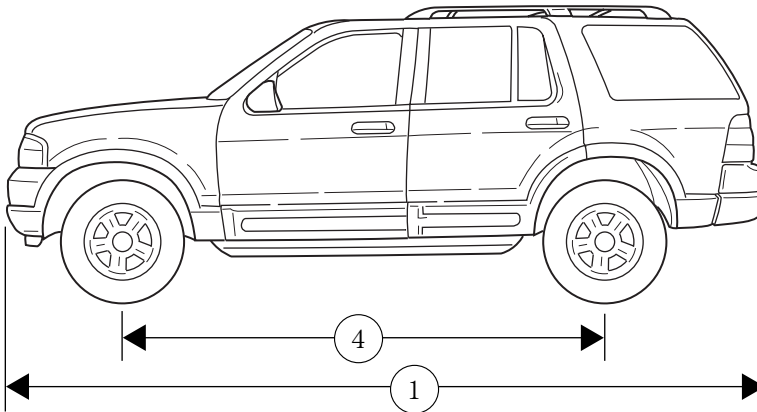

Maintenance and Specifications

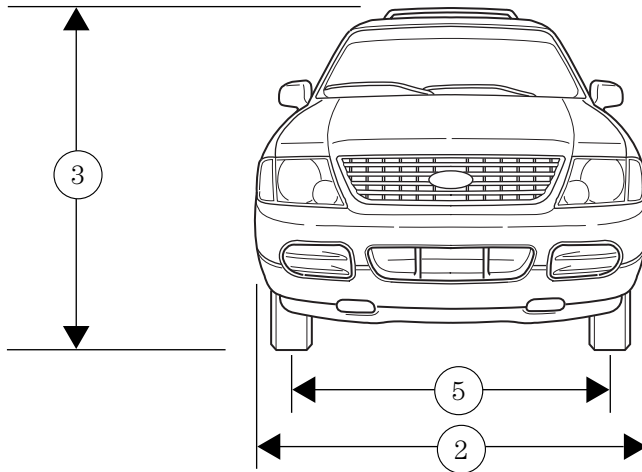

IDENTIFYING YOUR VEHICLE

Certification label

The National Highway Traffic Safety Administration Regulations require that a Safety Compliance Certification Label be affixed to a vehicle and prescribe where the Safety Compliance Certification Label may be located. The Safety Compliance Certification Label is located on the structure by the trailing edge of the driver's door or the edge of the driver's door.

MFD. BY FORD MOTOR CO. IN U.S.A.					
DATE: XX/XX	GVWR: XXXXLB/ XXXXKG				
FRONT GAWR: XXXXL	REAR GAWR: XXXXLB				
XXXXKG	WITH	XXXXKG	WITH		
XXXX/XXXXXXXX	TIRES	XXXX/XXXXXXXX	TIRES		
XXXX.XX	RIMS	XXXX.XX	RIMS		
AT XXX kPa/XX	PSI COLD	AT XXX kPa/XX	PSI COLD		
THIS VEHICLE CONFORMS TO ALL APPLICABLE FEDERAL MOTOR VEHICLE SAFETY AND THEFT PREVENTION STANDARDS IN EFFECT ON THE DATE OF MANUFACTURE SHOWN ABOVE.					
VIN: XXXXXXXXXXXXXXXXX	XXXXX		XXXXX		
TYPE: XXX					
EXT PNT: XX	RC: XX	DSO:			
WB ¹ BRK ² INT TR ³ TP/PS ⁴ R ⁵ AXLE ⁶ TR ⁷ SPR ⁸ XXXXX					
XXX X XX X XX X XX XXX					
XXXXXXXXXXXXX UTC V2USA-1520472-AA					

Maintenance and Specifications

Vehicle identification number

The vehicle identification number (VIN) is a 17 digit combination of letters and numbers. The VIN is attached to a metal tag and is located on the driver side instrument panel. The VIN number is also found on the Certification label. (Please note that in the graphic XXXX is representative of your vehicle identification number.)

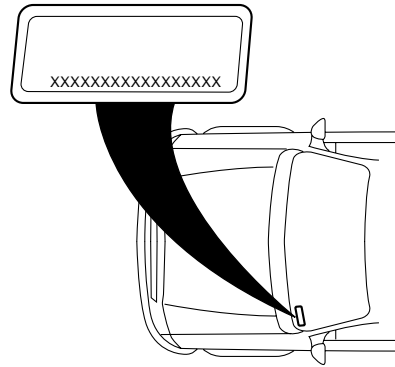

1. World manufacturer identifier
2. Brake type and gross vehicle weight rating (GVWR)
3. Vehicle line, series, body type
4. Engine type
5. Check digit
6. Model year
7. Assembly plant
8. Production sequence number

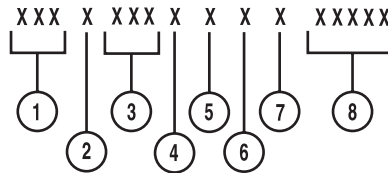

Engine number

The engine number (the last eight numbers of the vehicle identification number) is stamped on the engine block, transmission, frame and transfer case (if equipped).

Maintenance and Specifications

Transmission/Transaxle code designations

You can find a transmission/transaxle code on the Safety Compliance Certification Label. The following table tells you which transmission or transaxle each code represents.

MFD. BY FORD MOTOR CO. IN U.S.A.					
DATE: XX/XX	GVWR: XXXXXLB/ XXXXXKG				
FRONT GAWR: XXXXL	REAR GAWR: XXXXLB				
XXXXKG	WITH	XXXXKG	WITH		
XXXX/XXXXXXXX	TIRES	XXXX/XXXXXXXX	TIRES		
XXXX.XX	RIMS	XXXX.XX	RIMS		
AT XXX kPa/XX	PSI COLD	AT XXX kPa/XX	PSI COLD		
THIS VEHICLE CONFORMS TO ALL APPLICABLE FEDERAL MOTOR VEHICLE SAFETY AND THEFT PREVENTION STANDARDS IN EFFECT ON THE DATE OF MANUFACTURE SHOWN ABOVE.					
VIN: XXXXXXXXXXXXXXXXX	XXXXX		XXXXX		
TYPE: XXX					
					
EXT PNT: XX	RC: XX	DSO:			
WB ' BRK ' INT TR ' TP/PS ' R ' AXLE ' TR ' SPR ' XXXXX					
XXX X XX X XX X XX					
XXXXXXXXXXXXX UTC V2USA-1520472-AA					



Code	Description
V	Five-speed automatic (5R55S)

Accessories

GENUINE FORD ACCESSORIES FOR YOUR VEHICLE

A wide selection of Genuine Ford Accessories are available for your vehicle through your local authorized Ford or Ford of Canada dealer. These quality accessories have been specifically engineered to fulfill your automotive needs; they are custom designed to complement the style and aerodynamic appearance of your vehicle. In addition, each accessory is made from high quality materials and meets or exceeds Ford's rigorous engineering and safety specifications. Ford Motor Company will repair or replace any properly dealer-installed Genuine Ford Accessory found to be defective in factory-supplied materials or workmanship during the warranty period, as well as any component damaged by the defective accessory. The accessory will be warranted for whichever provides you the greatest benefit:

- 12 months or 12,000 miles (20,000 km) (whichever occurs first), or
- the remainder of your new vehicle limited warranty.

This means that Genuine Ford Accessories purchased along with your new vehicle and installed by the dealer are covered for the full length of your New Vehicle's Limited Warranty — 3 years or 36,000 miles (60,000 km) (whichever occurs first). Contact your dealer for details and a copy of the warranty.

Not all accessories are available for all models.

The following is a list of several Genuine Ford Accessory products. Not all accessories are available for all models. For a complete listing of the accessories that are available for your vehicle, please contact your dealer or visit our online store at: www.fordaccessoriesstore.com.

Exterior style

Bug shields

Deflectors

Fender flares

Front end covers

Grille inserts

Headlamps, fog lights and Daytime Running Lamps (DRLs)

Running boards

Splash guards

Step Bars

Wheels

304

2005 Explorer (exp)
Owners Guide (post-2002-fmt)
USA (fus)

Accessories

Interior style

Electrochromatic compass/temperature interior mirrors
Floor mats
Leather wrapped steering wheels
Scuff plates

Lifestyle

Bike racks
Cargo organization and management
Rear seat entertainment systems
Towing mirrors
Trailer hitches, wiring harnesses and accessories

Peace of mind

First aid and highway safety kits
Full vehicle covers
Locking gas cap
Navigation systems
Remote start
Vehicle security systems
Keyless entry keypad

For maximum vehicle performance, keep the following information in mind when adding accessories or equipment to your vehicle:

- When adding accessories, equipment, passengers and luggage to your vehicle, do not exceed the total weight capacity of the vehicle or of the front or rear axle (GVWR or GAWR as indicated on the Safety Compliance Certification label). Consult your dealer for specific weight information.
- The Federal Communications Commission (FCC) and Canadian Radio Telecommunications Commission (CRTC) regulate the use of mobile communications systems — such as two-way radios, telephones and theft alarms - that are equipped with radio transmitters. Any such equipment installed in your vehicle should comply with FCC or CRTC regulations and should be installed only by a qualified service technician.
- Mobile communications systems may harm the operation of your vehicle, particularly if they are not properly designed for automotive use.

Accessories

- To avoid interference with other vehicle functions, such as anti-lock braking systems, amateur radio users who install radios and antennas onto their vehicle should not locate the Amateur Radio Antennas in the area of the driver's side hood.
- Electrical or electronic accessories or components that are added to the vehicle by the dealer or the owner may adversely affect battery performance and durability.

Index

A

Accessory delay70
AdvanceTrac206
Air cleaner filter292, 294
Air conditioning48
Airbag supplemental restraint system135, 139
 and child safety seats137
 description135, 139
 disposal143
 driver airbag137, 141
 indicator light139, 142
 operation137, 141
 passenger airbag137, 141
Ambulance packages7
Antifreeze
 (see Engine coolant)273
Anti-lock brake system
 (see Brakes)204
Audio system
 (see Radio)18, 21, 25, 30, 34, 39
Automatic transmission
 driving an automatic
 overdrive212
 fluid, adding291
 fluid, checking291
 fluid, refill capacities295
 fluid, specification299
Auxiliary power point68
Axle
 lubricant specifications ..297, 299
 refill capacities295

B

Battery271
 acid, treating emergencies271

 jumping a disabled battery239
 maintenance-free271
 replacement, specifications ...294
 servicing271
BeltMinder131
Brakes203
 anti-lock204
 anti-lock brake system (ABS)
 warning light204
 fluid, checking and adding291
 fluid, refill capacities295
 fluid, specifications297, 299
 lubricant specifications ..297, 299
 parking205
 shift interlock210

C

Calculating load193
Capacities for refilling fluids295
Cargo cover96
Cell phone use66
Changing a tire164
Child safety restraints144
 child safety belts144
Child safety seats146
 attaching with tether straps ..150
 in front seat148
 in rear seat148
Cleaning your vehicle
 engine compartment256
 instrument panel258
 interior259
 interior trim258
 plastic parts257
 safety belts259
 washing255
 waxing255
 wheels256

307

Index

- wiper blades258
- Climate control (see Air conditioning or Heating)48
- Clock35
- Clock adjust
 - 6-CD in dash23, 32, 41
 - AM/FM/CD18
 - AM/FM/Tape/CD27, 35
- Compass, electronic81–82
 - calibration83
 - set zone adjustment82, 85
- Console65
 - overhead66–67
 - rear66
- Controls
 - power seat113
 - steering column74
- Coolant
 - checking and adding273
 - refill capacities277, 295
 - specifications297, 299
- Cruise control (see Speed control)72
- Customer Assistance226
 - Ford Extended Service Plan252
 - Getting assistance outside the U.S. and Canada253
 - Getting roadside assistance ...226
 - Getting the service you need246
 - Ordering additional owner's literature253
 - The Dispute Settlement Board249
 - Utilizing the Mediation/Arbitration Program251
- D**
 - Daytime running lamps (see Lamps)55
 - Defrost
 - rear window53
 - Dipstick
 - automatic transmission fluid291
 - engine oil265
 - Doors
 - lubricant specifications297
 - Driveline universal joint and slip yoke293
 - Driving under special conditions214, 219, 222
 - sand221
 - snow and ice224
 - through water222, 225
 - Dual automatic temperature control (DATC)48
 - DVD system44
- E**
 - Electronic message center83
 - Emergencies, roadside
 - jump-starting239
 - Emergency Flashers227
 - Emission control system288
 - Engine299–300
 - cleaning256
 - coolant273
 - fail-safe cooling278
 - idle speed control271
 - lubrication
 - specifications297, 299
 - refill capacities295

308

**2005 Explorer (exp)
Owners Guide (post-2002-fmt)
USA (fus)**

Index

- service points263–264
- starting after a collision227
- Engine block heater203
- Engine oil265
 - checking and adding265
 - dipstick265
 - filter, specifications269, 294
 - recommendations269
 - refill capacities295
 - specifications297, 299
- Exhaust fumes203
- F**
- Fail safe cooling278
- Floor mats95
- Fluid capacities295
- Foglamps54
- Four-Wheel Drive vehicles216
 - driving off road218
 - indicator light216
 - preparing to drive your vehicle209
- Fuel279
 - calculating fuel economy86, 284
 - cap283
 - capacity295
 - choosing the right fuel281
 - comparisons with EPA fuel economy estimates287
 - detergent in fuel283
 - filling your vehicle
 - with fuel279, 283, 285
 - filter, specifications284, 294
 - fuel pump shut-off switch227
 - improving fuel economy284
 - octane rating282, 299–300
 - quality282
 - running out of fuel283
 - safety information relating to automotive fuels279
- Fuel - flex fuel vehicle (FFV)281–282
- Fuses228, 230
- G**
- Garage door opener67
- Garage Door Opener (see Homelink wireless control system)77
- Gas cap (see Fuel cap)283
- Gas mileage (see Fuel economy)284
- Gauges14
- GAWR (Gross Axle Weight Rating)
 - calculating193
- GVWR (Gross Vehicle Weight Rating)
 - calculating193
- H**
- Hazard flashers227
- Head restraints111
- Headlamps
 - aiming56
 - bulb specifications59
 - daytime running lights55
 - flash to pass55
 - high beam55
- Heating
 - heating and air conditioning system46, 48
- Homelink wireless control system77

Index

- Hood262
- I**
- Ignition200, 299–300
- Infant seats
(see Safety seats)146
- Inspection/maintenance (I/M)
testing289
- Instrument panel
cleaning258
cluster10
- J**
- Jack164, 167
positioning164, 169
storage164, 167
- Jump-starting your vehicle239
- K**
- Keyless entry system104
autolock106
- Keys
positions of the ignition200
- L**
- Lamps
bulb replacement
specifications chart58–59
daytime running light55
fog lamps54
interior lamps58
- Liftgate95, 101
- Lights, warning and indicator10
anti-lock brakes (ABS)204
- Limited-slip axle216
- Load limits186
- Loading instructions193
- Locks
autolock106
childproof99
doors98
- Lubricant specifications ...297, 299
- Lug nuts172
- Luggage rack97
- Lumbar support,
seats113, 115–116
- M**
- Message center83–84
english/metric button89
system check button89
warning messages90
- Mirrors68, 71
automatic dimming rearview
mirror71
fold away71
heated70
side view mirrors (power)70
- Moon roof76
- Motorcraft parts260, 284, 294
- O**
- Octane rating282
- Oil (see Engine oil)265
- P**
- Parking brake205
- Parts (see Motorcraft parts)294
- Pedals (see Power adjustable
foot pedals)71
- Power adjustable foot pedals71

310

**2005 Explorer (exp)
Owners Guide (post-2002-fmt)
USA (fus)**

Index

- Power distribution box
(see Fuses)234
- Power door locks98
- Power mirrors70
- Power point68–69
- Power steering209
fluid, checking and adding290
fluid, refill capacity295
fluid, specifications297, 299
- Power Windows69
- Preparing to drive your
vehicle209
- R**
- Radio18, 21, 25, 30, 34, 39
- Rear window defroster53
- Relays228, 237
- Remote entry system100
illuminated entry104
opening the trunk101
- Reverse sensing system214
- Roadside assistance226
- Roof rack97
- S**
- Safety Belt Maintenance134
- Safety belts (see Safety
restraints)122, 125–128, 130
- Safety Canopy139, 141
- Safety defects, reporting254
- Safety restraints122, 125–130
belt minder131
extension assembly130
for adults126–128
for children143–144
- safety belt maintenance134
warning light and
chime130–131
- Safety seats for children146
- Safety Compliance
Certification Label301
- Seat belts
(see Safety restraints)122
- Seats111
child safety seats146
front seats112
heated116
memory seat101, 115
- Setting the clock
AM/FM/CD18
AM/FM/In-dash 6 CD23, 32, 41
AM/FM/Tape/CD27, 35
- Snowplowing7
- Spark plugs,
specifications294, 299–300
- Special notice
ambulance conversions7
utility-type vehicles7
- Specification chart,
lubricants297, 299
- Speed control72
- Starting a flex fuel vehicle202
- Starting your vehicle200, 202
jump starting239
- Steering wheel
controls74
tilting64
- T**
- Tilt steering wheel64

Index

- Tire Pressure Monitoring System (TPMS)
 - Driving221
 - Maintenance and Specifications182
 - Roadside Emergencies164
 - Warning Displays14, 90
 - Tires158–159, 164
 - alignment179
 - care178
 - changing164, 169
 - checking the pressure161
 - inspecting and inflating160
 - label177
 - replacing163, 169
 - rotating180
 - safety practices179
 - sidewall information173
 - snow tires and chains186
 - spare tire165, 167–168
 - terminology159
 - tire grades159
 - treadwear158, 178
 - Towing193
 - recreational towing198
 - trailer towing193
 - wrecker245
 - Transfer case
 - fluid checking293
 - Transmission210
 - brake-shift interlock (BSI)210
 - fluid, checking and adding (automatic)291
 - fluid, refill capacities295
 - lubricant specifications ..297, 299
 - Trunk101
 - Turn signal57
- V**
- Vehicle dimensions300
 - Vehicle Identification Number (VIN)302
 - Vehicle loading186
 - Ventilating your vehicle203
- W**
- Warning lights (see Lights)10
 - Washer fluid265
 - Water, Driving through225
 - Windows
 - power69
 - rear wiper/washer64
 - Windshield washer fluid and wipers63
 - checking and adding fluid265
 - liftgate reservoir265
 - replacing wiper blades64
 - Wrecker towing245