

## Table of Contents

<b>Introduction</b>	<b>4</b>
<b>Instrument Cluster</b>	<b>12</b>
Warning lights and chimes	12
Gauges	17
Message center	19
<b>Entertainment Systems</b>	<b>26</b>
AM/FM stereo	26
AM/FM stereo with CD	28
AM/FM stereo cassette with CD	32
AM/FM stereo with in-dash six CD	37
<b>Climate Controls</b>	<b>43</b>
Manual heating and air conditioning	43
Automatic temperature control	44
Rear window defroster	46
<b>Lights</b>	<b>47</b>
Headlamps	47
Turn signal control	52
Bulb replacement	53
<b>Driver Controls</b>	<b>65</b>
Windshield wiper/washer control	65
Steering wheel adjustment	66
Power windows	68
Mirrors	69
Speed control	71
<b>Locks and Security</b>	<b>74</b>
Keys	74
Locks	74
Anti-theft system	82

## Table of Contents

<b>Seating and Safety Restraints</b>	<b>89</b>
Seating	89
Safety restraints	97
Airbags	112
Child restraints	125
<b>Tires, Wheels and Loading</b>	<b>143</b>
Tire information	143
Tire inflation	145
Tire Pressure Monitoring System (TPMS)	158
Vehicle loading	163
Trailer towing	170
Recreational towing	173
<b>Driving</b>	<b>174</b>
Starting	174
Brakes	179
Traction Control™	183
Air suspension	184
Transmission operation	186
<b>Roadside Emergencies</b>	<b>190</b>
Getting roadside assistance	190
Hazard flasher control	191
Fuel pump shut-off switch	192
Fuses and relays	193
Changing tires	201
Wheel lug nut torque	207
Jump starting	208
Wrecker towing	211
<b>Customer Assistance</b>	<b>213</b>
Reporting safety defects (U.S. only)	220
Reporting safety defects (Canada only)	220
<b>Cleaning</b>	<b>221</b>

## Table of Contents

<b>Maintenance and Specifications</b>	<b>229</b>
Engine compartment	231
Engine oil	233
Battery	236
Engine coolant	238
Fuel information	244
Air filter(s)	260
Part numbers	263
Maintenance product specifications and capacities	264
Engine data	267
<b>Crown Victoria Severe Duty</b>	<b>270</b>
<b>Accessories</b>	<b>300</b>
<b>Ford Extended Service Plan</b>	<b>302</b>
<b>Scheduled Maintenance</b>	<b>306</b>
Normal scheduled maintenance and log	311
<b>Index</b>	<b>328</b>

All rights reserved. Reproduction by any means, electronic or mechanical including photocopying, recording or by any information storage and retrieval system or translation in whole or part is not permitted without written authorization from Ford Motor Company. Ford may change the contents without notice and without incurring obligation.

Copyright © 2011 Ford Motor Company

<https://www.MyCarManual.com>

3

## Introduction

### CONGRATULATIONS

Congratulations on acquiring your new Ford Motor Company product. Please take the time to get well acquainted with your vehicle by reading this handbook. The more you know and understand about your vehicle, the greater the safety and pleasure you will derive from driving it.

For more information on Ford Motor Company and its products visit the following website:

- In the United States: [www.ford.com](http://www.ford.com)
- In Canada: [www.ford.ca](http://www.ford.ca)
- In Mexico: [www.ford.com.mx](http://www.ford.com.mx)
- In Australia: [www.ford.com.au](http://www.ford.com.au)

Additional owner information is given in separate publications.

This vehicle's Owner's Guide describes every option and model variant available and therefore some of the items covered may not apply to your particular vehicle. Furthermore, due to printing cycles it may describe options before they are generally available.

Remember to pass on this vehicle's Owner's Guide when reselling the vehicle. It is an integral part of the vehicle.



**WARNING: Fuel pump shut-off switch:** In the event of an accident the safety switch will automatically cut off the fuel supply to the engine. The switch can also be activated through sudden vibration (e.g. collision when parking). To reset the switch, refer to the *Fuel pump shut-off switch* in the *Roadside Emergencies* chapter.

### SAFETY AND ENVIRONMENT PROTECTION



#### Warning symbols in this guide

How can you reduce the risk of personal injury to yourself or others? In this guide, answers to such questions are contained in comments highlighted by the warning triangle symbol. These comments should be read and observed.

## Introduction

### **Warning symbols on your vehicle**

When you see this symbol, it is imperative that you consult the relevant section of this guide before touching or attempting adjustment of any kind.



### **Protecting the environment**

We must all play our part in protecting the environment. Correct vehicle usage and the authorized disposal of waste, cleaning and lubrication materials are significant steps towards this aim. Information in this respect is highlighted in this guide with the tree symbol.



### **CALIFORNIA Proposition 65 Warning**



**WARNING:** Engine exhaust, some of its constituents, and certain vehicle components contain or emit chemicals known to the State of California to cause cancer and birth defects or other reproductive harm. In addition, certain fluids contained in vehicles and certain products of component wear contain or emit chemicals known to the State of California to cause cancer and birth defects or other reproductive harm.

### **PERCHLORATE MATERIAL**

Certain components of this vehicle such as airbag modules, seat belt pretensioners, and button cell batteries may contain Perchlorate Material – Special handling may apply for service or vehicle end of life disposal. See [www.dtsc.ca.gov/hazardouswaste/perchlorate](http://www.dtsc.ca.gov/hazardouswaste/perchlorate).

### **BREAKING-IN YOUR VEHICLE**

Your vehicle does not need an extensive break-in. Try not to drive continuously at the same speed for the first 1,000 miles (1,600 km) of new vehicle operation. Vary your speed frequently in order to give the moving parts a chance to break in.

Drive your new vehicle at least 1,000 miles (1,600 km) before towing a trailer. For more detailed information about towing a trailer, refer to *Trailer towing* in the *Tires, Wheels and Loading* chapter.

<https://www.MyCarManual.com>

## Introduction

Do not add friction modifier compounds or special break-in oils since these additives may prevent piston ring seating. See *Engine oil* in the *Maintenance and Specifications* chapter for more information on oil usage.

### SPECIAL NOTICES

#### New Vehicle Limited Warranty

For a detailed description of what is covered and what is not covered by your vehicle's New Vehicle Limited Warranty, refer to the *Warranty Guide* that is provided to you along with your Owner's Guide.

#### Special instructions

For your added safety, your vehicle is fitted with sophisticated electronic controls.



**WARNING:** Please read the section *Airbag Supplemental Restraint System (SRS)* in the *Seating and Safety Restraints* chapter. Failure to follow the specific warnings and instructions could result in personal injury.



**WARNING:** Front seat mounted rear-facing child or infant seats should **NEVER** be placed in front of an active passenger airbag.

#### Notice to owners of Severe Duty vehicles (Crown Victoria only)

Before you drive your vehicle, be sure to read the *Crown Victoria Severe Duty* chapter. This chapter contains important operation and maintenance information.

### DATA RECORDING

#### Service Data Recording

Service data recorders in your vehicle are capable of collecting and storing diagnostic information about your vehicle. This potentially includes information about the performance or status of various systems and modules in the vehicle, such as engine, throttle, steering or brake systems. In order to properly diagnose and service your vehicle, Ford Motor Company, Ford of Canada, and service and repair facilities may access or share among them vehicle diagnostic information received through a direct connection to your vehicle when diagnosing or servicing

## Introduction

your vehicle. For U.S. only (if equipped), if you choose to use the SYNC® Vehicle Health Report, you consent that certain diagnostic information may also be accessed electronically by Ford Motor Company and Ford authorized service facilities, and that the diagnostic information may be used for any purpose. See your SYNC® supplement for more information.

### Event Data Recording

**This vehicle is equipped with an event data recorder (EDR). The main purpose of an EDR is to record, in certain crash or near crash-like situations, such as an airbag deployment or hitting a road obstacle; this data will assist in understanding how a vehicle's systems performed. The EDR is designed to record data related to vehicle dynamics and safety systems for a short period of time, typically 30 seconds or less. The EDR in this vehicle is designed to record such data as:**

- **How various systems in your vehicle were operating;**
- **Whether or not the driver and passenger seatbelts were buckled/fastened;**
- **How far (if at all) the driver was depressing the accelerator and/or the brake pedal; and**
- **How fast the vehicle was travelling; and**
- **Where the driver was positioning the steering wheel.**

**This data can help provide a better understanding of the circumstances in which crashes and injuries occur.**

**Note: EDR data is recorded by your vehicle only if a non-trivial crash situation occurs; no data is recorded by the EDR under normal driving conditions and no personal data or information (e.g., name, gender, age, and crash location) is recorded (see limitations regarding 911 Assist and Traffic, directions and Information privacy below). However, parties, such as law enforcement, could combine the EDR data with the type of personally identifying data routinely acquired during a crash investigation.**

## Introduction

To read data recorded by an EDR, special equipment is required, and access to the vehicle or the EDR is needed. In addition to the vehicle manufacturer, other parties, such as law enforcement, that have such special equipment, can read the information if they have access to the vehicle or the EDR. Ford Motor Company and Ford of Canada do not access event data recorder information without obtaining consent, unless pursuant to court order or where required by law enforcement, other government authorities or other third parties acting with lawful authority. Other parties may seek to access the information independently of Ford Motor Company and Ford of Canada.

**Note:** Including to the extent that any law pertaining to Event Data Recorders applies to SYNC® or its features, please note the following: Once 911 Assist (if equipped) is enabled (set ON), 911 Assist may, through any paired and connected cell phone, disclose to emergency services that the vehicle has been in a crash involving the deployment of an airbag or, in certain vehicles, the activation of the fuel pump shut-off. Certain versions or updates to 911 Assist may also be capable of being used to electronically or verbally provide to 911 operators the vehicle location (such as latitude and longitude), and/or other details about the vehicle or crash or personal information about the occupants to assist 911 operators to provide the most appropriate emergency services. If you do not want to disclose this information, do not activate the 911 Assist feature. See your SYNC® supplement for more information.

Additionally, when you connect to Traffic, Directions and Information (if equipped, U.S. only) the service uses GPS technology and advanced vehicle sensors to collect the vehicle's current location, travel direction, and speed ("vehicle travel information") only to help provide you with the directions, traffic reports, or business searches your request. If you do not want Ford or its vendors to receive this information, do not activate the service. Ford Motor Company and the vendors it uses to provide you with this information do not store your vehicle travel information. For more information, see Traffic, Directions and Information, Terms and Conditions. See your SYNC® supplement for more information.



## Introduction

### CELL PHONE USE

The use of Mobile Communications Equipment has become increasingly important in the conduct of business and personal affairs. However, drivers must not compromise their own or others' safety when using such equipment. Mobile Communications can enhance personal safety and security when appropriately used, particularly in emergency situations. Safety must be paramount when using mobile communications equipment to avoid negating these benefits.

Mobile Communication Equipment includes, but is not limited to, cellular phones, pagers, portable email devices, text messaging devices and portable two-way radios.



**WARNING:** Driving while distracted can result in loss of vehicle control, accident and injury. Ford strongly recommends that you use extreme caution when using any device or feature that may take your focus off the road. Your primary responsibility is the safe operation of your vehicle.

We recommend against the use of any handheld device while driving and that you comply with all applicable laws.









### EXPORT UNIQUE (NON-UNITED STATES/CANADA) VEHICLE SPECIFIC INFORMATION

For your particular global region, your vehicle may be equipped with features and options that are different from the features and options that are described in this Owner's Guide. A market unique supplement may be supplied that complements this book. By referring to the market unique supplement, if provided, you can properly identify those features, recommendations and specifications that are unique to your vehicle. This Owner's Guide is written primarily for the U.S. and Canadian Markets. Features or equipment listed as standard may be different on units built for Export. **Refer to this Owner's Guide for all other required information and warnings.**





















## Introduction

These are some of the symbols you may see on your vehicle.

### Vehicle Symbol Glossary

Safety Alert		See Owner's Guide	
Fasten Safety Belt		Airbag - Front	
Airbag - Side		Child Seat Lower Anchor	
Child Seat Tether Anchor		Brake System	
Anti-Lock Brake System		Parking Brake System	
Brake Fluid - Non-Petroleum Based		Parking Aid System	
Stability Control System		Speed Control	
Master Lighting Switch		Hazard Warning Flasher	
Fog Lamps-Front		Fuse Compartment	
Fuel Pump Reset		Windshield Wash/Wipe	
Windshield Defrost/Demist		Rear Window Defrost/Demist	

Vehicle Symbol Glossary

Power Windows Front/Rear		Power Window Lockout	
Child Safety Door Lock/Unlock		Interior Luggage Compartment Release	
Panic Alarm		Engine Oil	
Engine Coolant		Engine Coolant Temperature	
Do Not Open When Hot		Battery	
Avoid Smoking, Flames, or Sparks		Battery Acid	
Explosive Gas		Fan Warning	
Power Steering Fluid		Maintain Correct Fluid Level	
Service Engine Soon		Engine Air Filter	
Passenger Compartment Air Filter		Jack	
Check Fuel Cap		Low Tire Pressure Warning	

## Instrument Cluster

### WARNING LIGHTS AND CHIMES

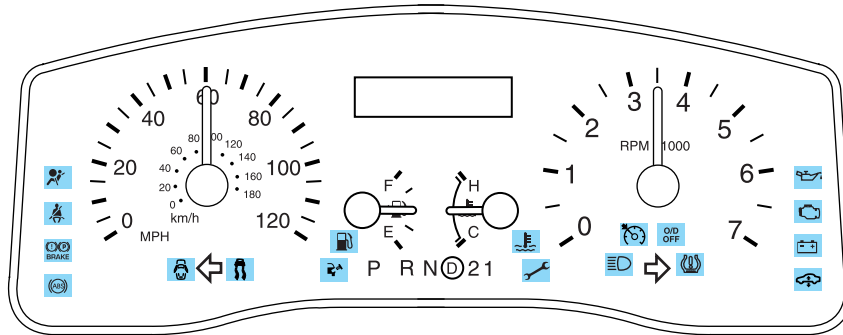

### Standard instrument cluster

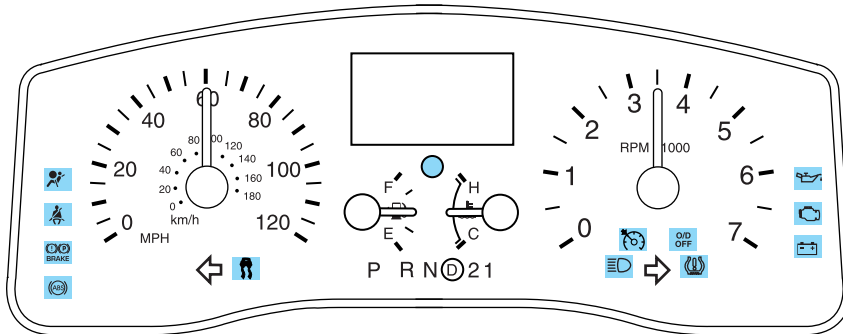

### Optional instrument cluster

Warning lights and gauges can alert you to a vehicle condition that may become serious enough to cause expensive repairs. A warning light may illuminate when a problem exists with one of your vehicle's functions. Many lights will illuminate when you start your vehicle to make sure the bulb works. If any light remains on after starting the vehicle, refer to the respective system warning light for additional information.

## Instrument Cluster

**Service engine soon:** The service engine soon indicator light illuminates when the ignition is first turned on to check the bulb and to indicate whether the vehicle is ready for Inspection/Maintenance (I/M) testing. Normally, the service engine soon light will stay on until the engine is cranked, then turn itself off if no malfunctions are present. However, if after 15 seconds the service engine soon light blinks eight times, it means that the vehicle is not ready for I/M testing. See the *Readiness for Inspection/Maintenance (I/M) testing* in the *Maintenance and Specifications* chapter.

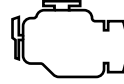

Solid illumination after the engine is started indicates the on-board diagnostics system (OBD-II) has detected a malfunction. Refer to *On-board diagnostics (OBD-II)* in the *Maintenance and Specifications* chapter. If the light is blinking, engine misfire is occurring which could damage your catalytic converter. Drive in a moderate fashion (avoid heavy acceleration and deceleration) and contact your authorized dealer as soon as possible.



**WARNING:** Under engine misfire conditions, excessive exhaust temperatures could damage the catalytic converter, the fuel system, interior floor coverings or other vehicle components, possibly causing a fire.

**Powertrain malfunction indicator (if equipped):** Illuminates when a powertrain fault has been detected. Contact your authorized dealer as soon as possible.



**Check fuel cap (if equipped):** Illuminates when the fuel cap may not be properly installed. Continued driving with this light on may cause the Service engine soon warning light to come on. Refer to *Fuel filler cap* in the *Maintenance and Specifications* chapter.



## Instrument Cluster

**Brake system warning light:** To confirm the brake system warning light is functional, it will momentarily illuminate when the ignition is turned to the on position when the engine is not running, or in a position between on and start, or by applying the parking brake when the ignition is turned to the on position. If the brake system warning light does not illuminate at this time, seek service immediately from your authorized dealer. Illumination after releasing the parking brake indicates low brake fluid level and the brake system should be inspected immediately by your authorized dealer.



 **WARNING:** Driving a vehicle with the brake system warning light on is dangerous. A significant decrease in braking performance may occur. It will take you longer to stop the vehicle. Have the vehicle checked by your authorized dealer. Driving extended distances with the parking brake engaged can cause brake failure and the risk of personal injury.

**Anti-lock brake system:** If the ABS light stays illuminated or continues to flash, a malfunction has been detected, have the system serviced immediately by your authorized dealer. Normal braking is still functional unless the brake warning light also is illuminated.

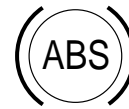

**Airbag readiness:** If this light fails to illuminate when the ignition is turned to on, continues to flash or remains on, have the system serviced immediately by your authorized dealer. A chime will sound when there is a malfunction in the indicator light.



**Safety belt:** Reminds you to fasten your safety belt. A Belt-Minder® chime will also sound to remind you to fasten your safety belt. Refer to the *Seating and Safety Restraints* chapter to activate/deactivate the Belt-Minder® chime feature.



## Instrument Cluster

**Charging system:** Illuminates when the battery is not charging properly. If it stays on while the engine is running, there may be a malfunction with the charging system. Contact your authorized dealer as soon as possible. This indicates a problem with the electrical system or a related component.



**Engine oil pressure:** Illuminates when the oil pressure falls below the normal range. Check the oil level and add oil if needed. Refer to *Engine oil* in the *Maintenance and Specifications* chapter.

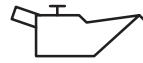

**Engine coolant temperature:** Illuminates when the engine coolant temperature is high. Stop the vehicle as soon as possible, switch off the engine and let cool. Refer to *Engine coolant* in the *Maintenance and Specifications* chapter.



**WARNING:** Never remove the coolant reservoir cap while the engine is running or hot.

**Traction Control™ :** Flashes when the Traction Control™ system is active. It will be illuminated solidly if there is a fault with the system; traction control will be disabled. Have the system serviced immediately. Refer to the *Driving* chapter for more information.



**Severity indicator (if equipped):** Displays the indicated severity color when any of the following warning conditions has occurred:

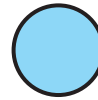

- Red: Low Oil Pressure, Charge System, Engine Coolant Over Temperature, Door Ajar
- Amber: Low Fuel

Refer to *Message center* in this chapter.

## Instrument Cluster

### **Low tire pressure warning:**

Illuminates when your tire pressure is low. If the light remains on at start up or while driving, the tire pressure should be checked. Refer to *Inflating your tires* in the *Tires, Wheels and Loading* chapter. When the ignition is first turned to on, the light will illuminate for three seconds to ensure the bulb is working. If the light does not turn on, have the system inspected by your authorized dealer. For more information on this system, refer to *Tire pressure monitoring system (TPMS)* in the *Tires, Wheels and Loading* chapter.

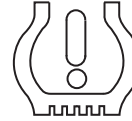

### **Air suspension (if equipped):**

Illuminates when the air suspension is turned off, the load limit is exceeded or the air suspension system requires servicing.

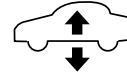

### **Low fuel (if equipped):**

Illuminates when the fuel level in the fuel tank is at or near empty (refer to *Fuel gauge* in this chapter for more information).



**O/D off:** Illuminates when the overdrive function of the transmission has been turned off; refer to the *Driving* chapter. If the light does not illuminate, have the transmission serviced soon, or damage may occur.



### **Speed control (if equipped):**

Illuminates when the speed control is activated. Turns off when the speed control system is deactivated.



### **Door ajar (if equipped):**

Illuminates when one of the doors is not completely shut and the ignition is turned to on. With the ignition in on position, a tone will sound for one second (if a door is open).





## Instrument Cluster

**Turn signal:** Illuminates when the left or right turn signal or the hazard lights are turned on. If the indicators stay on or flash faster, check for a burned out bulb.



**High beams:** Illuminates when the high beam headlamps are turned on.



**Headlamps on warning chime:** Sounds when the headlamps or parking lamps are on, the ignition is off (the key is not in the ignition) and the driver's door is opened.

**Key-in-ignition warning chime:** Sounds when the key is left in the ignition in the off or accessory position and the driver's door is opened.

### GAUGES

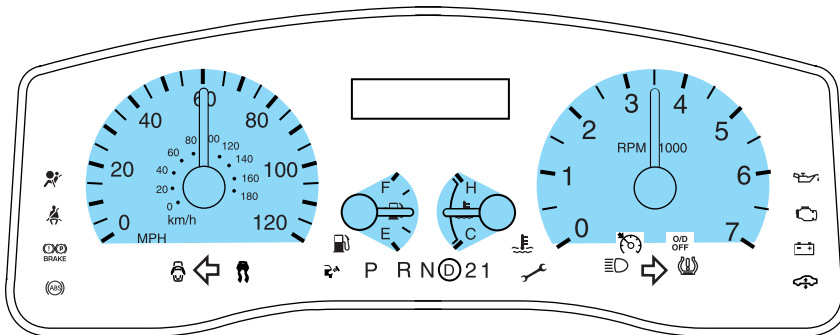

**Speedometer:** Indicates the current vehicle speed. Refer to the *Message center* in this chapter to change your display to a digital speedometer. The digital display is more accurate than the analog gauge and may not match.

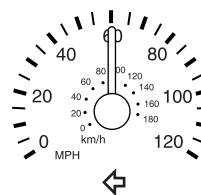

## Instrument Cluster

**Engine coolant temperature gauge:** Indicates engine coolant temperature. At normal operating temperature, the needle will be in the normal range (between “H” and “C”). **If it enters the red section, the engine is overheating. Stop the vehicle as soon as safely possible, switch off the engine and let the engine cool.**

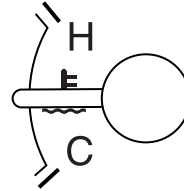

**WARNING:** Never remove the coolant reservoir cap while the engine is running or hot.

**Odometer:** Registers the total miles (kilometers) of the vehicle.

- Without Message center

To switch the display from Metric to English, press and hold the button on the cluster for three seconds.



- With Message center

Refer to *Message center* in this chapter on how to switch the display from Metric to English and the odometer to the speedometer.

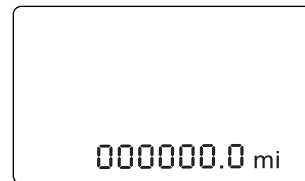

**Trip odometer:** Registers the miles (kilometers) of individual journeys.

- Without message center

Press and release the button on the cluster to switch between odometer and trip odometer display. To reset, press the button again until the trip reading resets.



## Instrument Cluster

- With message center

See *TRIP A/B* under *Message center* in this chapter.

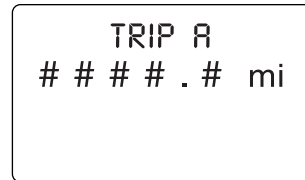

**Tachometer:** Indicates the engine speed in revolutions per minute. Driving with your tachometer pointer continuously at the top of the scale may damage the engine.

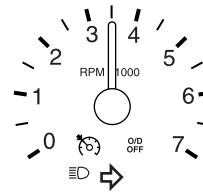

**Fuel gauge:** Indicates approximately how much fuel is left in the fuel tank (when the ignition is in the on position). The fuel gauge may vary slightly when the vehicle is in motion or on a grade.

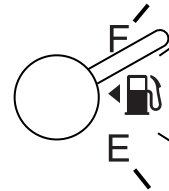

The arrow near the fuel pump icon indicates which side of the vehicle the fuel filler door is located.

Refer to *Filling the tank* in the *Maintenance and Specifications* chapter for more information.

### MESSAGE CENTER (IF EQUIPPED)

With the ignition in the on position, the message center, located on your instrument cluster, displays important vehicle information

**through a constant monitor of vehicle systems.** You may select display features on the message center for a display of status. The

system will also notify you of potential vehicle problems with a display of system warnings followed by a long indicator chime.

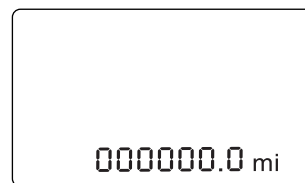

## Instrument Cluster

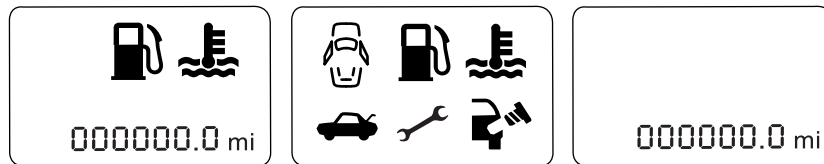

Your display can show up to three reconfigurable telltales at one time. What ever is displayed in the top left corner has the highest priority. Premium Display Severity Indicator (located under the message center): Indicates severity of the information being displayed on the premium display. Red for high severity, amber for medium severity, and non-lit for information only. For example, a door ajar warning would be accompanied by a red indicator, low fuel by an amber indicator, and fuel economy by an absence of the indicator. The indicator always illuminates with the highest severity rating of the warnings displayed.

### Info (Information menu)

Press the INFO button repeatedly to cycle through the following features listed:



Press the RESET button reset functions in the information menu.

### TRIP A/B

Registers the distance of individual journeys. Press and release INFO button until the A or B trip appears in the display (this represents the trip mode). Press and hold the RESET button for two seconds to reset.

Refer to *UNITS* later in this section to switch the display from Metric to English.

### MILES (km) TO EMPTY

This displays an estimate of approximately how far you can drive with the fuel remaining in your tank under normal driving conditions. Remember to turn the ignition off when refueling to allow this feature to correctly detect the added fuel.

## Instrument Cluster

The DTE function will display FUEL LEVEL LOW and sound a tone for one second when you have approximately 50 miles (80 km) to empty. If you RESET this warning message, this display and tone will return within 10 minutes or 10 miles (16 km).

DTE is calculated using a running average fuel economy, which is based on your recent driving history of 500 miles (800 km). This value is not the same as the average fuel economy display. The running average fuel economy is reinitialized to a factory default value if the battery is disconnected.

### **AVERAGE FUEL XX.X MPG (L/100km)**

Average fuel economy displays your average fuel economy in miles/gallon or liters/100 km.

If you calculate your average fuel economy by dividing gallons of fuel used by 100 miles traveled (kilometers traveled by liters used), your figure may be different than displayed for the following reasons:

- Your vehicle was not perfectly level during fill-up
- Differences in the automatic shut-off points on the fuel pumps at service stations
- Variations in top-off procedure from one fill-up to another
- Rounding of the displayed values to the nearest 0.1 gallon (liter)

1. Drive the vehicle at least 5 miles (8 km) with the speed control system engaged to display a stabilized average.

2. Record the highway fuel economy for future reference.

It is important to press the RESET control (press and hold RESET for two seconds in order to reset the function) after setting the speed control to get accurate highway fuel economy readings.

### **FUEL ECONOMY MPG (L/km) ↑ ↓**

This displays instantaneous fuel economy as a bar graph ranging from ↓ poor economy to ↑ excellent economy.

Your vehicle must be moving to calculate instantaneous fuel economy. When your vehicle is not moving, this function shows ↓, one or no bars illuminated. Instantaneous fuel economy cannot be reset.

### **TIMER**

Timer displays the trip elapsed drive time.

To operate, do the following:

1. Press and release RESET in order to start the timer.

## Instrument Cluster

2. Press and release RESET to pause the timer.
3. Press and hold RESET until the timer resets.

### System Check and Vehicle Feature Customization

Press the SETUP button repeatedly to cycle the message center through the following features listed:



Press SELECT to select functions in the setup menu:

### PRESS SELECT TO BEGIN SYSTEM CHECK

When this message appears, press SELECT and the message center will begin to cycle through the following systems and provide a status of the item if needed.

**Note:** Some systems show a message only if a condition is present.

1. OIL LIFE  
— HOLD RESET IF NEW OIL
2. WASHER FLUID
3. AIR SUSPENSION (if equipped)
4. RECONFIGURABLE TELLTALES  
— OK  
— FAILED RED  
— FAILED AMBER

### SCREEN FORM

Press SELECT to change the display:

- ODOMETER
- SPEEDO

### TEXT SIZE

Press SELECT to change the display text size:

- NORMAL
- LARGE

## Instrument Cluster

### **UNITS**

Displays the current units English or Metric.

Press SELECT to change the display units.

- ENGLISH
- METRIC

### **LANGUAGE**

Displays the current language selected.

Press SELECT to change the display language.

- ENGLISH
- ESPANOL
- FRANCAIS

### **OIL LIFE START VALUE PRESS SELECT TO CHANGE**

Press SELECT to change the oil life start value. OIL LIFE START VALUE SET TO XXX% will be displayed.

To reset the oil monitoring system to 100% after each oil change, perform the following:

1. Press and hold the RESET control for two seconds and release. Oil life is set to 100% and “OIL LIFE XXX% HOLD RESET IF NEW OIL” is displayed.
2. Press and hold the RESET control for three seconds and release. Oil life is set to 100% and “OIL LIFE START VALUE SET TO XXX%” is displayed.

### **System warnings**

System warnings alert you to possible problems or malfunctions in your vehicle's operating systems.

In the event of a multiple warning situation, the message center will cycle the display to show all warnings by displaying each one for four seconds.

The message center will display the last selected feature if there are no more warning messages. This allows you to use the full functionality of the message center after you acknowledge the warning by pressing the RESET control and clearing the warning message.

## Instrument Cluster

Warning messages that have been reset are divided into three categories:

- They cannot be reset until the condition is corrected.
- They will reappear on the display 10 minutes from the reset.
- They will not reappear until an ignition off-on cycle has been completed.

This acts as a reminder that these warning conditions still exist within the vehicle.

**DOOR AJAR** — Displayed when a door is not completely closed.

**POWERTRAIN MALFUNCTION** — Displayed when the powertrain is not operating properly. If the warning stays on or continues to come on, contact your authorized dealer as soon as possible.

**COOLANT OVER TEMPERATURE** — Displayed when the engine coolant is overheating. Stop the vehicle as soon as safely possible, turn off the engine and let it cool. Check the coolant and coolant level. Refer to *Engine coolant* in the *Maintenance and Specifications* chapter. If the warning stays on or continues to come on, contact your authorized dealer as soon as possible.



**WARNING:** Never remove the coolant reservoir cap while the engine is running or hot.

**CHECK FUEL CAP** — Displayed when the fuel filler cap is not properly installed. Check the fuel filler cap for proper installation. Refer to *Fuel filler cap* in the *Maintenance and Specifications* chapter.

**CHECK AIR SUSPENSION** — Displayed when the air suspension system is not operating properly. If this message is displayed while driving, pull off the road as soon as safely possible. For more information, refer to *Air suspension system* in the *Driving* chapter.

**AIR SUSP OFF** — Displayed when the air suspension system is turned off. For more information, refer to *Air suspension system* in the *Driving* chapter.

**FUEL LEVEL LOW** — Displayed as an early reminder of a low fuel condition. Warning message can be reset by pressing the RESET button, but will return after 10 minutes. If any other button is pressed besides RESET, the message "PRESS RESET TO CLEAR" will appear in the message center. Once this message disappears (after approximately two seconds), press RESET to clear the warning.



## Instrument Cluster

**TRUNK AJAR** — Displayed when the trunk is not completely closed.

**OVERDRIVE OFF** — Displayed when the overdrive is enabled or disabled.

**LOW TIRE PRESSURE** — Displayed when one or more tires on your vehicle have low tire pressure. Refer to *Inflating your tires* in the *Tires, Wheels and Loading* chapter.

**TIRE PRESSURE MONITOR FAULT** — Displayed when the Tire Pressure Monitoring System is malfunctioning. If the warning stays on or continues to come on, contact your authorized dealer as soon as possible.

**TIRE PRESSURE SENSOR FAULT** — Displayed when a tire pressure sensor is malfunctioning, or your spare tire is in use (Note: this includes the use of the optional full-sized matching spare tire and wheel). For more information on how the system operates under these conditions, refer to *Tire Pressure Monitoring System (TPMS)* in the *Tires, Wheels and Loading* chapter. If the warning stays on or continues to come on, contact your authorized dealer as soon as possible.

**WASHER FLUID LEVEL LOW** — Indicates the washer fluid reservoir is less than one quarter full. Check the washer fluid level. Refer to *Windshield washer fluid* in the *Maintenance and Specifications* chapter.

**ENGINE OIL CHANGE SOON** — Displayed when the engine oil life remaining is 10% or less.

**OIL CHANGE REQUIRED** — Displayed when the oil life left reaches 0%.

An oil change is required whenever indicated by the message center and according to the recommended maintenance schedule. Use only recommended engine oils.

## Entertainment Systems

### AUDIO SYSTEMS

#### AM/FM stereo (if equipped)

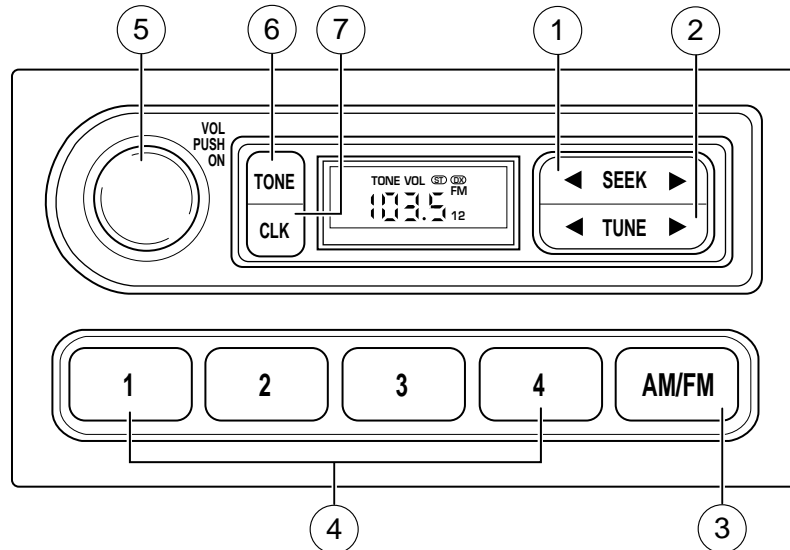

**!** **WARNING:** Driving while distracted can result in loss of vehicle control, accident and injury. Ford strongly recommends that drivers use extreme caution when using any device or feature that may take their focus off the road. Your primary responsibility is the safe operation of the vehicle. We recommend against the use of any handheld device while driving, encourage the use of voice-operated systems when possible and that you become aware of applicable state and local laws that may affect use of electronic devices while driving.

1. **Seek:** Press ◀ / ▶ to find the next strong station down/up the frequency band.



2. **Tune:** Press ◀ / ▶ to manually change radio frequency down/up.



## Entertainment Systems

3. **AM/FM:** Press to choose a frequency band in radio mode.



4. **Memory preset buttons:** To set a station: Select frequency band AM/FM; tune to a station, press and hold a preset button until sound returns.



5. **Power/volume:** Press to turn ON/OFF; turn to increase or decrease volume levels.

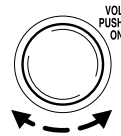

6. **Tone:** Press TONE until the desired level — Bass, Treble, Fade appears on the display. Turn the volume control to raise/lower the levels, or to move the audio sound from the right to left or the front to back (if equipped).

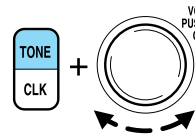

7. **CLK (Clock):** To set the hour, press and hold CLK until CLOCK SET appears in the display. Continue to hold CLK as you press SEEK to decrease ◀ or increase ▶ the hours.



To set the minute, press and hold CLK until CLOCK set appears in the display. Continue to hold CLK as you press TUNE to decrease ◀ or increase ▶ the minutes.

## Entertainment Systems

### AM/FM Stereo Single CD Premium audio system (if equipped)

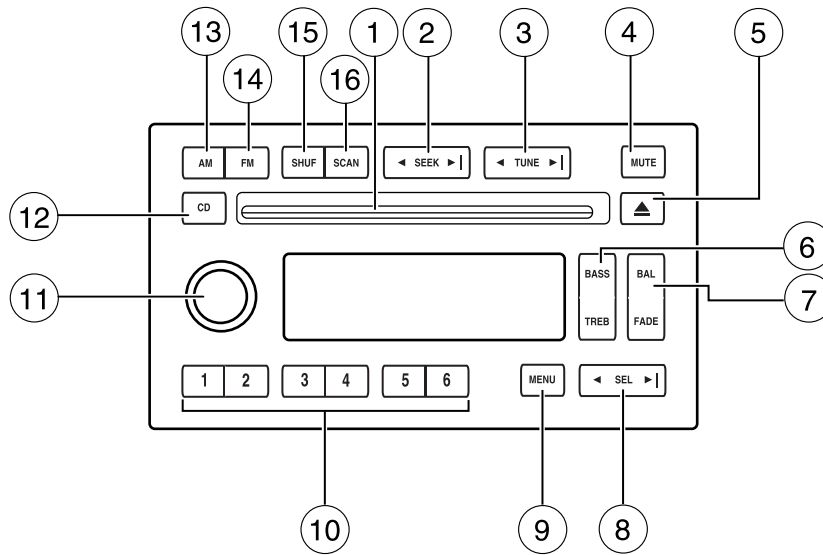

**WARNING:** Driving while distracted can result in loss of vehicle control, accident and injury. Ford strongly recommends that drivers use extreme caution when using any device or feature that may take their focus off the road. Your primary responsibility is the safe operation of the vehicle. We recommend against the use of any handheld device while driving, encourage the use of voice-operated systems when possible and that you become aware of applicable state and local laws that may affect use of electronic devices while driving.

1. **CD slot:** Insert a CD, label side up. With the ignition on, the radio will begin play when a CD is inserted. If the ignition is off, press CD prior to inserting a disc. Do not force a disc into the system as damage could result.



2. **SEEK:** Press to access the next (▶) or previous (◀) radio station or CD track. Press and hold to advance/reverse in the current CD track.



## Entertainment Systems

3. **TUNE:** Press to manually go up (▶) or down (◀) the radio frequency.



4. **MUTE:** Press to mute the playing media. Press again to return to the playing media or turn the volume control to adjust the volume.



5. **Eject:** Press to eject the CD. If the disc is not removed within the allotted time, the system will



automatically reload the CD and begin play. **Note:** The eject function will work when the ignition is turned off.

6. **BASS:** Press BASS; then press ◀ SEL ▶ to decrease/increase the level of bass output.



**TREB (Treble):** Press TREB; then press ◀ SEL ▶ to decrease/increase the level of treble output.

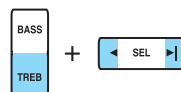

7. **BAL (Balance):** Press BAL; then press ◀ SEL ▶ to shift sound to the left/right speakers.



**FADE:** Press FADE; then press ◀ SEL ▶ to shift sound to the rear/front speakers.

8. **SEL:** Use with Bass, Treble, Balance, Fade and other menu functions.



## Entertainment Systems

9. **MENU:** Press MENU to access the following functions:



**Autoset:** Allows you to set the strongest local radio stations without losing your original manually set preset stations for AM/FM1/FM2. Press MENU until AUTOSET appears in the display. Press ◀ SEL ▶ to turn ON or OFF. When the six strongest stations are filled, the station stored in preset 1 will begin playing. If there are less than six strong stations, the system will store the last one in the remaining presets. When activated, AUTOSET will momentarily appear in the display when any of the preset controls are pressed.

**Compression:** Brings soft and loud CD passages together for a more consistent listening level when in CD mode. Press MENU until compression status is displayed. Press ◀ SEL ▶ to enable the compression feature when COMPRESS OFF is displayed. Press SEL again to disable the feature when COMPRESS ON is displayed. When activated, the compression icon will appear in the display.

**Speed sensitive volume:** Radio volume changes automatically and slightly with vehicle speed to compensate for road and wind noise. Recommended level is 1–3. Level 0 turns the feature off and level 7 is the maximum setting.

Press MENU to access and use ◀ SEL ▶ to adjust the volume setting. The level will appear in the display.

**Setting the clock:** Press MENU until SET HOURS or SET MINUTES is displayed. Press ◀ SEL ▶ to manually decrease/increase the hours/minutes. Press MENU again to disengage clock mode.

**Note:** The menu selections will remain in the display for approximately 10 seconds, at which time the display will return to the previous mode. You may also exit the menu options by pressing any other audio control.

10. **Memory presets:** To set a station: Select frequency band, tune to a station, press and hold a preset button until sound returns.

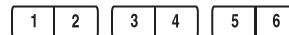

## Entertainment Systems

11. **On/Off/Volume:** Press to turn on/off; turn to adjust the volume levels.

**Note:** With the ignition turned off, you may press the volume control to momentarily view the clock.

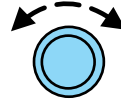

12. **CD:** Press to enter CD mode if a CD is already present in the system. In radio mode, the CD icon will appear in the display if a CD is loaded into the system.

13. **AM:** Press to select the AM frequency.



14. **FM:** Press to select the FM frequency. Press repeatedly to switch between FM1 and FM2.



15. **SHUF (Shuffle):** Press to play all tracks on the current CD in random order. Press again to stop.



16. **SCAN:** Press SCAN to hear a brief sampling of radio stations or CD tracks. Press again to stop.



## Entertainment Systems

### Premium/Premium sound satellite compatible AM/FM stereo Single CD/Cassette system (if equipped)

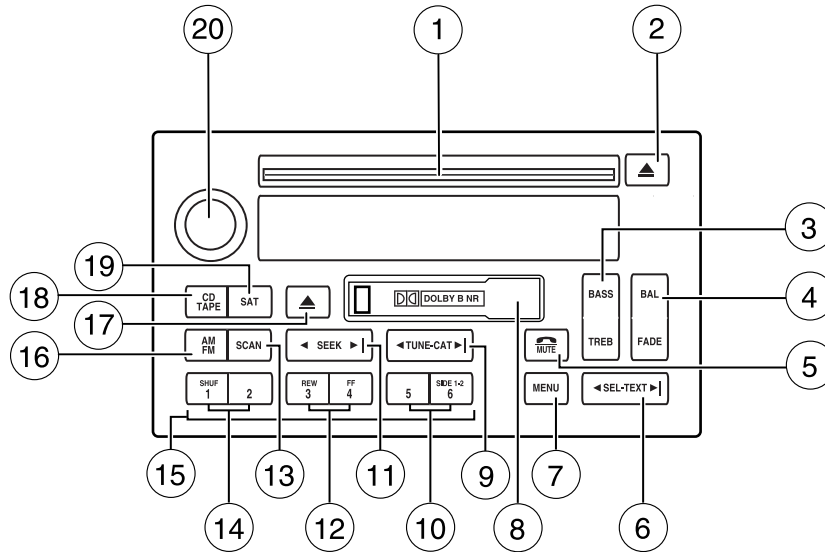

**WARNING:** Driving while distracted can result in loss of vehicle control, accident and injury. Ford strongly recommends that drivers use extreme caution when using any device or feature that may take their focus off the road. Your primary responsibility is the safe operation of the vehicle. We recommend against the use of any handheld device while driving, encourage the use of voice-operated systems when possible and that you become aware of applicable state and local laws that may affect use of electronic devices while driving.

**1. CD slot:** Insert a CD, label side up. With the ignition on, the radio will begin to play a CD once inserted. With the ignition off, the CD control must be pressed before inserting the disc. Failure may result in damage to the CD and/or audio system.





## Entertainment Systems

2. **CD eject:** Press to eject a CD. If the disc is not removed within the allotted time, the system will automatically reload the CD and begin play. **Note:** The eject function will work when the ignition is turned off.



3. **BASS:** Press BASS; then press ◀ SEL-TEXT ▶ to decrease/increase the level of bass output.

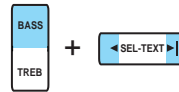

**TREB (Treble):** Press TREB; then press ◀ SEL-TEXT ▶ to decrease/increase the level of treble output.

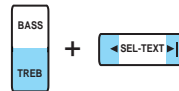

4. **BAL (Balance):** Press BAL; then press ◀ SEL-TEXT ▶ to shift sound to the left/right speakers.

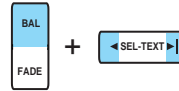

**FADE:** Press FADE; then press ◀ SEL-TEXT ▶ to shift sound to the rear/front speakers.



5. **Phone/mute:** Press to mute the playing media. Press again to return to the playing media or turn the volume control to adjust the volume.



6. **SEL/TEXT:** Use with Bass, Treble, Balance, Fade and other menu functions.



**TEXT:** TEXT is only available when equipped with Satellite radio. Your radio may be equipped with Satellite ready capability. The kit to enable Satellite reception is available through your dealer. Detailed Satellite instructions are included with the dealer installed kit. *Check with your authorized dealer for availability.*

## Entertainment Systems

7. **MENU:** Press MENU repeatedly to access RDS ON/OFF. Press



◀ SEL-TEXT ▶ to switch RDS

ON or OFF. Press MENU again to access Program type mode or Show Type/Name mode. (MENU must be pressed within 10 seconds to proceed to the next RDS mode.)

The Federal Communications Commission (FCC) and the Canadian Radio and Telecommunications Commission (CRTC) recommend that FM radio broadcasters use RDS technology to transmit information. FM radio stations are independently operated and individually elect to use RDS technology to transmit station ID and program type as desired.

**FIND Program type:** Allows you to search RDS-equipped stations for a certain category of music format: Classic, Country, Info, Jazz, Oldies, R&B, Religious, Rock, Soft, Top 40.

With RDS ON, press MENU until the program type menu is displayed.

One of the various program types will appear. Press ◀ SEL-TEXT ▶

to scroll through music types. Press SEEK or SCAN to search for a station playing the requested music category.

**Show TYPE:** Selects between displaying the station's call letters or music format when RDS is enabled. Press and hold MENU until SHOW XX appears in the display. Press ◀ SEL-TEXT ▶ to select NAME or TYPE.

**Compression:** Brings soft and loud CD passages together for a more consistent listening level when in CD mode. Press MENU repeatedly until compression status is displayed. Press ◀ SEL-TEXT ▶ control to enable the compression feature when COMPRESS OFF is displayed. Press ◀ SEL-TEXT ▶ control again to disable the feature when COMPRESS ON is displayed. When activated, the compression icon will appear in the display.

**Occupancy mode** (Available only on Premium sound audios): Press MENU repeatedly until occupancy mode appears in the display.

Press ◀ SEL-TEXT ▶ to select ALL SEATS, DRIVERS SEATS or REAR SEATS occupancy mode.

**Autoset:** Allows you to set the strongest local radio stations without losing your original manually set preset stations for AM/FM1/FM2. Press MENU repeatedly until AUTOSSET appears in the display. Press

◀ SEL-TEXT ▶ to switch ON or OFF. When the six strongest stations are filled, the station stored in preset 1 will begin playing. If there are less

## Entertainment Systems

than six strong stations, the system will store the last one in the remaining presets. When activated, AUTOSET will momentarily appear in the display when any of the preset controls are pressed.

**Speed sensitive volume:** Radio volume changes automatically and slightly with vehicle speed to compensate for road and wind noise. Recommended level is 1–3. Level 0 turns the feature off and level 7 is the maximum setting.

Press MENU repeatedly to access and use ◀ SEL/TEXT ▶ to adjust the volume setting. The level will appear in the display.

**Dolby:** Works in tape mode to reduce tape noise and hiss. Press MENU until DOLBY XX appears in the display. Press ◀ SEL-TEXT ▶ to switch ON or OFF.

The Dolby® noise reduction system is manufactured under license from Dolby Laboratories Licensing Corporation. Dolby® and the double-D symbol are registered trademarks of Dolby Laboratories Licensing Corporation.

**Setting the clock:** Press MENU repeatedly until SET HOURS or SET MINUTES is displayed. Press ◀ SEL-TEXT ▶ to manually decrease/increase the hours/minutes. Press MENU again to disengage clock mode.

**Note:** The menu selections will remain in the display for approximately 10 seconds, at which time the display will return to the previous mode. You may also exit the menu options by pressing any other audio control.

8. **Cassette:** Insert a cassette facing to the right.

9. **TUNE:** Press to manually go up or down the radio frequency.



**CAT:** CAT is only available when equipped with Satellite Radio. Your system may be equipped with Satellite ready capability. The kit to enable Satellite reception is available through your dealer. Detailed Satellite instructions are included with the dealer installed kit. *Check with your authorized dealer for availability.*

10. **Side 1–2:** Press to access the next side of the cassette tape. The display will indicate whether TAPE 1 or TAPE 2 is playing.



## Entertainment Systems

11. **SEEK:** Press to access the next/previous radio station, tape selection or CD track.



12. **REW (Rewind):** Press to rewind in tape or CD mode.



**FF (Fast forward):** Press to fast forward in tape or CD mode.



13. **SCAN:** Press SCAN to hear a brief sampling of radio stations, selections or CD tracks. Press again to stop.



14. **SHUF (Shuffle):** Press to play the tracks on the current CD in random order. Press again to stop.



15. **Memory presets:** To set a station: Select frequency band, tune to a station, press and hold a preset button until sound returns.

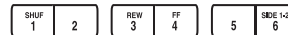

16. **AM/FM:** Press to switch between AM/FM1/FM2 modes.



17. **Tape eject:** Press to eject the tape.



18. **CD/TAPE:** Press to switch between CD and TAPE mode. In radio and tape mode, the CD icon will appear in the display if a CD is loaded into the system.



19. **SAT:** Your system may be equipped with Satellite Ready capability. The kit to enable the Satellite reception is available through your dealer. Detailed satellite instructions are included with the dealer installed kit. *Check with your authorized dealer for availability.*



## Entertainment Systems

20. **On/Off/Volume:** Press to turn on/off; turn to adjust the volume levels. **Note:** With the ignition turned off, you may press the volume control to momentarily view the clock.

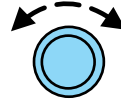

**AM/FM Premium sound satellite compatible Stereo In-dash Six CD sound system (if equipped)**

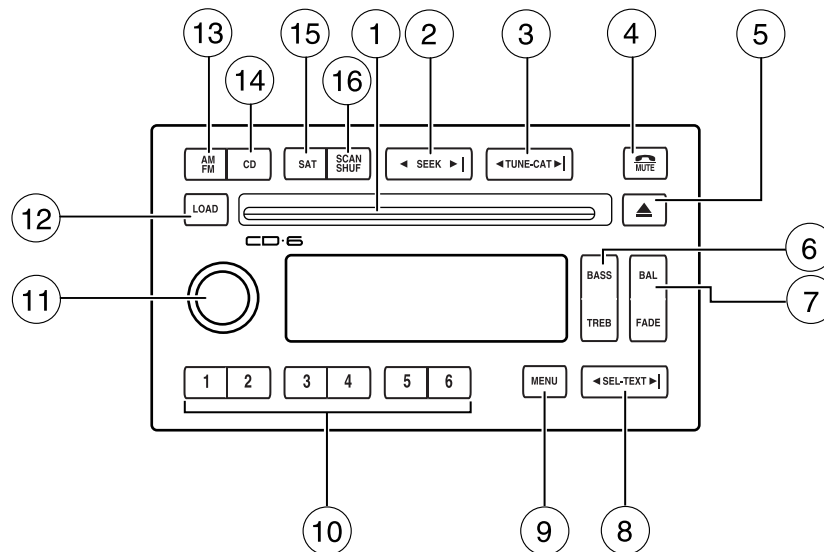

**⚠ WARNING:** Driving while distracted can result in loss of vehicle control, accident and injury. Ford strongly recommends that drivers use extreme caution when using any device or feature that may take their focus off the road. Your primary responsibility is the safe operation of the vehicle. We recommend against the use of any handheld device while driving, encourage the use of voice-operated systems when possible and that you become aware of applicable state and local laws that may affect use of electronic devices while driving.

## Entertainment Systems

1. **CD slot:** To insert a CD, press LOAD. Wait to insert a CD until the system displays LOAD CD #. When the system is ready, insert a CD, label side up.



2. **SEEK:** Press to access the next/previous radio station or CD track. Press and hold to advance/reverse in the current CD track.



3. **TUNE/CAT:** Press to manually go up or down the radio frequency.



TEXT is only available when equipped with Satellite radio. Your system may be equipped with Satellite ready capability. The kit to enable Satellite reception is available through your dealer. Detailed Satellite instructions are included with the dealer installed kit. *Check with your authorized dealer for availability.*

4. **MUTE:** Press to mute the playing media. Press again to return to the playing media or turn the volume control to adjust the volume.



5. **Eject:** Press to eject CD(s) when the ignition is on or off. Numbers will illuminate in the display indicating which CD slots are loaded with CDs. To eject a specific CD, press eject and the corresponding preset number. If no preset is selected, the system will eject the currently selected CD. Press and hold to eject all loaded discs.



**Note:** If the CD is not removed within 15 seconds, the system will reload the disc and begin play if the system is on.

6. **BASS:** Press BASS; then press ◀ SEL-TEXT ▶ to decrease/increase the level of bass output.



**TREB (Treble):** Press TREB; then press ◀ SEL-TEXT ▶ to decrease/increase the level of treble output.



## Entertainment Systems

7. **BAL (Balance):** Press BAL; then press ◀ SEL-TEXT ▶ to shift sound to the left/right speakers.

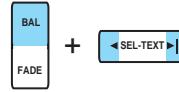

**FADE:** Press FADE; then press ◀ SEL-TEXT ▶ to shift sound to the rear/front speakers.



8. **SEL-TEXT:** Use with Bass, Treble, Balance, Fade and other menu functions.



**TEXT:** TEXT is only available when equipped with Satellite radio. Your system may be equipped with Satellite ready capability. The kit to enable Satellite reception is available through your dealer. Detailed Satellite instructions are included with the dealer installed kit. *Check with your authorized dealer for availability.*

9. **MENU:** Press MENU repeatedly to access RDS ON/OFF.



Use ◀ SEL-TEXT ▶ to switch

RDS ON/OFF. Press MENU again to access Program type mode or Show Type mode. (MENU must be pressed within 10 seconds to proceed to the next RDS mode.)

The Federal Communications Commission (FCC) and the Canadian Radio and Telecommunications Commission (CRTC) recommend that FM radio broadcasters use RDS technology to transmit information. FM radio stations are independently operated and individually elect to use RDS technology to transmit station ID and program type as desired.

**FIND Program type:** Allows you to search RDS-equipped stations for a certain category of music format: Classic, Country, Info, Jazz, Oldies, R&B, Religious, Rock, Soft, Top 40.

With RDS ON, press MENU until the program type menu is displayed.

One of the various program types will appear. Press ◀ SEL-TEXT ▶ to scroll through music types. Press SEEK or SCAN to search for a station playing the requested music category.

**Show TYPE:** Selects between displaying the station's call letters or music format when RDS is enabled. Press MENU until SHOW XX appears in the display. Press to select NAME or TYPE.

## Entertainment Systems

**Compression:** Brings soft and loud CD passages together for a more consistent listening level when in CD mode. Press MENU until compression status is displayed. Press ◀ SEL-TEXT ▶ to enable the compression feature when COMPRESS OFF is displayed. Press the SEL control again to disable the feature when COMPRESS ON is displayed. When activated, the compression icon will illuminate in the display.

**Occupancy mode** (if equipped): Press MENU until occupancy mode appears in the display. Press ◀ SEL-TEXT ▶ to select ALL SEATS, DRIVERS SEAT or REAR SEATS occupancy mode.

**Autoset:** Allows you to set the strongest local radio stations without losing your original manually set preset stations for AM/FM1/FM2. Press MENU until AUTOSSET appears in the display. Press ◀ SEL-TEXT ▶ to turn ON or OFF. When the six strongest stations are filled, the station stored in preset 1 will begin playing. If there are less than six strong stations, the system will store the last one in the remaining presets. When activated, AUTOSSET will appear in the display when any of the preset controls are pressed.

**Speed sensitive volume:** Radio volume changes automatically and slightly with vehicle speed to compensate for road and wind noise. Recommended level is 1–3. Level 0 turns the feature off and level 7 is the maximum setting.

Press MENU to access and use ◀ SEL-TEXT ▶ to adjust the volume setting. The level will appear in the display.

**Setting the clock:** Press MENU until SELECT HOUR or SELECT MINS is displayed. Press ◀ SEL-TEXT ▶ to increase/decrease the hours/minutes. Press MENU again to disengage clock mode.

10. **Memory presets:** To set a station: Select frequency band, tune to a station, press and hold a preset button until sound returns. In CD mode, press to select a specific CD to play.

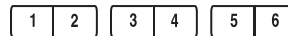

11. **On/Off/Volume:** Press to turn on/off; turn to adjust the volume levels.

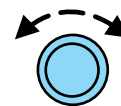

**Note:** With the ignition off, you may press the volume control to momentarily view the clock.



## Entertainment Systems

12. **LOAD:** Press to load a CD.

Press LOAD and a specific preset to load in that particular slot. Available slots are indicated by small flashing indicators in the display. When the system is ready to accept a disc, LOAD CD X will appear in the display. Load the CD. Press and hold to autoloading up to 6 discs.



**Note:** Ensure that the system is ready to accept the CD. Do not force the disc into the CD slot as damage could result.

13. **AM/FM:** Press repeatedly to switch between AM/FM1/FM2 mode.



14. **CD:** Press to enter CD mode. Press CD and a preset to select a specific CD to play.



15. **SAT:** Your system may be equipped with Satellite Ready capability. The kit to enable the Satellite reception is available through your authorized dealer. Detailed satellite instructions are included with the dealer installed kit.

*Check with your authorized dealer for availability.*

16. **SHUF (Shuffle) /SCAN:** Press SCAN to hear a brief sampling of radio stations or CD tracks on the current CD. Press again to stop.

**SHUF (Shuffle):** Press and hold to play the CD tracks in random order for the CD currently being played. Press again to stop.

### GENERAL AUDIO INFORMATION

**Radio frequencies:** AM and FM frequencies are established by the Federal Communications Commission (FCC) and the Canadian Radio and Telecommunications Commission (CRTC). Those frequencies are:

AM - 530, 540–1700, 1710 kHz

FM- 87.7, 87.9–107.7, 107.9 MHz

**Radio reception factors:** There are three factors that can affect radio reception:

- Distance/strength: The further you travel from a station, the weaker the signal and the weaker the reception.
- Terrain: Hills, mountains, tall buildings, power lines, electric fences, traffic lights and thunderstorms can interfere with your reception.
- Station overload: When you pass a broadcast tower, a stronger signal may overtake a weaker one and play while the weak station frequency is displayed.

## Entertainment Systems

### Cassette player care:

- Use only cassettes that are 90 minutes long or less.
- Tighten very loose tapes by inserting a finger or pencil into the hole and turning the hub.
- Remove loose labels before inserting tapes.
- Allow tapes which have been subjected to extreme heat, humidity or cold to reach a moderate temperature before playing.
- Clean the cassette player head with a cassette cleaning cartridge after 10–12 hours of play to maintain good sound/operation.

### Don't:

- Expose tapes to direct sunlight, extreme humidity, heat or cold.
- Leave tapes in the cassette player for a long time when not being played.

### CD/CD player care:

#### Do:

- Handle discs by their edges only. Never touch the playing surface.
- Inspect discs before playing. Clean only with an approved CD cleaner and wipe from the center out.

#### Don't:

- Expose discs to direct sunlight or heat sources for extended periods of time.
- Clean using a circular motion.

**CD units are designed to play commercially pressed 4.75 in (12 cm) audio compact discs only. Due to technical incompatibility, certain recordable and re-recordable compact discs may not function correctly when used in Ford CD players. Dirty, warped or damaged CDs, irregular shaped CDs, CDs with a scratch protection film attached, and CDs with homemade paper (adhesive) labels should not be inserted into the CD player. The label may peel and cause the CD to become jammed. It is recommended that homemade CDs be identified with permanent felt tip marker rather than adhesive labels. Ballpoint pens may damage CDs. Please contact your authorized dealer for further information.**

**Audio system warranty and service:** Refer to the *Warranty Guide/Customer Information Guide* for audio system warranty information. If service is necessary, see your dealer or qualified technician.

## Climate Controls

### MANUAL HEATING AND AIR CONDITIONING SYSTEM (IF EQUIPPED)

1. **Fan speed adjustment:** Controls the volume of air circulated in the vehicle.

2. **Temperature selection:** Controls the temperature of the airflow in the vehicle.

3. **Air flow selections:** Controls the direction of the airflow in the vehicle. See the following for a brief description on each control.

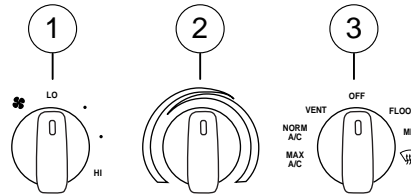

**MAX A/C:** Uses recirculated air to cool the vehicle. Air flows from the instrument panel vents only. This mode will help prevent unpleasant odors from entering the vehicle.

**NORM A/C:** Uses outside air to cool the vehicle. Air flows from the instrument panel vents only.

**VENT:** Distributes outside air through the instrument panel vents.

**OFF:** Outside air is shut out and the fan will not operate.

**FLOOR:** Distributes outside air through the floor vents.

**MIX:** Distributes outside air through the windshield defroster vents, floor vents and side window demisters.

 : Distributes outside air through the windshield defroster vents and the side window demisters.

### Operating tips

- To reduce fog build-up on the windshield during humid weather, place the air flow selector in the  position.
- To reduce humidity build-up inside the vehicle: do not drive with the air flow selector in OFF or MAX A/C.
- Under normal weather conditions, do not leave the air flow selector in MAX A/C or OFF when the vehicle is parked. This allows the vehicle to “breathe” using the outside air inlet vents.
- Do not put objects under the front seats that will interfere with the airflow to the back seats.
- Remove any snow, ice or leaves from the air intake area at the base of the windshield.

## Climate Controls

- A small amount of air may be felt from the floor vent regardless of the air distribution setting that is selected.

During extreme high ambient temperatures when idling stationary for extended periods of time in gear, it is recommended to run the A/C in the MAX A/C position reduce blower fan speed from the highest setting and put the vehicle's transmission into the park gear position to continue to receive cool air from your A/C system.

To aid in side window defogging/demisting in cold weather:

1. Select NORM A/C.
2. Adjust the temperature control to maintain comfort.
3. Set the fan speed to HI.
4. Direct the outer instrument panel vents towards the side windows.

To increase airflow to the outer instrument panel vents, close the vents located in the middle of the instrument panel.

### ELECTRONIC AUTOMATIC TEMPERATURE CONTROL (EATC) SYSTEM (IF EQUIPPED)

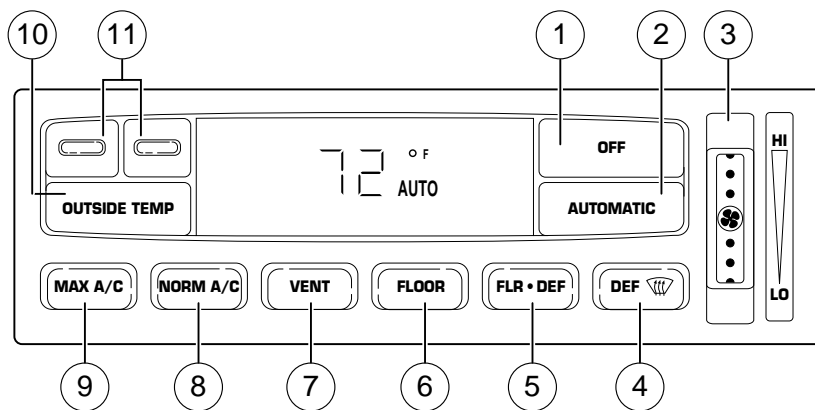

1. **OFF:** Outside air is shut out and the fan will not operate.
2. **AUTOMATIC:** Press AUTOMATIC and select the desired temperature using the temperature controls. The system will automatically determine fan speed, airflow location, and outside or recirculated air to heat or cool the vehicle to the selected temperature. The fan speed will remain automatic unless the thumbwheel is turned all the way to LO.

## Climate Controls

3. **Fan speed:** Turn to manually increase or decrease fan speed.
4. **DEF**  (**Defrost**): Distributes outside air through the windshield defroster vents and the side window demisters.
5. **FLR/DEF (Floor/defrost)**: Distributes outside air through the windshield defroster vents, floor vents and the side window demisters.
6. **FLOOR:** Distributes outside air through the floor vents.
7. **VENT:** Distributes outside air through the instrument panel vents.
8. **NORM A/C:** Uses outside air to cool the vehicle. Air flows from the instrument panel vents only.
9. **MAX A/C:** Uses recirculated air to cool the vehicle. Air flows from the instrument panel vents only. This mode will help prevent unpleasant odors from entering the vehicle.
10. **OUTSIDE TEMP:** Press to display the outside temperature. It will remain in the display until pressed again. The temperature will be most accurate when the vehicle is in motion.
11. **Temperature control:** Press this control to select the temperature. The display window indicates the selected temperature.

**Fahrenheit/Celsius temperature:** Press MAX A/C and DEF  simultaneously to toggle between Fahrenheit and Celsius temperature. The set point temperatures in Celsius will be displayed in half-degree increments.

### Operating tips

- To reduce fog build-up on the windshield during humid weather, place the air flow selector in the  position.
- To reduce humidity build-up inside the vehicle: do not drive with the air flow selector in OFF or MAX A/C.
- Under normal weather conditions, do not leave the air flow selector in MAX A/C or OFF when the vehicle is parked. This allows the vehicle to “breathe” using the outside air inlet vents.
- Do not put objects under the front seats that will interfere with the airflow to the back seats.
- Remove any snow, ice or leaves from the air intake area at the base of the windshield.
- A small amount of air may be felt from the floor vent regardless of the air distribution setting that is selected.

## Climate Controls

During extreme high ambient temperatures when idling stationary for extended periods of time in gear, it is recommended to run the A/C in the MAX A/C position reduce blower fan speed from the highest setting and put the vehicle's transmission into the park gear position to continue to receive cool air from your A/C system.

To aid in side window defogging/demisting in cold weather:

1. Select NORM A/C.
2. Adjust the temperature control to maintain comfort.
3. Set the fan speed to HI.
4. Direct the outer instrument panel vents towards the side windows.

To increase airflow to the outer instrument panel vents, close the vents located in the middle of the instrument panel.

### REAR WINDOW DEFROSTER

The rear defroster control is located on the instrument panel.

Press the rear defroster control to clear the rear window of thin ice and fog. A small LED will illuminate when the rear defroster is activated.

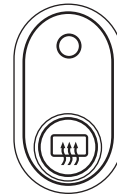

The ignition must be in the on position to operate the rear window defroster.

The defroster turns off automatically after a predetermined amount of time or when the ignition is turned off. To manually turn off the defroster, press the control again.

Activating the rear window defroster will also activate the heated mirrors (if equipped). For more information refer to *Heated outside mirrors* in the *Driver Controls* chapter.

**Do not use razor blades or other sharp objects to clean the inside of the rear window or to remove decals from the inside of the rear window. This may cause damage to the heated grid lines and will not be covered by your warranty.**

## Lights

### HEADLAMP CONTROL

- Turns the lamps off.
- ☰☉☰ Turns on the parking lamps, instrument panel lamps, license plate lamps and tail lamps.
- ☰☉ Turns the headlamps on.

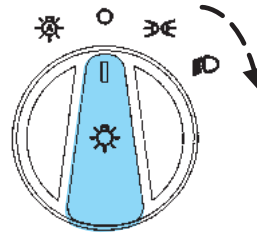

### Autolamp control (if equipped)

The autolamp system provides light sensitive automatic on-off control of the exterior lights normally controlled by the headlamp control.

The autolamp system also keeps the lights on for a predetermined period of time after the ignition switch is turned to off. The delay period can be adjusted up to a maximum of approximately three minutes in duration.

- To turn autolamps on, rotate the control counterclockwise to the next position from off.
- To turn autolamps off, rotate the control clockwise.

The headlamps will also turn on when the wipers are turned on.

To change the duration of the autolamp delay, perform the following sequence:

**Note:** Steps 2 through 5 must be carried out within a 10 second period.

1. Start with the ignition switch in the off position and the headlamp switch in the autolamp position.
2. Place the headlamp switch in the off position.
3. Place the ignition switch in the on position and then back to off.
4. Place the headlamp switch in the autolamp position.
- At this point, the exterior lamps turn on.
5. At the desired autolamp time delay, place the headlamp switch in the off position.
- At this point, the exterior lamps turn off and the time delay is set.

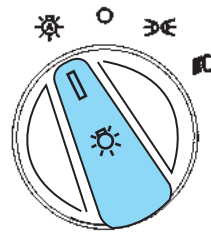

## Lights

### Fog lamp control (if equipped)

With the ignition on, the fog lamps can be turned on when the headlamp control is pulled toward you and is in any of the following positions:

- Parking lamps
- Low beams
- Autolamps (when active)

Fog lamps will turn off when the high beams are activated.

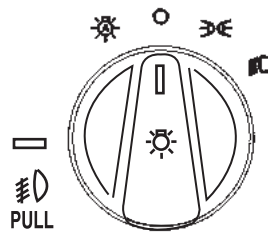

### High beams

- Push the lever toward the instrument panel to activate.
- Pull the lever toward you to deactivate.

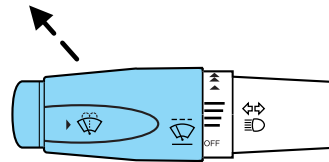

### Flash-to-pass

Pull toward you slightly to activate and release to deactivate.

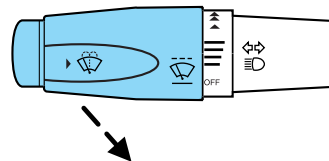

### Daytime running lamps (DRL) (if equipped)

Turns the headlamps on with a reduced output. To activate:

- the key must be in the on position,
- the headlamp control is in the off or  position,
- the vehicle is not in P (Park).



## Lights



**WARNING:** Always remember to turn on your headlamps at dusk or during inclement weather. The Daytime Running Light (DRL) System does not activate your tail lamps and generally may not provide adequate lighting during these conditions. Failure to activate your headlamps under these conditions may result in a collision.

### PANEL DIMMER CONTROL

Use to adjust the brightness of the instrument panel during headlamp and parking lamp operation.

- Rotate the thumbwheel from left to right to brighten the instrument panel.
- Rotate the thumbwheel from right to left to dim the instrument panel.

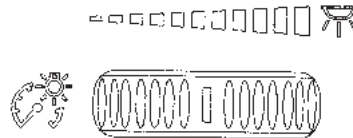

### Dome lamp control

The panel dimmer control also controls the dome lamp operation.

- Rotate the thumbwheel fully to the right, past detent, to activate the dome lamp.
- In order to turn off the dome lamp, rotate the thumbwheel to the left.

### AIMING THE HEADLAMPS

The headlamps on your vehicle are properly aimed at the assembly plant. If your vehicle has been in an accident, the alignment of your headlamps should be checked by your authorized dealer.

#### Headlamp aim adjustment (Crown Victoria only)

The headlamps are designed to be mechanically aimed, but can also be aimed visually by doing the following:

1. Park the vehicle directly in front of a wall or screen on a level surface, approximately 25 feet (7.6 meters) away. Check your headlamp alignment at night or in a dark area so that you can see the headlamp beam pattern.

## Lights

- (1) 8 feet (2.4 meters)
- (2) Center height of lamp to ground
- (3) 25 feet (7.6 meters)
- (4) Horizontal reference line
- (5) Center of headlamps
- (6) Center line of the vehicle

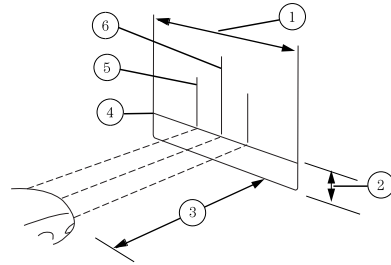

2. The center of the headlamp is marked either on the lens (a circle or cross marker) or on the bulb shield, internal to the lamp (mark or feature). Measure the height from the center of your headlamp to the ground (2) and mark an 8 foot (2.4 meter) long horizontal line on the wall or screen (1) at this height (masking tape works well).

3. Turn on the low beam headlamps and open the hood.

4. Locate the high intensity area of the beam pattern and place the top edge of the intensity zone even with the horizontal reference line (4). If the top edge of the high intensity area is not even with the horizontal line, follow the next step to adjust it.

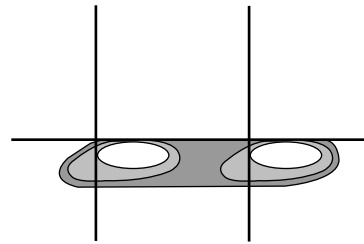

5. Locate the vertical adjuster for each headlamp. Adjust the aim by turning the adjuster control either clockwise (to adjust down) or counterclockwise (to adjust up).

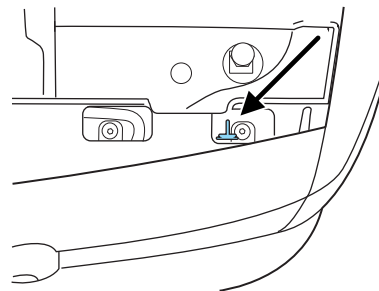

6. In addition to the horizontal line marked in step 2, a pair of vertical lines (5) must be marked at the center line of the headlamps on the wall or screen.

7. On the wall or screen, locate the high intensity area of the beam pattern. The left edge of the high intensity area should be even with the vertical line corresponding to the headlamp under adjustment. If the left edge of the high intensity area is not even with the vertical line, follow the next step to adjust it.

## Lights

8. Locate the horizontal adjuster for each headlamp. Turn it clockwise or counterclockwise and place the left edge of the high intensity area even with the vertical line corresponding to the headlamp under adjustment.

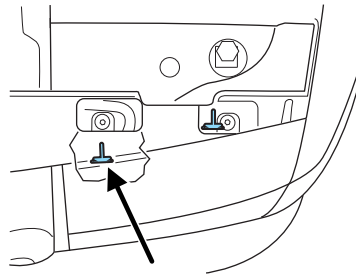

### Vertical aim adjustment (Grand Marquis only)

1. Park the vehicle directly in front of a wall or screen on a level surface, approximately 25 feet (7.6 meters) away. Check your headlamp alignment at night or in a dark area so that you can see the headlamp beam pattern.

- (1) 8 feet (2.4 meters)
- (2) Center height of lamp to ground
- (3) 25 feet (7.6 meters)
- (4) Horizontal reference line

2. Measure the height of the headlamp bulb center from the ground and mark an 8 foot (2.4 meter) horizontal reference line on the vertical wall or screen at this height (a piece of masking tape works well).

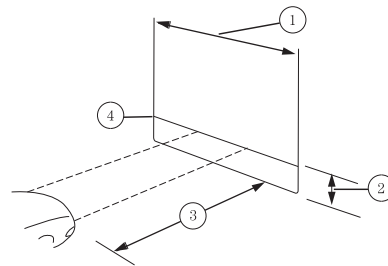

3. Turn on the low beam headlamps to illuminate the wall or screen and open the hood.

4. On the wall or screen you will observe an area of high intensity light. The top of the high intensity area should touch the horizontal reference line, if not, the beam will need to be adjusted.

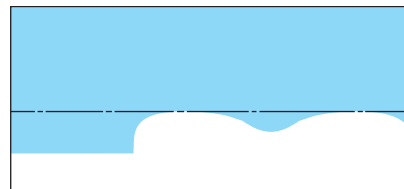

## Lights

To see a clearer light pattern for adjusting, you may want to block the light from one headlamp while adjusting the other.

5. Locate the vertical adjuster on each headlamp. Using a 4 mm wrench, turn the adjuster either clockwise (to adjust down) or counterclockwise (to adjust up). The horizontal edge of the brighter light should touch the horizontal reference line.

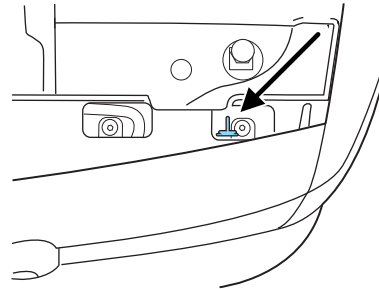

6. Close the hood and turn off the lamps.

HORIZONTAL AIM IS NOT REQUIRED FOR THIS VEHICLE AND IS NON-ADJUSTABLE.

### TURN SIGNAL CONTROL

- Push down to activate the left turn signal.
- Push up to activate the right turn signal.

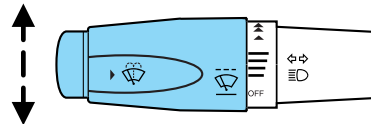

The flash rate of the turn signal will speed up considerably if the left or right turn lamp bulb (front or rear) is burned out.

### INTERIOR LAMPS

#### Map/courtesy lamps

The courtesy lamps light when:

- any door is opened.
- the instrument panel dimmer switch is rotated past the detent.
- the unlock control of the remote entry controls is pressed and the ignition is off.

The reading lamps can be turned on by pressing the rocker controls next to each lamp.

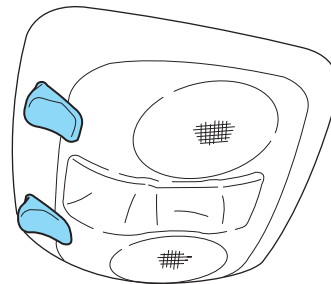

## Lights

If equipped with remote keyless entry, the courtesy lamp will illuminate whenever any door is opened and will remain on for 25 seconds after the door is shut or when the ignition is turned to the on position.

### Rear courtesy/reading lamps (if equipped)

Rotate the lens to illuminate the lamp. With the lens in the flat position, the courtesy lamp lights when:

- any door is opened.
- the panel dimmer thumbwheel is rotated fully to the right, past detent.

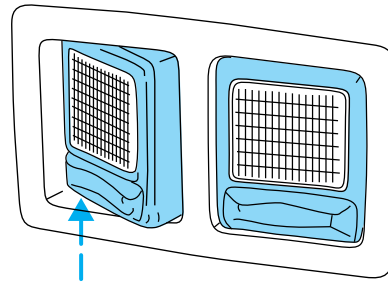

## BULB REPLACEMENT

### Lamp assembly condensation

Exterior lamps are vented to accommodate normal changes in pressure. Condensation can be a natural by-product of this design. When moist air enters the lamp assembly through the vents, there is a possibility that condensation can occur when the temperature is cold. When normal condensation occurs, a thin film of mist can form on the interior of the lens. The thin mist eventually clears and exits through the vents during normal operation. Clearing time may take as long as 48 hours under dry weather conditions.

Examples of acceptable condensation are:

- Presence of thin mist (no streaks, drip marks or droplets)
- Fine mist covers less than 50% of the lens

Examples of unacceptable moisture (usually caused by a lamp water leak) are:

- Water puddle inside the lamp
- Large water droplets, drip marks or streaks present on the interior of the lens

Take your vehicle to a dealer for service if any of the above conditions of unacceptable moisture are present.

## Lights

### Using the right bulbs

Replacement bulbs are specified in the chart below. Headlamp bulbs must be marked with an authorized "D.O.T." for North America and an "E" for Europe to ensure lamp performance, light brightness and pattern and safe visibility. The correct bulbs will not damage the lamp assembly or void the lamp assembly warranty and will provide quality bulb burn time.

Function	Trade Number
*Headlamp	9007
*Park lamp and turn lamp (front)	3457 AK (amber)
*Side marker (front)	194 AK (amber)
*Tail, stop, turn (rear)	3157K
*Side marker (rear)	194
**Headlamp	H13
**Park, turn and sidemarker lamp (front)	3157 AK (amber)
**Cornering lamp (front)	3156K
**Tail, stop turn and sidemarker lamp (rear)	3157K
**Fog lamp	9145
Backup lamp	3156K
License plate lamp	168
High-mount brakelamp	912
Luggage compartment lamp	212-2
Rear reading lamp	578
Map lamp	906
Dual floorwell lamp	906
Glove compartment	168
Visor vanity lamp - Slide on Rail system (SOR)	A6224PF
All replacement bulbs are clear in color except where noted.	
To replace all instrument panel lights - see your authorized dealer.	
*Crown Victoria only	
**Grand Marquis only	

### Replacing interior bulbs

Check the operation of all bulbs frequently.

### Replacing exterior bulbs

Check the operation of all bulbs frequently.

### Replacing headlamp bulbs (Crown Victoria only)

To remove the headlamp bulb:

1. Make sure the headlamp switch is in the off position, then open the hood.
2. Remove the radiator cover by turning the three retainers to the unlock position.
3. Remove the two retainers and pull headlamp assembly forward to expose bulb.

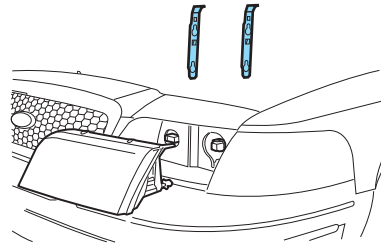

4. Disconnect the electrical connector from the bulb by pulling rearward.

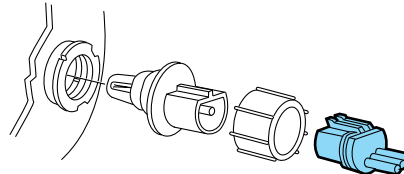

5. Remove the bulb retaining ring by rotating it counterclockwise (when viewed from the rear) to free it from the bulb socket, and slide the ring off the plastic base. Keep the ring to retain the new bulb.

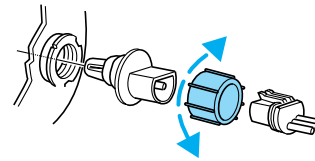

6. Without turning, remove the old bulb from the lamp assembly by gently pulling it straight back out of the lamp assembly.

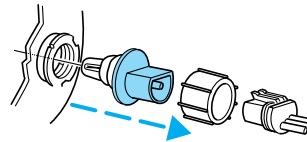

## Lights

To install the new bulb:



**WARNING:** Handle a halogen headlamp bulb carefully and keep out of children's reach. Grasp the bulb only by its plastic base and do not touch the glass. The oil from your hand could cause the bulb to break the next time the headlamps are operated.

**Note:** If the bulb is accidentally touched, it should be cleaned with rubbing alcohol before being used.

1. With the flat side of the new bulb's plastic base facing upward, insert the glass end of the bulb into the lamp assembly. Turn the bulb left or right to align the grooves in the plastic base with the tabs in the lamp assembly. When the grooves are aligned, push the bulb into the lamp assembly until the plastic base contacts the rear of the lamp assembly.
2. Install the bulb retaining ring over the plastic base until it contacts the rear of the socket by rotating it clockwise until you feel a "stop."
3. Connect the electrical connector into the rear of the plastic base until it snaps, locking it into position.
4. Install the headlamp assembly with two retainers.
5. Install the radiator cover locking it in place with three retainers.
6. Turn the headlamps on and make sure they work properly. If the headlamp was correctly aligned before you changed the bulb, you should not need to align it again.

### **Replacing front parking/turn signal lamp bulbs**

To remove the front parking/turn signal lamp bulbs:

1. Make sure headlamp switch is in the off position, then open the hood.
2. Remove the radiator cover by turning the three retainers to the unlock position.



## Lights

3. Remove two retainers and pull headlamp assembly forward to expose bulb.
4. Remove the bulb socket by rotating it counterclockwise, then pulling it out of the lamp assembly.

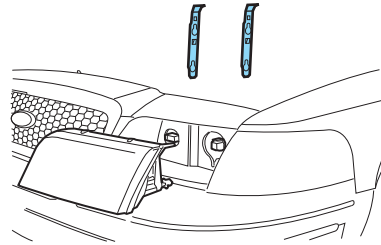

5. Pull the bulb from the socket and push in the new bulb.
6. Install the bulb socket into the lamp assembly by rotating it clockwise.

To complete installation, follow the removal procedure in reverse order.

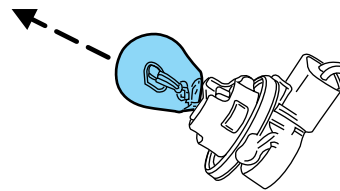

### **Replacing front sidemarker bulb**

To remove the front side marker bulb:

1. Make sure headlamp switch is in the off position, then open the hood.
2. Remove the radiator cover by turning the three retainers to the unlock position.
3. Remove the screw from the outside of the lamp.
4. Remove the nut from inside the lamp and pull the lamp assembly away from the vehicle.

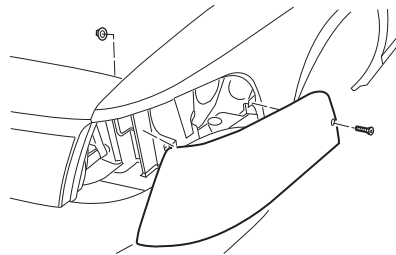

## Lights

5. Rotate the bulb socket counterclockwise and remove from lamp assembly.
6. Carefully pull bulb straight out of the socket and push in the new bulb until it snaps, locking it into position.
7. To complete installation, follow the removal procedure in reverse order.

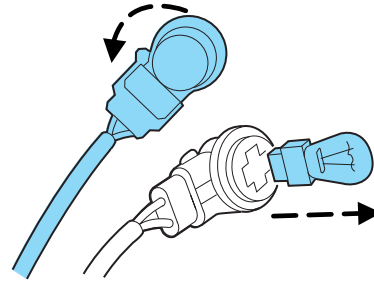

### **Replacing tail/brake/turn signal lamp bulbs**

The tail lamp and brake/turn signal lamp bulbs are located in the tail lamp assembly. Follow the same steps to replace either bulb.

1. Make sure the headlamp switch is in the off position, then open the trunk and remove the retainer.
2. Carefully pull the carpet away to expose the lamp assembly hardware.
3. Remove three nuts and the lamp assembly from the vehicle.
4. Remove the bulb socket by rotating it counterclockwise, then pulling it out of the lamp assembly.

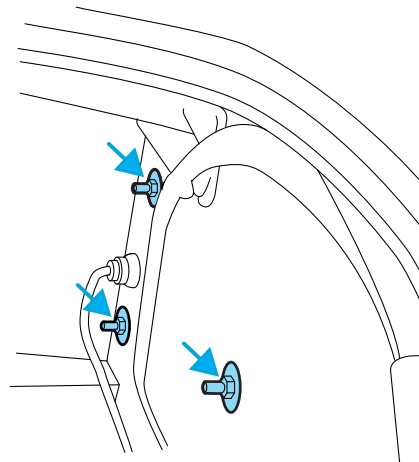

5. Pull the bulb from the socket and push in the new bulb.
6. Install the bulb socket into the lamp assembly by rotating it clockwise.
7. Install the lamp assembly on the vehicle with three nuts ensuring the nuts are flush with the body to prevent water from entering the trunk.

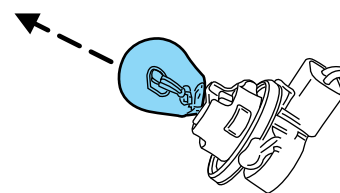

## Lights

8. Carefully push the carpet back in to place and install the retainer.

### **Replacing license plate lamp bulbs**

1. Make sure headlamp switch is in the off position, then remove two screws, grommets and the license plate lamp assembly from the trunk lid.

2. Carefully pull the bulb from the socket and push in the new bulb.

3. Install the lamp assembly on trunk lid with two grommets, ensuring the grommets are pushed all the way into the trunk lid and secure with two screws.

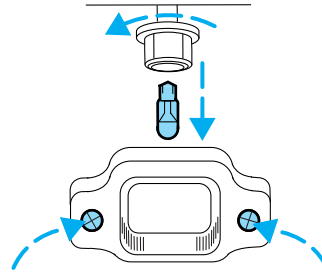

### **Replacing backup lamp bulbs**

1. Open trunk and remove bulb socket from the trunk lid by turning counterclockwise.

2. Pull the bulb straight out of the socket and push in the new bulb.

3. Install the bulb socket in trunk lid by turning clockwise.

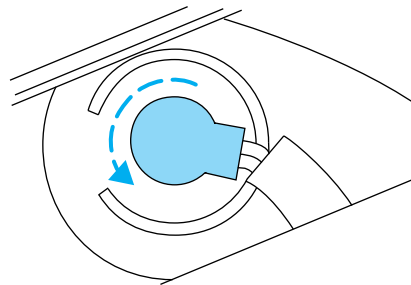

### **Replacing high-mount brakelamp bulbs**

1. Remove two screws from the lamp assembly.

2. Carefully lift the lamp assembly up for access to the bulbs.

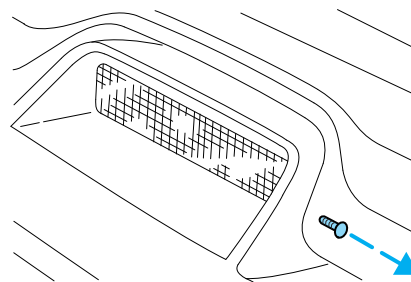

## Lights

3. Carefully pull the bulb socket out of the lamp assembly.

4. Pull the bulb straight out of the socket and push in the new bulb.

To install, reverse the removal procedure.

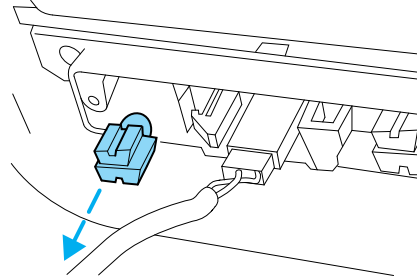

### Replacing headlamp bulbs (Grand Marquis only)

To remove the headlamp bulb:

1. Make sure the headlamp control is in the off position, then open the hood.

2. Remove the three pin type retainers and the radiator sight shield.

3. Remove the front parking lamp assembly. Refer to *Replacing front parking/cornering/turn signal lamp bulbs* in this section.

4. Remove the headlamp retainer bolts and the headlamp assembly.

5. Disconnect the electrical connector.

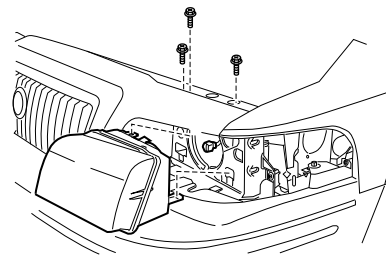

6. Remove the old headlamp bulb by rotating it counterclockwise, then pull it out.

7. To install, reverse the removal procedure. (Re-aiming the headlamps may be necessary. For additional information, refer to the headlamp aiming section in this chapter.)

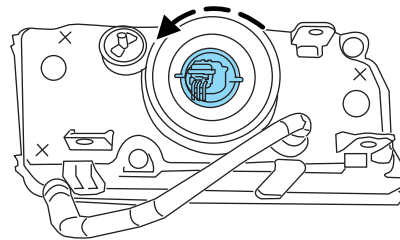

## Lights

 **WARNING:** Handle a halogen headlamp bulb carefully and keep out of children's reach. Grasp the bulb only by its plastic base and do not touch the glass. The oil from your hand could cause the bulb to break the next time the headlamps are operated.

**Note:** If the bulb is accidentally touched, it should be cleaned with rubbing alcohol before being used.

**Note:** The headlamp bulb should not be removed from the headlamp until just before a replacement bulb is installed. Removing the bulb for an extended period of time may affect headlamp bulb performance. Contaminants may enter the headlamp where they can settle on the lens and reflector. Never turn the headlamps on with the bulb removed.

### **Replacing front parking/cornering/turn signal lamp bulbs**

To remove the parking/cornering/turn signal lamp bulbs:

1. Make sure the headlamp switch is in the off position, then open the hood.
2. Remove the three pin type retainers and the radiator shield.
3. Remove two nuts from the back side of the lamp assembly, then pull the lamp assembly away from the vehicle.

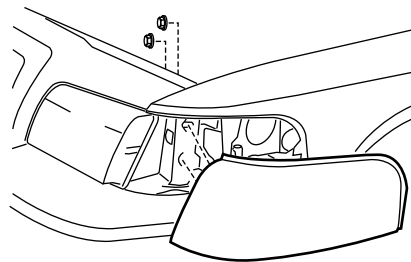

4. Rotate the bulb socket counterclockwise and remove it from the lamp assembly.
5. Carefully pull bulb straight out of the socket and push in the new bulb.
6. To install, reverse the order of the removal procedure.

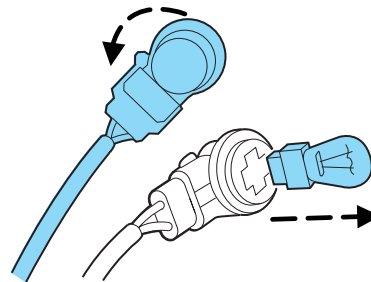

## Lights

**Note:** The parking lamp/turn signal bulbs should not be removed from the lamp until just before a replacement bulb is installed. Removing the bulb for an extended period of time may affect headlamp bulb performance. Contaminants may enter the headlamp where they can settle on the lens and reflector. Never turn the lamps on with the bulb removed.

### **Replacing tail/brake/turn signal lamp bulbs**

The tail lamp, the brake lamp and the turn signal lamp bulbs are located in the tail lamp assembly. Follow the same steps to replace either bulb.

1. Make sure the headlamp switch is in the off position, then open the trunk, remove pin-type retainer and carefully pull the carpet away to expose the lamp assembly hardware.
2. Remove the three nuts and the lamp assembly from the vehicle.
3. Remove the bulb socket by rotating it counterclockwise, then pulling it out of the lamp assembly.

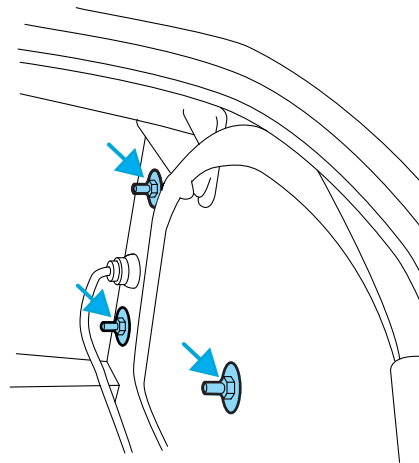

4. Pull the bulb from the socket and push in the new bulb.
5. Install the bulb socket into the lamp assembly by rotating it clockwise.
6. Install the lamp assembly on the vehicle with three nuts, ensuring the nuts are flush with the body to prevent water from entering the trunk.
7. Carefully push the carpet back in to place and install the pin-type retainer.

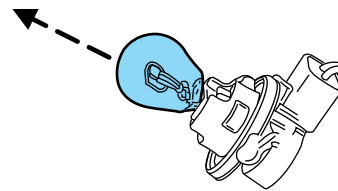

## Lights

### **Replacing license plate lamp bulbs**

1. Make sure the headlamp switch is in the off position, then remove two screws, grommets and the license plate lamp assembly from the trunk lid.
2. Carefully pull the bulb from the socket and push in the new bulb.
3. Install the lamp assembly on the trunk lid with two grommets, ensuring that the grommets are pushed all the way in to the trunk lid and secured with two screws.

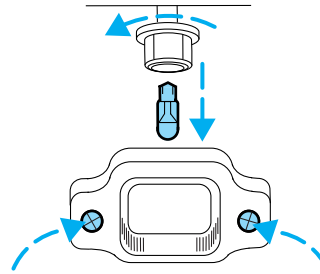

### **Replacing backup lamp bulbs**

1. Open the trunk, then remove the bulb socket from the trunk lid by turning it counterclockwise.
2. Pull the bulb straight out of the socket and push in the new bulb.
3. Install the bulb socket in trunk lid by turning clockwise.

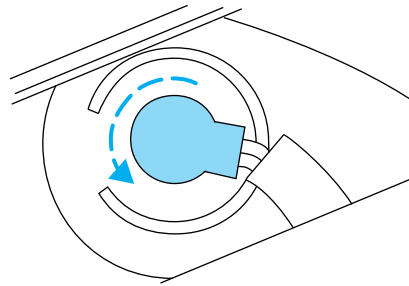

### **Replacing high-mount brakelamp bulbs**

1. Remove two screws from the lamp assembly.
2. Carefully lift the lamp assembly up for access to the bulbs.

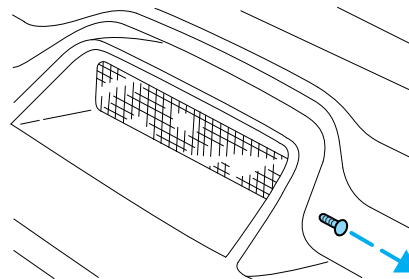

## Lights

3. Carefully pull the bulb socket out of the lamp assembly.

4. Pull the bulb straight out of the socket and push in the new bulb.

To install, reverse the removal procedure.

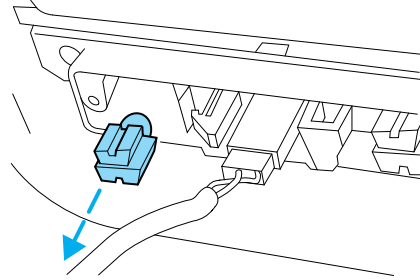



## Driver Controls

### MULTI-FUNCTION LEVER

**Windshield wiper:** Rotate the end of the control away from you to increase the speed of the wipers; rotate towards you to decrease the speed of the wipers.

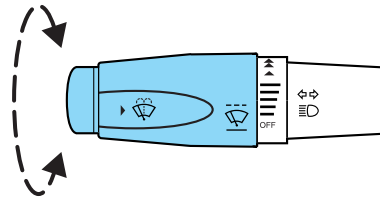

**Windshield washer:** Press the end of the stalk:

- briefly: causes a single swipe of the wipers without washer fluid.
- a quick press and hold: the wipers will swipe three times with washer fluid.
- a long press and hold: the wipers and washer fluid will be activated for up to ten seconds.

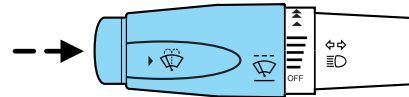

**Courtesy wipe feature:** One extra wipe will occur a few seconds after washing the front window to clear any excess washer fluid remaining on the windshield.

**Note:** Do not operate the washer when the washer reservoir is empty. This may cause the washer pump to overheat. Check the washer fluid level frequently. Do not operate the wipers when the windshield is dry. This may scratch the glass, damage the wiper blades and cause the wiper motor to burn out. Before operating the wiper on a dry windshield, always use the windshield washer. In freezing weather, be sure the wiper blades are not frozen to the windshield before operating the wipers.

### Windshield wiper/washer features

When the windshield wipers are turned on during daylight, and the headlamp control is in the autolamp position, the exterior lamps will turn on after a brief delay and will remain on until the wipers are turned off.

## Driver Controls

### TILT STEERING WHEEL

To adjust the steering wheel:

1. Pull and hold the steering wheel release control toward you.
2. Move the steering wheel up or down until you find the desired location.
3. Release the steering wheel release control. This will lock the steering wheel in position.

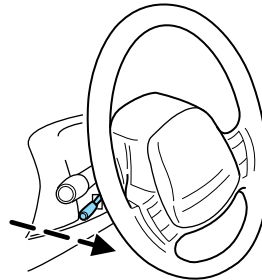

**WARNING:** Never adjust the steering wheel when the vehicle is moving.

### ILLUMINATED VISOR MIRROR (IF EQUIPPED)

Lift the mirror cover to turn on the visor mirror lamps.

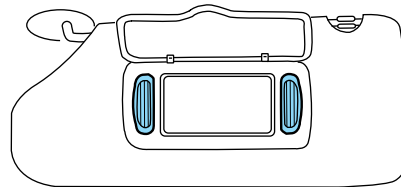

### Slide-on-rod feature (if equipped)

Rotate the visor towards the side window and extend it rearward for additional sunlight coverage.

**Note:** To stow the visor back into the headliner, visor must be retracted before moving it back towards the windshield.

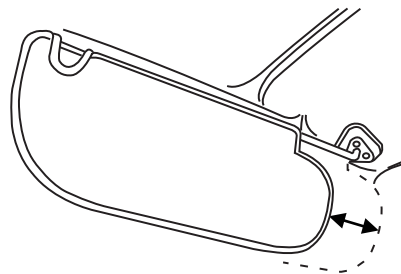

## Driver Controls

### CENTER CONSOLE (IF EQUIPPED)

Your vehicle may be equipped with a variety of console features. These include:

- Utility compartment
- Power point (inside storage bin)
- Cupholders
- Air vents to the rear seating positions (heat only)



**WARNING:** Use only soft cups in the cupholder. Hard objects can injure you in a collision.

### AUXILIARY POWER POINT (12V DC)

**Power outlets are designed for accessory plugs only. Do not insert any other object in the power outlet as this will damage the outlet and blow the fuse. Do not hang any type of accessory or accessory bracket from the plug. Improper use of the power outlet can cause damage not covered by your warranty.**

The auxiliary power point is located under the cup holder and ashtray drawer in the center stack. The auxiliary power point for five passenger vehicles is located in the floor console storage bin.

Do not use the power point for operating the cigarette lighter element (if equipped).

**Note:** Do not plug optional electrical accessories into the cigarette lighter socket (if equipped). Improper use of the lighter can cause damage not covered by your warranty, and can result in fire or serious injury.

To prevent the fuse from being blown, do not use the power point(s) over the vehicle capacity of 12V DC/180W. If the power point or cigar lighter socket is not working, a fuse may have blown. Refer to *Fuses and relays* in the *Roadside Emergencies* chapter for information on checking and replacing fuses.

To have full capacity usage of your power point, the engine is required to be running to avoid unintentional discharge of the battery. To prevent the battery from being discharged:

- do not use the power point longer than necessary when the engine is not running,
- do not leave battery chargers, video game adapters, computers and other devices plugged in overnight or when the vehicle is parked for extended periods.

Always keep the power point caps closed when not being used.

## Driver Controls

### POWER WINDOWS

 **WARNING:** Do not leave children unattended in the vehicle and do not let children play with the power windows. They may seriously injure themselves.

 **WARNING:** When closing the power windows, you should verify they are free of obstructions and ensure that children and/or pets are not in the proximity of the window openings.

Press and pull the window switches to open and close windows.

- Press down (to the first detent) and hold the switch to open.
- Pull up (to the first detent) and hold the switch to close.

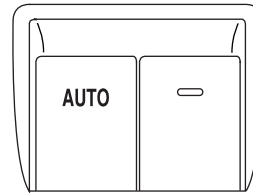

#### One-touch down

Allows the driver's window to open fully without holding the control down. Press the switch completely down to the second detent and release quickly. The window will open fully. Momentarily press the switch to any position to stop the window operation.

#### Window lock

The window lock feature allows only the driver to operate the power windows.

To lock out all the window controls (except for the driver's) press the right side of the control. Press the left side to restore the window controls.

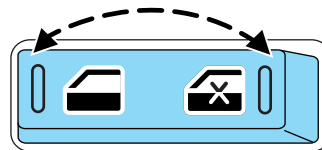

#### Accessory delay

With accessory delay, the power window switches and radio may be used for up to 10 minutes after the ignition switch is turned off or until any door is opened.

## Driver Controls

### INTERIOR MIRROR

The interior rear view mirror has two pivot points on the support arm which lets you adjust the mirror up or down and from side to side.



**WARNING:** Do not adjust the mirror while the vehicle is in motion.

### Automatic dimming interior rear view mirror (if equipped)

The interior rear view mirror has an auto-dimming function. The electronic day/night mirror will change from the normal (high reflective) state to the non-glare (darkened) state when bright lights (glare) reach the mirror. When the mirror detects bright light from behind the vehicle, it will automatically adjust (darken) to minimize glare.

The mirror will automatically return to the normal state whenever the vehicle is placed in R (Reverse) to ensure a bright clear view when backing up.

**Do not block the sensors on the front and back of the interior rear view mirror since this may impair proper mirror performance.**

**Note:** A rear center passenger and/or raised rear center headrest (if equipped) may also block the light from reaching the sensor.

**Do not clean the housing or glass of any mirror with harsh abrasives, fuel or other petroleum-based cleaning products.**

### EXTERIOR MIRRORS

#### Power side view mirrors



**WARNING:** Do not adjust the mirror while the vehicle is in motion.

To adjust your mirrors:

1. Rotate the control clockwise to adjust the right mirror and rotate the control counterclockwise to adjust the left mirror.
2. Move the control in the direction you wish to tilt the mirror.
3. Return to the center position to lock mirrors in place.

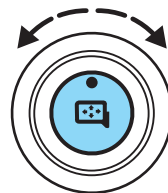

<https://www.MyCarManual.com>

## Driver Controls

### Heated outside mirrors (if equipped)

Both mirrors are heated automatically to remove ice, mist and fog when the rear window defrost is activated.

**Do not remove ice from the mirrors with a scraper or attempt to readjust the mirror glass if it is frozen in place. These actions could cause damage to the glass and mirrors.**

**Do not clean the housing or glass of any mirror with harsh abrasives, fuel or other petroleum-based cleaning products.**

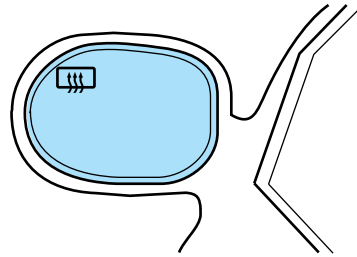

### Fold-away mirrors

Fold the side mirrors in carefully when driving through a narrow space, like an automatic car wash.

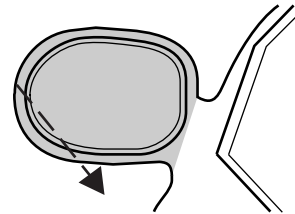

### POWER ADJUSTABLE FOOT PEDALS (IF EQUIPPED)

The accelerator and brake pedal should only be adjusted when the vehicle is stopped and the gearshift lever is in the P (Park) position.

Press and hold the rocker control to adjust accelerator and brake pedal.

- Press the right side of the control to adjust the pedals toward you.
- Press the left side of the control to adjust the pedals away from you.

The adjustment allows for approximately 2.5 inches (65 mm) of maximum travel.

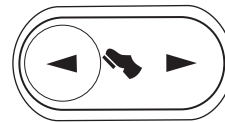

**WARNING:** Never adjust the accelerator and brake pedal with feet on the pedals while the vehicle is moving.

## Driver Controls

### SPEED CONTROL (IF EQUIPPED)

With speed control set, you can maintain a set speed without keeping your foot on the accelerator pedal.



**WARNING:** Do not use the speed control in heavy traffic or on roads that are winding, slippery or unpaved.

### Using speed control

The speed controls are located on the steering wheel; there are two versions. The following buttons work with speed control:

**ON:** Press to turn the speed control on.

**OFF:** Press to turn the speed control off.

**RESUME:** Press to resume a set speed.

**SET +/-:** Press to set a speed or to increase or decrease a set speed.

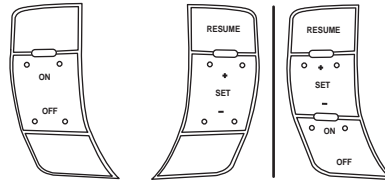

### Setting speed control

4. Press and release ON.
5. Accelerate to the desired speed.
6. Press and release SET +.
7. Take your foot off the accelerator pedal.
8. The indicator  light (if equipped) on the instrument cluster will turn on.

### Note:

- Vehicle speed may vary momentarily when driving up and down a steep hill.
- If the vehicle speed increases above the set speed on a downhill, you may want to apply the brakes to reduce the speed.
- If the vehicle speed decreases more than 10 mph (16 km/h) below your set speed on an uphill, your speed control will disengage.

### Disengaging speed control

Press the brake pedal to disengage the speed control. Disengaging the speed control will not erase previous set speed.

## Driver Controls

### **Resuming a set speed**

Press and release RESUME. This will automatically return the vehicle to the previously set speed.

### **Increasing speed while using speed control**

To set a higher speed:

- Press and hold SET + until you get to the desired speed, then release. You can also use SET + to operate the tap-up function. Press and release SET + to increase the vehicle set speed in 1 mph (1.6 km/h) increments.
- Use the accelerator pedal to get to the desired speed, then press and release SET +.

### **Reducing speed while using speed control**

To reduce a set speed:

- Press and hold SET – until you get to the desired speed, then release. You can also use SET – to operate the tap-down function. Press and release SET – to decrease the vehicle set speed in 1 mph (1.6 km/h) increments.
- Press the brake pedal until the desired vehicle speed is reached, then press and release SET +.

### **Turning off speed control**

To turn off the speed control, press OFF or turn off the ignition.

**Note:** When you turn the speed control or the ignition off, your speed control set speed memory is erased.

## STEERING WHEEL CONTROLS (IF EQUIPPED)

### **Audio control features**

**NEXT:** Press to select the next preset radio station, tape selection or CD track.

**VOL +/- (Volume):** Press to increase or decrease the volume.

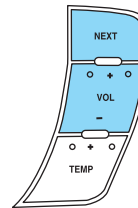



## Driver Controls

### Climate control features

**TEMP +/-:** Press to increase or decrease the interior temperature.

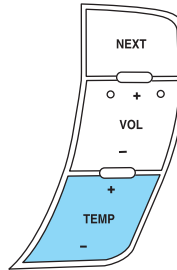

### POSITIVE RETENTION FLOOR MAT

**WARNING:** Do not install additional floor mats on top of the factory installed floor mats as they may interfere with the accelerator or the brake pedals.

Position the floor mat so that the eyelets are over the retention posts and press down to lock in. Make sure that the mat does not interfere with the operation of the accelerator or the brake pedal. To remove the floor mat, reverse the installation procedure.



### INTERIOR TRUNK CONTROL

The remote trunk release control is located on the driver's door trim panel and can be operated at any time.

You can render the switch inoperable by locking the button with your master key.

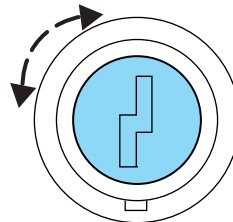



## Locks and Security

### KEYS

The vehicle is equipped with a master key which will access the vehicle's doors, trunk, glove box, ignition and remote trunk release.

### POWER DOOR LOCKS

- Press the  control to unlock all doors.
- Press the  control to lock all doors.

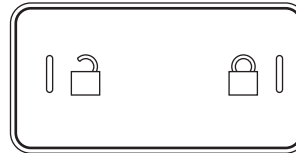

### Smart locks (if equipped)

With the key in any ignition position, and either the driver's or passenger's door open, the doors cannot be locked using the power door lock switches.

The vehicle may still be locked with the key in the ignition, and performing one of the following actions:

- Pressing the manual lock button on the door.
- Operating the remote entry transmitter (if equipped).
- Operating the keyless entry keypad (if equipped).
- Operating the driver's door with a key.

### Autolock (if equipped)

This feature automatically locks all vehicle doors when:

- all doors are closed,
- the engine is running,
- you shift into any gear, putting the vehicle in motion, and
- the vehicle's speed is greater than 3 mph (5 km/h).

### Autorelock

The autolock feature repeats when:

- a door is opened and closed while the engine is running,
- you shift into any gear, putting the vehicle in motion, and
- the vehicle's speed is greater than 3 mph (5 km/h).

## Locks and Security

### **Autounlock**

The autounlock feature will unlock all doors when:

- the ignition has been in the on position, all doors are closed, and the vehicle has been in motion at a speed greater than 12 mph (20 km/h),
- the vehicle has then come to a stop and the ignition is turned to the accessory or off position, and
- the driver door is opened (within 10 minutes after the ignition was transitioned to the accessory or off position).

**Note:** The vehicle doors will not autounlock if the vehicle has been electronically locked prior to the driver door being opened.

### **Deactivating/activating the autolock or autounlock feature**

Automatic door locks can also be turned on/off through the following procedure:

You must complete Steps 1-7 within 30 seconds or the procedure will have to be repeated. If the procedure needs to be repeated, you must wait at least 30 seconds. **Note:** Before following the procedure, make sure that the ignition is in the off position and all vehicle doors, the hood, and the decklid are closed.

1. Turn the ignition to the on position.
2. Press the power door unlock control on the door panel three times.
3. Turn the ignition from the on to the off position.
4. Press the power door unlock control three times.
5. Turn the ignition back to the on position.
6. The door locks will lock/unlock to confirm programming mode is entered/active.
7. With the ignition still in the on position, **for the autolock feature**, press the unlock control once then press the lock control once. The horn will chirp once if autolock was deactivated or twice (one short and one long chirp) if autolock was activated. **For the autounlock feature**, press the lock control once, then press the unlock control once. The horn will chirp once if autounlock was deactivated or twice (one short and one long chirp) if autounlock was activated.

If any door, the hood, or the deck lid is open, the horn will chirp twice, and the procedure will need to be performed again.

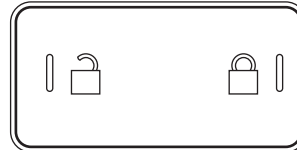

## Locks and Security

8. After having waited the necessary time for the programming to confirm, turn the ignition to the off position.

Once disabled, the autolock or autounlock feature can be enabled by repeating the procedure in Steps 1–8.

### CHILDPROOF DOOR LOCKS

When these locks are set, the rear doors cannot be opened from the inside. The rear doors can be opened from the outside when the doors are unlocked.

The childproof locks are located on rear edge of each rear door and must be set separately for each door. Setting the lock for one door will not automatically set the lock for both doors.

Move lock control up to engage the childproof lock. Move control down to disengage childproof locks.

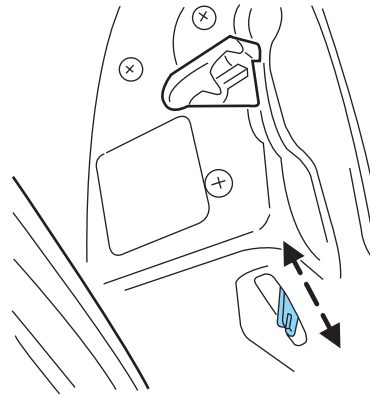

### INTERIOR LUGGAGE COMPARTMENT RELEASE

Your vehicle is equipped with a mechanical interior luggage compartment release handle that provides a means of escape for children and adults in the event they become locked inside the luggage compartment.

Adults are advised to familiarize themselves with the operation and location of the release handle.

## Locks and Security

To open the luggage compartment door (lid) from within the luggage compartment, pull the illuminated “T” shaped handle and push up on the trunk lid. The handle is composed of a material that will glow for hours in darkness following brief exposure to ambient light.

The “T” shaped handle will be located either on the luggage compartment door (lid) or inside the luggage compartment near the tail lamps.

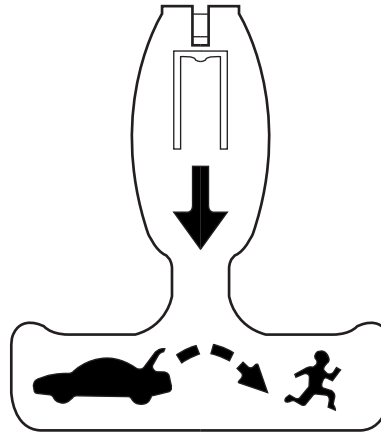

**WARNING:** Keep vehicle doors and luggage compartment locked and keep keys and remote transmitters out of a child's reach. Unsupervised children could lock themselves in the trunk and risk injury. Children should be taught not to play in vehicles.

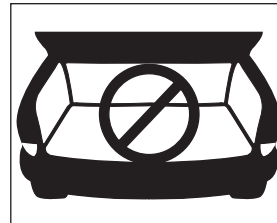

**WARNING:** Do not leave children, unreliable adults, or animals unattended in the vehicle. On hot days, the temperature in the trunk or vehicle interior can rise very quickly. Exposure of people or animals to these high temperatures for even a short time can cause death or serious heat-related injuries, including brain damage. Small children are particularly at risk.

## Locks and Security

### REMOTE ENTRY SYSTEM (IF EQUIPPED)

This device complies with part 15 of the FCC rules and with RSS-210 of Industry Canada. Operation is subject to the following two conditions: (1) This device may not cause harmful interference, and (2) This device must accept any interference received, including interference that may cause undesired operation.

**Changes or modifications not expressly approved by the party responsible for compliance could void the user's authority to operate the equipment.**

The typical operating range for your remote entry transmitter is approximately 33 feet (10 meters). A decrease in operating range could be caused by:



- weather conditions,
- nearby radio towers,
- structures around the vehicle, or
- other vehicles parked next to your vehicle.

The remote entry system allows you to lock or unlock all vehicle doors without a key. **Note:** The remote entry features operate with the ignition in any position except in the on position, when the transmission is in any gear other than P (Park) or N (Neutral).



If there are problems with the remote entry system, make sure to take **ALL remote entry transmitters** with you to the authorized dealer in order to aid in troubleshooting the problem.



### Unlocking the doors

1. Press  and release to unlock the driver's door. **Note:** The interior lamps will illuminate.
2. Press  and release again within five seconds to unlock all the doors.

### Locking the doors

Press  once to lock all the doors. Upon the first press the doors will lock and the parking lamps/tail lamps will flash once.

## Locks and Security

Press  again within three seconds to receive confirmation that the vehicle was successfully locked. **Note:** If all vehicle doors and the trunk are closed upon the second press of the , the horn will chirp once and the parking lamps/tail lamps will flash once to confirm the successful locking.

Upon the second press of the , if any door or the trunk is not securely closed the horn will chirp twice to warn that successfully locking was not complete. The parking lamps/tail lamps will **not** flash if any door is ajar.

### Car finder

Press  twice within three seconds. The horn will chirp and the park lamps/tail lamps will flash. It is recommended that this method be used to locate your vehicle, rather than using the panic alarm.

### Sounding a panic alarm

Press  on the remote transmitter to activate the alarm.

**Note:** The panic alarm only works with the ignition in the off position.

Press  a second time to deactivate the alarm. You may also deactivate the alarm by turning the ignition to the on position.

### Opening the trunk

Press  once to open the trunk.

- Ensure that the trunk is closed and latched before driving your vehicle. Failure to properly latch the trunk may cause objects to fall out or block the driver's rear view.

This feature will not work with a vehicle speed greater than 3 mph (5 km/h) if the ignition is in the accessory or on position.

### Replacing the battery

The remote entry transmitter uses one coin type three-volt lithium battery CR2032 or equivalent.

## Locks and Security

To replace the battery:

1. Twist a thin coin between the two halves of the remote entry transmitter near the key ring. **DO NOT TAKE THE RUBBER COVER AND CIRCUIT BOARD OFF THE FRONT HOUSING OF THE REMOTE ENTRY TRANSMITTER.**

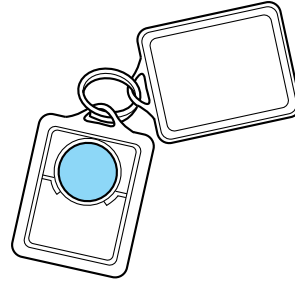

2. Do not wipe off any grease on the battery terminals on the back surface of the circuit board.

3. Remove the old battery.

**Note:** Please refer to local regulations when disposing of transmitter batteries.

4. Insert the new battery. Refer to the diagram inside the remote entry transmitter for the correct orientation of the battery. Press the battery down to ensure that the battery is fully seated in the battery housing cavity.

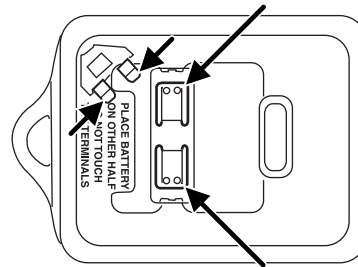

5. Snap the two halves back together.

**Note:** Replacement of the battery will **not** cause the remote transmitter to become deprogrammed from your vehicle. The remote transmitter should operate normally after battery replacement.

### Replacing lost transmitters

Take all your vehicle's transmitters to your authorized dealer if service is required.

If a remote transmitter has been lost and you would like to remove it from the vehicle's memory, or you would like to purchase additional remote transmitters and have them programmed to your vehicle:

- Take **all** your vehicle's transmitters to your authorized dealer for programming, or



## Locks and Security

- Perform the following programming procedure yourself:

**Note:** Ensure the brake pedal is not pressed during this sequence.

Place the key in the ignition and cycle from 1 (off) to 3 (on) eight times in rapid succession within 10 seconds. After doors lock/unlock, press any control on all transmitters (up to four). After pressing the control on each remote transmitter, the door will lock and unlock. If

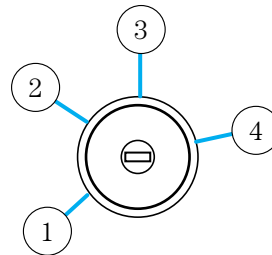

programming multiple remote transmitters, you must press the control buttons on each remote transmitter within seven seconds of each other to remain in programming mode. When completed, turn the ignition to 1 (off).

All transmitters **must** be programmed at the same time.

- When completed, turn the ignition to the 1 (on) position and wait at least 20 seconds in order to use the recently programmed transmitter(s).
- **All** transmitters **must** be programmed during the same programming cycle. A transmitter that is not programmed within the same programming cycle will be erased and will no longer operate your vehicle's locks. If this occurs, you will have to reprogram all the transmitters again, as you cannot just "add" a transmitter.

### Illuminated entry

The interior lamps illuminate when the remote entry system is used to unlock the door(s) or sound the personal alarm.

The illuminated entry system will turn off the interior lights if:

- the ignition switch is turned to the on or the accessory positions, or
- the remote transmitter lock control is pressed, or
- after 25 seconds of illumination.

The dome lamp control must **not** be set to the **off** position for the illuminated entry system to operate.

The inside lights will not turn off if:

- they have been turned on with the dimmer control, or
- any door is open.

The battery saver will shut off the interior lamps 30 minutes after the last door is closed, or after 10 minutes if the last door is left open.

## Locks and Security

### SECURICODE™ KEYLESS ENTRY SYSTEM (IF EQUIPPED)

With the keyless entry keypad, you can:

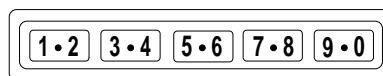

- lock or unlock the vehicle doors without using the key.
- open the trunk.

See also *Remote entry system* in this chapter for more information.

Your vehicle has a factory-set 5-digit code that operates the keyless entry system. You can also program your own 5-digit personal entry code.

The factory-set code is located:

- On the owner's wallet card in the glove compartment, or
- at your dealer.

When using the keyless entry keypad, press the middle of each button in order to ensure a good activation.

#### Programming a personal entry code

You can program up to three personal codes to unlock your vehicle. These codes do not replace the permanent code that the authorized dealer gave you.

To create your own personal entry code:

1. Enter the factory set code. **Note:** The keypad and the interior lamps will illuminate when pressed.
2. Within five seconds press 1 • 2 on the keypad to enter the programming mode.
3. Enter your personal 5-digit code. Each number must be entered within five seconds of each other.
4. Press 1 • 2 to store the first personal code.
5. The doors will lock then unlock to confirm programming of the new code.

To store a second personal code:

1. Enter the factory set code.
2. Within five seconds press 1 • 2 on the keypad to enter the programming mode.
3. Enter a second personal 5-digit code. Each number must be entered within five seconds of each other.

## Locks and Security

4. Press 3 • 4 to store the second personal code.
5. The doors will again lock then unlock to confirm programming of the new code.

To store a third personal code:

1. Enter the factory set code.
2. Within five seconds press 1 • 2 on the keypad to enter the programming mode.
3. Enter a third personal 5-digit code. Each number must be entered within five seconds of each other.
4. Press 5 • 6 (or 7 • 8, or 9 • 0, or wait five seconds) to store the third personal code.
5. The doors will again lock then unlock to confirm programming of the new code.

### **Tips:**

- Do not set a code that uses five of the same number.
- Do not use five numbers in sequential order.
- The factory set code will work even if you have set your own personal code.

### ***Erasing personal code***

To erase all of the personal entry codes programmed to a vehicle:

1. Enter the factory-set code.
2. Press and release 1 • 2 within five seconds of step 1.
3. Press and hold 1 • 2 for two seconds. All of the vehicle doors will lock and then unlock to confirm erasure.

### ***Unlocking the doors and releasing the trunk with the keyless entry system***

To unlock the driver door, enter either the factory-set code or personal code (each digit pressed within five seconds of prior digit). The interior lamps will illuminate.

- To **unlock all doors**, enter the factory-set code or personal code (driver door unlocks) and press 3 • 4 within five seconds.
- To **release the trunk**, enter the factory-set code or personal code (driver door unlocks) and press 5 • 6 within five seconds.

After the factory-set code or personal code has been entered, you can unlock all doors (press 3 • 4) and release the trunk (press 5 • 6) as long as the controls are pressed within five seconds of each other.

## Locks and Security

### **Locking doors with the keyless entry system**

It is not necessary to enter the factory-set code prior to locking all doors. To **lock the doors**, press 7 • 8 and press 9 • 0 at the same time.

**Note:** The doors will not lock if the driver door is ajar.

### **Anti-scan feature**

If the wrong code has been entered seven times (35 consecutive button presses), the keypad will go into an anti-scan mode. This mode disables the keypad for one minute and the keypad lamp will flash.

The anti-scan feature will turn off after:

- one minute of keypad inactivity.
- pressing the  control on the remote entry transmitter.
- the ignition is turned to the on position.

### **SECURILOCK® PASSIVE ANTI-THEFT SYSTEM**

SecuriLock® passive anti-theft system is an engine immobilization system. This system is designed to help prevent the engine from being started unless a **coded key programmed to your vehicle** is used. The use of the wrong type of coded key may lead to a “no-start” condition.

This device complies with part 15 of the FCC rules and with RSS-210 of Industry Canada. Operation is subject to the following two conditions: (1) This device may not cause harmful interference, and (2) This device must accept any interference received, including interference that may cause undesired operation.

### **Radio type approval numbers for Immobilizer System PATS XCVR**

If the type approval of your immobilizer system is inspected in one of the countries listed in the following table, refer to the corresponding approval number:

<b>Immobilizer System PATS XCVR certification numbers</b>	
<b>TX Frequency: 134,2 kHz</b>	<b>-8,1 dBµA/m @ 10 m</b>
<b>Country Name</b>	<b>Type Approval Number</b>
American Samoa (USA)	See USA
Bahrain	DLM/GEN/18/18/16
Barbados	340/3 Vol.II
Canada	CANADA: 3043104475A
China	CMII ID:2005DJ0428

## Locks and Security

Immobilizer System PATS XCVR certification numbers	
Ghana	SPLS / -485 / 2001
Guam (USA)	See USA
Jordan	4/U/U/4250
Kenya	CCK/ES/100/0
Kuwait	M.C/U.S.0 /5/7-12579
Mauritius	TA/2005/15
Mayotte (F)	<b>CE 0682 0</b>
Mexico	RLVVIVP03-324
Morocco	MR 1299 ANRT 2004
Netherlands Antilles (NL)	<b>CE 0682 0</b>
Nicaragua	NCG-CE-04-004
Northern Mariana Islands	See USA
Oman	OMA/1265(A) 1308/2001
Puerto Rico	See USA
Qatar	QTEL/SR/2003/R-276
Saudi Arabia	(10/1900)
South Korea	R-LPD1-04-0145
Tunisia	269/MAT/2004
United Arabian Emirates	5/10-2/3274/3774
Uruguay	025/FR/2003
USA	NT8-15607PAT3XCVR
Zambia	CAZ/ENG/CA/2005/02/8

**Changes or modifications not expressly approved by the party responsible for compliance could void the user's authority to operate the equipment.**

Your vehicle comes with **two coded keys**; additional coded keys may be purchased from your authorized dealer. The authorized dealer can program your spare keys to your vehicle or you can program the keys yourself. Refer to *Programming spare keys* for instructions on how to program the coded key.

**Note:** The SecuriLock® passive anti-theft system is not compatible with non-Ford aftermarket remote start systems. Use of these systems may result in vehicle starting problems and a loss of security protection.

## Locks and Security

**Note:** Large metallic objects, electronic devices that are used to purchase gasoline or similar items, or a second coded key on the same key chain may cause vehicle starting issues. You need to prevent these objects from touching the coded key while starting the engine. These objects will not cause damage to the coded key, but may cause a momentary issue if they are too close to the key when starting the engine. If a problem occurs, turn the ignition to the off position, remove all objects on the key chain away from the coded key and restart the engine.

**Note: Do not leave a duplicate coded key in the vehicle. Always take your keys and lock all doors when leaving the vehicle.**

### Anti-theft indicator

The anti-theft indicator is the flashing red indicator located on top of the dash panel to the left of the steering wheel.

- When the ignition is in the off position, the indicator will flash once every two seconds to indicate the SecuriLock® system is functioning as a theft deterrent.
- When the ignition is in the on position, the indicator will glow for three seconds to indicate normal system functionality.

If a problem occurs with the SecuriLock® system, the indicator will flash rapidly or glow steadily when the ignition is in the on position. If this occurs, contact your authorized dealer as soon as possible for service.

### Automatic arming

The vehicle is armed immediately after switching the ignition to the off position.

The theft indicator on the instrument panel will flash every two seconds when the vehicle is armed.

### Automatic disarming

Switching the ignition to the on position with a **coded key** disarms the vehicle.

- The theft indicator on the instrument panel will illuminate for three seconds and then go out.
- If the theft indicator stays on for an extended period of time or flashes rapidly, contact your authorized dealer as soon as possible.

## Locks and Security

### Replacement keys

If your keys are lost or stolen and you don't have an extra coded key, you will need to have your vehicle towed to an authorized dealer. The key codes need to be erased from your vehicle and new coded keys will need to be programmed.

Replacing coded keys can be very costly. Store an extra programmed key away from the vehicle in a safe place to help prevent any inconveniences. Please visit an authorized dealer to purchase additional spare or replacement keys.

### Programming spare keys

A maximum of eight keys can be coded to your vehicle. Only SecuriLock® keys can be used. To program a **coded key** yourself, you will need two previously programmed **coded keys** (keys that already operate your vehicle's engine) and the new unprogrammed key(s) readily accessible for timely implementation of each step in the procedure.

If two previously programmed coded keys are not available, you must bring your vehicle to your authorized dealer to have the spare coded key(s) programmed.

Please read and understand the entire procedure before you begin.

1. Insert the first previously programmed **coded key** into the ignition and turn the ignition from 1 (off) to the 3 (on) position (maintain ignition in 3 (on) for at least one second).

2. Turn ignition to 1 (off) and remove the first **coded key** from the ignition.

3. Within ten seconds of removing the first **coded key**, insert the second previously programmed **coded key** into the ignition and turn the ignition from 1 (off) to the 3 (on) position (maintain ignition in 3 (on) for at least one second but no more than ten seconds).

4. Turn the ignition to 1 (off) and remove the second **coded key** from the ignition.

5. Within twenty seconds of removing the second **coded key**, insert the new unprogrammed key (new key) into the ignition and turn the ignition from 1 (off) to the 3 (on) position (maintain ignition in 3 (on) for at least one second). This step will program your new key.

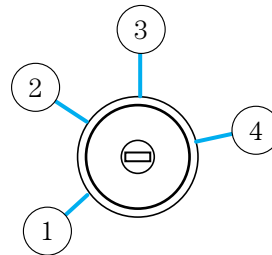

## Locks and Security

6. To program additional new unprogrammed key(s), wait at least 20 seconds and repeat this procedure from Step 1.

If successful, the new coded key(s) will start the vehicle's engine and the theft indicator will illuminate for three seconds and then go out.

If not successful, the new coded key(s) will not start the vehicle's engine and the theft indicator will flash on and off. You may repeat Steps 1 through 6. If failure repeats, bring your vehicle to your authorized dealer to have the new spare key(s) programmed.



## Seating and Safety Restraints

### SEATING

#### Adjustable head restraints

Your vehicle is equipped with front row outboard head restraints that are vertically adjustable.

**WARNING:** To minimize the risk of neck injury in the event of a crash, the driver and passenger occupants should not sit in and/or operate the vehicle, until the head restraint is placed in its proper position. The driver should never adjust the head restraint while the vehicle is in motion.

The adjustable head restraints consist of:

- a trimmed energy absorbing foam and structure (1),
- two steel stems (2),
- a guide sleeve adjust/release button (3),
- and a guide sleeve unlock/remove button (4).

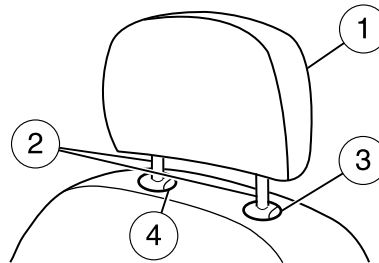

To adjust the head restraint, do the following:

1. Adjust the seatback to an upright driving/riding position.
2. Raise the head restraint by pulling up on the head restraint.

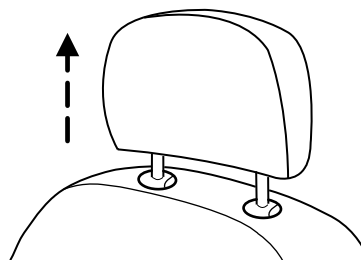

## Seating and Safety Restraints

3. Lower the head restraint by pressing and holding the guide sleeve adjust/release button and pushing down on the head restraint.

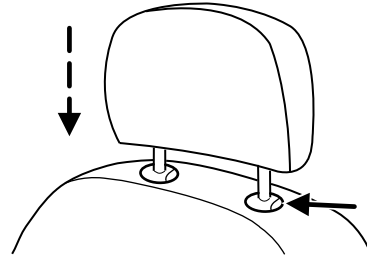

Properly adjust the head restraint so that the top of the head restraint is even with the top of your head and positioned as close as possible to the back of your head. For occupants of extremely tall stature, adjust the head restraint to its full up position.



**WARNING:** The adjustable head restraint is a safety device. Whenever possible it should be installed and properly adjusted when the seat is occupied.

To remove the adjustable head restraint, do the following:

1. Pull up the head restraint until it reaches the highest adjustment position.

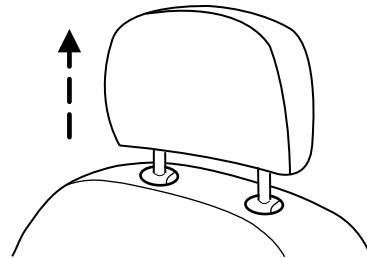

## Seating and Safety Restraints

2. Simultaneously press and hold both the adjust/release button and the unlock/remove button, then pull up on the head restraint.

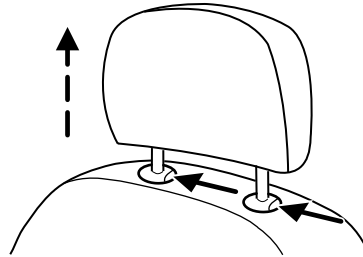

To reinstall the adjustable head restraint, do the following:

1. Insert the two stems into the guide sleeve collars.
2. Push the head restraint down until it locks.

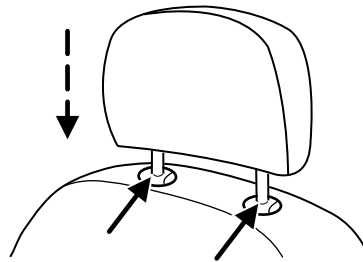

Properly adjust the head restraint so that the top of the head restraint is even with the top of your head and positioned as close as possible to the back of your head. For occupants of extremely tall stature, adjust the head restraint to its full up position.



**WARNING:** To minimize the risk of neck injury in the event of a crash, head restraints must be installed properly.

### Adjusting the front manual seat (if equipped)



**WARNING:** Never adjust the driver's seat or seatback when the vehicle is moving.



**WARNING:** Always drive and ride with your seatback upright and the lap belt snug and low across the hips.

## Seating and Safety Restraints

Lift handle to move seat forward or backward.

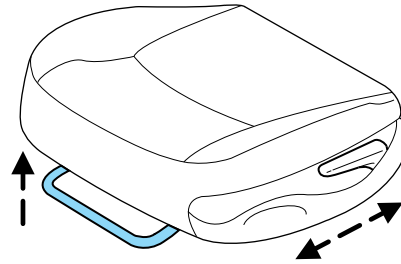

Pull lever up to adjust seatback.

**!** **WARNING:** Before returning the seatback to its original position, make sure that cargo or any objects are not trapped behind the seatback. After returning the seatback to its original position, pull on the seatback to ensure that it has fully latched. An unlatched seat may become dangerous in the event of a sudden stop or collision.

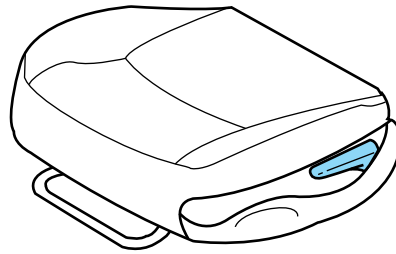

### **Using the manual recline function (if equipped)**

**!** **WARNING:** Never adjust the driver's seat or seatback when the vehicle is moving.

**!** **WARNING:** Do not pile cargo higher than the seatbacks to avoid injuring people in a collision or sudden stop.

**!** **WARNING:** Always drive and ride with your seatback upright and the lap belt snug and low across the hips.

**!** **WARNING:** Reclining the seatback can cause an occupant to slide under the seat's safety belt, resulting in severe personal injuries in the event of a collision.

## Seating and Safety Restraints

To adjust the front seatback using the manual recliner:

- Lift and hold the handle located on the side of the seat.
- Lean against the seatback to adjust it to your desired position. You can recline the seat back or bring it forward.
- Release the handle when the desired position has been reached.

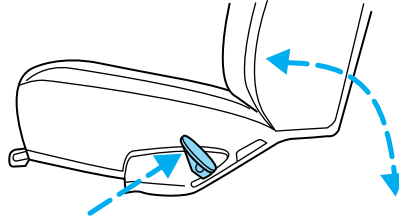

### Adjusting the power front seats (if equipped)

The controls for the power seats are located on the inside of each front door.



**WARNING:** Never adjust the driver's seat or seatback when the vehicle is moving.



**WARNING:** Do not pile cargo higher than the seatbacks to avoid injuring people in a collision or sudden stop.



**WARNING:** Always drive and ride with your seatback upright and the lap belt snug and low across the hips.



**WARNING:** Reclining the seatback can cause an occupant to slide under the seat's safety belt, resulting in severe personal injuries in the event of a collision.



**WARNING:** Sitting improperly out of position or with the seat back reclined too far can take off weight from the seat cushion and affect the decision of the passenger sensing system, resulting in serious injury or death in a crash. Always sit upright against your seatback, with your feet on the floor.

## Seating and Safety Restraints

**⚠ WARNING:** To reduce the risk of possible serious injury: Do not hang objects off seat back or stow objects in the seatback map pocket (if equipped) when a child is in the front passenger seat. Do not place objects underneath the front passenger seat or between the seat and the center console (if equipped). Check the “passenger airbag off” or “pass airbag off” indicator lamp for proper airbag status. Refer to *Front passenger sensing system* in the *Airbag supplemental restraint system (SRS)* section for additional details. Failure to follow these instructions may interfere with the front passenger seat sensing system.

Press the control to recline the seatback forward or backward.

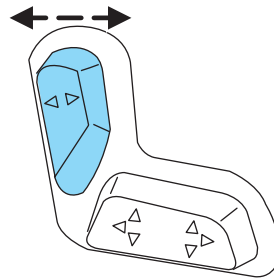

Press to move the seat forward or backward.

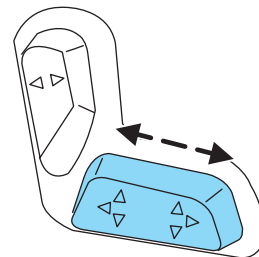

## Seating and Safety Restraints

Press to move the front portion of the seat cushion up or down.

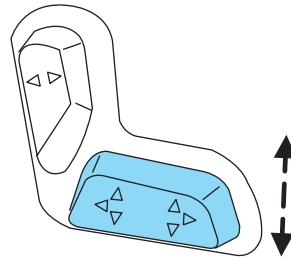

Press to move the rear portion of the seat cushion up or down.

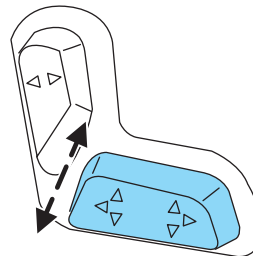

### Using the power lumbar support (if equipped)

The power lumbar control is located on the front inboard side of the seat.

Press the top side of the control to adjust firmness.

Press the bottom side of the control to adjust softness.

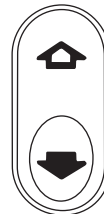

## Seating and Safety Restraints

### Heated seats (if equipped)

 **WARNING:** Persons who are unable to feel pain to the skin because of advanced age, chronic illness, diabetes, spinal cord injury, medication, alcohol use, exhaustion, or other physical conditions, must exercise care when using the seat heater. The seat heater may cause burns even at low temperatures, especially if used for long periods of time. Do not place anything on the seat that insulates against heat, such as a blanket or cushion, because this may cause the seat heater to overheat. Do not puncture the seat with pins, needles, or other pointed objects because this may damage the heating element which may cause the seat heater to overheat. An overheated seat may cause serious personal injury.

**Note:** Do not do the following:

- Place heavy objects on the seat
- Operate the seat heater if water or any other liquid is spilled on the seat. Allow the seat to dry thoroughly.

The heated seat control is located on the driver's or front passenger's door.

To operate the heated seats:

- Press the indicated side of the control for maximum heat.
- Press again to deactivate.



- Press the indicated side of the control for minimum heat.
- Press again to deactivate.

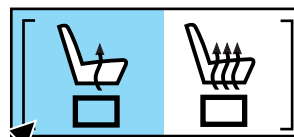

The heated seat module resets at every ignition run cycle. While the ignition is in the on position, activating the high or low heated seat switch enables heating mode. When activated, they will turn off automatically when the ignition is turned to the off position.



## Seating and Safety Restraints

The indicator light will illuminate when the heated seats have been activated.

### REAR SEATS

#### Seat-mounted cup holders and armrest storage compartment (if equipped)

To access the cup holders, fold the armrest down.

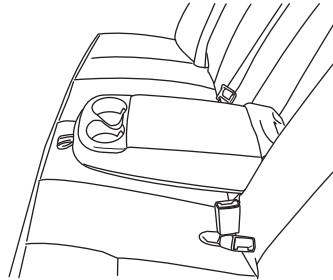

**WARNING:** Use only soft cups in the cup holder. Hard objects can injure you in a collision.

### SAFETY RESTRAINTS

#### Personal Safety System™

The Personal Safety System provides an improved overall level of frontal crash protection to front seat occupants and is designed to help further reduce the risk of airbag-related injuries. The system is able to analyze different occupant conditions and crash severity before activating the appropriate safety devices to help better protect a range of occupants in a variety of frontal crash situations.

Your vehicle's Personal Safety System consists of the following items:

- Driver and passenger dual-stage airbag supplemental restraints
- Front safety belts with pretensioners, energy management retractors, and safety belt usage sensors
- Driver's seat position sensor
- Front crash severity sensor
- Front passenger sensing system
- "Passenger airbag off" or "pass airbag off" indicator lamp

<https://www.MyCarManual.com>

## Seating and Safety Restraints

- Restraints Control Module (RCM) with impact and safing sensors
- Restraint system warning light and back-up tone
- The electrical wiring for the airbags, crash sensor(s), safety belt pretensioners, front safety belt usage sensors, driver seat position sensor, front passenger sensing system, and indicator lights.

### ***How does the Personal Safety System™ work?***

The Personal Safety System can adapt the deployment strategy of your vehicle's safety devices according to crash severity and occupant conditions. A collection of crash and occupant sensors provides information to the Restraints control module (RCM). During a crash, the RCM may activate the safety belt pretensioners and/or either one or both stages of the dual-stage airbag supplemental restraints based on crash severity and occupant conditions.

The fact that the pretensioners or airbags did not activate for both front seat occupants in a collision does not mean that something is wrong with the system. Rather, it means the Personal Safety System determined the accident conditions (crash severity, belt usage, etc.) were not appropriate to activate these safety devices. Front airbags are designed to activate only in frontal and near-frontal collisions, not rollovers, side-impacts, or rear-impacts unless the collision causes sufficient longitudinal deceleration.

### ***Driver and passenger dual-stage airbag supplemental restraints***

The dual-stage airbags offer the capability to tailor the level of airbag inflation energy. A lower, less forceful energy level is provided for more common, moderate-severity impacts. A higher energy level is used for the most severe impacts. Refer to *Airbag supplemental restraints (SRS)* section in this chapter.

### ***Front crash severity sensor***

The front crash severity sensor enhances the ability to detect the severity of an impact. Positioned up front, it provides valuable information early in the crash event on the severity of the impact. This allows your Personal Safety System to distinguish between different levels of crash severity and modify the deployment strategy of the dual-stage airbags and safety belt pretensioners.

### ***Driver's seat position sensor***

The driver's seat position sensor allows your Personal Safety System to tailor the deployment level of the driver dual-stage airbag based on seat position. The system is designed to help protect smaller drivers sitting close to the driver airbag by providing a lower airbag output level.

## Seating and Safety Restraints

### **Front passenger sensing system**

For airbags to do their job they must inflate with great force, and this force can pose a potentially deadly risk to occupants that are very close to the airbag when it begins to inflate. For some occupants, like infants in rear-facing child seats, this occurs because they are initially sitting very close to the airbag. For other occupants, this occurs when the occupant is not properly restrained by safety belts or child safety seats and they move forward during pre-crash braking. The most effective way to reduce the risk of unnecessary injuries is to make sure all occupants are properly restrained. Accident statistics suggest that children are much safer when properly restrained in the rear seating positions than in the front.



**WARNING:** Air bags can kill or injure a child in a child seat. **NEVER** place a rear-facing child seat in front of an active air bag. If you must use a forward-facing child seat in the front seat, move the seat all the way back.



**WARNING:** When possible, all children 12 years old and under should be properly restrained in a rear seating position.

The front passenger sensing system can automatically turn off the front passenger airbag and passenger seat-mounted side airbag. The system is designed to help protect small (child size) occupants from frontal airbag deployments when they are seated or restrained in the front passenger seat contrary to proper child-seating or restraint usage recommendations. Even with this technology, parents are **STRONGLY** encouraged to always properly restrain children in the rear seat. The sensor also turns off the passenger front airbag when the passenger seat is empty. The sensor turns off the passenger seat-mounted side airbag when the seat is empty and the safety belt is unbuckled or buckled.

When the front passenger seat is occupied and the sensing system has turned off the passenger's frontal airbag, the "pass airbag off" indicator will light and stay lit to remind you that the front passenger frontal airbag is off. See *Front passenger sensing system* in the *Airbag supplemental restraints (SRS)* section of this chapter.

### **Front safety belt usage sensors**

The front safety belt usage sensors detect whether or not the driver and front outboard passenger safety belts are fastened. This information allows your Personal Safety System to tailor the airbag deployment and safety belt pretensioner activation depending upon safety belt usage.

## Seating and Safety Restraints

### **Front safety belt pretensioners**

The safety belt pretensioners at the front outboard seating positions are designed to tighten the safety belts firmly against the occupant's body during frontal collisions and in side collisions. This helps increase the effectiveness of the safety belts. In frontal collisions, the safety belt pretensioners can be activated alone or, if the collision is of sufficient severity, together with the front airbags.

### **Front safety belt energy management retractors**

The front outboard safety belt energy management retractors allow webbing to be pulled out of the retractor in a gradual and controlled manner in response to the occupant's forward momentum. This helps reduce the risk of force-related injuries to the occupant's chest by limiting the load on the occupant. Refer to *Energy management feature* section in this chapter.

### **Determining if the Personal Safety System is operational**

The Personal Safety System uses a warning light in the instrument cluster or a back-up tone to indicate the condition of the system. Refer to the *Warning light and chimes* section in the *Instrument Cluster* chapter. Routine maintenance of the Personal Safety System is not required.

The restraints control module (RCM) monitors its own internal circuits and the circuits for the airbag supplemental restraints, crash sensor(s), safety belt pretensioners, front safety belt buckle sensors, front passenger sensing system, and the driver seat position sensor. In addition, the RCM also monitors the restraints warning light in the instrument cluster. A difficulty with the system is indicated by one or more of the following.

- The warning light will either flash or stay lit.
- The warning light will not illuminate immediately after ignition is turned on.
- A series of five beeps will be heard. The tone pattern will repeat periodically until the problem and warning light are repaired.

If any of these things happen, even intermittently, have the Personal Safety System serviced at an authorized dealer immediately. Unless serviced, the system may not function properly in the event of a collision.

## Seating and Safety Restraints

### Safety restraints precautions



**WARNING:** Always drive and ride with your seatback upright and the lap belt snug and low across the hips.



**WARNING:** To reduce the risk of injury, make sure children sit in a rear seating position where they can be properly restrained.



**WARNING:** Never let a passenger hold a child on his or her lap while the vehicle is moving. The passenger cannot protect the child from injury in a collision.



**WARNING:** All occupants of the vehicle, including the driver, should always properly wear their safety belts, even when an airbag supplemental restraint system (SRS) is provided.



**WARNING:** It is extremely dangerous to ride in a cargo area, inside or outside of a vehicle. In a collision, people riding in these areas are more likely to be seriously injured or killed. Do not allow people to ride in any area of your vehicle that is not equipped with seats and safety belts. Be sure everyone in your vehicle is in a seat and using a safety belt properly.



**WARNING:** In a rollover crash, an unbelted person is significantly more likely to die than a person wearing a safety belt.





**WARNING:** Each seating position in your vehicle has a specific safety belt assembly which is made up of one buckle and one tongue that are designed to be used as a pair. 1) Use the shoulder belt on the outside shoulder only. Never wear the shoulder belt under the arm. 2) Never swing the safety belt around your neck over the inside shoulder. 3) Never use a single belt for more than one person.



**WARNING:** When possible, all children 12 years old and under should be properly restrained in a rear seating position.

## Seating and Safety Restraints

 **WARNING:** Safety belts and seats can become hot in a vehicle that has been closed up in sunny weather; they could burn a small child. Check seat covers and buckles before you place a child anywhere near them.

 **WARNING:** Front and rear seat occupants, including pregnant women, should wear safety belts for optimum protection in an accident.

### Combination lap and shoulder belts

1. Insert the belt tongue into the proper buckle (the buckle closest to the direction the tongue is coming from) until you hear a snap and feel it latch. Make sure the tongue is securely fastened in the buckle.

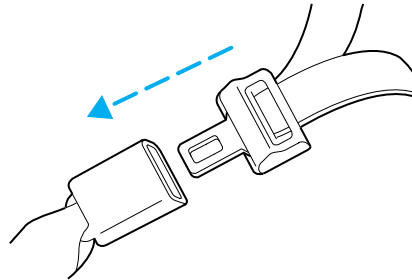

2. To unfasten, press the release button and remove the tongue from the buckle.

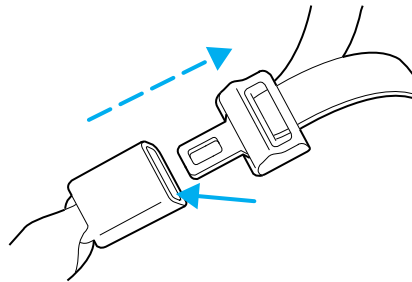

## Seating and Safety Restraints

### **Restraint of pregnant women**

 **WARNING:** Always ride and drive with your seatback upright and the safety belt properly fastened. The lap portion of the safety belt should fit snug and be positioned low across the hips. The shoulder portion of the safety belt should be positioned across the chest. Pregnant women should also follow this practice. See figure below.

Pregnant women should always wear their safety belt. The lap belt portion of a combination lap and shoulder belt should be positioned low across the hips below the belly and worn as tight as comfort will allow. The shoulder belt should be positioned to cross the middle of the shoulder and the center of the chest.

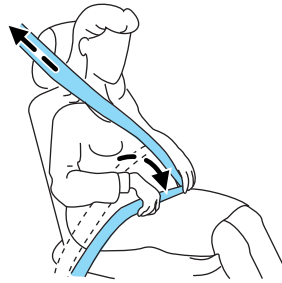

### **Lap belts**

#### **Adjusting the front center seat lap belt (if equipped)**

 **WARNING:** The lap belt should fit snugly and as low as possible around the hips, not across the waist.

The lap belt does not adjust automatically. Insert the tongue into the correct buckle (the buckle closest to the direction the tongue is coming from). To lengthen the belt, turn the tongue at a right angle to the belt and pull across your lap until it reaches the buckle. To tighten the belt, pull the loose end of the belt through the tongue until it fits snugly across the hips.

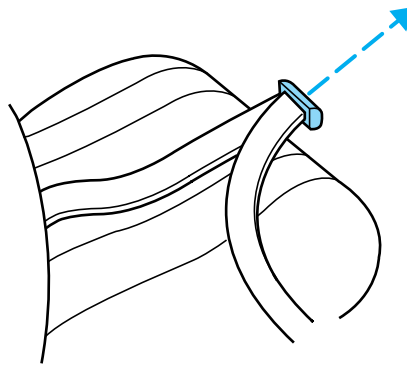

## Seating and Safety Restraints

Shorten and fasten the belt when not in use.

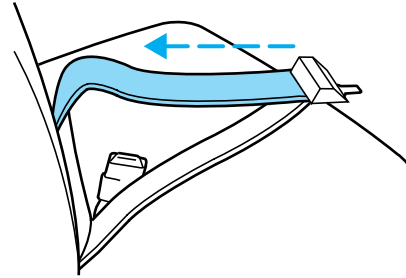

### Safety belt locking modes

The front outboard and rear safety restraints in the vehicle are combination lap and shoulder belts. The driver safety belt has the first locking mode and the front outboard passenger and rear seat safety belts have both types of locking modes described as follows:

#### Vehicle sensitive mode

This is the normal retractor mode, which allows free shoulder belt length adjustment to your movements and locking in response to vehicle movement. For example, if the driver brakes suddenly or turns a corner sharply, or the vehicle receives an impact of approximately 5 mph (8 km/h) or more, the combination safety belts will lock to help reduce forward movement of the driver and passengers.

In addition, the retractor is designed to lock if the webbing is pulled out too quickly. If this occurs, let the belt retract slightly and pull webbing out again in a slow and controlled manner.

#### Automatic locking mode

In this mode, the shoulder belt is automatically pre-locked. The belt will still retract to remove any slack in the shoulder belt. The automatic locking mode is not available on the driver safety belt.

#### When to use the automatic locking mode

This mode should be used **any time** a child safety seat, except a booster, is installed in passenger front or rear seating positions. Children 12 years old and under should be properly restrained in a rear seating position whenever possible. Refer to *Safety restraints for children* or *Safety seats for children* later in this chapter.



## Seating and Safety Restraints

### ***How to use the automatic locking mode***

1. Buckle the combination lap and shoulder belt.
2. Grasp the shoulder portion and pull downward until the entire belt is pulled out.

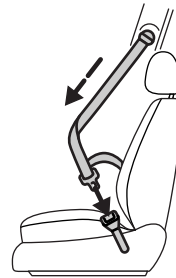

3. Allow the belt to retract. As the belt retracts, you will hear a clicking sound. This indicates the safety belt is now in the automatic locking mode.

### **How to disengage the automatic locking mode**

Disconnect the combination lap/shoulder belt and allow it to retract completely to disengage the automatic locking mode and activate the vehicle sensitive (emergency) locking mode.



**WARNING:** After any vehicle collision, the safety belt system at all passenger seating positions must be checked by an authorized dealer to verify that the “automatic locking retractor” feature for child seats is still functioning properly. In addition, all safety belts should be checked for proper function.



**WARNING:** BELT AND RETRACTOR ASSEMBLY MUST BE REPLACED if the safety belt assembly “automatic locking retractor” feature or any other safety belt function is not operating properly when checked by an authorized dealer. Failure to replace the belt and retractor assembly could increase the risk of injury in collisions.

### **Energy management feature**

- This vehicle has a safety belt system with an energy management feature at the front outboard seating positions to help further reduce the risk of injury in the event of a head-on collision.
- The energy management feature is designed to pay out webbing in a controlled manner. This feature is designed to help reduce the belt force acting on the occupant’s chest.

## Seating and Safety Restraints

### Safety belt extension assembly

If the safety belt is too short when fully extended, there is an 8 inch (20 cm) safety belt extension assembly that can be added (part number 611C22). This assembly can be obtained from an authorized dealer.

Use only extensions manufactured by the same supplier as the safety belt. Manufacturer identification is located at the end of the webbing on the label. Also, use the safety belt extension only if the safety belt is too short for you when fully extended.



**WARNING:** Do not use extensions to change the fit of the shoulder belt across the torso.

### Front safety belt height adjustment

Your vehicle has safety belt height adjustments for the driver and front outboard passenger. Adjust the height of the shoulder belt so the belt rests across the middle of your shoulder.

To lower the shoulder belt height, press the button and slide the height adjuster down. To raise the height of the shoulder belt, press the button and slide the height adjuster up. Pull down on the height adjuster to make sure it is locked in place.

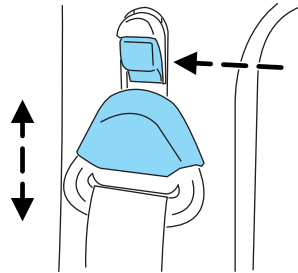

**WARNING:** Position the safety belt height adjusters so that the belt rests across the middle of your shoulder. Failure to adjust the safety belt properly could reduce the effectiveness of the seat belt and increase the risk of injury in a collision.

### Safety belt warning light and indicator chime

The safety belt warning light illuminates in the instrument cluster and a chime sounds to remind the occupants to fasten their safety belts.

## Seating and Safety Restraints

### Conditions of operation

If...	Then...
The driver's safety belt is not buckled before the ignition switch is turned to the on position...	The safety belt warning light illuminates 1-2 minutes and the warning chime sounds 4-8 seconds.
The driver's safety belt is buckled while the indicator light is illuminated and the warning chime is sounding...	The safety belt warning light and warning chime turn off.
The driver's safety belt is buckled before the ignition switch is turned to the on position...	The safety belt warning light and indicator chime remain off.

### Belt-Minder®

The Belt-Minder® feature is a supplemental warning to the safety belt warning function. This feature provides additional reminders by intermittently sounding a chime and illuminating the safety belt warning light in the instrument cluster when the driver's and front passenger's safety belt is unbuckled.

The Belt-Minder® feature uses information from the front passenger sensing system to determine if a front seat passenger is present and therefore potentially in need of a warning. To avoid activating the Belt-Minder® feature for objects placed in the front passenger seat, warnings will only be given to large front seat occupants as determined by the front passenger sensing system.

Both the driver's and passenger's safety belt usages are monitored and either may activate the Belt-Minder® feature. The warnings are the same for the driver and the front passenger. If the Belt-Minder® warnings have expired (warnings for approximately five minutes) for one occupant (driver or front passenger), the other occupant can still activate the Belt-Minder® feature.

## Seating and Safety Restraints

If...	Then...
The driver's and front passenger's safety belts are buckled before the ignition switch is turned to the on position or less than 1-2 minutes have elapsed since the ignition switch has been turned to on...	The Belt-Minder® feature will not activate.
The driver's or front passenger's safety belt is not buckled when the vehicle has reached at least 3 mph (5 km/h) and 1-2 minutes have elapsed since the ignition switch has been turned to on...	The Belt-Minder® feature is activated - the safety belt warning light illuminates and the warning chime sounds for six seconds every 30 seconds, repeating for approximately five minutes or until the safety belts are buckled.
The driver's or front passenger's safety belt becomes unbuckled for approximately one minute while the vehicle is traveling at least 3 mph (5 km/h) and more than 1-2 minutes have elapsed since the ignition switch has been turned to on...	The Belt-Minder® feature is activated - the safety belt warning light illuminates and the warning chime sounds for six seconds every 30 seconds, repeating for approximately five minutes or until the safety belts are buckled.

## Seating and Safety Restraints

The following are reasons most often given for not wearing safety belts  
(All statistics based on U.S. data):

Reasons given...	Consider...
“Crashes are rare events”	<b>36700 crashes occur every day.</b> The more we drive, the more we are exposed to “rare” events, even for good drivers. <i>1 in 4 of us will be seriously injured in a crash during our lifetime.</i>
“I’m not going far”	<b>3 of 4</b> fatal crashes occur within <b>25</b> miles (40 km) of home.
“Belts are uncomfortable”	We design our safety belts to enhance comfort. If you are uncomfortable - try different positions for the safety belt upper anchorage and seatback which should be as upright as possible; this can improve comfort.
“I was in a hurry”	<b>Prime time for an accident.</b> Belt-Minder® reminds us to take a few seconds to buckle up.
“Safety belts don’t work”	<b>Safety belts</b> , when used properly, <b>reduce risk of death</b> to front seat occupants by <b>45% in cars</b> , and by <b>60% in light trucks</b> .
“Traffic is light”	<b>Nearly 1 of 2 deaths occur in single-vehicle crashes</b> , many when no other vehicles are around.
“Belts wrinkle my clothes”	Possibly, but a serious crash can do much more than wrinkle your clothes, particularly if you are unbelted.
“The people I’m with don’t wear belts”	Set the example, teen deaths occur 4 times more often in vehicles with TWO or MORE people. Children and younger brothers/sisters imitate behavior they see.

## Seating and Safety Restraints

Reasons given...	Consider..
“I have an airbag”	Airbags offer greater protection when used with safety belts. Frontal airbags are not designed to inflate in rear and side crashes or rollovers.
“I’d rather be thrown clear”	Not a good idea. <b>People</b> who are <b>ejected are 40 times more likely to DIE</b> . Safety belts help prevent ejection, WE CAN’T “PICK OUR CRASH”.



**WARNING:** Do not sit on top of a buckled safety belt or insert a latchplate into the buckle to avoid the Belt-Minder® chime. To do so may adversely affect the performance of the vehicle’s airbag system.

### **One-time disable**

If at any time the driver/front passenger quickly buckles then unbuckles the safety belt for that seating position, the Belt-Minder® is disabled for the current ignition cycle. The Belt-Minder® feature will enable during the same ignition cycle if the occupant buckles and remains buckled for approximately 30 seconds. Confirmation is not given for the one-time disable.

### **Deactivating/activating the Belt-Minder® feature**

**The driver and front passenger Belt-Minder® are deactivated/activated independently. When deactivating/activating one seating position, do not buckle the other position as this will terminate the process.**

*Read Steps 1 - 4 thoroughly before proceeding with the deactivation/activation programming procedure.*

**Note:** The driver and front passenger Belt-Minder® features must be disabled/enabled separately. Both cannot be disabled/enabled during the same key cycle.

## Seating and Safety Restraints

The driver and front passenger Belt-Minder® features can be deactivated/activated by performing the following procedure:

Before following the procedure, make sure that:

- The parking brake is set.
- The gearshift is in P (Park).
- The ignition switch is in the off position.
- The driver and front passenger safety belts are unbuckled.



**WARNING:** While the design allows you to deactivate your Belt-Minder®, this system is designed to improve your chances of being safely belted and surviving an accident. We recommend you leave the Belt-Minder® system activated for yourself and others who may use the vehicle. To reduce the risk of injury, do not deactivate/activate the Belt-Minder® feature while driving the vehicle.

1. Turn the ignition switch to the on position. **DO NOT START THE ENGINE.**
2. Wait until the safety belt warning light turns off (Approximately one minute).
  - Step 3 must be completed within 50 seconds after the safety belt warning light turns off.
3. For the seating position being disabled, buckle then unbuckle the safety belt nine times at a moderate speed, ending in the unbuckled state. Step 3 must be completed within 50 seconds after the safety belt warning light turns off.
  - After Step 3, the restraint system warning light (airbag light) will be turned on for three seconds.
4. Within approximately seven seconds of the light turning off, buckle then unbuckle the safety belt.
  - This will disable the Belt-Minder® feature for that seating position if it is currently enabled. As confirmation, the restraint system warning light will flash four times per second for three seconds.
  - This will enable the Belt-Minder® feature for that seating position if it is currently disabled. As confirmation, the restraint system warning light will flash four times per second for three seconds, followed by three seconds with the light off, then followed by the restraint system warning light flashing four times per second for three seconds again.

## Seating and Safety Restraints

### AIRBAG SUPPLEMENTAL RESTRAINT SYSTEM (SRS)

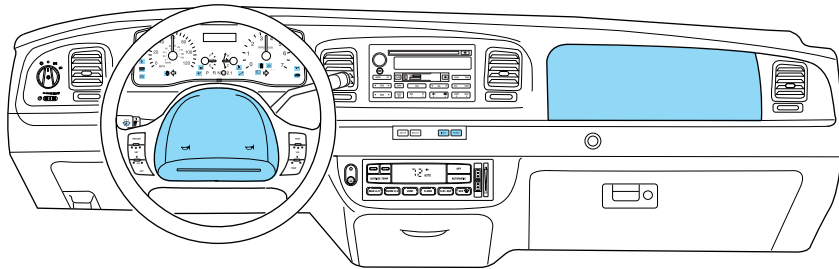

#### Important SRS precautions

The SRS is designed to work with the safety belt to help protect the driver and right front passenger from certain upper body injuries. Airbags DO NOT inflate slowly; there is a risk of injury from a deploying airbag.

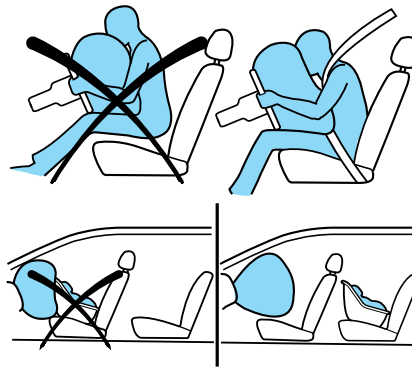

**WARNING:** All occupants of the vehicle, including the driver, should always properly wear their safety belts, even when an air bag supplemental restraint system (SRS) is provided.

**WARNING:** When possible, all children 12 years old and under should be properly restrained in a rear seating position.

**WARNING:** The National Highway Traffic Safety Administration (NHTSA) recommends a minimum distance of at least 10 inches (25 cm) between an occupant's chest and the driver airbag module.



## Seating and Safety Restraints



**WARNING:** Never place your arm over the air bag module as a deploying air bag can result in serious arm fractures or other injuries.



**WARNING:** Ford Motor Company recommends that an authorized dealer inspect all steering column assemblies in use in vehicles involved in a collision. Failure to inspect and if necessary replace the steering column assembly could result in severe injury or death in the event of a collision.



**WARNING:** Do not attempt to service, repair, or modify the steering column, its adaptive module, or its fuses. See your authorized dealer.

To properly position yourself away from the airbag:

- Move your seat to the rear as far as you can while still reaching the pedals comfortably.
- Recline the seat slightly one or two degrees from the upright position.



**WARNING:** Do not put anything on or over the air bag module. Placing objects on or over the air bag inflation area may cause those objects to be propelled by the air bag into your face and torso causing serious injury.



**WARNING:** Do not attempt to service, repair, or modify the airbag supplemental restraint systems or its fuses. See your authorized dealer.



**WARNING:** The front passenger airbag is not designed to offer protection to an occupant in the center front seating position.





**WARNING:** Modifying or adding equipment to the front end of the vehicle (including frame, bumper, front end body structure and tow hooks) may affect the performance of the airbag system, increasing the risk of injury. Do not modify the front end of the vehicle.

## Seating and Safety Restraints

### Children and airbags

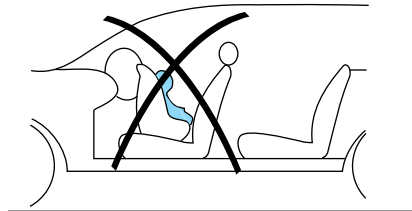
Children must always be properly restrained. Accident statistics suggest that children are safer when properly restrained in the rear seating positions than in the front seating position. Failure to follow these instructions may increase the risk of injury in a collision.



 **WARNING:** Airbags can kill or injure a child in a child seat. **NEVER** place a rear-facing child seat in front of an active airbag. If you must use a forward-facing child seat in the front seat, move the seat all the way back.

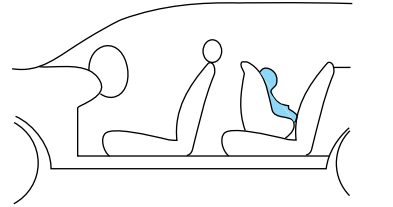

 **WARNING:** Front seating positions only: If seating two adults and a child, Ford recommends properly restraining the child in the center front seating position, but only if doing so will not interfere with driving the vehicle. This arrangement provides lap and shoulder belt and airbag protection for adult occupants and an attachment method for a child restraint. If the child seat interferes with driving the vehicle and the child restraint is forward-facing, the child may be restrained in the passenger seat. Move the seat as far rearward as possible to minimize the likelihood of interaction with the front passenger airbag. Never place a rear-facing child seat in front of an active airbag. All occupants of the vehicle should always properly wear their safety belts. Ensure the child is properly restrained in an appropriate child seat or with the use of a booster.

## Seating and Safety Restraints

### How does the airbag supplemental restraint system work?

The airbag SRS is designed to activate when the vehicle sustains longitudinal deceleration sufficient to cause the sensors to close an electrical circuit that initiates airbag inflation.

The fact that the airbags did not inflate in a collision does not mean that something is wrong with the system. Rather, it means the forces were not of the type sufficient to cause activation. Driver and passenger airbags are designed to inflate in

frontal and near-frontal collisions, not rollover, side-impact, or rear-impacts unless the collision causes sufficient longitudinal deceleration.

The airbags inflate and deflate rapidly upon activation. After airbag deployment, it is normal to notice a smoke-like, powdery residue or smell the burnt propellant. This may consist of cornstarch, talcum powder (to lubricate the bag) or sodium compounds (e.g., baking soda) that result from the combustion process that inflates the airbag. Small amounts of sodium hydroxide may be present which may irritate the skin and eyes, but none of the residue is toxic.

While the system is designed to help reduce serious injuries, contact with a deploying airbag may also cause abrasions, swelling or temporary hearing loss. Because airbags must inflate rapidly and with considerable force, there is the risk of death or serious injuries such as fractures, facial and eye injuries or internal injuries, particularly to occupants who are not properly restrained or are otherwise out of position at the time of airbag deployment. Thus, it is extremely important that occupants be properly restrained as far away from the airbag module as possible while maintaining vehicle control.

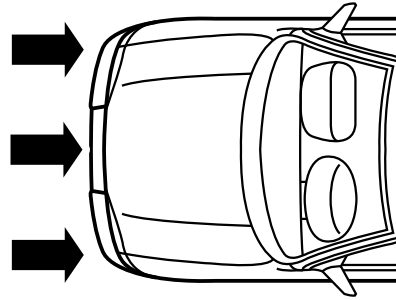

## Seating and Safety Restraints

The SRS consists of the following items:

- Driver and passenger airbag modules (which include the inflators and airbags)
- safety belt pretensioners
- Front passenger sensing system
- “Passenger airbag off” or “pass airbag off” indicator lamp. Refer to *Front passenger sensing system* later in this chapter.
- Driver and passenger side airbags
- Seat-mounted side airbag system.
- One or more impact and safing sensors
- A readiness light and tone
- A diagnostic module
- The electrical wiring which connects the components

The diagnostic module monitors its own internal circuits as well as the supplemental airbag electrical system wiring (including the impact sensors), the system wiring, the airbag system readiness light, the airbag backup power and the airbag ignitors.



**WARNING:** Several air bag system components get hot after inflation. Do not touch them after inflation.



**WARNING:** If the air bag has deployed, **the air bag will not function again and must be replaced immediately.** If the air bag is not replaced, the unrepaired area will increase the risk of injury in a collision.



**WARNING:** If the safety belt pretensioners deploy in an accident, they will not function again (belt will not extract or retract) and must be replaced immediately. Failure to replace the retractor assemblies will increase the risk of injury.

### Front passenger sensing system

The front passenger sensing system is designed to meet the regulatory requirements of Federal Motor Vehicle Safety Standard (FMVSS) 208 and is designed to disable (will not inflate) the front passenger's frontal airbag under certain conditions.

## Seating and Safety Restraints

The front passenger sensing system works with sensors that are part of the front passenger's seat and safety belt. The sensors are designed to detect the presence of a properly seated occupant and determine if the front passenger's frontal airbag should be enabled (may inflate) or disabled (will not inflate).

The front passenger sensing system will disable (will not inflate) the front passenger's frontal airbag if:

- the front passenger seat is unoccupied, or has small/medium objects in the front seat,
- the system determines that an infant is present in a rear-facing infant seat that is installed according to the manufacturer's instructions,
- the system determines that a small child is present in a forward-facing child restraint that is installed according to the manufacturer's instructions,
- the system determines that a small child is present in a booster seat,
- a front passenger takes his/her weight off of the seat for a period of time.

**Note:** When the passenger airbag off light is illuminated, the passenger (seat mounted) side airbag may be disabled to avoid the risk of airbag deployment injuries.

The front passenger sensing system uses a "passenger airbag off" or "pass airbag off" indicator which will illuminate and stay lit to remind you that the front passenger frontal airbag is disabled. The indicator lamp is located on the instrument panel to the right of the radio over the glove box.



**Note:** The indicator lamp will illuminate for a short period of time when the ignition is turned to the on position to confirm it is functional.

When the front passenger seat is not occupied (empty seat) or in the event that the front passenger frontal airbag is enabled (may inflate), the indicator lamp will be unlit.

The front passenger sensing system is designed to disable (will not inflate) the front passenger's frontal airbag when a rear facing infant seat, a forward-facing child restraint, or a booster seat is detected.

- When the front passenger sensing system disables (will not inflate) the front passenger frontal airbag, the indicator lamp will illuminate and stay lit to remind you that the front passenger frontal airbag is disabled.

## Seating and Safety Restraints

- If the child restraint has been installed and the indicator lamp is not lit, then turn the vehicle off, remove the child restraint from the vehicle and reinstall the restraint following the child restraint manufacturer's instructions.

The front passenger sensing system is designed to enable (may inflate) the front passenger's frontal airbag anytime the system senses that a person of adult size is sitting properly in the front passenger seat.

- When the front passenger sensing system enables the front passenger frontal airbag (may inflate), the indicator will be unlit and stay unlit.

If a person of adult size is sitting in the front passenger's seat, but the "passenger airbag off" or "pass airbag off" indicator lamp is lit, it is possible that the person isn't sitting properly in the seat. If this happens:

- Turn the vehicle off and ask the person to place the seatback in the full upright position.
- Have the person sit upright in the seat, centered on the seat cushion, with the person's legs comfortably extended.
- Restart the vehicle and have the person remain in this position for about two minutes. This will allow the system to detect that person and enable the passenger's frontal airbag.
- If the indicator lamp remains lit even after this, the person should be advised to ride in the rear seat.

Occupant	Pass Airbag Off Indicator Lamp	Passenger Airbag
Empty seat	Unlit	Disabled
Small child in child safety seat or booster	Lit	Disabled
Small child with safety belt buckled or unbuckled	Lit	Disabled
Adult	Unlit	Enabled



**WARNING:** Even with Advanced Restraints Systems, children 12 and under should be properly restrained in a rear seating position.

## Seating and Safety Restraints

After all occupants have adjusted their seats and put on safety belts, it's very important that they continue to sit properly. A properly seated occupant sits upright, leaning against the seat back, and centered on the seat cushion, with their feet comfortably extended on the floor. Sitting improperly can increase the chance of injury in a crash event. For example, if an occupant slouches, lies down, turns sideways, sits forward, leans forward or sideways, or puts one or both feet up, the chance of injury during a crash is greatly increased.



**WARNING:** Sitting improperly out of position or with the seat back reclined too far can take off weight from the seat cushion and affect the decision of the front passenger sensing system, resulting in serious injury or death in a crash. Always sit upright against your seatback, with your feet on the floor.

The front passenger sensing system may detect small or medium objects placed on the seat cushion. For most objects that are in the front passenger seat, the passenger airbag will be disabled. Even though the passenger airbag is disabled, the "pass airbag off" lamp may or may not be illuminated according to the table below.

Objects	Pass Airbag Off Indicator Lamp	Passenger Airbag
Small (i.e. three-ring binder, small purse, bottled water)	Unlit	Disabled
Medium (i.e. heavy briefcase, fully packed luggage)	Lit	Disabled
Empty seat, or small to medium object with safety belt buckled	Lit	Disabled

If you think that the status of the passenger airbag off indicator lamp is incorrect, check for the following:

- Objects lodged underneath the seat
- Objects between the seat cushion and the center console (if equipped)
- Objects hanging off the seat back
- Objects stowed in the seatback map pocket (if equipped)

## Seating and Safety Restraints

- Objects placed on the occupant's lap
- Cargo interference with the seat
- Other passengers pushing or pulling on the seat
- Rear passenger feet and knees resting or pushing on the seat

The conditions listed above may cause the weight of a properly seated occupant to be incorrectly interpreted by the front passenger sensing system. The person in the front passenger seat may appear heavier or lighter due to the conditions described in the list above.



**WARNING:** To reduce the risk of possible serious injury: Do not stow objects in seat back map pocket (if equipped) or hang objects off seat back if a child is in the front passenger seat. Do not place objects underneath the front passenger seat or between the seat and the center console (if equipped). Check the “passenger airbag off” or “pass airbag off” indicator lamp for proper airbag Status. Failure to follow these instructions may interfere with the front passenger seat sensing system.

In case there is a problem with the front passenger sensing system, the airbag readiness lamp in the instrument cluster will stay lit.



### **If the airbag readiness lamp is lit, do the following:**

The driver and/or adult passengers should check for any objects that may be lodged underneath the front passenger seat or cargo interfering with the seat.

If objects are lodged and/or cargo is interfering with the seat; please take the following steps to remove the obstruction:

- Pull the vehicle over.
- Turn the vehicle off.
- Driver and/or adult passengers should check for any objects lodged underneath the front passenger seat or cargo interfering with the seat.
- Remove the obstruction(s) (if found).
- Restart the vehicle.
- Wait at least two minutes and verify that the airbag readiness lamp is no longer illuminated



## Seating and Safety Restraints

- If the airbag readiness lamp remains illuminated, this may or may/not be a problem due to the front passenger sensing system.

DO NOT attempt to repair or service the system; take your vehicle immediately to an authorized dealer.



**WARNING:** The front passenger airbag is not designed to offer protection to an occupant in the center seating position.



**WARNING:** An out of position front center occupant could affect the decision of the front passenger sensing system.

If it is necessary to modify an advanced front airbag system to accommodate a person with disabilities, contact the Ford Customer Relationship Center at the phone number shown in the *Customer Assistance* section of this Owner's Guide.



**WARNING:** Any alteration/modification to the front passenger seat may affect the performance of the front passenger sensing system.

### Determining if the system is operational

The SRS uses a readiness light in the instrument cluster or a tone to indicate the condition of the system. Refer to the *Warning lights and chimes* section in the *Instrument Cluster* chapter. Routine maintenance of the airbag is not required.

A difficulty with the system is indicated by one or more of the following:

- The readiness light will either flash or stay lit.
- The readiness light will not illuminate immediately after ignition is turned on.
- A series of five beeps will be heard. The tone pattern will repeat periodically until the problem and/or light are repaired.



If any of these things happen, even intermittently, contact your authorized dealer as soon as possible. Unless serviced, the system may not function properly in the event of a collision.

## Seating and Safety Restraints

### Seat-mounted side airbag system

 **WARNING:** Do not place objects or mount equipment on or near the airbag cover on the side of the seatbacks of the front seats or in front seat areas that may come into contact with a deploying airbag. Failure to follow these instructions may increase the risk of personal injury in the event of a collision.

 **WARNING:** Do not use accessory seat covers. The use of accessory seat covers may prevent the deployment of the side airbags and increase the risk of injury in an accident.

 **WARNING:** Do not lean your head on the door. The side airbag could injure you as it deploys from the side of the seatback.

 **WARNING:** Do not attempt to service, repair, or modify the airbag SRS, its fuses or the seat cover on a seat containing an airbag. Contact your authorized dealer as soon as possible.

 **WARNING:** All occupants of the vehicle should always wear their safety belts even when an airbag SRS is provided.

## Seating and Safety Restraints

### ***How does the side airbag system work?***

The design and development of the side airbag system included recommended testing procedures that were developed by a group of automotive safety experts known as the Side Airbag Technical Working Group. These recommended testing procedures help reduce the risk of injuries related to the deployment of side airbags.

The side airbag system consists of the following:

- An inflatable bag (airbag) with a gas generator concealed behind the outboard bolster of the driver and front passenger seatbacks.
- A special seat cover designed to allow airbag deployment.
- The same warning light, electronic control and diagnostic unit as used for the front airbags.
- Two crash sensors located near the side of the vehicle.

Side airbags, in combination with safety belts, can help reduce the risk of severe injuries in the event of a significant side impact collision.

The side airbags are fitted on the outboard side of the seatbacks of the front seats. In certain lateral collisions, the airbag on the side affected by the collision will be inflated. The airbag was designed to inflate between the door panel and occupant to further enhance the protection provided occupants in side impact collisions.

The airbag SRS is designed to activate when the vehicle sustains lateral deceleration sufficient to cause the sensors to close an electrical circuit that initiates airbag inflation.

The fact that the airbags did not inflate in a collision does not mean that something is wrong with the system. Rather, it means the forces were not of the type sufficient to cause activation. Side airbags are designed to inflate in side-impact collisions, not roll-over, rear-impact, frontal or near-frontal collisions, unless the collision causes sufficient lateral deceleration.

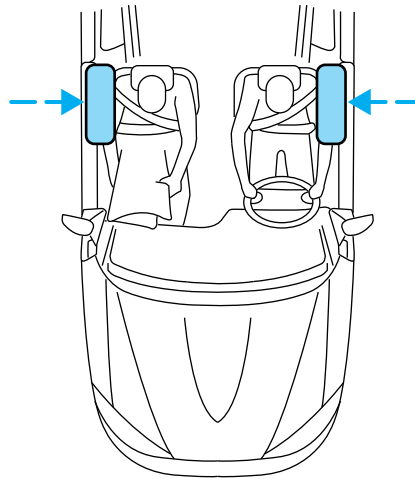

## Seating and Safety Restraints



**WARNING:** Several air bag system components get hot after inflation. Do not touch them after inflation.



**WARNING:** If the side airbag has deployed, **the airbag will not function again. The side airbag system (including the seat) must be inspected and serviced by an authorized dealer.** If the airbag is not replaced, the unrepaired area will increase the risk of injury in a collision.

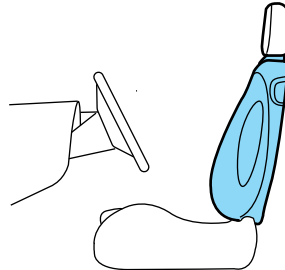

### ***Determining if the system is operational***

The SRS uses a readiness light in the instrument cluster or a tone to indicate the condition of the system. Refer to *Warning lights and chimes* in the *Instrument Cluster* chapter. Routine maintenance of the side airbag is not required.

A difficulty with the system is indicated by one or more of the following:

- The readiness light (same light as for front airbag system) will either flash or stay lit.
- The readiness light will not illuminate immediately after ignition is turned on.
- A series of five beeps will be heard. The tone pattern will repeat periodically until the problem and/or light are repaired.

If any of these things happen, even intermittently, have the SRS serviced at your authorized dealer immediately. Unless serviced, the system may not function properly in the event of a collision.

### **Disposal of airbags and airbag equipped vehicles (including pretensioners)**

Contact your authorized dealer as soon as possible. Airbags **MUST BE** disposed of by qualified personnel.

## Seating and Safety Restraints

### SAFETY RESTRAINTS FOR CHILDREN

See the following sections for directions on how to properly use safety restraints for children. Also see *Airbag supplemental restraint system (SRS)* in this chapter for special instructions about using airbags.

#### Important child restraint precautions



**WARNING:** Always make sure your child is secured properly in a device that is appropriate for their height, age and weight. Child safety restraints must be purchased separately from the vehicle. Failure to follow these instructions and guidelines may result in an increased risk of serious injury or death to your child.



**WARNING:** All children are shaped differently. The Recommendations for Safety Restraints are based on probable child height, age and weight thresholds from NHTSA and other safety organizations or are the minimum requirements of law. Ford recommends checking with a NHTSA Certified Child Passenger Safety Technician (CPST) and consult your pediatrician to make sure your child seat is appropriate for your child, and is compatible with and properly installed in the vehicle. To locate a child seat fitting station and CPST contact the NHTSA toll free at 1-888-327-4236 or on the internet at <http://www.nhtsa.dot.gov>. In Canada, check with your local St. John Ambulance office for referral to a CPST or for further information, contact your provincial ministry of transportation, your local St. John Ambulance office at <http://www.sfa.ca>, or Transport Canada at 1-800-333-0371 (<http://www.tc.gc.ca>). Failure to properly restrain children in safety seats made especially for their height, age, and weight may result in an increased risk of serious injury or death to your child.

## Seating and Safety Restraints

Recommendations for Safety Restraints for Children		
	Child size, height, weight, or age	Recommended restraint type
Infants or toddlers	Children weighing 40 lb (18 kg) or less (generally age four or younger)	Use a child safety seat (sometimes called an infant carrier, convertible seat, or toddler seat).
Small children	Children who have outgrown or no longer properly fit in a child safety seat (generally children who are less than 4 feet 9 inches (1.45 meters) tall, are greater than age four (4) and less than age twelve (12), and between 40 lb (18 kg) and 80 lb (36 kg) and upward to 100 lb (45 kg) if recommended by your child restraint manufacturer)	Use a belt-positioning booster seat.
Larger children	Children who have outgrown or no longer properly fit in a belt-positioning booster seat (generally children who are at least 4 feet 9 inches (1.45 meters) tall or greater than 80 lb (36 kg) or 100 lb (45 kg) if recommended by child restraint manufacturer)	Use a vehicle safety belt having the lap belt snug and low across the hips, shoulder belt centered across the shoulder and chest, and seatback upright.

- You are required by law to properly use safety seats for infants and toddlers in the U.S. and Canada.
- Many states and provinces require that small children use approved booster seats until they reach age eight, a height of 4 ft 9 in. (1.45 meters) tall, or 80 lb (36 kg). Check your local and state or provincial laws for specific requirements regarding the safety of children in your vehicle.
- When possible, always properly restrain children twelve (12) years of age and under in a rear seating position of your vehicle. Accident statistics suggest that children are safer when properly restrained in the rear seating positions than in a front seating position.

## Seating and Safety Restraints

### **Recommendations for attaching child safety restraints for children**

Restraint Type	Child Weight	Use any attachment method as indicated below by "X"				
		LATCH (lower anchors and top tether anchor)	LATCH (lower anchors only)	Safety belt and top tether anchor	Safety belt and LATCH (lower anchors and top tether anchor)	Safety belt only
Rear facing child seat	Up to 48 lb (21 kg)		X			X
Forward facing child seat	Up to 48 lb (21 kg)	X		X	X	
Forward facing child seat	Over 48 lb (21 kg)			X	X	

 **WARNING:** Airbags can kill or injure a child in a child seat. NEVER place a rear-facing child seat in front of an active airbag. If you must use a forward-facing child seat in the front seat, move the vehicle seat all the way back. When possible, all children age 12 and under should be properly restrained in a rear seating position. If all children cannot be seated and restrained properly in a rear seating position, properly restrain the largest child in the front seat.

 **WARNING:** Always carefully follow the instructions and warnings provided by the manufacturer of any child restraint to determine if the restraint device is appropriate for your child's size, height, weight, or age. Follow the child restraint manufacturer's instructions and warnings provided for installation and use in conjunction with the instructions and warnings provided by the vehicle manufacturer. A safety seat that is improperly installed or utilized, is inappropriate for your child's height, age, or weight or does not properly fit the child may increase the risk of serious injury or death.

## Seating and Safety Restraints

 **WARNING:** Never let a passenger hold a child on his or her lap while the vehicle is moving. The passenger cannot protect the child from injury in a collision, which may result in serious injury or death.

 **WARNING:** Never use pillows, books, or towels to boost a child. They can slide around and increase the likelihood of injury or death in a collision.

 **WARNING:** Always restrain an unoccupied child seat or booster seat. These objects may become projectiles in a collision or sudden stop, which may increase the risk of serious injury.

 **WARNING:** Never place, or allow a child to place, the shoulder belt under a child's arm or behind the back because it reduces the protection for the upper part of the body and may increase the risk of injury or death in a collision.

 **WARNING:** Do not leave children, unreliable adults, or pets unattended in your vehicle.

### Transporting children

Always make sure your child is secured properly in a device that is appropriate for their age, height and weight. All children are shaped differently. The child height, age and weight thresholds provided are recommendations or the minimum requirements of law. The National Highway Traffic Safety Administration (NHTSA) provides education and training to ensure that all children ages 0 to 16 are properly restrained in the correct restraint system. Ford recommends checking with a NHTSA Certified Child Passenger Safety Technician (CPST) and your pediatrician to make sure your seat is appropriate for your child and properly installed in the vehicle. To locate a child seat fitting station and CPST contact the NHTSA toll free at **1-888-327-4236** or on the internet at <http://www.nhtsa.dot.gov>. In Canada, check with your local St. John Ambulance office for referral to a CPST or for further information, contact your provincial ministry of transportation, your local St. John Ambulance office at <http://www.sfa.ca>, or Transport Canada at 1-800-333-0371 (<http://www.tc.gc.ca>).



## Seating and Safety Restraints

Follow all the safety restraint and airbag precautions that apply to adult passengers in your vehicle.

If the child is the proper height, age, and weight (as specified by your child safety seat or booster manufacturer), fits the restraint and can be restrained properly, then restrain the child in the child safety seat or with the belt-positioning booster. Remember that child seats and belt-positioning boosters vary and may be designed to fit children of different heights, ages and weights. Children who are too large for child safety seats or belt-positioning boosters (as specified by your child safety seat manufacturer) should always properly wear safety belts.

### SAFETY SEATS FOR CHILDREN

#### Infant and/or toddler seats

Use a safety seat that is recommended for the size and weight of the child.

When installing a child safety seat:

- Review and follow the information presented in the *Airbag supplemental restraint system (SRS)* section in this chapter.
- Carefully follow all of the manufacturer's instructions included with the safety seat you put in your vehicle. If you do not install and use the safety seat properly, the child may be injured in a sudden stop or collision.

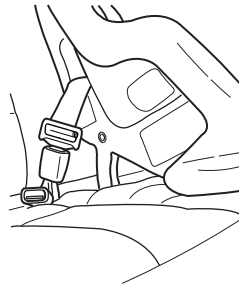

Airbags can kill or injure a child in a child seat. NEVER place a rear-facing child seat in front of an active airbag. If you must use a forward-facing child seat in the front seat, move the vehicle seat all the way back.

Children 12 and under should be properly restrained in a rear seating position whenever possible. If all children cannot be seated and restrained properly in a rear seating position, properly restrain the largest child in the front seat.

#### Installing child safety seats with combination lap and shoulder belts

Check to make sure the child seat is properly secured before each use. Children 12 and under should be properly restrained in a rear seating

## Seating and Safety Restraints

position whenever possible. If all children cannot be seated and restrained properly in a rear seating position, properly restrain the largest child in the front seat.

When installing a child safety seat with combination lap/shoulder belts:

- Use the correct safety belt buckle for that seating position.
- Insert the belt tongue into the proper buckle until you hear a snap and feel it latch. Make sure the tongue is securely fastened in the buckle.
- Keep the buckle release button pointing up and away from the safety seat, with the tongue between the child seat and the release button, to help prevent accidental unbuckling.
- Place vehicle seat back in upright position.
- Put the safety belt in the automatic locking mode. Refer to Step 5 below. This vehicle does not require the use of a locking clip.



**WARNING:** Depending on where you secure a child restraint, and depending on the child restraint design, you may block access to certain safety belt buckle assemblies and/or LATCH lower anchors, rendering those features potentially unusable. To avoid risk of injury, occupants should only use seating positions where they are able to be properly restrained.

Perform the following steps when installing the child seat with combination lap/shoulder belts:

**Note:** Although the child seat illustrated is a forward facing child seat, the steps are the same for installing a rear facing child seat.

1. Position the child safety seat in a seat with a combination lap and shoulder belt.

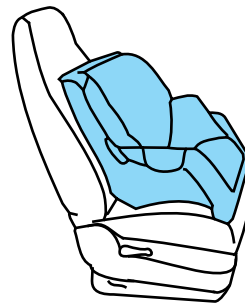

## Seating and Safety Restraints

2. Pull down on the shoulder belt and then grasp the shoulder belt and lap belt together.

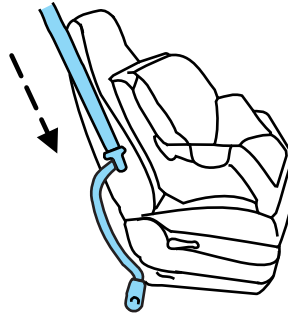

3. While holding the shoulder and lap belt portions together, route the tongue through the child seat according to the child seat manufacturer's instructions. Be sure the belt webbing is not twisted.

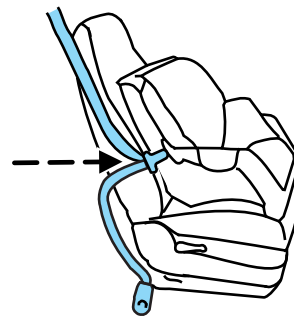

4. Insert the belt tongue into the proper buckle (the buckle closest to the direction the tongue is coming from) for that seating position until you hear a snap and feel the latch engage. Make sure the tongue is latched securely by pulling on it.

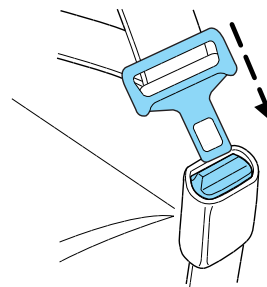

## Seating and Safety Restraints

5. To put the retractor in the automatic locking mode, grasp the shoulder portion of the belt and pull downward until all of the belt is pulled out.

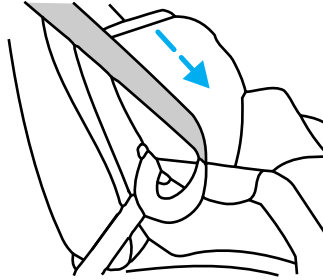

6. Allow the belt to retract to remove slack. The belt will click as it retracts to indicate it is in the automatic locking mode.

7. Try to pull the belt out of the retractor to make sure the retractor is in the automatic locking mode (you should not be able to pull more belt out). If the retractor is not locked, repeat Steps 5 and 6.

8. Remove remaining slack from the belt. Force the seat down with extra weight, e.g., by pressing down or kneeling on the child restraint while pulling up on the shoulder belt in order to force slack from the belt. This is necessary to remove the remaining slack that will exist once the additional weight of the child is added to the child restraint. It also helps to achieve the proper snugness of the child seat to the vehicle. Sometimes, a slight lean towards the buckle will additionally help to remove remaining slack from the belt.

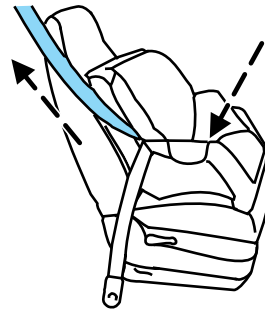

9. Attach the tether strap (if the child seat is equipped). Refer to *Attaching child safety seats with tether straps* later in this chapter.

## Seating and Safety Restraints

10. Before placing the child in the seat, forcibly move the seat forward and back to make sure the seat is securely held in place. To check this, grab the seat at the belt path and attempt to move it side to side and forward and back. There should be no more than 1 inch (2.5 cm) of movement for proper installation.

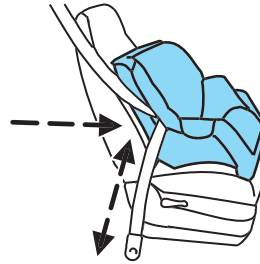

Ford recommends checking with a NHTSA Certified Child Passenger Safety Technician (CPST) to make certain the child restraint is properly installed. In Canada, check with your local St. John Ambulance office for referral to a CPST.

### ***Installing child safety seats in the lap belt seating positions***



**WARNING:** Installing a child safety seat in the front row lap seating position should be avoided if at all possible.



**WARNING:** Never place a rear-facing child seat in the front center seating position of a vehicle with rear seating positions.



**WARNING:** Front seating positions only: If seating two adults and a child, Ford recommends properly restraining the child in the center front seating position, but only if doing so will not interfere with driving the vehicle. This arrangement provides lap and shoulder belt and airbag protection for adult occupants and an attachment method for a child restraint. If the child seat interferes with driving the vehicle and the child restraint is forward-facing, the child may be restrained in the passenger seat. Move the seat as far rearward as possible to minimize the likelihood of interaction with the front passenger airbag. Never place a rear-facing child seat in front of an active airbag. All occupants of the vehicle should always properly wear their safety belts. Ensure the child is properly restrained in an appropriate child seat or with the use of a booster.

## Seating and Safety Restraints

1. Lengthen the lap belt. To lengthen the belt, hold the tongue so that its bottom is perpendicular to the direction of webbing while sliding the tongue up the webbing.

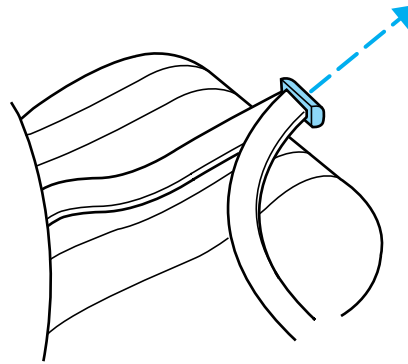

2. Place the child safety seat in the center seating position.
3. Route the tongue and webbing through the child seat according to the child seat manufacturer's instructions.
4. Insert the belt tongue into the proper buckle for the center seating position until you hear a snap and feel it latch. Make sure the tongue is securely fastened to the buckle by pulling on the tongue.
5. Push down on the child seat while pulling on the loose end of the lap belt webbing to tighten the belt.
6. Before placing the child into the child seat, forcibly tilt the child seat from side to side and in forward direction to make sure that the seat is securely held in place. To check this, grab the seat at the belt path and attempt to move it side to side and forward and back. There should be no more than 1 inch (2.5 cm) of movement for proper installation.
7. Ford recommends checking with a NHTSA Certified Child Passenger Safety Technician (CPST) to make certain the child restraint is properly installed. In Canada, check with your local St. John Ambulance office for referral to a CPST.

**Note:** There is no top tether anchor for the front center seating position. See *Attaching child safety seats with tether straps* later in this chapter.

### **Attaching child safety seats with LATCH (Lower Anchors and Tethers for Children) attachments**

The LATCH system is composed of three vehicle anchor points: two (2) lower anchors located where the vehicle seat back and seat cushion meet (called the “seat bight”) and one (1) top tether anchor located behind that seating position.

## Seating and Safety Restraints

LATCH compatible child safety seats have two rigid or webbing mounted attachments that connect to the two lower anchors at the LATCH equipped seating positions in your vehicle. This type of attachment method eliminates the need to use safety belts to attach the child seat, however the safety belt can still be used to attach the child seat. For forward-facing child seats, the top tether strap must also be attached to the proper top tether anchor, if a top tether strap has been provided with your child seat. Ford Motor Company recommends the use of a child safety seat having a top tether strap. See *Attaching child safety seats with tether straps* and *Recommendations for attaching safety restraints for children* in this chapter for more information.

Your vehicle has LATCH lower anchors for child seat installation at the seating positions marked with the child seat symbol.

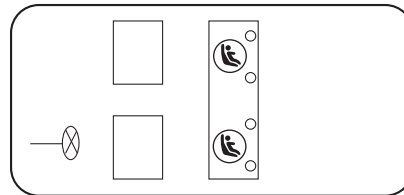

The LATCH anchors are located at the rear section of the rear seat between the cushion and seatback. Follow the child seat manufacturer's instructions to properly install a child seat with LATCH attachments.

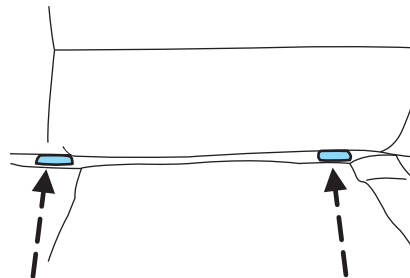

Follow the instructions on attaching child safety seats with tether straps. Refer to *Attaching child safety seats with tether straps* later in this chapter.

Attach LATCH lower attachments of the child seat only to the anchors shown.



**WARNING:** Never attach two child safety seats to the same anchor. In a crash, one anchor may not be strong enough to hold two child safety seat attachments and may break, causing serious injury or death.

## Seating and Safety Restraints



**WARNING:** Depending on where you secure a child restraint, and depending on the child restraint design, you may block access to certain safety belt buckle assemblies and/or LATCH lower anchors, rendering those features potentially unusable. To avoid risk of injury, occupants should only use seating positions where they are able to be properly restrained.

### ***Use of inboard lower anchors from the outboard seating positions (center seating use)***

The lower anchors at the center of the second row rear seat are spaced 578 mm (23 inches) apart. The standardized spacing for LATCH lower anchors is 280 mm (11 inches) center to center. A child seat with rigid LATCH attachments cannot be installed at the center seating position. LATCH compatible child seats (with attachments on belt webbing) can only be used at this seating position provided that the child seat manufacturer's instructions permit use with the anchor spacing stated. Do not attach a child seat to any lower anchor if an adjacent child seat is attached to that anchor.



**WARNING:** The standardized spacing for LATCH lower anchors is 280 mm (11 inches) center to center. Do not use LATCH lower anchors for the center seating position unless the child seat manufacturer's instructions permit and specify using anchors spaced at least as far apart as those in this vehicle.

Each time you use the safety seat, check that the seat is properly attached to the lower anchors and tether anchor, if applicable. Tug the child seat from side to side and forward and back where it is secured to the vehicle. The seat should move less than one inch when you do this for a proper installation.

If the safety seat is not anchored properly, the risk of a child being injured in a crash greatly increases.

### ***Combining safety belt and LATCH lower anchors for attaching child safety seats***

When used in combination, either the safety belt or the LATCH lower anchors may be attached first, provided a proper installation is achieved. Attach the tether strap afterward, if included with the child seat. Refer to *Recommendations for attaching child safety restraints for children* in this chapter.



## Seating and Safety Restraints

### Attaching child safety seats with tether straps

Many forward-facing child safety seats include a tether strap which extends from the back of the child safety seat and hooks to an anchoring point called the top tether anchor. Tether straps are available as an accessory for many older safety seats. Contact the manufacturer of your child seat for information about ordering a tether strap, or to obtain a longer tether strap if the tether strap on your safety seat does not reach the appropriate top tether anchor in the vehicle.

The rear seats of your vehicle are equipped with built-in tether strap anchors located behind the seats as described below.

The tether anchors in your vehicle are located under a cover marked with the tether anchor symbol (shown with title).

The tether strap anchors in your vehicle are in the following positions (shown from top view):

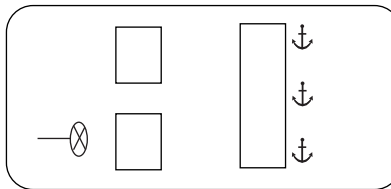

Attach the tether strap only to the appropriate tether anchor as shown. The tether strap may not work properly if attached somewhere other than the correct tether anchor.

Once the child safety seat has been installed, using either the safety belt, the lower anchors of the LATCH system, or both, you can attach the top tether strap.

If you install a child seat with rigid LATCH attachments, and have attached the top tether strap to the proper top tether anchor, do not tighten the tether strap enough to lift the child seat off the vehicle seat cushion when the child is seated in it. Keep the tether strap just snug without lifting the front of the child seat. Keeping the child seat just touching the vehicle seat gives the best protection in a severe crash.

Perform the following steps to install a child safety seat to the tether anchor:

1. Route the child safety seat tether strap over the back of the seat.

For vehicles with adjustable head restraints, route the tether strap under the head restraint and between the head restraint posts, otherwise route the tether strap over the top of the seatback.

## Seating and Safety Restraints

2. Locate the correct anchor for the selected seating position.



3. Open the tether anchor cover.

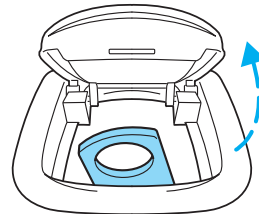

4. Clip the tether strap to the anchor as shown.

If the tether strap is clipped incorrectly, the child safety seat may not be retained properly in the event of a collision.

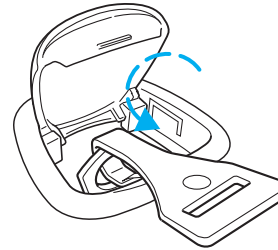

5. Tighten the child safety seat tether strap according to the manufacturer's instructions.

If the safety seat is not anchored properly, the risk of a child being injured in a collision greatly increases.

If your child restraint system is equipped with a tether strap, and the child restraint manufacturer recommends its use, Ford also recommends its use.

### Child booster seats

The belt-positioning booster (booster seat) is used to improve the fit of the vehicle safety belt. Children outgrow a typical child seat (e.g., convertible or toddler seat) when they weigh about 40 lb (18 kg) and are around four (4) years of age. Consult your child safety seat owner guide for the weight, height, and age limits specific to your child safety seat. Keep your child in the child safety seat if it properly fits the child, remains appropriate for their weight, height and age AND if properly secured to the vehicle.

## Seating and Safety Restraints

Although the lap/shoulder belt will provide some protection, children who have outgrown a typical child seat are still too small for lap/shoulder belts to fit properly, and wearing an improperly fitted vehicle safety belt could increase the risk of serious injury in a crash. To improve the fit of both the lap and shoulder belt on children who have outgrown child safety seats, Ford Motor Company recommends use of a belt-positioning booster.

Booster seats position a child so that vehicle lap/shoulder safety belts fit better. They lift the child up so that the lap belt rests low across the hips and the knees bend comfortably at the edge of the cushion, while minimizing slouching. Booster seats may also make the shoulder belt fit better and more comfortably. Try to keep the belt near the middle of the shoulder and across the center of the chest. Moving the child closer (a few centimeters or inches) to the center of the vehicle, but remaining in the same seating position, may help provide a good shoulder belt fit.

### **When children should use booster seats**

Children need to use booster seats from the time they outgrow the toddler seat until they are big enough for the vehicle seat and lap/shoulder belt to fit properly. Generally this is when they reach a height of at least 4 feet 9 inches (1.45 meters) tall (around age eight to age twelve and between 40 lb (18 kg) and 80 lb (36 kg) or upward to 100 lb (45 kg) if recommended by your child restraint manufacturer). Many state and provincial laws require that children use approved booster seats until they reach age eight, a height of 4 feet 9 inches (1.45 meters) tall, or 80 lb (36 kg).

Booster seats should be used until you can answer YES to ALL of these questions when seated without a booster seat:

- Can the child sit all the way back against the vehicle seat back with knees bent comfortably at the edge of the seat cushion?
- Can the child sit without slouching?

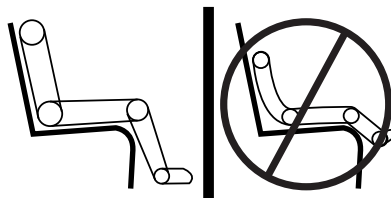

- Does the lap belt rest low across the hips?
- Is the shoulder belt centered on the shoulder and chest?
- Can the child stay seated like this for the whole trip?

## Seating and Safety Restraints

### **Types of booster seats**

There are generally two types of belt-positioning booster seats: backless and high back. Always use booster seats in conjunction with the vehicle lap/shoulder belt.

- **Backless booster seats**

If your backless booster seat has a removable shield, remove the shield. If a vehicle seating position has a low seat back or no head restraint, a backless booster seat may place your child's head (as measured at the tops of the ears) above the top of the seat. In this case, move the backless booster to another seating position with a higher seat back or head restraint and lap/shoulder belts, or consider using a high back booster seat.



- **High back booster seats**

If, with a backless booster seat, you cannot find a seating position that adequately supports your child's head, a high back booster seat would be a better choice.



## Seating and Safety Restraints

Children and booster seats vary in size and shape. Choose a booster that keeps the lap belt low and snug across the hips, never up across the stomach, and lets you adjust the shoulder belt to cross the chest and rest snugly near the center of the shoulder. The drawings below compare the ideal fit (center) to a shoulder belt uncomfortably close to the neck and a shoulder belt that could slip off the shoulder. The drawings below also show how the lap belt should be low and snug across the child's hips.

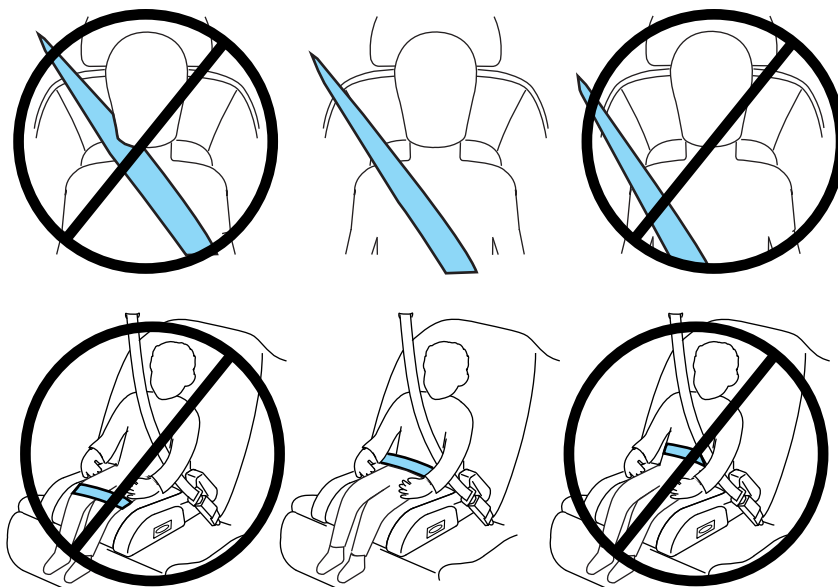

If the booster seat slides on the vehicle seat, placing a rubberized mesh sold as shelf or carpet liner under the booster seat may improve this condition. Do not introduce any item thicker than this under the booster seat. Check with the booster seat manufacturer's instructions.

### ***The importance of shoulder belts***

Using a booster without a shoulder belt increases the risk of a child's head hitting a hard surface in a collision. For this reason, you should never use a booster seat with a lap belt only. It is generally best to use a booster seat with lap/shoulder belts in the back seat.

Move a child to a different seating location if the shoulder belt does not stay positioned on the shoulder during use.

## Seating and Safety Restraints

Follow all instructions provided by the manufacturer of the booster seat.



**WARNING:** Never place, or allow a child to place, the shoulder belt under a child's arm or behind the back because it reduces the protection for the upper part of the body and may increase the risk of injury or death in a collision.

### Child restraint and safety belt maintenance

Inspect the vehicle safety belts and child safety seat systems periodically to make sure they work properly and are not damaged. Inspect the vehicle and child seat safety belts to make sure there are no nicks, tears or cuts. Replace if necessary. All vehicle safety belt assemblies, including retractors, buckles, front safety belt buckle assemblies, buckle support assemblies (slide bar-if equipped), shoulder belt height adjusters (if equipped), shoulder belt guide on seatback (if equipped), child safety seat LATCH and tether anchors, and attaching hardware, should be inspected after a collision. Refer to the child restraint manufacturer's instructions for additional inspection and maintenance information specific to the child restraint. Ford Motor Company recommends that all safety belt assemblies in use in vehicles involved in a collision be replaced. However, if the collision was minor and an authorized dealer finds that the belts do not show damage and continue to operate properly, they do not need to be replaced. Safety belt assemblies not in use during a collision should also be inspected and replaced if either damage or improper operation is noted.

For proper care of soiled safety belts, refer to *Interior* in the *Cleaning* chapter.



**WARNING:** Failure to inspect and if necessary replace the safety belt assembly or child restraint system under the above conditions could result in severe personal injuries in the event of a collision.

## Tires, Wheels and Loading

### INFORMATION ABOUT UNIFORM TIRE QUALITY GRADING

Tire Quality Grades apply to new pneumatic passenger car tires. The Quality grades can be found where applicable on the tire sidewall between tread shoulder and maximum section width. For example:

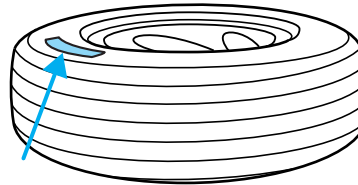

- **Treadwear 200 Traction AA Temperature A**

These Tire Quality Grades are determined by standards that the United States Department of Transportation has set.

Tire Quality Grades apply to new pneumatic passenger car tires. They do not apply to deep tread, winter-type snow tires, space-saver or temporary use spare tires, light truck or "LT" type tires, tires with nominal rim diameters of 10 to 12 inches or limited production tires as defined in Title 49 Code of Federal Regulations Part 575.104(c)(2).

**U.S. Department of Transportation-Tire quality grades:** The U.S. Department of Transportation requires Ford Motor Company to give you the following information about tire grades exactly as the government has written it.

#### **Treadwear**

The treadwear grade is a comparative rating based on the wear rate of the tire when tested under controlled conditions on a specified government test course. For example, a tire graded 150 would wear one and one-half (1½) times as well on the government course as a tire graded 100. The relative performance of tires depends upon the actual conditions of their use, however, and may depart significantly from the norm due to variations in driving habits, service practices, and differences in road characteristics and climate.

#### **Traction AA A B C**

The traction grades, from highest to lowest are AA, A, B, and C. The grades represent the tire's ability to stop on wet pavement as measured under controlled conditions on specified government test surfaces of asphalt and concrete. A tire marked C may have poor traction performance.

## Tires, Wheels and Loading



**WARNING:** The traction grade assigned to this tire is based on straight-ahead braking traction tests, and does not include acceleration, cornering, hydroplaning or peak traction characteristics.

### Temperature A B C

The temperature grades are A (the highest), B and C, representing the tire's resistance to the generation of heat and its ability to dissipate heat when tested under controlled conditions on a specified indoor laboratory test wheel. Sustained high temperature can cause the material of the tire to degenerate and reduce tire life, and excessive temperature can lead to sudden tire failure. The grade C corresponds to a level of performance which all passenger car tires must meet under the Federal Motor Vehicle Safety Standard No. 139. Grades B and A represent higher levels of performance on the laboratory test wheel than the minimum required by law.



**WARNING:** The temperature grade for this tire is established for a tire that is properly inflated and not overloaded. Excessive speed, underinflation, or excessive loading, either separately or in combination, can cause heat buildup and possible tire failure.

### TIRES

Tires are designed to give many thousands of miles of service, but they must be maintained in order to get the maximum benefit from them.

#### Glossary of tire terminology

- **Tire label:** A label showing the OE (Original Equipment) tire sizes, recommended inflation pressure and the maximum weight the vehicle can carry.
- **Tire Identification Number (TIN):** A number on the sidewall of each tire providing information about the tire brand and manufacturing plant, tire size and date of manufacture. Also referred to as DOT code.
- **Inflation pressure:** A measure of the amount of air in a tire.
- **Standard load:** A class of P-metric or Metric tires designed to carry a maximum load at 35 psi [37 psi (2.5 bar) for Metric tires]. Increasing the inflation pressure beyond this pressure will not increase the tire's load carrying capability.
- **Extra load:** A class of P-metric or Metric tires designed to carry a heavier maximum load at 41 psi [43 psi (2.9 bar) for Metric tires].



## Tires, Wheels and Loading

Increasing the inflation pressure beyond this pressure will not increase the tire's load carrying capability.

- **kPa:** Kilopascal, a metric unit of air pressure.
- **PSI:** Pounds per square inch, a standard unit of air pressure.
- **Cold inflation pressure:** The tire pressure when the vehicle has been stationary and out of direct sunlight for an hour or more and prior to the vehicle being driven for 1 mile (1.6 km).
- **Recommended inflation pressure:** The cold inflation pressure found on the Safety Compliance Certification Label or Tire Label located on the B-Pillar or the edge of the driver's door.
- **B-pillar:** The structural member at the side of the vehicle behind the front door.
- **Bead area of the tire:** Area of the tire next to the rim.
- **Sidewall of the tire:** Area between the bead area and the tread.
- **Tread area of the tire:** Area of the perimeter of the tire that contacts the road when mounted on the vehicle.
- **Rim:** The metal support (wheel) for a tire or a tire and tube assembly upon which the tire beads are seated.

### INFLATING YOUR TIRES

Safe operation of your vehicle requires that your tires are properly inflated. Remember that a tire can lose up to half of its air pressure without appearing flat.

Every day before you drive, check your tires. If one looks lower than the others, use a tire gauge to check pressure of all tires and adjust if required.

At least once a month and before long trips, inspect each tire and check the tire pressure with a tire gauge (including spare, if equipped). Inflate all tires to the inflation pressure recommended by Ford Motor Company.

You are strongly urged to buy a reliable tire pressure gauge, as automatic service station gauges may be inaccurate. Ford recommends the use of a digital or dial-type tire pressure gauge rather than a stick-type tire pressure gauge.

Use the recommended cold inflation pressure for optimum tire performance and wear. Under-inflation or over-inflation may cause uneven treadwear patterns.

## Tires, Wheels and Loading



**WARNING:** Under-inflation is the most common cause of tire failures and may result in severe tire cracking, tread separation or “blowout”, with unexpected loss of vehicle control and increased risk of injury. Under-inflation increases sidewall flexing and rolling resistance, resulting in heat buildup and internal damage to the tire. It also may result in unnecessary tire stress, irregular wear, loss of vehicle control and accidents. A tire can lose up to half of its air pressure and not appear to be flat!

Always inflate your tires to the Ford recommended inflation pressure even if it is less than the maximum inflation pressure information found on the tire. The Ford recommended tire inflation pressure is found on the Safety Compliance Certification Label or Tire Label which is located on the B-Pillar or the edge of the driver's door. Failure to follow the tire pressure recommendations can cause uneven treadwear patterns and adversely affect the way your vehicle handles.

**Maximum Permissible Inflation Pressure** is the tire manufacturer's maximum permissible pressure and/or the pressure at which the maximum load can be carried by the tire. This pressure is normally higher than the manufacturer's recommended cold inflation pressure which can be found on the Safety Compliance Certification Label or Tire Label which is located on the B-Pillar or the edge of the driver's door. The cold inflation pressure should never be set lower than the recommended pressure on the Safety Compliance Certification Label or Tire Label.

When weather temperature changes occur, tire inflation pressures also change. A 10°F (6°C) temperature drop can cause a corresponding drop of 1 psi (7 kPa) in inflation pressure. Check your tire pressures frequently and adjust them to the proper pressure which can be found on the Safety Compliance Certification Label or Tire Label.

To check the pressure in your tire(s):

1. Make sure the tires are cool, meaning they are not hot from driving even a mile.

If you are checking tire pressure when the tire is hot, (i.e. driven more than 1 mile [1.6 km]), never “bleed” or reduce air pressure. The tires are hot from driving and it is normal for pressures to increase above recommended cold pressures. A hot tire at or below recommended cold inflation pressure could be significantly under-inflated.

## Tires, Wheels and Loading

**Note:** If you have to drive a distance to get air for your tire(s), check and record the tire pressure first and add the appropriate air pressure when you get to the pump. It is normal for tires to heat up and the air pressure inside to go up as you drive.

2. Remove the cap from the valve on one tire, then firmly press the tire gauge onto the valve and measure the pressure.

3. Add enough air to reach the recommended air pressure.

**Note:** If you overfill the tire, release air by pressing on the metal stem in the center of the valve. Then recheck the pressure with your tire gauge.

4. Replace the valve cap.

5. Repeat this procedure for each tire, including the spare.

**Note:** Some spare tires operate at a higher inflation pressure than the other tires. For T-type/mini-spare tires (see the *Dissimilar spare tire/wheel information* section for description): Store and maintain at 60 psi (4.15 bar). For full-size and dissimilar spare tires (see the *Dissimilar spare tire/wheel information* section for description): Store and maintain at the higher of the front and rear inflation pressure as shown on the Tire Label.

6. Visually inspect the tires to make sure there are no nails or other objects embedded that could poke a hole in the tire and cause an air leak.

7. Check the sidewalls to make sure there are no gouges, cuts or bulges.

### TIRE CARE

#### Inspecting your tires and wheel valve stems

Periodically inspect the tire treads for uneven or excessive wear and remove objects such as stones, nails or glass that may be wedged in the tread grooves. Check the tire and valve stems for holes, cracks, or cuts that may permit air leakage and repair or replace the tire and replace the valve stem. Inspect the tire sidewalls for cracking, cuts, bruises and other signs of damage or excessive wear. If internal damage to the tire is suspected, have the tire demounted and inspected in case it needs to be repaired or replaced. For your safety, tires that are damaged or show signs of excessive wear should not be used because they are more likely to blow out or fail.

## Tires, Wheels and Loading

Improper or inadequate vehicle maintenance can cause tires to wear abnormally. Inspect all your tires, including the spare, frequently, and replace them if one or more of the following conditions exist:

### Tire wear

When the tread is worn down to 1/16th of an inch (2 mm), tires must be replaced to help prevent your vehicle from skidding and hydroplaning. Built-in treadwear indicators, or “wear bars”, which look like narrow strips of smooth rubber across the tread will appear on the tire when the tread is worn down to 1/16th of an inch (2 mm).

When the tire tread wears down to the same height as these “wear bars”, the tire is worn out and must be replaced.

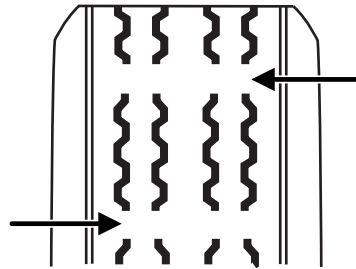

### Damage

Periodically inspect the tire treads and sidewalls for damage (such as bulges in the tread or sidewalls, cracks in the tread groove and separation in the tread or sidewall). If damage is observed or suspected have the tire inspected by a tire professional. Tires can be damaged during off-road use, so inspection after off-road use is also recommended.



### **WARNING: Age**

Tires degrade over time depending on many factors such as weather, storage conditions, and conditions of use (load, speed, inflation pressure, etc.) the tires experience throughout their lives. In general, tires should be replaced after six years regardless of tread wear. However, heat caused by hot climates or frequent high loading conditions can accelerate the aging process and may require tires to be replaced more frequently.

You should replace your spare tire when you replace the road tires or after six years due to aging even if it has not been used.

## Tires, Wheels and Loading

### U.S. DOT Tire Identification Number (TIN)

Both U.S. and Canada Federal regulations require tire manufacturers to place standardized information on the sidewall of all tires. This information identifies and describes the fundamental characteristics of the tire and also provides a U.S. DOT Tire Identification Number for safety standard certification and in case of a recall.

This begins with the letters “DOT” and indicates that the tire meets all federal standards. The next two numbers or letters are the plant code designating where it was manufactured, the next two are the tire size code and the last four numbers represent the week and year the tire was built. For example, the numbers 317 mean the 31st week of 1997. After 2000 the numbers go to four digits. For example, 2501 means the 25th week of 2001. The numbers in between are identification codes used for traceability. This information is used to contact customers if a tire defect requires a recall.

### Tire replacement requirements

Your vehicle is equipped with tires designed to provide a safe ride and handling capability.



**WARNING:** Only use replacement tires and wheels that are the same size, load index, speed rating and type (such as P-metric versus LT-metric or all-season versus all-terrain) as those originally provided by Ford. The recommended tire and wheel size may be found on either the Safety Compliance Certification Label or the Tire Label which is located on the B-Pillar or edge of the driver's door. If this information is not found on these labels then you should contact your authorized dealer as soon as possible. Use of any tire or wheel not recommended by Ford can affect the safety and performance of your vehicle, which could result in an increased risk of loss of vehicle control, vehicle rollover, personal injury and death. Additionally the use of non-recommended tires and wheels could cause steering, suspension, axle or transfer case/power transfer unit failure. If you have questions regarding tire replacement, contact your authorized dealer as soon as possible.

## Tires, Wheels and Loading



**WARNING:** When mounting replacement tires and wheels, you should not exceed the maximum pressure indicated on the sidewall of the tire to set the beads without additional precautions listed below. If the beads do not seat at the maximum pressure indicated, re-lubricate and try again.

When inflating the tire for mounting pressures up to 20 psi (1.38 bar) greater than the maximum pressure on the tire sidewall, the following precautions must be taken to protect the person mounting the tire:

1. Make sure that you have the correct tire and wheel size.
2. Lubricate the tire bead and wheel bead seat area again.
3. Stand at a minimum of 12 ft (3.66 m) away from the tire wheel assembly.
4. Use both eye and ear protection.

For a mounting pressure more than 20 psi (1.38 bar) greater than the maximum pressure, a Ford dealer or other tire service professional should do the mounting.

Always inflate steel carcass tires with a remote air fill with the person inflating standing at a minimum of 12 ft (3.66 m) away from the tire wheel assembly.

**Important:** Remember to replace the wheel valve stems when the road tires are replaced on your vehicle.

It is recommended that the two front tires or two rear tires generally be replaced as a pair.

The tire pressure sensors mounted in the wheels (originally installed on your vehicle) are not designed to be used in aftermarket wheels.

The use of wheels or tires not recommended by Ford Motor Company may affect the operation of your tire pressure monitoring system.

If the TPMS indicator is flashing, your TPMS is malfunctioning. Your replacement tire might be incompatible with your TPMS, or some component of the TPMS may be damaged.

### Safety practices

Driving habits have a great deal to do with your tire mileage and safety.

- Observe posted speed limits
- Avoid fast starts, stops and turns
- Avoid potholes and objects on the road

## Tires, Wheels and Loading

- Do not run over curbs or hit the tire against a curb when parking



**WARNING:** If your vehicle is stuck in snow, mud, sand, etc., **do not** rapidly spin the tires; spinning the tires can tear the tire and cause an explosion. A tire can explode in as little as three to five seconds.



**WARNING:** Do not spin the wheels at over 35 mph (56 km/h). The tires may fail and injure a passenger or bystander.

### Highway hazards

No matter how carefully you drive there's always the possibility that you may eventually have a flat tire on the highway. Drive slowly to the closest safe area out of traffic. This may further damage the flat tire, but your safety is more important.

If you feel a sudden vibration or ride disturbance while driving, or you suspect your tire or vehicle has been damaged, immediately reduce your speed. Drive with caution until you can safely pull off the road. Stop and inspect the tires for damage. If a tire is under-inflated or damaged, deflate it, remove wheel and replace it with your spare tire and wheel. If you cannot detect a cause, have the vehicle towed to the nearest repair facility or tire dealer to have the vehicle inspected.

### Tire and wheel alignment

A bad jolt from hitting a curb or pothole can cause the front end of your vehicle to become misaligned or cause damage to your tires. If your vehicle seems to pull to one side when you're driving, the wheels may be out of alignment. Have an authorized dealer check the wheel alignment periodically.

Wheel misalignment in the front or the rear can cause uneven and rapid treadwear of your tires and should be corrected by an authorized dealer. Front-wheel drive (FWD) vehicles and those with an independent rear suspension (if equipped) may require alignment of all four wheels.

The tires should also be balanced periodically. An unbalanced tire and wheel assembly may result in irregular tire wear.

### Tire rotation

Rotating your tires at the recommended interval (as indicated in the *Scheduled Maintenance* chapter) will help your tires wear more evenly, providing better tire performance and longer tire life.

## Tires, Wheels and Loading

- Rear-wheel drive (RWD) vehicles  
(front tires at top of diagram)

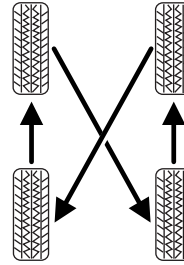

Sometimes irregular tire wear can be corrected by rotating the tires.

**Note:** If your tires show uneven wear ask an authorized dealer to check for and correct any wheel misalignment, tire imbalance or mechanical problem involved before tire rotation.

**Note:** Your vehicle may be equipped with a dissimilar spare tire/wheel. A dissimilar spare tire/wheel is defined as a spare tire and/or wheel that is different in brand, size or appearance from the road tires and wheels. If you have a dissimilar spare tire/wheel it is intended for temporary use only and should not be used in a tire rotation.

**Note:** After having your tires rotated, inflation pressure must be checked and adjusted to the vehicle requirements.

### INFORMATION CONTAINED ON THE TIRE SIDEWALL

Both U.S. and Canada Federal regulations require tire manufacturers to place standardized information on the sidewall of all tires. This information identifies and describes the fundamental characteristics of the tire and also provides a U.S. DOT Tire Identification Number for safety standard certification and in case of a recall.



## Tires, Wheels and Loading

### Information on “P” type tires

P215/65R15 95H is an example of a tire size, load index and speed rating. The definitions of these items are listed below. (Note that the tire size, load index and speed rating for your vehicle may be different from this example.)

1. **P:** Indicates a tire, designated by the Tire and Rim Association (T&RA), that may be used for service on cars, SUVs, minivans and light trucks.

**Note:** If your tire size does not begin with a letter this may mean it is designated by either ETRTO (European Tire and Rim Technical Organization) or JATMA (Japan Tire Manufacturing Association).

2. **215:** Indicates the nominal width of the tire in millimeters from sidewall edge to sidewall edge. In general, the larger the number, the wider the tire.

3. **65:** Indicates the aspect ratio which gives the tire's ratio of height to width.

4. **R:** Indicates a “radial” type tire.

5. **15:** Indicates the wheel or rim diameter in inches. If you change your wheel size, you will have to purchase new tires to match the new wheel diameter.

6. **95:** Indicates the tire's load index. It is an index that relates to how much weight a tire can carry. You may find this information in your owner's guide. If not, contact a local tire dealer.

**Note:** You may not find this information on all tires because it is not required by federal law.

7. **H:** Indicates the tire's speed rating. The speed rating denotes the speed at which a tire is designed to be driven for extended periods of time under a standard condition of load and inflation pressure. The tires on your vehicle may operate at different conditions for load and inflation pressure. These speed ratings may need to be adjusted for the difference in conditions. The ratings range from 81 mph (130 km/h) to 186 mph (299 km/h). These ratings are listed in the following chart.

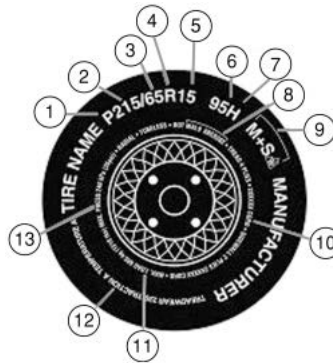

## Tires, Wheels and Loading

**Note:** You may not find this information on all tires because it is not required by federal law.

Letter rating	Speed rating - mph (km/h)
M	81 mph (130 km/h)
N	87 mph (140 km/h)
Q	99 mph (159 km/h)
R	106 mph (171 km/h)
S	112 mph (180 km/h)
T	118 mph (190 km/h)
U	124 mph (200 km/h)
H	130 mph (210 km/h)
V	149 mph (240 km/h)
W	168 mph (270 km/h)
Y	186 mph (299 km/h)

**Note:** For tires with a maximum speed capability over 149 mph (240 km/h), tire manufacturers sometimes use the letters ZR. For those with a maximum speed capability over 186 mph (299 km/h), tire manufacturers always use the letters ZR.

8. **U.S. DOT Tire Identification Number (TIN):** This begins with the letters "DOT" and indicates that the tire meets all federal standards. The next two numbers or letters are the plant code designating where it was manufactured, the next two are the tire size code and the last four numbers represent the week and year the tire was built. For example, the numbers 317 mean the 31st week of 1997. After 2000 the numbers go to four digits. For example, 2501 means the 25th week of 2001. The numbers in between are identification codes used for traceability. This information is used to contact customers if a tire defect requires a recall.

9. **M+S or M/S:** Mud and Snow, or

**AT:** All Terrain, or

**AS:** All Season.

10. **Tire Ply Composition and Material Used:** Indicates the number of plies or the number of layers of rubber-coated fabric in the tire tread and sidewall. Tire manufacturers also must indicate the ply materials in the tire and the sidewall, which include steel, nylon, polyester, and others.

11. **Maximum Load:** Indicates the maximum load in kilograms and pounds that can be carried by the tire. Refer to the Safety Compliance Certification Label, which is located on the B-Pillar or the edge of the driver's door, for the correct tire pressure for your vehicle.

## Tires, Wheels and Loading

### 12. Treadwear, Traction and Temperature Grades

- **Treadwear:** The treadwear grade is a comparative rating based on the wear rate of the tire when tested under controlled conditions on a specified government test course. For example, a tire graded 150 would wear one and one-half (1½) times as well on the government course as a tire graded 100.
- **Traction:** The traction grades, from highest to lowest are AA, A, B, and C. The grades represent the tire's ability to stop on wet pavement as measured under controlled conditions on specified government test surfaces of asphalt and concrete. A tire marked C may have poor traction performance.
- **Temperature:** The temperature grades are A (the highest), B and C, representing the tire's resistance to the generation of heat and its ability to dissipate heat when tested under controlled conditions on a specified indoor laboratory test wheel.

13. **Maximum Permissible Inflation Pressure:** Indicates the tire manufacturers' maximum permissible pressure and/or the pressure at which the maximum load can be carried by the tire. This pressure is normally higher than the manufacturer's recommended cold inflation pressure which can be found on the Safety Compliance Certification Label or Tire Label which is located on the B-Pillar or the edge of the driver's door. The cold inflation pressure should never be set lower than the recommended pressure on the vehicle label.

The tire suppliers may have additional markings, notes or warnings such as standard load, radial tubeless, etc.

## Tires, Wheels and Loading

### Additional information contained on the tire sidewall for “LT” type tires

“LT” type tires have some additional information beyond those of “P” type tires; these differences are described below.

**Note:** Tire Quality Grades do not apply to this type of tire.

1. **LT:** Indicates a tire, designated by the Tire and Rim Association (T&RA), that is intended for service on light trucks.

#### 2. **Load Range/Load Inflation**

**Limits:** Indicates the tire’s load-carrying capabilities and its inflation limits.

3. **Maximum Load Dual lb (kg) at psi (kPa) cold:** Indicates the maximum load and tire pressure when the tire is used as a dual; defined as four tires on the rear axle (a total of six or more tires on the vehicle).

4. **Maximum Load Single lb (kg) at psi (kPa) cold:** Indicates the maximum load and tire pressure when the tire is used as a single; defined as two tires (total) on the rear axle.

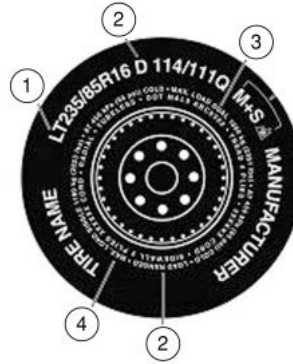

## Tires, Wheels and Loading

### Information on “T” type tires

“T” type tires have some additional information beyond those of “P” type tires; these differences are described below:

T145/80D16 is an example of a tire size.

**Note:** The temporary tire size for your vehicle may be different from this example. Tire Quality Grades do not apply to this type of tire.

1. **T:** Indicates a type of tire, designated by the Tire and Rim Association (T&RA), that is intended for temporary service on cars, SUVs, minivans and light trucks.

2. **145:** Indicates the nominal width of the tire in millimeters from sidewall edge to sidewall edge. In general, the larger the number, the wider the tire.

3. **80:** Indicates the aspect ratio which gives the tire’s ratio of height to width. Numbers of 70 or lower indicate a short sidewall.

4. **D:** Indicates a “diagonal” type tire.

**R:** Indicates a “radial” type tire.

5. **16:** Indicates the wheel or rim diameter in inches. If you change your wheel size, you will have to purchase new tires to match the new wheel diameter.

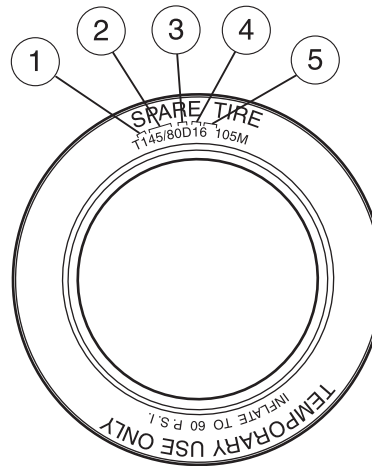

### Location of the tire label

You will find a Tire Label containing tire inflation pressure by tire size and other important information located on the B-Pillar or the edge of the driver’s door. Refer to the payload description and graphic in the *Vehicle loading – with and without a trailer* section.

## Tires, Wheels and Loading

### TIRE PRESSURE MONITORING SYSTEM (TPMS)

Each tire, including the spare (if provided), should be checked monthly when cold and inflated to the inflation pressure recommended by the vehicle manufacturer on the vehicle placard or tire inflation pressure label. (If your vehicle has tires of a different size than the size indicated on the vehicle placard or tire inflation pressure label, you should determine the proper tire inflation pressure for those tires.)

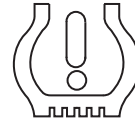

As an added safety feature, your vehicle has been equipped with a tire pressure monitoring system (TPMS) that illuminates a low tire pressure telltale when one or more of your tires is significantly under-inflated. Accordingly, when the low tire pressure telltale illuminates, you should stop and check your tires as soon as possible, and inflate them to the proper pressure. Driving on a significantly under-inflated tire causes the tire to overheat and can lead to tire failure. Under-inflation also reduces fuel efficiency and tire tread life, and may affect the vehicle's handling and stopping ability.

Please note that the TPMS is not a substitute for proper tire maintenance, and it is the driver's responsibility to maintain correct tire pressure, even if under-inflation has not reached the level to trigger illumination of the TPMS low tire pressure telltale.

Your vehicle has also been equipped with a TPMS malfunction indicator to indicate when the system is not operating properly. The TPMS malfunction indicator is combined with the low tire pressure telltale. When the system detects a malfunction, the telltale will flash for approximately one minute and then remain continuously illuminated. This sequence will continue upon subsequent vehicle start-ups as long as the malfunction exists.

When the malfunction indicator is illuminated, the system may not be able to detect or signal low tire pressure as intended. TPMS malfunctions may occur for a variety of reasons, including the installation of replacement or alternate tires or wheels on the vehicle that prevent the TPMS from functioning properly. Always check the TPMS malfunction telltale after replacing one or more tires or wheels on your vehicle to ensure that the replacement or alternate tires and wheels allow the TPMS to continue to function properly.

The tire pressure monitoring system complies with part 15 of the FCC rules and with RSS-210 of Industry Canada. Operation is subject to the

## Tires, Wheels and Loading

following two conditions: (1) This device may not cause harmful interference, and (2) This device must accept any interference received, including interference that may cause undesired operation.



**WARNING:** The tire pressure monitoring system is NOT a substitute for manually checking tire pressure. The tire pressure should be checked periodically (at least monthly) using a tire gauge, see *Inflating your tires* in this chapter. Failure to properly maintain your tire pressure could increase the risk of tire failure, loss of control, vehicle rollover and personal injury.

### Changing tires with a TPMS

**Each road tire is equipped with a tire pressure sensor fastened to the inside rim of the wheel. The pressure sensor is covered by the tire and is not visible unless the tire is removed. The pressure sensor is located opposite (180 degrees) from the valve stem. Care must be taken when changing the tire to avoid damaging the sensor.** It is recommended that you always have your tires serviced by an authorized dealer.

The tire pressure should be checked periodically (at least monthly) using an accurate tire gauge, refer to *Inflating your tires* in this chapter.

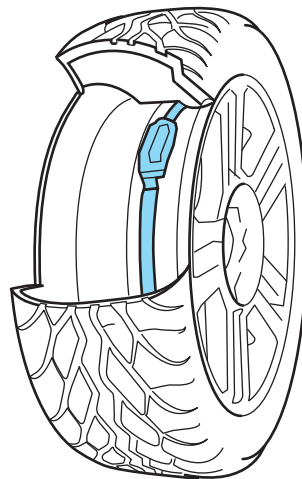

## Tires, Wheels and Loading

### **Understanding your tire pressure monitoring system (TPMS)**

The tire pressure monitoring system measures pressure in your four road tires and sends the tire pressure readings to your vehicle. The low tire pressure warning light will turn on if the tire pressure is significantly low. Once the light is illuminated, your tires are under-inflated and need to be inflated to the manufacturer's recommended tire pressure. Even if the light turns on and a short time later turns off, your tire pressure still needs to be checked. Visit [www.checkmytires.org](http://www.checkmytires.org) for additional information.

### ***When your temporary spare tire is installed***

When one of your road tires needs to be replaced with the temporary spare, the TPMS will continue to identify an issue to remind you that the damaged road wheel/tire needs to be repaired and put back on your vehicle. This includes the optional full-sized matching spare wheel and tire, as it is intended for temporary use only.

To restore the full functionality of the tire pressure monitoring system, have the damaged road wheel/tire repaired and remounted on your vehicle. For additional information, refer to *Changing tires with a TPMS* in this section.



## Tires, Wheels and Loading

### ***When you believe your system is not operating properly***

The main function of the tire pressure monitoring system is to warn you when your tires need air. It can also warn you in the event the system is no longer capable of functioning as intended. Please refer to the following chart for information concerning your tire pressure monitoring system:

Low tire pressure warning light	Possible cause	Customer action required
Solid warning light	Tire(s) under-inflated	1. Check your tire pressure to ensure tires are properly inflated; refer to <i>Inflating your tires</i> in this chapter. 2. After inflating your tires to the manufacturer's recommended inflation pressure as shown on the Tire Label (located on the edge of driver's door or the B-Pillar), the vehicle must be driven for at least two minutes over 20 mph (32 km/h) before the light will turn off.
	Spare tire in use	Your temporary spare tire is in use. (This includes the optional full-sized matching wheel and tire). Repair the damaged road wheel/tire and reinstall it on the vehicle to restore system functionality. For a description on how the system functions, refer to <i>When your temporary spare tire is installed</i> in this section.
	TPMS malfunction	If your tires are properly inflated and your spare tire is not in use and the light remains on, have the system inspected by your authorized dealer.

## Tires, Wheels and Loading

Low tire pressure warning light	Possible cause	Customer action required
Flashing warning light	Spare tire in use	Your temporary spare tire is in use. (This includes the optional full-sized matching wheel and tire). Repair the damaged road wheel and re-mount it on the vehicle to restore system functionality. For a description of how the system functions under these conditions, refer to <i>When your temporary spare tire is installed</i> in this section.
	TPMS malfunction	If your tires are properly inflated and your spare tire is not in use and the TPMS warning light still flashes, have the system inspected by your authorized dealer.

### **When inflating your tires**

When putting air into your tires (such as at a gas station or in your garage), the tire pressure monitoring system may not respond immediately to the air added to your tires.

It may take up to two minutes of driving over 20 mph (32 km/h) for the light to turn off after you have filled your tires to the recommended inflation pressure.

### **How temperature affects your tire pressure**

The tire pressure monitoring system (TPMS) monitors tire pressure in each pneumatic tire. While driving in a normal manner, a typical passenger tire inflation pressure may increase approximately 2 to 4 psi (14 to 28 kPa) from a cold start situation. If the vehicle is stationary overnight with the outside temperature significantly lower than the daytime temperature, the tire pressure may decrease approximately 3 psi (21 kPa) for a drop of 30°F (17°C) in ambient temperature. This lower pressure value may be detected by the TPMS as being significantly lower than the recommended inflation pressure and activate the TPMS warning light for low tire pressure. If the low tire pressure warning light is on, visually check each tire to verify that no tire is flat. (If one or more tires are flat, repair as necessary.) Check air pressure in the road tires. If any tire is under-inflated, carefully drive the vehicle to the nearest location where air can be added to the tires. Inflate all the tires to the recommended inflation pressure.

## Tires, Wheels and Loading

### SNOW TIRES AND CHAINS



**WARNING:** Snow tires must be the same size, load index, speed rating as those originally provided by Ford. Use of any tire or wheel not recommended by Ford can affect the safety and performance of your vehicle, which could result in an increased risk of loss of vehicle control, vehicle rollover, personal injury and death. Additionally, the use of non-recommended tires and wheels could cause steering, suspension, axle or transfer case/power transfer unit failure.

The tires on your vehicle have all-weather treads to provide traction in rain and snow. However, in some climates, you may need to use snow tires and chains. If you need to use chains, it is recommended that steel wheels (of the same size and specifications) be used, as chains may chip aluminum wheels.

**Note:** The suspension insulation and bumpers will help prevent vehicle damage. Do not remove these components from your vehicle when using snow tires and chains.

Follow these guidelines when using snow tires and chains:

- If possible, avoid fully loading your vehicle.
- Use only cable type chains offered by Ford Motor Company as an accessory or equivalent. Using SAE Class S or other conventional link type chains may cause damage to the vehicle's wheel house and/or body.
- Install chains securely, verifying that the chains do not touch any wiring, brake lines or fuel lines.
- Do not exceed 30 mph (48 km/h) with tire cables on your vehicle.
- Drive cautiously. If you hear the chains rub or bang against your vehicle, stop and retighten the chains. If this does not work, remove the chains to prevent damage to your vehicle.
- Remove the tire chains when they are no longer needed. Do not use tire chains on dry roads.

### VEHICLE LOADING – WITH AND WITHOUT A TRAILER

This section will guide you in the proper loading of your vehicle and/or trailer, to keep your loaded vehicle weight within its design rating capability, with or without a trailer. Properly loading your vehicle will provide maximum return of vehicle design performance. Before loading

## Tires, Wheels and Loading

your vehicle, familiarize yourself with the following terms for determining your vehicle's weight ratings, with or without a trailer, from the vehicle's Tire Label or Safety Compliance Certification Label:

**Base Curb Weight** – is the weight of the vehicle including a full tank of fuel and all standard equipment. It does not include passengers, cargo, or optional equipment.

**Vehicle Curb Weight** – is the weight of your new vehicle when you picked it up from your authorized dealer plus any aftermarket equipment.

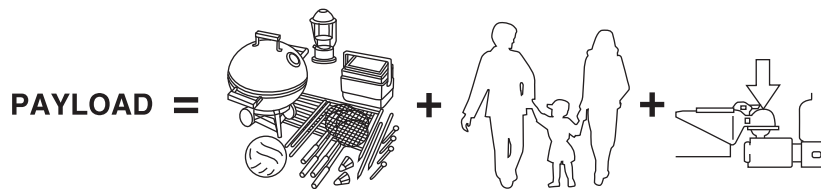

**Payload** – is the combined weight of cargo and passengers that the vehicle is carrying. The maximum payload for your vehicle can be found on the Tire Label on the B-Pillar or the edge of the driver's door (vehicles exported outside the US and Canada may not have a Tire Label). Look for **“THE COMBINED WEIGHT OF OCCUPANTS AND CARGO SHOULD NEVER EXCEED XXX kg OR XXX lb.”** for maximum payload. The payload listed on the Tire Label is the maximum payload for the vehicle as built by the assembly plant. If any aftermarket or authorized-dealer installed equipment has been installed on the vehicle, the weight of the equipment must be subtracted from the payload listed on the Tire Label in order to determine the new payload.

**⚠ WARNING:** The appropriate loading capacity of your vehicle can be limited either by volume capacity (how much space is available) or by payload capacity (how much weight the vehicle should carry). Once you have reached the maximum payload of your vehicle, do not add more cargo, even if there is space available. Overloading or improperly loading your vehicle can contribute to loss of vehicle control and vehicle rollover.

## Tires, Wheels and Loading

Example only:

TIRE AND LOADING INFORMATION				
SEATING CAPACITY		TOTAL 5	FRONT 2	REAR 3
The combined weight of occupants and cargo should never exceed : <b>XXX kg or XXX lbs.</b>				
TIRE	SIZE	COLD TIRE PRESSURE		SEE OWNERS MANUAL FOR ADDITIONAL INFORMATION
FRONT	LT225/75R 16.5E	200 KPA, 29 PSI		
REAR	LT225/75R 16.5E	200 KPA, 29 PSI		
SPARE	T145/80D16 P225/60R17	420 KPA, 60 PSI 200 KPA, 29 PSI		

TIRE AND LOADING INFORMATION				
RENSEIGNEMENTS SUR LES PNEUS ET LE CHARGEMENT				
SEATING CAPACITY		TOTAL 5	FRONT 2	REAR 3
NOMBRE DE PLACES		TOTAL 5	AVANT 2	ARRIERE 3
The combined weight of occupants and cargo should never exceed 492 kg or 1085 lbs. Le poids total des occupants et du chargement ne doit jamais dépasser 492 kg ou 1085 lb.				
TIRE PNEU	SIZE DIMENSIONS	COLD TIRE PRESSURE PRESSION DES PNEUS A FROID		SEE OWNER'S MANUAL FOR ADDITIONAL INFORMATION  VOIR LE MANUEL DE L'USAGER POUR PLUS DE RENSEIGNEMENTS
FRONT AVANT	P235/70R16	240 KPA, 35 PSI		
REAR ARRIERE	P235/70R16	240 KPA, 35 PSI		
SPARE DE SECOURS	T145/90R17	415 KPA, 60 PSI		

CARGO

=



+

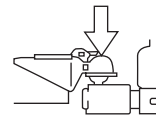

**Cargo Weight** – includes all weight added to the Base Curb Weight, including cargo and optional equipment. When towing, trailer tongue load weight is also part of cargo weight.

## Tires, Wheels and Loading

**GAW (Gross Axle Weight)** – is the total weight placed on each axle (front and rear) – including vehicle curb weight and all payload.

**GAWR (Gross Axle Weight Rating)** – is the maximum allowable weight that can be carried by a single axle (front or rear). **These numbers are shown on the Safety Compliance Certification Label located on the B-Pillar or the edge of the driver's door. The total load on each axle must never exceed its GAWR.**

**Note:** For trailer towing information refer to *Trailer towing* found in this chapter or the *RV and Trailer Towing Guide* provided by your authorized dealer.

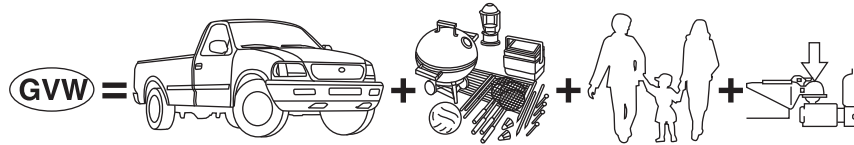

**GVW (Gross Vehicle Weight)** – is the Vehicle Curb Weight + cargo + passengers.

**GVWR (Gross Vehicle Weight Rating)** – is the maximum allowable weight of the fully loaded vehicle (including all options, equipment, passengers and cargo). **The GVWR is shown on the Safety Compliance Certification Label located on the B-Pillar or the edge of the driver's door. The GVW must never exceed the GVWR.**

## Tires, Wheels and Loading

- Example only:

**MFD. BY FORD MOTOR CO.**

DATE: XX/XX GVWR: XXXXXLB/ XXXXXKG  
 FRONT GAWR: XXXXL REAR GAWR: XXXXLB  
 XXXXKG WITH XXXXKG WITH  
 XXXX/XXXXXXX TIRES: XXXX/XXXXXXX TIRES  
 XXXX.XX RIMS: XXXX.XX RIMS  
 AT XXX kPa/XX PSI COLD AT XXX kPa/XX PSI COLD

THIS VEHICLE CONFORMS TO ALL APPLICABLE FEDERAL MOTOR  
 VEHICLE SAFETY STANDARDS IN EFFECT ON THE DATE OF  
 MANUFACTURE SHOWN ABOVE.

VIN: XXXXXXXXXXXXXXXXXXXX XXXXX  
 TYPE: XXX XXXXX



EXT PNT: XX RC: XX DSO:  
 WB INT TR TP/PS R AXLE TR SPR XXXXX  
 XXX XX X XX X XX XXX  
 XXXXXXXXXXXXXXX XXX XXXX-XXXXXX-XX

**MFD. BY FORD MOTOR CO.**

DATE: XX/XX GVWR/PNBV: XXXX LB/XXXXKG  
 FRONT GAWR/PNBE AV REAR GAWR/PNBE AR  
 XXXX/XXXXB XXXXKG/XXXXLB  
 WITH/AVEC TIRES/PNEUS  
 XXXX/XXXXX  
 XXXX/XXXXX  
 XXXXXX RIMS/JANTES XXXXXX

AT/A kPa/PSI/LPC XXX/XX COLD/A FROID XXX/XX  
 /JUMEELES

VIN: XXXXXXXXXXXXXXXXXXXX XXXXX  
 TYPE: XXX/XXXX COMPLIES: XXXX/XXX-XXX XXXXX  
 XXXXXX



EXT PNT: JJ RC: XX DSO:  
 WB INT TR TP/PS R AXLE TR SPR XXXXX  
 XXX XX X XX X XXXX XXX  
 XXXXXXXXXXXXXXX XXX XXXX-XXXXXX-XX



**WARNING:** Exceeding the Safety Compliance Certification Label vehicle weight rating limits could result in substandard vehicle handling or performance, engine, transmission and/or structural damage, serious damage to the vehicle, loss of control and personal injury.

## Tires, Wheels and Loading



**GCW (Gross Combined Weight)** – is the weight of the loaded vehicle (GVW) plus the weight of the fully loaded trailer.

**GCWR (Gross Combined Weight Rating)** – is the maximum allowable weight of the vehicle and the loaded trailer – including all cargo and passengers – that the vehicle can handle without risking damage. (Important: The towing vehicles' braking system is rated for operation at GVWR, not at GCWR. Separate functional brakes should be used for safe control of towed vehicles and for trailers where the GCW of the towing vehicle plus the trailer exceed the GVWR of the towing vehicle. **The GCW must never exceed the GCWR.**

**Maximum Loaded Trailer Weight** – is the highest possible weight of a fully loaded trailer the vehicle can tow. It assumes a vehicle with only mandatory options, no cargo (internal or external), a tongue load of 10–15% (conventional trailer), and driver only (150 lb. [68 kg]). **Consult your authorized dealer (or the *RV and Trailer Towing Guide* provided by your authorized dealer) for more detailed information.**



**WARNING:** Do not exceed the GVWR or the GAWR specified on the Safety Compliance Certification Label.



**WARNING:** Do not use replacement tires with lower load carrying capacities than the original tires because they may lower the vehicle's GVWR and GAWR limitations. Replacement tires with a higher limit than the original tires do not increase the GVWR and GAWR limitations.



**WARNING:** Exceeding any vehicle weight rating limitation could result in serious damage to the vehicle and/or personal injury.



## Tires, Wheels and Loading

### Steps for determining the correct load limit:

1. Locate the statement “The combined weight of occupants and cargo should never exceed XXX kg or XXX lbs.” on your vehicle’s placard.
2. Determine the combined weight of the driver and passengers that will be riding in your vehicle.
3. Subtract the combined weight of the driver and passengers from XXX kg or XXX lbs.
4. The resulting figure equals the available amount of cargo and luggage load capacity. For example, if the “XXX” amount equals 1,400 lbs. and there will be five 150 lb. passengers in your vehicle, the amount of available cargo and luggage load capacity is 650 lbs. ( $1400 - 750 (5 \times 150) = 650$  lb.). In metric units ( $635 - 340 (5 \times 68) = 295$  kg.)
5. Determine the combined weight of luggage and cargo being loaded on the vehicle. That weight may not safely exceed the available cargo and luggage load capacity calculated in Step 4.
6. If your vehicle will be towing a trailer, load from your trailer will be transferred to your vehicle. Consult this manual to determine how this reduces the available cargo and luggage load capacity of your vehicle.

The following gives you a few examples on how to calculate the available amount of cargo and luggage load capacity:

- Another example for your vehicle with 1,400 lb. (635 kg) of cargo and luggage capacity. You decide to go golfing. Is there enough load capacity to carry you, 4 of your friends and all the golf bags? You and four friends average 220 lb. (99 kg) each and the golf bags weigh approximately 30 lb. (13.5 kg) each. The calculation would be:  $1,400 - (5 \times 220) - (5 \times 30) = 1,400 - 1,100 - 150 = 150$  lb. Yes, you have enough load capacity in your vehicle to transport four friends and your golf bags. In metric units, the calculation would be:  $635 \text{ kg} - (5 \times 99 \text{ kg}) - (5 \times 13.5 \text{ kg}) = 635 - 495 - 67.5 = 72.5$  kg.
- A final example for your vehicle with 1,400 lb. (635 kg) of cargo and luggage capacity. You and one of your friends decide to pick up cement from the local home improvement store to finish that patio you have been planning for the past 2 years. Measuring the inside of the vehicle with the rear seat folded down, you have room for 12-100 lb. (45 kg) bags of cement. Do you have enough load capacity to transport the cement to your home? If you and your friend each weigh 220 lb. (99 kg), the calculation would be:  $1,400 - (2 \times 220) - (12 \times 100) = 1,400 - 440 - 1,200 = -240$  lb. No, you do not have enough cargo capacity to carry that much weight. In metric units, the

## Tires, Wheels and Loading

calculation would be:  $635 \text{ kg} - (2 \times 99 \text{ kg}) - (12 \times 45 \text{ kg}) = 635 - 198 - 540 = -103 \text{ kg}$ . You will need to reduce the load weight by at least 240 lb. (104 kg). If you remove 3-100 lb. (45 kg) cement bags, then the load calculation would be:

$1,400 - (2 \times 220) - (9 \times 100) = 1,400 - 440 - 900 = 60 \text{ lb}$ . Now you have the load capacity to transport the cement and your friend home. In metric units, the calculation would be:  $635 \text{ kg} - (2 \times 99 \text{ kg}) - (9 \times 45 \text{ kg}) = 635 - 198 - 405 = 32 \text{ kg}$ .

The above calculations also assume that the loads are positioned in your vehicle in a manner that does not overload the Front or the Rear Gross Axle Weight Rating specified for your vehicle on the Safety Compliance Certification Label found on the edge of the driver's door.

### TRAILER TOWING

Trailer towing puts additional loads on your vehicle's engine, transmission, axle, brakes, tires and suspension. For your safety and to maximize vehicle performance, be sure to use the proper equipment while towing.

**Note:** Long wheel based vehicles are NOT rated for towing.

Follow these guidelines to ensure safe towing:

- Do not tow a trailer until your vehicle has been driven at least 1,000 miles (1,600 km).
- Consult your local motor vehicle laws for towing a trailer.
- Refer to the instructions included with towing accessories for the proper installation and adjustment specifications.
- Thoroughly prepare your vehicle for towing. Refer to *Preparing to tow* in this chapter.
- Stay within your vehicle's load limits.
- Use extra caution when driving while trailer towing. Refer to *Driving while you tow* in this chapter.
- Service your vehicle more frequently if you tow a trailer. Refer to *Special operating conditions* in your scheduled maintenance.

Your loaded trailer should weigh no more than 1,500 lb (680 kg). The GCW of your vehicle and trailer should not exceed 6,600 lb (2,993 kg).

For load specification terms found on the label and instructions on calculating your vehicle's load, refer to *Vehicle loading - with and without a trailer* in this chapter. Remember to figure in the tongue load of your loaded vehicle when figuring the total weight.

## Tires, Wheels and Loading



**WARNING:** Do not exceed the GVWR or the GAWR specified on the certification label.



**WARNING:** Towing trailers beyond the maximum recommended gross trailer weight exceeds the limit of the vehicle and could result in engine damage, transmission damage, structural damage, loss of vehicle control, vehicle rollover and personal injury.

### Preparing to tow

Use the proper equipment for towing a trailer and make sure it is properly attached to your vehicle. Contact your authorized dealer or a reliable trailer dealer as soon as possible if you require assistance.

### Hitches

Do not use a hitch that clamps onto the vehicle's bumper; use a load-carrying hitch. You must distribute the load in your trailer so that 10–15% of the total weight of the trailer is on the tongue.

### Safety chains

Always connect the trailer's safety chains to the frame or hook retainers of the vehicle hitch. To connect the trailer's safety chains, cross the chains under the trailer tongue and allow slack for turning corners.

If you use a rental trailer, follow the instructions that the rental agency gives to you.

**Do not attach safety chains to the bumper.**

### Trailer brakes

Electric brakes and manual, automatic or surge-type trailer brakes are safe if installed properly and adjusted to the manufacturer's specifications. The trailer brakes must meet local and Federal regulations.



**WARNING:** Do not connect a trailer's hydraulic brake system directly to your vehicle's brake system. Your vehicle may not have enough braking power and your chances of having a collision greatly increase.

The braking system of the tow vehicle is rated for operation at the GVWR not GCWR.

## Tires, Wheels and Loading

### Trailer lamps

Trailer lamps are required on most towed vehicles. Make sure all running lights, brake lights, turn signals and hazard lights are working. Contact your authorized dealer or trailer rental agency for proper instructions and equipment for hooking-up trailer lamps.

### Driving while you tow

When towing a trailer:

- Do not drive faster than 70 mph (113 km/h) during the first 500 miles (800 km) of trailer towing and don't make full-throttle starts.
- Turn off the speed control. The speed control may shut off automatically when you are towing on long, steep grades.
- Use a lower gear to eliminate excessive shifting and assist in transmission cooling. For additional information, refer to *Automatic transmission operation* in the *Driving* chapter.
- Allow more distance for stopping with a trailer attached; anticipate stops and brake gradually.

### Trailer towing tips

- Practice turning, stopping and backing-up before starting on a trip to get the feel of the vehicle-trailer combination. When turning, make wider turns so the trailer wheels will clear curbs and other obstacles.
- To aid in engine/transmission cooling and A/C efficiency during hot weather while stopped in traffic, place the gearshift lever in P (Park).
- After you have traveled 50 miles (80 km), thoroughly check your hitch, electrical connections and trailer wheel lug nuts.
- If you are driving down a long or steep hill, shift to a lower gear. Do not apply the brakes continuously, as they may overheat and become less effective.
- If you will be towing a trailer frequently in hot weather, hilly conditions, at GCWR, or any combination of these factors, consider refilling your rear axle with synthetic gear lube if not already so equipped. Refer to the *Maintenance and Specifications* chapter for the lubricant specification. Remember that regardless of the rear axle lube used, do not tow a trailer for the first 1,000 miles (1,600 km) of a new vehicle, and that the first 500 miles (800 km) of towing be done at no faster than 70 mph (113 km/h) with no full throttle starts.
- Vehicles with trailers should not be parked on a grade. If you must park on a grade, place wheel chocks under the trailer's wheels.

## Tires, Wheels and Loading

### Launching or retrieving a boat

**Disconnect the wiring to the trailer before backing the trailer into the water. Reconnect the wiring to the trailer after the trailer is removed from the water.**

When backing down a ramp during boat launching or retrieval:

- Do not allow the static water level to rise above the bottom edge of the rear bumper.
- Do not allow waves to break higher than 6 in (15 cm) above the bottom edge of the rear bumper.

Exceeding these limits may allow water to enter vehicle components:

- Causing internal damage to the components.
- Affecting driveability, emissions and reliability.

Replace the rear axle lubricant any time the axle has been submerged in water. Rear axle lubricant quantities are not to be checked or changed unless a leak is suspected or repair required.

### RECREATIONAL TOWING

Follow these guidelines if you have a need for recreational (RV) towing. An example of recreational towing would be towing your vehicle behind a motor home.

In case of a roadside emergency with a disabled vehicle, please refer to *Wrecker towing* in the *Roadside Emergencies* chapter.

These guidelines are designed to prevent damage to your vehicle.

Do not tow your vehicle with any wheels on the ground, as vehicle or transmission damage may occur. It is recommended to tow your vehicle with all four (4) wheels off the ground such as when using a car-hauling trailer. Otherwise, no recreational towing is permitted.

## Driving

### STARTING

#### Positions of the ignition

1. Off— shuts off the engine and all accessories/locks the gearshift lever and allows key removal.
2. Accessory— allows the electrical accessories such as the radio to operate while the engine is not running.
3. On— all electrical circuits operational. Warning lights illuminated. Key position when driving.
4. Start— cranks the engine. Release the key as soon as the engine starts.

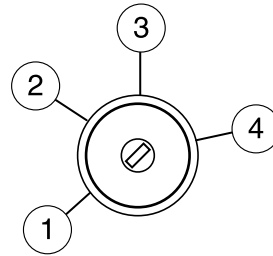

#### Preparing to start your vehicle

Engine starting is controlled by the powertrain control system. This system meets all Canadian interference-causing equipment standard requirements regulating the impulse electrical field strength of radio noise.

When starting a fuel-injected engine, avoid pressing the accelerator before or during starting. Only use the accelerator when you have difficulty starting the engine. For more information on starting the vehicle, refer to *Starting the engine* in this chapter.



**WARNING:** Extended idling at high engine speeds can produce very high temperatures in the engine and exhaust system, creating the risk of fire or other damage.



**WARNING:** Do not park, idle, or drive your vehicle in dry grass or other dry ground cover. The emission system heats up the engine compartment and exhaust system, which can start a fire.



**WARNING:** Do not start your vehicle in a closed garage or in other enclosed areas. Exhaust fumes can be toxic. Always open the garage door before you start the engine. See *Guarding against exhaust fumes* in this chapter for more instructions.

## Driving



**WARNING:** If you smell exhaust fumes inside your vehicle, have your dealer inspect your vehicle immediately. Do not drive if you smell exhaust fumes.

### **Important safety precautions**

A computer system controls the engine's idle revolutions per minute (RPM). When the engine starts, the idle RPM runs higher than normal in order to warm the engine. If the engine idle speed does not slow down automatically, have the vehicle checked. Do not allow the vehicle to idle for more than 10 minutes at the higher engine RPM.

Before starting the vehicle:

1. Make sure all vehicle occupants have buckled their safety belts. For more information on safety belts and their proper usage, refer to the *Seating and Safety Restraints* chapter.
2. Make sure the headlamps and vehicle accessories are off.
3. Make sure the gearshift is in P (Park).
4. Make sure the parking brake is set.

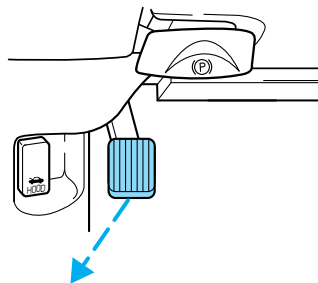

## Driving

5. Turn the key to 3 (on) without turning the key to 4 (start).

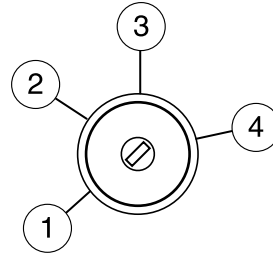

Some warning lights will briefly illuminate. See *Warning lights and chimes* in the *Instrument Cluster* chapter for more information regarding the warning lights.

### Starting the engine

1. Turn the key to 3 (on) without turning the key to 4 (start).

2. Turn the key to 4 (start), then release the key as soon as the engine starts. Excessive cranking could damage the starter.

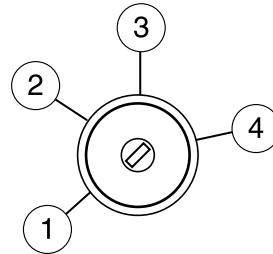

**Note:** If the engine does not start within five seconds on the first try, turn the key to OFF, wait 10 seconds and try again. If the engine still fails to start, press the accelerator to the floor and try again; this will allow the engine to crank with the fuel shut off in case the engine is flooded with fuel.

### Cold weather starting (flexible fuel vehicles only)

The starting characteristics of all grades of E<sub>85</sub> ethanol make it unsuitable for use when ambient temperatures fall below 0°F (-18°C). Consult your fuel distributor for the availability of winter grade ethanol. As the outside temperature approaches freezing, ethanol fuel distributors should supply winter grade ethanol (same as with unleaded gasoline). If summer grade ethanol is used in cold weather conditions, 0°F to 32°F (-18°C to 0°C), you may experience increased cranking times, rough idle or hesitation until the engine has warmed up.



## Driving

You may experience a decrease in peak performance when the engine is cold when operating on E<sub>85</sub> ethanol.

Do not crank the engine for more than 10 seconds at a time as starter damage may occur. If the engine fails to start, turn the key to off and wait 30 seconds before trying again.

Do not use starting fluid such as ether in the air intake system. Such fluid could cause immediate explosive damage to the engine and possible personal injury.

If you should experience cold weather starting problems on E<sub>85</sub> ethanol, and neither an alternative brand of E<sub>85</sub> ethanol nor an engine block heater is available, the addition of unleaded gasoline to your tank will improve cold starting performance. Your vehicle is designed to operate on E<sub>85</sub> ethanol alone, unleaded gasoline alone, or any mixture of the two.

See *Choosing the right fuel* in the *Maintenance and Specifications* chapter for more information on ethanol.

### **If the engine fails to start using the preceding instructions (flexible fuel vehicles only)**

1. Press and hold down the accelerator 1/3 to 1/2 way to floor, then crank the engine.
2. When the engine starts, release the key, then gradually release the accelerator pedal as the engine speeds up. If the engine still fails to start, repeat Step 1.

### **Guarding against exhaust fumes**

Carbon monoxide is present in exhaust fumes. Take precautions to avoid its dangerous effects.



**WARNING:** If you smell exhaust fumes inside your vehicle, have your dealer inspect your vehicle immediately. Do not drive if you smell exhaust fumes.

### **Important ventilating information**

If the engine is idling while the vehicle is stopped for a long period of time, open the windows at least 1 inch (2.5 cm) or adjust the heating or air conditioning to bring in fresh air.

## Driving

### ENGINE BLOCK HEATER (IF EQUIPPED)

An engine block heater warms the engine coolant which aids in starting and allows the heater/defroster system to respond quickly. If your vehicle is equipped with this system, your equipment includes a heater element which is installed in your engine block and a wire harness which allows the user to connect the system to a grounded 120 volt A/C electrical source. The block heater system is most effective when outdoor temperatures reach below 0°F (-18°C).

For flexible fuel vehicles, if operating with E85 ethanol, an engine block heater must be used if ambient temperature is below 0°F (-18°C).

See *Cold weather starting* earlier in this chapter for more information on starting with ethanol.



**WARNING:** Failure to follow engine block heater instructions could result in property damage or physical injury.



**WARNING:** To reduce the risk of electrical shock, do not use your heater with ungrounded electrical systems or two-pronged (cheater) adapters.

Prior to using the engine block heater, follow these recommendations for proper and safe operation:

- For your safety, use an outdoor extension cord that is product certified by Underwriter's Laboratory (UL) or Canadian Standards Association (CSA). Use only an extension cord that can be used outdoors, in cold temperatures, and is clearly marked "Suitable for Use with Outdoor Appliances." Never use an indoor extension cord outdoors; it could result in an electric shock or fire hazard.
- Use a 16 gauge outdoor extension cord, minimum.
- Use as short an extension cord as possible.
- Do not use multiple extension cords. Instead, use one extension cord which is long enough to reach from the engine block heater cord to the outlet without stretching.
- Make certain that the extension cord is in excellent condition (not patched or spliced). Store your extension cord indoors at temperatures above 32°F (0°C). Outdoor conditions can deteriorate extension cords over a period of time.

## Driving

- To reduce the risk of electrical shock, do not use your heater with ungrounded electrical systems or two pronged (cheater) adapters. Also ensure that the block heater, especially the cord, is in good condition before use.
- Make sure that when in operation, the extension cord plug /engine block heater cord plug connection is free and clear of water in order to prevent possible shock or fire.
- Be sure that areas where the vehicle is parked are clean and clear of all combustibles such as petroleum products, dust, rags, paper and similar items.
- Be sure that the engine block heater, heater cord and extension cord are solidly connected. A poor connection can cause the cord to become very hot and may result in an electrical shock or fire. Be sure to check for heat anywhere in the electrical hookup once the system has been operating for approximately a half hour.
- Finally, have the engine block heater system checked during your fall tune-up to be sure it's in good working order.

### **How to use the engine block heater**

Ensure the receptacle terminals are clean and dry prior to use. To clean them, use a dry cloth.

Depending on the type of factory installed equipment, your engine block heater system may consume anywhere between 400 watts or 1000 watts of power per hour. Your factory installed block heater system does not have a thermostat; however, maximum temperature is attained after approximately three hours of operation. Block heater operation longer than three hours will not improve system performance and will unnecessarily use additional electricity.

Make sure system is unplugged and properly stowed before driving the vehicle. While not in use, make sure the protective cover seals the prongs of the engine block heater cord plug.

### **BRAKES**

Your service brakes are self-adjusting. Refer to the *scheduled maintenance information* for scheduled maintenance.

Occasional brake noise is normal and often does not indicate a performance concern with the vehicle's brake system. In normal operation, automotive brake systems may emit occasional or intermittent squeal or groan noises when the brakes are applied. Such noises are usually heard during the first few brake applications in the morning;

## Driving

however, they may be heard at any time while braking and can be aggravated by environmental conditions such as cold, heat, moisture, road dust, salt or mud. If a “metal-to-metal,” “continuous grinding” or “continuous squeal” sound is present while braking, the brake linings may be worn-out and should be inspected by an authorized dealer.

Refer to *Brake system warning light* in the *Warning lights and chimes* section of the *Instrument Cluster* chapter for information.

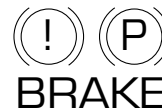

**WARNING:** If you are driving down a long or steep hill, shift to a lower gear. Do not apply your brakes continuously, as they may overheat and become less effective.

Under normal operating conditions, brake dust may accumulate on the wheels. Some brake dust is inevitable as brakes wear and does not contribute to brake noise. The use of modern friction materials with emphasis on improved performance and environmental considerations can lead to more dust than in the past. Brake dust can be cleaned by weekly washing with soapy water and a soft sponge. Heavier deposits can be removed with Motorcraft® Wheel and Tire Cleaner. See the *Cleaning* chapter for more information.

### Anti-lock brake system (ABS)

This vehicle is equipped with an anti-lock braking system (ABS). A noise from the hydraulic pump motor and pulsation in the pedal may be observed during ABS braking events. Pedal pulsation coupled with noise while braking under panic conditions or on loose gravel, bumps, wet or snowy roads is normal and indicates proper functioning of the vehicle's anti-lock brake system. If the vehicle has continuous vibration or shudder in the steering wheel while braking, the vehicle should be inspected by an authorized dealer.

The ABS operates by detecting the onset of wheel lockup during brake applications and compensates for this tendency. The wheels are prevented from locking even when the brakes are firmly applied. The accompanying illustration depicts the advantage of an ABS equipped vehicle (on bottom) to a non-ABS equipped vehicle (on top) during hard braking with loss of front braking traction.

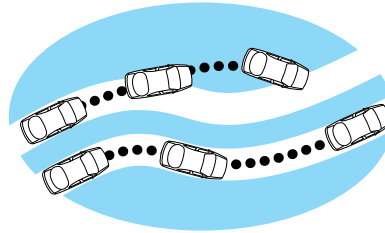

### **Using ABS**

- In an emergency or when maximum efficiency from the four-wheel ABS is required, apply continuous force on the brake. The four wheel ABS will be activated immediately, thus allowing you to retain steering control of your vehicle and, providing there is sufficient space, will enable you to avoid obstacles and bring the vehicle to a controlled stop.
- The anti-lock system does not reduce stopping distance. Always leave enough room between your vehicle and the vehicle in front of you to stop.
- We recommend that you familiarize yourself with this braking technique. However, avoid taking any unnecessary risks.

### **ABS warning lamp**

The ABS warning lamp in the instrument cluster momentarily illuminates when the ignition is turned on. If the light does not illuminate momentarily at start up, remains on or continues to flash, the ABS needs to be serviced.

With the ABS light on, the anti-lock brake system is disabled and normal braking is still effective unless the brake warning light also remains illuminated with parking brake released. If your brake warning lamp illuminates, have your vehicle serviced immediately.



## Driving

### Parking brake

Apply the parking brake whenever the vehicle is parked.

To set the parking brake:

1. Move the gearshift to P (Park).
2. Press pedal downward.

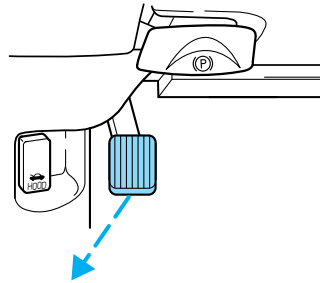

The BRAKE warning lamp in the instrument cluster illuminates and remains illuminated (when the ignition is turned on) until the parking brake is fully released.

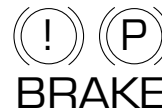

**WARNING:** Always set the parking brake fully and make sure the gearshift is latched in P (Park). Turn the ignition to the off position and remove the key whenever you leave your vehicle.

The parking brake is not recommended to stop a moving vehicle. However, if the normal brakes fail, the parking brake can be used to stop your vehicle in an emergency. Since the parking brake applies only the rear brakes, the vehicle's stopping distance will increase greatly and the handling of your vehicle will be adversely affected.

Pull the lever to release the parking brake.

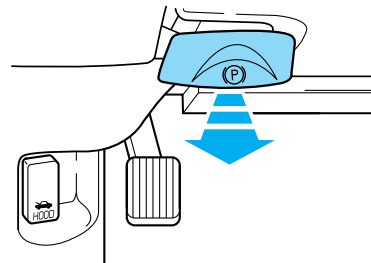

### TRACTION CONTROL (IF EQUIPPED)

The traction control system helps you maintain the stability and steerability of your vehicle, especially on slippery road surfaces such as snow- or ice-covered roads and gravel roads. The system will allow your vehicle to make better use of available traction in these conditions.

During traction control operation, the traction control active light will illuminate, you may hear an electric motor type of sound coming from the engine compartment, and the



engine may not “rev-up” when you press farther on the accelerator. This is normal system behavior and should be no reason for concern.



**WARNING:** Aggressive driving in any road conditions can cause you to lose control of your vehicle increasing the risk of severe personal injury or property damage. The occurrence of a traction control event is an indication that at least some of the tires have exceeded their ability to grip the road; this may lead to an increased risk of loss of vehicle control, vehicle rollover, personal injury and death. If you experience a severe road event, SLOW DOWN.

The traction control switch is located on the instrument panel. The traction control system will automatically turn on every time the ignition is turned off and on. When disabled, OFF will be illuminated on the switch. The traction control system will automatically turn on every time the ignition is turned to off and on.

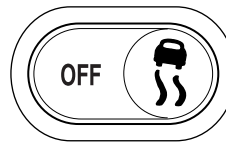

If you should become stuck in snow or ice or on a very slippery road surface, try switching the traction control system off. Switching the traction control system off may allow excess wheel spin to “dig” the vehicle out and enable a successful “rocking” maneuver. When the traction control system is off, an indicator light will illuminate and will remain on until the system is turned back on or the ignition is turned off and on. Remember to switch the traction control system back on once the vehicle is no longer stuck.

If a system fault is detected, the traction control active light will illuminate, the traction control button will not turn the system on or off and your vehicle should be serviced by an authorized dealer.

## Driving

### STEERING

To help prevent damage to the power steering system, never hold the steering wheel at its furthest turning points (until it stops) for more than a few seconds when the engine is running.

It is also important to maintain a proper power steering fluid level in the power steering fluid reservoir:

- Do not operate the vehicle with a low power steering pump fluid level. See *Power steering fluid* in the *Maintenance and Specifications* chapter.
- Some noise is normal during operation. If the noise is excessive, check for low power steering pump fluid level before seeking service by your authorized dealer.
- Heavy or uneven steering efforts may be caused by low power steering pump fluid level. Check for low power steering pump fluid level before seeking service by your authorized dealer.
- Do not fill the power steering pump reservoir above the maximum level, as this may result in leaks from the reservoir. See *Power steering fluid* in the *Maintenance and Specifications* chapter.

If the power steering system breaks down (or if the engine is off), you can steer the vehicle manually, but it takes more effort.

If the steering wanders or pulls, check for:

- an improperly inflated tire
- uneven tire wear
- loose or worn suspension components
- loose or worn steering components
- improper steering alignment

### AIR SUSPENSION SYSTEM (IF EQUIPPED)

The air suspension system is designed to improve ride, handling and general vehicle performance during:

- Certain road conditions
- Steering maneuvers
- Braking
- Accelerations

This system keeps the rear of your vehicle at a constant level by automatically adding air or releasing air from the springs.



## Driving

If you exceed the load limit, the rear air suspension may not operate.

The air suspension shut-off switch is located on the left side of the trunk. If this switch is in the off position, the rear air suspension will not operate.



**WARNING:** On vehicles equipped with air suspension, turn off the air suspension switch prior to jacking, hoisting or towing your vehicle.



Normal vehicle operation does not require any action by the driver.

### TRACTION-LOK™ AXLE (IF EQUIPPED)

This axle provides added traction on slippery surfaces, particularly when one wheel is on a poor traction surface. Under normal conditions, the Traction-Lok™ axle functions like a standard rear axle.

Extended use of other than the manufacturer's specified size tires on a Traction-Lok™ rear axle could result in a permanent reduction in effectiveness. This loss of effectiveness does not affect normal driving and should not be noticeable to the driver.

### BRAKE-SHIFT INTERLOCK

This vehicle is equipped with a brake-shift interlock feature that prevents the gearshift lever from being moved from P (Park) when the ignition is in the on position unless brake pedal is pressed.

If you cannot move the gearshift lever out of P (Park) with ignition in the on position and the brake pedal pressed, it is possible that a fuse has blown or the vehicle's brake lamps are not operating properly. Refer to *Fuses and relays* in the *Roadside Emergencies* chapter.

If the fuse is not blown, perform the following procedure:

1. Apply the parking brake, turn the ignition to the accessory position.

## Driving

2. Locate the access plug on the underside of the steering column cover.
3. Remove the access plug using a flat head screwdriver. Insert the screwdriver into the access hole nearest the steering wheel. Then press and hold the override button using a flat head screwdriver. Apply the brake pedal and shift the transmission into N (Neutral) while continuing to press the override button.
4. Reinstall the access plug cover, start the vehicle and release the parking brake.

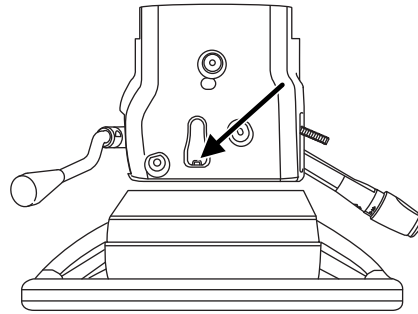

**WARNING:** Do not drive your vehicle until you verify that the brakelamps are working.



**WARNING:** Always set the parking brake fully and make sure the gearshift is latched in P (Park). Turn the ignition to the off position and remove the key whenever you leave your vehicle.



**WARNING:** If the parking brake is fully released, but the brake warning lamp remains illuminated, the brakes may not be working properly. See your authorized dealer.

## AUTOMATIC TRANSMISSION OPERATION

### Understanding the gearshift positions of the 4-speed automatic transmission

#### P (Park)

This position locks the transmission and prevents the rear wheels from turning.

To put your vehicle in gear:

- Start the engine
- Press the brake pedal



## Driving

- Move the gearshift lever into the desired gear

To put your vehicle in P (Park):

- Come to a complete stop
- Move the gearshift lever and securely latch it in P (Park)

 **WARNING:** Always set the parking brake fully and make sure the gearshift is latched in P (Park). Turn the ignition to the off position and remove the key whenever you leave your vehicle.

### R (Reverse)

With the gearshift lever in R (Reverse), the vehicle will move backward. Always come to a complete stop before shifting into and out of R (Reverse).

### N (Neutral)

With the gearshift lever in N (Neutral), the vehicle can be started and is free to roll. Hold the brake pedal down while in this position.

### D (Overdrive)

The normal driving position for the best fuel economy. Transmission operates in gears one through four.

Overdrive can be deactivated by pressing the transmission control switch on the gearshift lever.

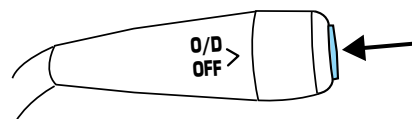

The transmission control indicator light (TCIL) will illuminate on the instrument cluster.

O/D  
OFF

### Drive (not shown)

Drive is activated when the transmission control switch is pressed.

- This position allows for all forward gears except overdrive.
- O/D OFF lamp is illuminated.
- Provides engine braking.
- Use when driving conditions cause excessive shifting from O/D to other gears. Examples: hilly terrain, heavy loads, trailer towing and when engine braking is required.

## Driving

- To return to O/D (overdrive mode), press the transmission control switch. The O/D OFF lamp will not be illuminated.
- O/D (Overdrive) is automatically returned each time the key is turned off.

### 2 (Second)

This position allows for second gear only.

- Provides engine braking.
- Use to start-up on slippery roads.
- To return to **D** (Overdrive), move the gearshift lever into the **D** (Overdrive) position.
- Selecting 2 (Second) at higher speeds will cause the transmission to downshift to second gear at the appropriate vehicle speed.

### 1 (First)

- Provides maximum engine braking.
- Allows upshifts by moving gearshift lever.
- Will not downshift into 1 (First) at high speeds; allows for 1 (First) when vehicle reaches slower speeds.

### Forced downshifts

- Allowed in **D** (Overdrive) or Drive.
- Press the accelerator to the floor.
- Allows transmission to select an appropriate gear.

### ***If your vehicle gets stuck in mud or snow***

If your vehicle gets stuck in mud or snow, it may be rocked out by shifting between forward and reverse gears, stopping between shifts in a steady pattern. Press lightly on the accelerator in each gear.

**Do not rock the vehicle if the engine is not at normal operating temperature or damage to the transmission may occur.**

**Do not rock the vehicle for more than a minute or damage to the transmission and tires may occur, or the engine may overheat.**

### DRIVING THROUGH WATER

If driving through deep or standing water is unavoidable, proceed very slowly. Never drive through water that is higher than the bottom of the wheel rims (for cars) or the bottom of the hubs (for trucks).

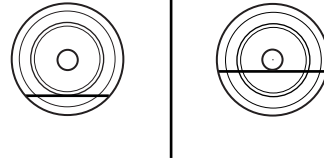

When driving through water, traction or brake capability may be limited. Also, water may enter your engine's air intake and severely damage your engine or your vehicle may stall. **Driving through deep water where the transmission vent tube is submerged may allow water into the transmission and cause internal transmission damage.**

**Once through the water, always dry the brakes by moving your vehicle slowly while applying light pressure on the brake pedal.** Wet brakes do not stop the vehicle as quickly as dry brakes.

## Roadside Emergencies

### ROADSIDE ASSISTANCE

#### Vehicles sold in the U.S. : Getting roadside assistance

To fully assist you should you have a vehicle concern, Ford Motor Company offers a complimentary roadside assistance program. This program is separate from the New Vehicle Limited Warranty. The service is available:

- 24-hours, seven days a week
- for the coverage period listed on the Roadside Assistance Card included in your Owner Guide portfolio.

Roadside assistance will cover:

- a flat tire change with a good spare (except vehicles that have been supplied with a tire inflation kit)
- battery jump start
- lock-out assistance (key replacement cost is the customer's responsibility)
- fuel delivery – Independent Service Contractors, if not prohibited by state, local or municipal law shall deliver up to 2.0 gallons (7.5L) of gasoline or 5.0 gallons (18.9L) of diesel fuel to a disabled vehicle. Fuel delivery service is limited to two no-charge occurrences within a 12-month period.
- winch out – available within 100 feet (30.5 meters) of a paved or county maintained road, no recoveries.
- towing – Ford and Lincoln eligible vehicles towed to an authorized dealer within 35 miles (56 km) of the disablement location or to the nearest authorized dealer. If a member requests to be towed to an authorized dealer more than 35 miles (56 km) from the disablement location, the member shall be responsible for any mileage costs in excess of 35 miles (56 km).

Trailers shall be covered up to \$200 if the disabled eligible vehicle requires service at the nearest authorized dealer. If the trailer is disabled, but the towing vehicle is operational, the trailer does not qualify for any roadside services.

#### Vehicles sold in the U.S. : Using roadside assistance

Complete the roadside assistance identification card and place it in your wallet for quick reference. In the United States, this card is found in the Owner Guide portfolio in the glove compartment. In Canada, the card is found in the *Warranty Guide* in the glove compartment.

## Roadside Emergencies

U.S. Ford vehicle customers who require Roadside Assistance, call 1-800-241-3673.

If you need to arrange roadside assistance for yourself, Ford Motor Company will reimburse a reasonable amount for towing to the nearest dealership within 35 miles (56 km). To obtain reimbursement information, U.S. Ford vehicle customers call 1-800-241-3673. Customers will be asked to submit their original receipts.

### Vehicles sold in Canada : Getting roadside assistance

Canadian customers who require roadside assistance, call 1-800-665-2006.

### Vehicles sold in Canada : Using roadside assistance

Complete the roadside assistance identification card and place it in your wallet for quick reference. In Canada, the card is found in the Warranty Guide in the glove box.

Canadian Roadside coverage and benefits may differ from the U.S. coverage. Please refer to your Warranty Guide or visit our website at [www.ford.ca](http://www.ford.ca) for information on Canadian services and benefits.

Canadian customers who need to obtain roadside information, call 1-800-665-2006 or visit our website at [www.ford.ca](http://www.ford.ca).

### HAZARD FLASHER CONTROL

The hazard flasher is located on the steering column, just behind the steering wheel. The hazard flashers will operate when the ignition is in any position or if the key is not in the ignition.

- Press the flasher control and all front and rear direction signals will flash.
- Press the flasher control again to turn them off.

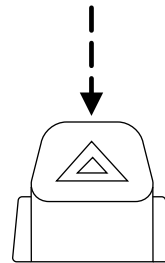

Use it when your vehicle is disabled and is creating a safety hazard for other motorists.

**Note:** With extended use, the flasher may run down your battery.

## Roadside Emergencies

### FUEL PUMP SHUT-OFF SWITCH FUEL RESET

The fuel pump shut-off switch is a device intended to stop the electric fuel pump when your vehicle has been involved in a substantial jolt.

After a collision, if the engine cranks but does not start, the fuel pump shut-off switch may have been activated.

The fuel pump shut-off switch is located on the left side of the trunk behind the left rear tail light and the trunk liner.

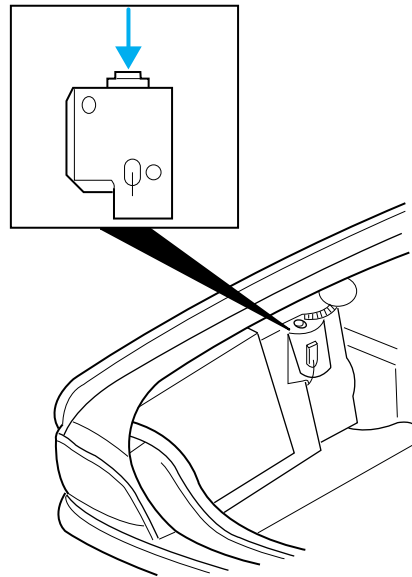

Use the following procedure to reset the fuel pump shut-off switch.

1. Turn the ignition to the off position.
2. Check the fuel system for leaks.
3. If no fuel leak is apparent, reset the fuel pump shut-off switch by pressing the reset button.
4. Turn the ignition to the on position. Pause for a few seconds and return the key to the off position.
5. Make a further check for leaks in the fuel system.



## Roadside Emergencies

### FUSES AND RELAYS

#### Fuses

If electrical components in the vehicle are not working, a fuse may have blown. Blown fuses are identified by a broken wire within the fuse. Check the appropriate fuses before replacing any electrical components.

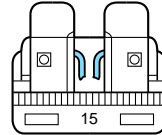

**Note:** Always replace a fuse with one that has the specified amperage rating. Using a fuse with a higher amperage rating can cause severe wire damage and could start a fire.

#### Standard fuse amperage rating and color

COLOR					
Fuse rating	Mini fuses	Standard fuses	Maxi fuses	Cartridge maxi fuses	Fuse link cartridge
2A	Grey	Grey	—	—	—
3A	Violet	Violet	—	—	—
4A	Pink	Pink	—	—	—
5A	Tan	Tan	—	—	—
7.5A	Brown	Brown	—	—	—
10A	Red	Red	—	—	—
15A	Blue	Blue	—	—	—
20A	Yellow	Yellow	Yellow	Blue	Blue
25A	Natural	Natural	—	Natural	Natural
30A	Green	Green	Green	Pink	Pink
40A	—	—	Orange	Green	Green
50A	—	—	Red	Red	Red
60A	—	—	Blue	Yellow	Yellow
70A	—	—	Tan	—	Brown
80A	—	—	Natural	Black	Black

#### Passenger compartment fuse panel

The fuse panel is located below and to the left of the steering wheel by the brake pedal. Remove the panel cover to access the fuses.

## Roadside Emergencies

To remove a fuse use the fuse puller tool provided on the fuse panel cover.

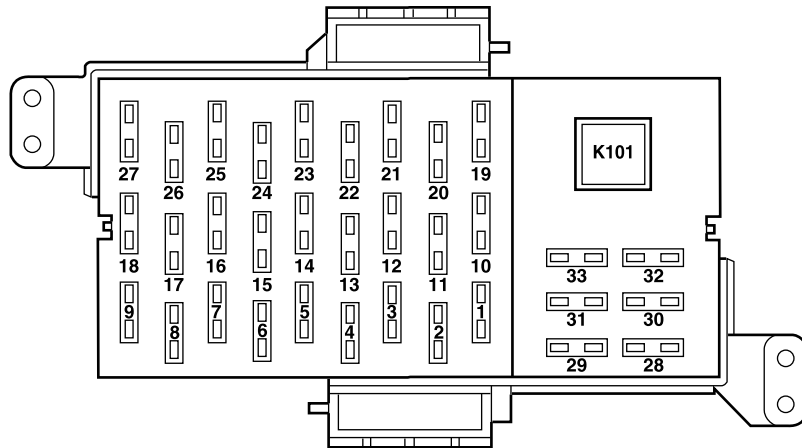

The fuses are coded as follows.

Fuse/Relay Location	Fuse Amp Rating	Protected Circuits
1	10A	Ignition (START) - Starter relay coil, DTRS
2	7.5A	Power mirrors, Mirror switch, Keypad switch, Decklid switch, Adjustable pedal switch, Driver's door module, Cluster
3	5A	Ignition (START) - Audio mute, Police power distribution box (PDB) (Police vehicles only)
4	10A	Lighting control module (LCM) (switch illumination), Autolamp sensor
5	7.5A	Ignition (ON/ACC) - LCM
6	7.5A	LCM
7	10A	Ignition (ON/ACC) - Wiper module

## Roadside Emergencies

Fuse/Relay Location	Fuse Amp Rating	Protected Circuits
8	10A	Electronic automatic temperature control (EATC) module (vehicles equipped with EATC only)
9	7.5A	Ignition (ON/ACC) - Door lock switch illumination, Heated seat switch illumination, Radio, Antenna, Electrochromatic mirror, Window relay coil, Decklid relay coil and Police ON/ACC relay coil (Police vehicles only)
10	15A	Hazards (non-Police vehicles only)
	20A	Hazards (Police vehicles only)
11	15A	Ignition (ON) - Turn signals
12	15A	Audio
13	10A	Ignition (ON) - rear air suspension module (RASM), Cluster
14	15A	Taxi, Adjustable pedals
15	10A	Ignition (ON) - EATC module, A/C mode switch (vehicles equipped with manual A/C only), A/C blower relay coil
16	20A	On-board diagnostics (OBD II)
17	10A	Ignition (ON) - A/C mode switch (vehicles equipped with manual A/C), Blend door, Heated seat modules
18	15A	LCM (interior lighting)
19	10A	LCM (Left-hand low beam)
20	10A	Ignition (ON/START) - Back-up lamps, Anti-lock brake system (ABS)
21	10A	LCM (Right-hand low beam)

## Roadside Emergencies

Fuse/Relay Location	Fuse Amp Rating	Protected Circuits
22	10A	Ignition (ON/START) - Restraint control module (RCM), Occupant classification sensor (OCS), Passenger airbag deactivation indicator (PADI)
23	15A	Multi-function switch (Flash-to-pass), LCM (High beams)
24	10A	Ignition (ON/START) - Passive anti-theft system (PATS) module, Powertrain control module (PCM) relay coil, Fuel relay coil, Ignition relay coil
25	15A	LCM (Park lamps, corner lamps, license lamps)
26	10A	Ignition (ON/START) - Cluster, LCM, Overdrive cancel switch, Traction control switch
27	—	Not used
28	7.5A	Brake signal, LCM (brake transmission shift interlock), ABS
29	2A	Hazard in (Police vehicles only)
30	2A	Battery saver (Police vehicles only)
31	5A	Key in (LCM)
32	2A	Hazard out (Police vehicles only)
33	10A	Fire suppression module (if equipped) (Police vehicles only)
K101	Full ISO relay	Window relay, Decklid (Police vehicles only)

### Power distribution box

The power distribution box is located in the engine compartment. The power distribution box contains high-current fuses that protect your vehicle's main electrical systems from overloads.

## Roadside Emergencies



**WARNING:** Always disconnect the battery before servicing high current fuses.



**WARNING:** To reduce risk of electrical shock, always replace the cover to the power distribution box before reconnecting the battery or refilling fluid reservoirs.

If the battery has been disconnected and reconnected, refer to the *Battery* section of the *Maintenance and Specifications* chapter.

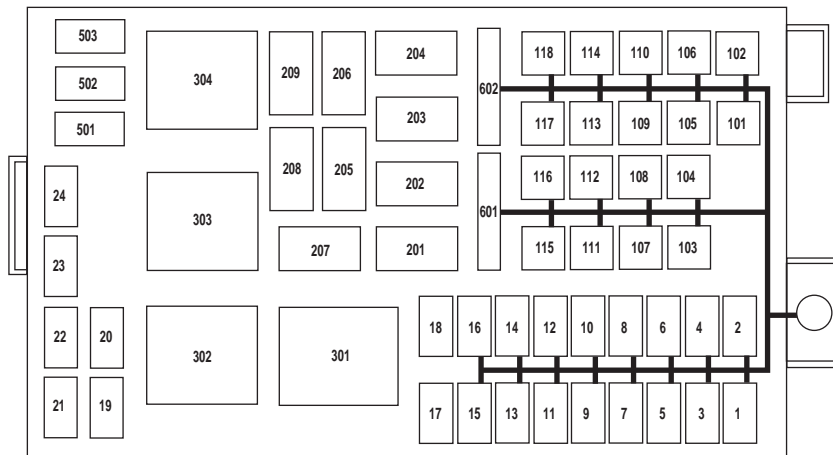

The high-current fuses are coded as follows.

Fuse/Relay Location	Fuse Amp Rating	Protected Circuits
1	30A*	Ignition switch
2	20A*	Spot lights (Police vehicles only)
3	10A*	Powertrain control module (PCM) – keep alive power, Canister vent
4	20A*	Fuel relay feed
5	10A*	Rear air suspension module (RASM)

## Roadside Emergencies

Fuse/Relay Location	Fuse Amp Rating	Protected Circuits
6	15A*	Alternator regulator
7	30A*	PCM relay feed
8	20A*	Driver's door module (DDM)
9	15A*	Ignition coil relay feed
10	20A*	Horn relay feed
11	15A*	A/C clutch relay feed
12	20A*	Audio (Subwoofer)
	25A*	Police tray lamps (Police vehicles only)
13	20A*	Instrument panel power point
14	20A*	Stop lamp switch
15	15A*	Fog lamps (Grand Marquis only), Police accessory battery feed 1 (Police vehicles only)
16	20A*	Heated seats (Grand Marquis only), Police accessory battery feed 2 (Police vehicles only)
17	10A*	Commercial R/A (Crown Victoria only)
18	10A*	Commercial R/A (Crown Victoria only)
19	15A*	Injectors
20	15A*	PCM
21	15A*	Powertrain loads and sensors
22	20A*	Police power distribution box (PDB) outputs (Police vehicles only)
23	20A*	Police PDB outputs (Police vehicles only)
24	10A*	Heated mirrors, Rear defrost indicator
101	40A**	Blower relay feed

## Roadside Emergencies

Fuse/Relay Location	Fuse Amp Rating	Protected Circuits
102	50A**	Cooling fan
103	50A**	Instrument panel (I/P) fuse box feed #1, I/P fuses 10, 12, 14, 16 and 18
104	50A**	Instrument panel (I/P) fuse box feed #2, I/P fuses 2, 4, 6, 8, 19, 21, 23 and 25
105	30A**	Starter relay feed
106	40A**	Anti-lock brake system (ABS) module (Pump)
107	40A**	Rear defroster relay feed
108	20A**	Cigar lighter (Non-police vehicles only), Police accessory battery feed 3 (Police vehicles only)
109	20A**	ABS module (Valves)
110	30A**	Wiper module
111	50A**	Police PDB or Police accessory battery feed (Police vehicles only)
112	30A**	Air suspension compressor (non-Police vehicles only)
	40A**	Police PDB relay feed (Police vehicles only)
113	50A**	Police light bar or Police right-hand kick panel accessory battery feed (Police vehicles only)
114	50A**	Police PDB or Police accessory battery feed (Police vehicles only)
115	50A**	Rear power point or Police right-hand kick panel accessory battery feed (Police vehicles only)
116	50A**	Police accessory and PDB (Police vehicles only)

## Roadside Emergencies

Fuse/Relay Location	Fuse Amp Rating	Protected Circuits
117	50A**	Police accessory and PDB (Police vehicles only)
118	50A**	Rear power point or Police right-hand kick panel accessory battery feed (Police vehicles only)
201	½ ISO relay	A/C clutch
202	—	Not used
203	½ ISO relay	Ignition coil
204	½ ISO relay	PCM
205	½ ISO relay	Fog lamps (Grand Marquis only)
206	½ ISO relay	Fuel
207	—	Not used
208	—	Not used
209	½ ISO relay	Horn
301	Full ISO relay	Starter
302	Full ISO relay	Air compressor (non-Police vehicles only), RUN/ACC relay (Police vehicles only)
303	Full ISO relay	Blower
304	Full ISO relay	Rear defrost relay
501	—	Not used
502	Diode	PCM
503	—	Not used
601	20A Circuit breaker	Power seats, Lumbar, Decklid (Police vehicles only)
602	20A Circuit breaker	RUN/ACC relay feed – Windows, Decklid (Police vehicles only)

\* Mini fuse \*\* Cartridge fuse

### Relays

Relays are located in the power distribution box and should be replaced by an authorized dealer.



## Roadside Emergencies

### CHANGING THE TIRES

If you get a flat tire while driving, do not apply the brake heavily. Instead, gradually decrease your speed. Hold the steering wheel firmly and slowly move to a safe place on the side of the road.

**Note:** The tire pressure monitoring system (TPMS) indicator light will illuminate when the spare tire is in use. To restore the full functionality of the monitoring system, all road wheels equipped with tire pressure monitoring sensors must be mounted on the vehicle.

Have a flat serviced by an authorized dealer in order to prevent damage to the TPMS sensors, refer to *Tire pressure monitoring system (TPMS)* in the *Tires, Wheels and Loading* chapter. Replace the spare tire with a road tire as soon as possible. During repairing or replacing of the flat tire, have the authorized dealer inspect the TPMS sensor for damage.



**WARNING:** The use of tire sealants may damage your tire pressure monitoring system (TPMS) and should not be used. However, if you must use a sealant, the TPMS sensor and valve stem on the wheel must be replaced by an authorized Ford dealer.



**WARNING:** Refer to *Tire pressure monitoring system (TPMS)* in the *Tires, Wheels and Loading* chapter for important information. If the tire pressure monitor sensor becomes damaged, it will no longer function.

### Dissimilar spare tire/wheel information



**WARNING:** Failure to follow these guidelines could result in an increased risk of loss of vehicle control, injury or death.

If you have a dissimilar spare tire/wheel, then it is intended for temporary use only. This means that if you need to use it, you should replace it as soon as possible with a road tire/wheel that is the same size and type as the road tires and wheels that were originally provided by Ford. If the dissimilar spare tire or wheel is damaged, it should be replaced rather than repaired.

## Roadside Emergencies

A dissimilar spare tire/wheel is defined as a spare tire and/or wheel that is different in brand, size or appearance from the road tires and wheels and can be one of three types:

1. **T-type mini-spare:** This spare tire begins with the letter “T” for tire size and may have “Temporary Use Only” molded in the sidewall
2. **Full-size dissimilar spare with label on wheel:** This spare tire has a label on the wheel that states: “THIS TIRE AND WHEEL FOR TEMPORARY USE ONLY”

When driving with one of the dissimilar spare tires listed above, **do not:**

- Exceed 50 mph (80 km/h)
- Load the vehicle beyond maximum vehicle load rating listed on the Safety Compliance Label
- Tow a trailer
- Use snow chains on the end of the vehicle with the dissimilar spare tire
- Use more than one dissimilar spare tire at a time
- Use commercial car washing equipment
- Try to repair the dissimilar spare tire

Use of one of the dissimilar spare tires listed above at any one wheel location can lead to impairment of the following:

- Handling, stability and braking performance
- Comfort and noise
- Ground clearance and parking at curbs
- Winter weather driving capability
- Wet weather driving capability
- All-wheel driving capability (if applicable)

### 3. **Full-size dissimilar spare without label on wheel**

When driving with the full-size dissimilar spare tire/wheel, **do not:**

- Exceed 70 mph (113 km/h)
- Use more than one dissimilar spare tire/wheel at a time
- Use commercial car washing equipment
- Use snow chains on the end of the vehicle with the dissimilar spare tire/wheel

## Roadside Emergencies

The usage of a full-size dissimilar spare tire/wheel can lead to impairment of the following:

- Handling, stability and braking performance
- Comfort and noise
- Ground clearance and parking at curbs
- Winter weather driving capability
- Wet weather driving capability
- All-wheel driving capability (if applicable)
- Load leveling adjustment (if applicable)

When driving with the full-size dissimilar spare tire/wheel additional caution should be given to:

- Towing a trailer
- Driving vehicles equipped with a camper body
- Driving vehicles with a load on the cargo rack

Drive cautiously when using a full-size dissimilar spare tire/wheel and seek service as soon as possible.

### Full-size matching spare tire/wheel information

This spare tire/wheel will match the road tire/wheel. When driving with the full size matching spare tire/wheel, do not exceed 70 mph (113 km/h). It is intended for temporary use only. This means if you need to use it, you should replace it as soon as possible.

### Stopping and securing the vehicle

1. Park on a level surface, set the parking brake and activate hazard flashers.
2. Place gearshift lever in P (Park) and turn engine off.

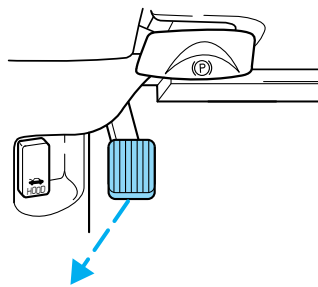

## Roadside Emergencies

### Removing the spare tire and jack

1. Remove the spare tire and the jack. The jack could be located:

- A — behind the mini spare tire or
- B — behind the full size spare tire

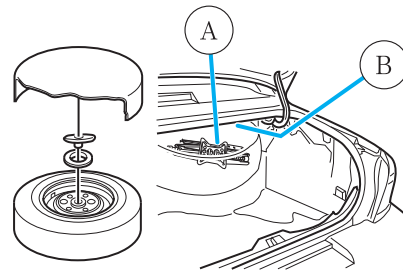

**WARNING:** On vehicles equipped with air suspension, turn off the air suspension switch prior to jacking, hoisting or towing your vehicle.

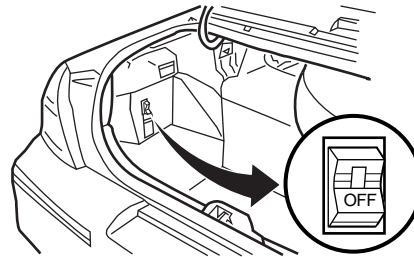

Refer to *Air suspension system* in the *Driving* chapter.

2. Remove the lug wrench from the jack. Rotate the lug wrench socket out from the handle.

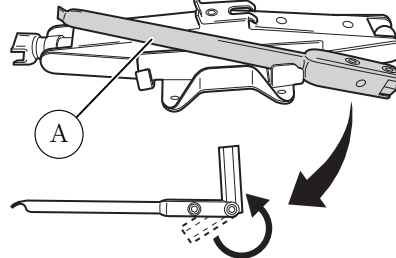

## Roadside Emergencies

### Tire change procedure

**!** **WARNING:** When one of the front wheels is off the ground, the transmission alone will not prevent the vehicle from moving or slipping off the jack, even if the vehicle is in P (Park).

**!** **WARNING:** To help prevent the vehicle from moving when you change a tire, be sure the parking brake is set, then block (in both directions) the wheel that is diagonally opposite (other side and end of the vehicle) to the tire being changed.

**!** **WARNING:** If the vehicle slips off the jack, you or someone else could be seriously injured.

**!** **WARNING:** Do not attempt to change a tire on the side of the vehicle close to moving traffic. Pull far enough off the road to avoid the danger of being hit when operating the jack or changing the wheel.

**Note:** Passengers should not remain in the vehicle when the vehicle is being jacked.

1. Block the diagonally opposite wheel.

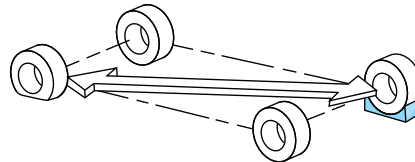

2. Remove any wheel trim. Insert the tapered end of the lug nut wrench behind wheel covers or hubcaps and twist off.

3. Loosen each wheel metal lug nut one-half turn counterclockwise but do not remove them until the wheel is raised off the ground.

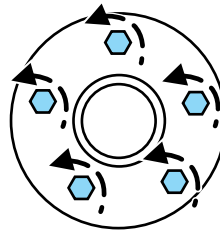

## Roadside Emergencies

**STOP** Before placing the jack under the vehicle, NOTE the jack location markings:

### JACK LOCATION

The jack location markings can be found **on the lower outer edge of the body**.

- Locate the jack locator mark (B) on the body (C) near the tire you are changing, then place the jack (D) **under the frame (A) of the vehicle** aligning it with the mark (B).
- Position the jack according to the following guides and turn the jack handle clockwise until the wheel is completely off the ground.

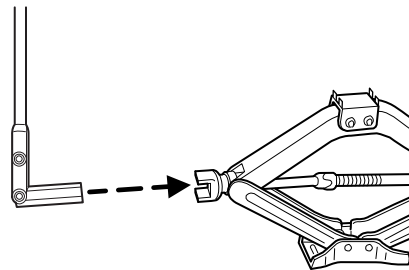
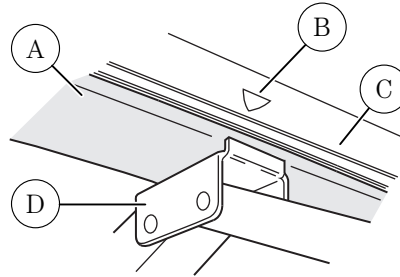

**WARNING:** To lessen risk of personal injury, do not put any part of your body under the vehicle while changing a tire. Do not start the engine when your vehicle is on the jack. The jack is **ONLY** meant for changing the tire.

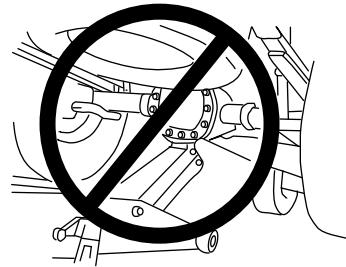

- **Never use the rear differential as a jacking point.**
4. Remove the metal lug nuts with the lug wrench.
  5. Replace the flat tire/wheel assembly with the spare tire/wheel assembly, making sure the valve stem is facing outward. Reinstall lug nuts until the wheel is snug against the hub. Do not fully tighten the lug nuts until the wheel has been lowered.

## Roadside Emergencies

6. Lower the vehicle by turning the jack handle counterclockwise.
7. Remove the jack and fully tighten the lug nuts in the order shown. Refer to *Wheel lug nut torque specifications* later in this chapter for the proper lug nut torque specification.
8. Install any wheel covers, ornaments or hub caps. Make sure they are snapped in place.
9. Put flat tire, jack and lug wrench away.
10. Turn on the air suspension switch (if equipped).

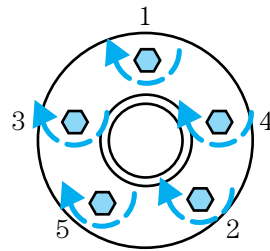

### WHEEL LUG NUT TORQUE SPECIFICATIONS

Retighten the lug nuts to the specified torque within 100 miles (160 km) after any wheel disturbance (tire rotation, changing a flat tire, wheel removal, etc.).

Bolt size	Wheel lug nut torque*	
	ft-lb	N•m
1/2 x 20	100	135

\* Torque specifications are for nut and bolt threads free of dirt and rust. Use only Ford recommended replacement fasteners.



**WARNING:** When a wheel is installed, always remove any corrosion, dirt or foreign materials present on the mounting surfaces of the wheel or the surface of the wheel hub, brake drum or brake disc that contacts the wheel. Ensure that any fasteners that attach the rotor to the hub are secured so they do not interfere with the mounting surfaces of the wheel. Installing wheels without correct metal-to-metal contact at the wheel mounting surfaces can cause the wheel nuts to loosen and the wheel to come off while the vehicle is in motion, resulting in loss of control.

## Roadside Emergencies

**Note:** Inspect the wheel pilot hole prior to installation. If there is visible corrosion in wheel pilot hole, remove loose particles by wiping with clean rag and apply grease. Apply grease only to the wheel pilot hole surface by smearing a “dime” (1 square cm) sized glob of grease around the wheel pilot surface (1) with end of finger. **DO NOT** apply grease to lugnut/stud holes or wheel-to-brake surfaces.

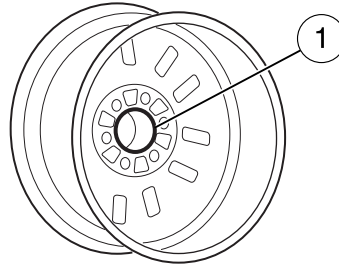

### JUMP STARTING

 **WARNING:** The gases around the battery can explode if exposed to flames, sparks, or lit cigarettes. An explosion could result in injury or vehicle damage.

 **WARNING:** Batteries contain sulfuric acid which can burn skin, eyes and clothing, if contacted.

**Do not attempt to push-start your automatic transmission vehicle. Automatic transmissions do not have push-start capability. Attempting to push-start a vehicle with an automatic transmission may cause transmission damage.**

### Preparing your vehicle

When the battery is disconnected or a new battery is installed, the automatic transmission must relearn its shift strategy. As a result, the transmission may have firm and/or soft shifts. This operation is considered normal and will not affect function or durability of the transmission. Over time, the adaptive learning process will fully update transmission operation.

1. **Use only a 12-volt supply to start your vehicle.**
2. Do not disconnect the battery of the disabled vehicle as this could damage the vehicle's electrical system.
3. Park the booster vehicle close to the hood of the disabled vehicle making sure the two vehicles **do not** touch. Set the parking brake on both vehicles and stay clear of the engine cooling fan and other moving parts.



## Roadside Emergencies

4. Check all battery terminals and remove any excessive corrosion before you attach the battery cables. Ensure that vent caps are tight and level.
5. Turn the heater fan on in both vehicles to protect from any electrical surges. Turn all other accessories off.

### Connecting the jumper cables

**Note:** In the illustration, the vehicle on the bottom is used to designate the assisting (boosting) battery.

1. Connect the positive (+) jumper cable to the positive (+) terminal of the discharged battery.
2. Connect the other end of the positive (+) cable to the positive (+) terminal of the assisting battery.
3. Connect the negative (-) cable to the negative (-) terminal of the assisting battery.
4. Make the final connection of the negative (-) cable to an exposed metal part of the stalled vehicle's engine, away from the battery and the carburetor/fuel injection system.

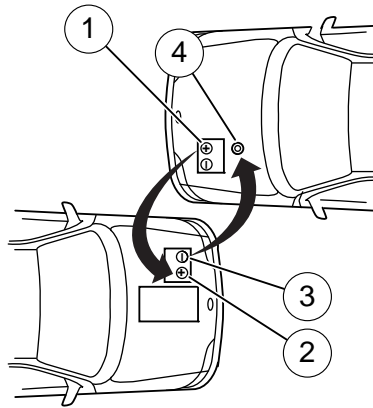

**Note:** Do not attach the negative (-) cable to fuel lines, engine rocker covers, the intake manifold or electrical components as grounding points.



**WARNING:** Do not connect the end of the second cable to the negative (-) terminal of the battery to be jumped. A spark may cause an explosion of the gases that surround the battery.

Ensure that the cables are clear of fan blades, belts, moving parts of both engines, or any fuel delivery system parts.

## Roadside Emergencies

### Jump starting

1. Start the engine of the booster vehicle and run the engine at moderately increased speed.
2. Start the engine of the disabled vehicle.
3. Once the disabled vehicle has been started, run both engines for an additional three minutes before disconnecting the jumper cables.

### Removing the jumper cables

Remove the jumper cables in the reverse order that they were connected.

**Note:** In the illustration, the vehicle on the bottom is used to designate the assisting (boosting) battery.

1. Remove the jumper cable from the ground metal surface.
2. Remove the jumper cable on the negative (-) terminal of the booster vehicle's battery.
3. Remove the jumper cable from the positive (+) terminal of the booster vehicle's battery.
4. Remove the jumper cable from the positive (+) terminal of the disabled vehicle's battery.

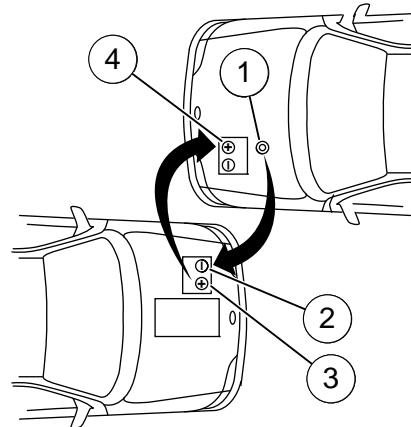

After the disabled vehicle has been started and the jumper cables removed, allow it to idle for several minutes so the engine computer can relearn its idle conditions.

## Roadside Emergencies

### WRECKER TOWING

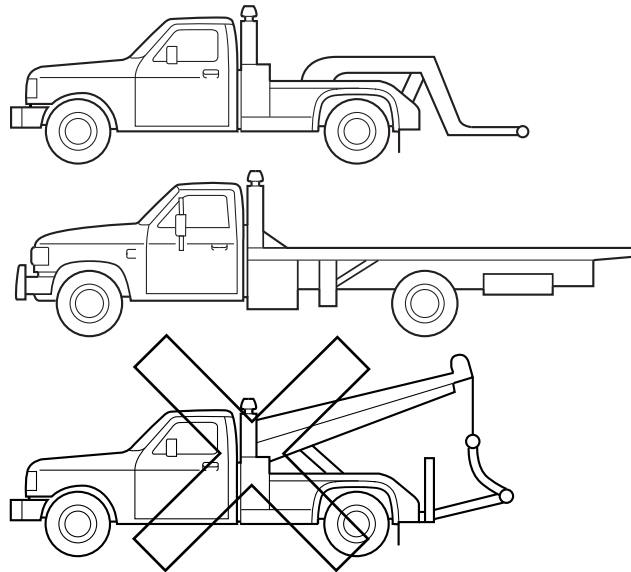

If you need to have your vehicle towed, contact a professional towing service or, if you are a member of a roadside assistance program, your roadside assistance service provider.

It is recommended that your vehicle be towed with a wheel lift or flatbed equipment. Do not tow with a slingbelt. Ford Motor Company has not approved a slingbelt towing procedure.

If equipped with an air suspension system, the air suspension control in the luggage compartment must be turned to the off position before your vehicle can be towed.

**If the vehicle is towed by other means or incorrectly, vehicle damage may occur.**

Ford Motor Company produces a towing manual for all authorized tow truck operators. Have your tow truck operator refer to this manual for proper hook-up and towing procedures for your vehicle.

## Roadside Emergencies

### Emergency towing

In case of a roadside emergency with a disabled vehicle (without access to wheel dollies, car hauling trailer, or flatbed transport vehicle) your vehicle (regardless of transmission powertrain configuration) can be flat towed (all wheels on the ground) under the following conditions:

- Vehicle is facing forward so that it is being towed in a forward direction.
- Place the transmission in N (Neutral). Refer to *Brake-shift interlock* in the *Driving* chapter for specific instructions if you cannot move the gear shift lever into N (Neutral).
- Maximum speed is not to exceed 35 mph (56 km/h).
- Maximum distance is 50 miles (80 km).

## Customer Assistance

### GETTING THE SERVICES YOU NEED

Warranty repairs to your vehicle must be performed by an authorized dealer. While any authorized dealer handling your vehicle line will provide warranty service, we recommend you return to your selling authorized dealer who wants to ensure your continued satisfaction.

Please note that certain warranty repairs require special training and/or equipment, so not all authorized dealers are authorized to perform all warranty repairs. This means that, depending on the warranty repair needed, you may have to take your vehicle to another authorized dealer.

A reasonable time must be allowed to perform a repair after taking your vehicle to the authorized dealer. Repairs will be made using Ford or Motorcraft® parts, or remanufactured or other parts that are authorized by Ford.

### Away from home

If you are away from home when your vehicle needs service, contact the Ford Customer Relationship Center or use the online resources listed below to find the nearest authorized dealer.

In the United States:

#### **Mailing address**

Ford Motor Company  
Customer Relationship Center  
P.O. Box 6248  
Dearborn, MI 48121

#### **Telephone**

1-800-392-3673 (FORD)  
(TDD for the hearing impaired: 1-800-232-5952)

#### **Online**

Additional information and resources are available online at [www.genuineservice.com](http://www.genuineservice.com).

These are some of the items that can be found online:

- U.S. dealer locator by Dealer Name, City/State, or Zip Code
- Owner Guides
- Maintenance Schedules
- Recalls
- Ford Extended Service Plans
- Ford Genuine Accessories
- Service specials and promotions.

<https://www.MyCarManual.com>

213

## Customer Assistance

In Canada:

**Mailing address (Ford vehicles)**

Customer Relationship Centre  
Ford Motor Company of Canada, Limited  
P.O. Box 2000  
Oakville, Ontario L6J 5E4

**Telephone**

1-800-565-3673 (FORD)

**Online**

[www.ford.ca](http://www.ford.ca)

**Mailing address (Lincoln vehicles)**

Lincoln Centre  
Ford Motor Company of Canada, Limited  
P.O. Box 2000  
Oakville, Ontario L6J 5E4

**Telephone**

1-800-387-9333

**Online**

[www.lincolncanada.com](http://www.lincolncanada.com)

**Additional assistance**

If you have questions or concerns, or are unsatisfied with the service you are receiving, follow these steps:

1. Contact your Sales Representative or Service Advisor at your selling/servicing authorized dealer.
2. If your inquiry or concern remains unresolved, contact the Sales Manager, Service Manager or Customer Relations Manager.
3. If you require assistance or clarification on Ford Motor Company policies, please contact the Ford Customer Relationship Center

In order to help you serve you better, please have the following information available when contacting a Customer Relationship Center:

- Vehicle Identification Number (VIN)
- Your telephone number (home and business)
- The name of the authorized dealer and city where located
- The vehicle's current odometer reading

In some states, you must directly notify Ford in writing before pursuing remedies under your state's warranty laws. Ford is also allowed a final repair attempt in some states.

214

<https://www.MyCarManual.com>

## Customer Assistance

In the United States, a warranty dispute must be submitted to the BBB AUTO LINE before taking action under the Magnuson-Moss Warranty Act, or to the extent allowed by state law, before pursuing replacement or repurchase remedies provided by certain state laws. This dispute handling procedure is not required prior to enforcing state created rights or other rights which are independent of the Magnuson-Moss Warranty Act or state replacement or repurchase laws.

### IN CALIFORNIA (U.S. ONLY)

California Civil Code Section 1793.2(d) requires that, if a manufacturer or its representative is unable to repair a motor vehicle to conform to the vehicle's applicable express warranty after a reasonable number of attempts, the manufacturer shall be required to either replace the vehicle with one substantially identical or repurchase the vehicle and reimburse the buyer in an amount equal to the actual price paid or payable by the consumer (less a reasonable allowance for consumer use). The consumer has the right to choose whether to receive a refund or replacement vehicle.

California Civil Code Section 1793.22(b) presumes that the manufacturer has had a reasonable number of attempts to conform the vehicle to its applicable express warranties if, within the first 18 months of ownership of a new vehicle or the first 18,000 miles (29,000 km), whichever occurs first:

1. Two or more repair attempts are made on the same non-conformity likely to cause death or serious bodily injury OR
2. Four or more repair attempts are made on the same nonconformity (a defect or condition that substantially impairs the use, value or safety of the vehicle) OR
3. The vehicle is out of service for repair of nonconformities for a total of more than 30 calendar days (not necessarily all at one time)

In the case of 1 or 2 above, the consumer must also notify the manufacturer of the need for the repair of the nonconformity at the following address:

Ford Motor Company  
16800 Executive Plaza Drive  
Mail Drop 3NE-B  
Dearborn, MI 48126

## Customer Assistance

You are required to submit your warranty dispute to BBB AUTO LINE before asserting in court any rights or remedies conferred by California Civil Code Section 1793.22(b). You are also required to use BBB AUTO LINE before exercising rights or seeking remedies created by the Federal Magnuson-Moss Warranty Act, 15 U.S.C. sec. 2301 et seq. If you choose to seek redress by pursuing rights and remedies not created by California Civil Code Section 1793.22(b) or the Magnuson-Moss Warranty Act, resort to BBB AUTO LINE is not required by those statutes.

### **THE BETTER BUSINESS BUREAU (BBB) AUTO LINE PROGRAM (U.S. ONLY)**

Your satisfaction is important to Ford Motor Company and to your dealer. If a warranty concern has not been resolved using the three-step procedure outlined earlier in this chapter in the *Getting the services you need* section, you may be eligible to participate in the BBB AUTO LINE program.

The BBB AUTO LINE program consists of two parts – mediation and arbitration. During mediation, a representative of the BBB will contact both you and Ford Motor Company to explore options for settlement of the claim. If an agreement is not reached during mediation or you do not want to participate in mediation, and if your claim is eligible, you may participate in the arbitration process. An arbitration hearing will be scheduled so that you can present your case in an informal setting before an impartial person. The arbitrator will consider the testimony provided and make a decision after the hearing.

Disputes submitted to the BBB AUTO LINE program are usually decided within forty days after you file your claim with the BBB. You are not bound by the decision, and may reject the decision and proceed to court where all findings of the BBB Auto Line dispute, and decision, are admissible in the court action. Should you choose to accept the BBB AUTO LINE decision, Ford is then bound by the decision, and must comply with the decision within 30 days of receipt of your acceptance letter.

BBB AUTO LINE Application: Using the information provided below, please call or write to request a program application. You will be asked for your name and address, general information about your new vehicle, information about your warranty concerns, and any steps you have already taken to try to resolve them. A Customer Claim Form will be mailed that will need to be completed, signed and returned to the BBB along with proof of ownership. Upon receipt, the BBB will review the claim for eligibility under the Program Summary Guidelines.



## Customer Assistance

**You can get more information by calling BBB AUTO LINE at 1-800-955-5100, or writing to:**

**BBB AUTO LINE  
4200 Wilson Boulevard, Suite 800  
Arlington, Virginia 22203-1833**

BBB AUTO LINE applications can also be requested by calling the Ford Motor Company Customer Relationship Center at 1-800-392-3673.

**Note:** Ford Motor Company reserves the right to change eligibility limitations, modify procedures, or to discontinue this process at any time without notice and without obligation.

### **UTILIZING THE MEDIATION/ARBITRATION PROGRAM (CANADA ONLY)**

For vehicles delivered to authorized Canadian dealers. In those cases where you continue to feel that the efforts by Ford of Canada and the authorized dealer to resolve a factory-related vehicle service concern have been unsatisfactory, Ford of Canada participates in an impartial third party mediation/arbitration program administered by the Canadian Motor Vehicle Arbitration Plan (CAMVAP).

The CAMVAP program is a straight forward and relatively speedy alternative to resolve a disagreement when all other efforts to produce a settlement have failed. This procedure is without cost to you and is designed to eliminate the need for lengthy and expensive legal proceedings.

In the CAMVAP program, impartial third-party arbitrators conduct hearings at mutually convenient times and places in an informal environment. These impartial arbitrators review the positions of the parties, make decisions and, when appropriate, render awards to resolve disputes. CAMVAP decisions are fast, fair, and final as the arbitrator's award is binding on both you and Ford of Canada.

CAMVAP services are available in all Canadian territories and provinces. For more information, without charge or obligation, call your CAMVAP Provincial Administrator directly at 1-800-207-0685 or visit [www.camvap.ca](http://www.camvap.ca).

### **GETTING ASSISTANCE OUTSIDE THE U.S. AND CANADA**

Before exporting your vehicle to a foreign country, contact the appropriate foreign embassy or consulate. These officials can inform you of local vehicle registration regulations and where to find unleaded fuel.

If you cannot find unleaded fuel or can only get fuel with an anti-knock index lower than is recommended for your vehicle, contact a regional office or owner relations/customer relationship office.

<https://www.MyCarManual.com>

217

## Customer Assistance

The use of leaded fuel in your vehicle without proper conversion may damage the effectiveness of your emission control system and may cause engine knocking or serious engine damage. Ford Motor Company/Ford of Canada is not responsible for any damage caused by use of improper fuel. Using leaded fuel may also result in difficulty importing your vehicle back into the U.S.

If your vehicle must be serviced while you are traveling or living in Asia-Pacific Region, Sub-Saharan Africa, U.S. Virgin Islands, Central America, the Caribbean, and Israel, contact the nearest authorized dealer. If the authorized dealer cannot help you, contact:

FORD MOTOR COMPANY  
FORD EXPORT OPERATIONS & GLOBAL INITIATIVES  
1555 Fairlane Drive  
Fairlane Business Park #3  
Allen Park, Michigan 48101  
U.S.A.

Telephone: (313) 594-4857

For customers in Guam, the Commonwealth of the Northern Mariana Islands (CNMI), American Samoa, and the U.S. Virgin Islands, please feel free to call our Toll-Free Number: (800) 841-FORD (3673).

FAX: (313) 390-0804

Email: [expcac@ford.com](mailto:expcac@ford.com)

If your vehicle must be serviced while you are traveling or living in Puerto Rico, contact the nearest authorized dealer. If the authorized dealer cannot help you, contact:

Ford International Business Development Inc.  
Customer Relationship Center  
P.O. Box 11957  
Caparra Heights Station  
San Juan, Puerto Rico 00922-1957  
Telephone: (800) 841-FORD (3673)  
FAX: (313) 390-0804  
Email: [prcac@ford.com](mailto:prcac@ford.com)  
[www.ford.com.pr](http://www.ford.com.pr)

## Customer Assistance

If your vehicle must be serviced while you are traveling or living in the Middle East, contact the nearest authorized dealer. If the authorized dealer cannot help you, contact:

Ford Middle East  
Customer Relationship Center  
P.O. Box 21470  
Dubai, United Arab Emirates  
Telephone: +971 4 3326084  
Toll-Free Number for the Kingdom of Saudi Arabia: 800 8971409  
Local Telephone Number for Kuwait: 24810575  
FAX: +971 4 3327299  
Email: [menacac@ford.com](mailto:menacac@ford.com)  
[www.me.ford.com](http://www.me.ford.com)

If you buy your vehicle in North America and then relocate to any of the above locations, register your vehicle identification number (VIN) and new address with Ford Motor Company Export Operations & Global Growth Initiatives by emailing [expcac@ford.com](mailto:expcac@ford.com).

If you are in another foreign country, contact the nearest authorized dealer. If the authorized dealer employees cannot help you, they can direct you to the nearest Ford affiliate office.

**Customers in the U.S. should call 1-800-392-3673.**

### ORDERING ADDITIONAL OWNER'S LITERATURE

To order the publications in this portfolio, contact Helm, Incorporated at:

HELM, INCORPORATED  
P.O. Box 07150  
Detroit, Michigan 48207

Or to order a free publication catalog, call toll free: 1-800-782-4356  
Monday-Friday 8:00 a.m. - 6:00 p.m. EST

Helm, Incorporated can also be reached by their website:  
[www.helminc.com](http://www.helminc.com).

*(Items in this catalog may be purchased by credit card, check or money order.)*

### Obtaining a French Owner's Guide

French Owner's Guides can be obtained from your authorized dealer or by contacting Helm, Incorporated using the contact information listed previously in this section.

<https://www.MyCarManual.com>

219

## Customer Assistance

### REPORTING SAFETY DEFECTS (U.S. ONLY)

If you believe that your vehicle has a defect which could cause a crash or could cause injury or death, you should immediately inform the National Highway Traffic Safety Administration (NHTSA) in addition to notifying Ford Motor Company.



If NHTSA receives similar complaints, it may open an investigation, and if it finds that a safety defect exists in a group of vehicles, it may order a recall and remedy campaign. However, NHTSA cannot become involved in individual problems between you, your dealer, or Ford Motor Company.

To contact NHTSA, you may call the Vehicle Safety Hotline toll-free at 1-888-327-4236 (TTY: 1-800-424-9153); go to <http://www.safercar.gov>; or write to:

Administrator  
1200 New Jersey Avenue, Southeast  
Washington, D.C. 20590

You can also obtain other information about motor vehicle safety from <http://www.safercar.gov>.

### REPORTING SAFETY DEFECTS (CANADA ONLY)

If you believe that your vehicle has a defect which could cause a crash or could cause injury or death, you should immediately inform Transport Canada, using their toll-free number: 1-800-333-0510, or online at: <https://wwwapps.tc.gc.ca/Saf-Sec-Sur/7/PCDB-BDPP/Index.aspx>.

## Cleaning

### WASHING THE EXTERIOR

Wash your vehicle regularly with cool or lukewarm water and a neutral pH shampoo, such as Motorcraft® Detail Wash (ZC-3-A), which is available from your authorized dealer.

- Never use strong household detergents or soap, such as dish washing or laundry liquid. These products can discolor and spot painted surfaces.
- Never wash a vehicle that is “hot to the touch” or during exposure to strong, direct sunlight.
- Always use a clean sponge or car wash mitt with plenty of water for best results.
- Dry the vehicle with a chamois or soft terry cloth towel in order to eliminate water spotting.
- It is especially important to wash the vehicle regularly during the winter months, as dirt and road salt are difficult to remove and cause damage to the vehicle.
- Immediately remove items such as gasoline, diesel fuel, bird droppings and insect deposits because they can cause damage to the vehicle’s paintwork and trim over time. Use Motorcraft® Bug and Tar Remover (ZC-42) which is available from your authorized dealer.
- Remove any exterior accessories, such as antennas, before entering a car wash.
- **Suntan lotions and insect repellents can damage any painted surface; if these substances come in contact with your vehicle, wash off as soon as possible.**

### Exterior chrome

- Wash the vehicle first, using cool or lukewarm water and a neutral pH shampoo, such as Motorcraft® Detail Wash (ZC-3-A).
- Use Motorcraft® Custom Bright Metal Cleaner (ZC-15), available from your authorized dealer. Apply the product as you would a wax to clean bumpers and other chrome parts; allow the cleaner to dry for a few minutes, then wipe off the haze with a clean, dry rag.
- **Never use abrasive materials such as steel wool or plastic pads as they can scratch the chrome surface.**

### WAXING

- Wash the vehicle first.
- Use a quality wax that does not contain abrasives.

## Cleaning

- Do not allow paint sealant to come in contact with any non-body (low-gloss black) colored trim, such as grained door handles, roof racks, bumpers, side moldings, mirror housings or the windshield cowl area. The paint sealant will “gray” or stain the parts over time.

### PAINT CHIPS

Your authorized dealer has touch-up paint to match your vehicle’s color. Take your color code (printed on a sticker in the driver’s door jamb) to your authorized dealer to ensure you get the correct color.

- Remove particles such as bird droppings, tree sap, insect deposits, tar spots, road salt and industrial fallout before repairing paint chips.
- Always read the instructions before using the products.

### ALUMINUM WHEELS AND WHEEL COVERS

Aluminum wheels and wheel covers are coated with a clearcoat paint finish. In order to maintain their shine:

- Clean weekly with Motorcraft® Wheel and Tire Cleaner, which is available from your authorized dealer. Heavy dirt and brake dust accumulation may require agitation with a sponge. Rinse thoroughly with a strong stream of water.
- Never apply any cleaning chemical to hot or warm wheel rims or covers.
- Some automatic car washes may cause damage to the finish on your wheel rims or covers. Industrial-strength (heavy-duty) cleaners, or cleaning chemicals, in combination with brush agitation to remove brake dust and dirt, could wear away the clearcoat finish over time.
- Do not use hydrofluoric acid-based or high caustic-based wheel cleaners, steel wool, fuels or strong household detergent.
- To remove tar and grease, use Motorcraft® Bug and Tar Remover , available from your authorized dealer.

### ENGINE

Engines are more efficient when they are clean because grease and dirt buildup keep the engine warmer than normal. When washing:

- Take care when using a power washer to clean the engine. The high-pressure fluid could penetrate the sealed parts and cause damage.
- Do not spray a hot engine with cold water to avoid cracking the engine block or other engine components.

## Cleaning

- Spray Motorcraft® Engine Shampoo and Degreaser (ZC-20) on all parts that require cleaning and pressure rinse clean. In Canada, use Motorcraft® Engine Shampoo (CXC-66-A).
- Cover the highlighted areas to prevent water damage when cleaning the engine.

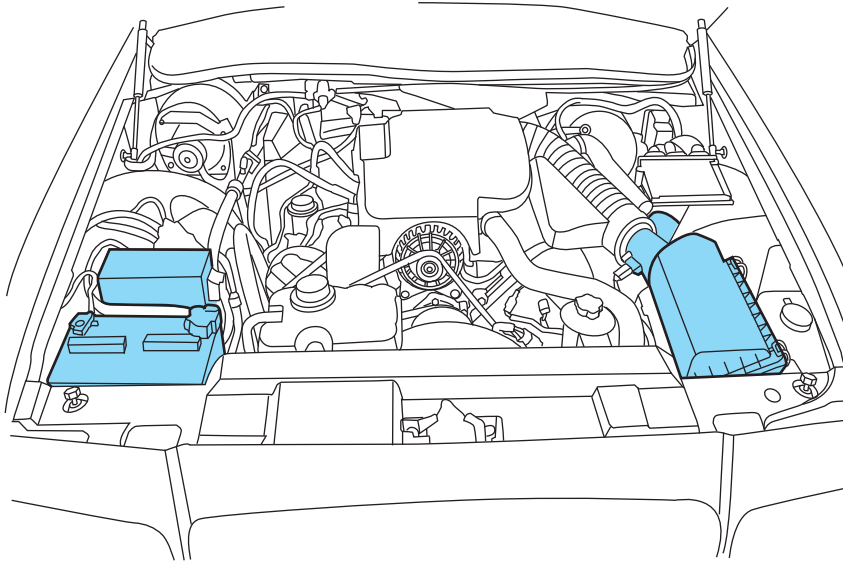

- Never wash or rinse the engine while it is hot or running; water in the running engine may cause internal damage.
- Never wash or rinse any ignition coil, spark plug wire or spark plug well, or the area in and around these locations.

### PLASTIC (NON-PAINTED) EXTERIOR PARTS

Use only approved products to clean plastic parts. These products are available from your authorized dealer.

- For routine cleaning, use Motorcraft® Detail Wash (ZC-3-A).
- If tar or grease spots are present, use Motorcraft® Bug and Tar Remover (ZC-42).

## Cleaning

### WINDOWS AND WIPER BLADES

The windshield, rear and side windows and the wiper blades should be cleaned regularly. If the wipers do not wipe properly, substances on the vehicle's glass or the wiper blades may be the cause. These may include hot wax treatments used by commercial car washes, water repellent coatings, tree sap, or other organic contamination; these contaminants may cause squeaking or chatter noise from the blades, and streaking and smearing of the windshield. To clean these items, follow these tips:

- The windshield, rear windows and side windows may be cleaned with a non-abrasive cleaner such as Motorcraft® Ultra-Clear Spray Glass Cleaner (ZC-23), available from your authorized dealer.
- The wiper blades can be cleaned with isopropyl (rubbing) alcohol or Motorcraft® Premium Windshield Washer Concentrate (ZC-32-A) in the U.S., or Premium Quality Windshield Washer Fluid [CXC-37-(A, B, D, or F)] in Canada, available from your authorized dealer. This washer fluid contains special solution in addition to alcohol which helps to remove the hot wax deposited on the wiper blade and windshield from automated car wash facilities. Be sure to replace wiper blades when they appear worn or do not function properly.
- Do not use abrasives, as they may cause scratches.
- Do not use fuel, kerosene, or paint thinner to clean any parts.

If you cannot remove those streaks after cleaning with the glass cleaner or if the wipers chatter and move in a jerky motion, clean the outer surface of the windshield and the wiper blades using a sponge or soft cloth with a neutral detergent or mild-abrasive cleaning solution. After cleaning, rinse the windshield and wiper blades with clean water. The windshield is clean if beads do not form when you rinse the windshield with water.

**Do not use sharp objects, such as a razor blade, to clean the inside of the rear window or to remove decals, as it may cause damage to the rear window defroster's heated grid lines.**

### INSTRUMENT PANEL/INTERIOR TRIM AND CLUSTER LENS

Clean the instrument panel, interior trim areas and cluster lens with a clean, damp, white cotton cloth, then use a clean and dry white cotton cloth to dry these areas.

- Avoid cleaners or polishes that increase the gloss of the upper portion of the instrument panel. The dull finish in this area helps protect the driver from undesirable windshield reflection.



## Cleaning

- Be certain to wash or wipe your hands clean if you have been in contact with certain products such as insect repellent and suntan lotion in order to avoid possible damage to the interior painted surfaces.
- Do not use household or glass cleaners as these may damage the finish of the instrument panel, interior trim and cluster lens.
- Do not allow air fresheners and hand sanitizers to spill on interior surfaces. If a spill occurs, **wipe off immediately**. Damage may not be covered by your warranty.



**WARNING:** Do not use chemical solvents or strong detergents when cleaning the steering wheel or instrument panel to avoid contamination of the airbag system.

If a staining liquid like coffee/juice has been spilled on the instrument panel or on interior trim surfaces, clean as follows:

1. Wipe up spilled liquid using a clean, white, cotton cloth.
2. Wipe the surface with a damp, clean, white cotton cloth. For more thorough cleaning, use a mild soap and water solution. If the spot cannot be completely cleaned by this method, the area may be cleaned using a commercially available cleaning product designed for automotive interiors.
3. If necessary, apply more soap and water solution or cleaning product to a clean, white, cotton cloth and press the cloth onto the soiled area—allow this to set at room temperature for 30 minutes.
4. Remove the soaked cloth, and if it is not soiled badly, use this cloth to clean the area by using a rubbing motion for 60 seconds.
5. Following this, wipe area dry with a clean, white, cotton cloth.

### INTERIOR

For fabric, carpets, cloth seats, safety belts and seats equipped with side airbags:

- Remove dust and loose dirt with a vacuum cleaner.
- Remove light stains and soil with Motorcraft® Professional Strength Carpet & Upholstery Cleaner (ZC-54).
- If grease or tar is present on the material, spot-clean the area first with Motorcraft® Spot and Stain Remover (ZC-14). In Canada, use Motorcraft® Multi-Purpose Cleaner (CXC-101).

## Cleaning

- If a ring forms on the fabric after spot cleaning, clean the entire area immediately (but do not oversaturate) or the ring will set.
- Do not use household cleaning products or glass cleaners, which can stain and discolor the fabric and affect the flame retardant abilities of the seat materials.



**WARNING:** Do not use cleaning solvents, bleach or dye on the vehicle's safety belts, as these actions may weaken the belt webbing.



**WARNING:** On vehicles equipped with seat-mounted airbags, do not use chemical solvents or strong detergents. Such products could contaminate the side-airbag system and affect performance of the side airbag in a collision.

### LEATHER SEATS (IF EQUIPPED, EXCEPT FOR THE KING RANCH® EDITION)

**For King Ranch® leather seats, refer to a separate section in this chapter.**

- Clean spills and stains as quickly as possible.
- For routine cleaning, wipe the surface with a soft, damp cloth. For more thorough cleaning, wipe the surface with a mild soap and water solution. In Canada, use Motorcraft® Vinyl Cleaner (CXC-93). Dry the area with a soft cloth.
- If the leather cannot be completely cleaned using a mild soap and water solution, the leather may be cleaned using a commercially available leather cleaning product designed for automotive interiors.
- To check for compatibility, first test any cleaner or stain remover on an inconspicuous part of the leather.
- Do not use household cleaning products, alcohol solutions, solvents or cleaners intended for rubber, vinyl and plastics, or oil/petroleum-based leather conditioners. These products may cause premature wearing or damage to the leather.

### LEATHER SEATS FOR THE KING RANCH® EDITION ONLY (IF EQUIPPED)

Your vehicle is equipped with seating covered in premium, top-grain leather which is extremely durable, but still requires special care and maintenance in order to ensure longevity and comfort.

## Cleaning

Regular cleaning and conditioning will maintain the appearance of the leather.

### **Cleaning**

For dirt, use a vacuum cleaner then use a clean, damp cloth or soft brush.

For routine cleaning, wipe the surface with a soft, damp cloth. For more thorough cleaning, wipe the surface with a mild soap and water solution.

- Clean spills as quickly as possible.
- Test any cleaner or stain remover on an inconspicuous part of the leather as cleaners may darken the leather.
- Do not spill coffee, ketchup, mustard, orange juice or oil-based products on the leather as they may permanently stain the leather.
- Do not use household cleaning products, alcohol solutions, solvents or cleaners intended for rubber, vinyl or plastics.

### **Scratches**

Natural Markings - Because the leather in the seat comes from genuine steer hides, there will be evidence of naturally occurring markings, such as small scars. These markings give character to the seating covers and should be considered as proof of a genuine leather product.

In order to lessen the appearance of certain scratches and other wear marks, apply conditioner on the affected area following the same instructions as in the *Conditioning* section.

### **Conditioning**

Bottles of King Ranch® Leather Conditioner are available at the King Ranch® Saddle Shop. Visit the website at [www.krsaddleshop.com](http://www.krsaddleshop.com), or telephone (in the United States) 1-800-282-KING (5464). If you are unable to obtain King Ranch® Leather Conditioner, use another premium leather conditioner.

- Clean the surfaces using the steps outlined in the *Cleaning* section.
- Ensure the leather is dry then apply a nickel-sized amount of conditioner to a clean, dry cloth.
- Rub the conditioner into leather until it disappears. Allow the conditioner to dry and repeat the process for the entire interior. If a film appears, wipe off film with a dry, clean cloth.

### **UNDERBODY**

Flush the complete underside of your vehicle frequently. Keep body and door drain holes free from packed dirt.

## Cleaning

### FORD AND LINCOLN CAR CARE PRODUCTS

Your Ford or Lincoln authorized dealer has many quality products available to clean your vehicle and protect its finishes. These quality products have been specifically engineered to fulfill your automotive needs; they are custom designed to complement the style and appearance of your vehicle. Each product is made from high quality materials that meet or exceed rigid specifications. For best results, use the following products or products of equivalent quality:

- Motorcraft® Bug and Tar Remover (ZC-42)
- Motorcraft® Custom Bright Metal Cleaner (ZC-15)
- Motorcraft® Detail Wash (ZC-3-A)
- Motorcraft® Dusting Cloth (ZC-24)
- Motorcraft® Engine Shampoo and Degreaser (U.S. only) (ZC-20)
- Motorcraft® Engine Shampoo (Canada only) (CXC-66-A)
- Motorcraft® Multi-Purpose Cleaner (Canada only) (CXC-101)
- Motorcraft® Premium Glass Cleaner (Canada only) (CXC-100)
- Motorcraft® Premium Quality Windshield Washer Fluid (Canada only) [CXC-37-(A, B, D or F)]
- Motorcraft® Premium Windshield Washer Concentrate (U.S. only) (ZC-32-A)
- Motorcraft® Professional Strength Carpet & Upholstery Cleaner (ZC-54)
- Motorcraft® Spot and Stain Remover (U.S. only) (ZC-14)
- Motorcraft® Ultra-Clear Spray Glass Cleaner (ZC-23)
- Motorcraft® Vinyl Cleaner (Canada only) (CXC-93)
- Motorcraft® Wheel and Tire Cleaner (ZC-37-A)

## Maintenance and Specifications

### SERVICE RECOMMENDATIONS

To help you service your vehicle, we provide *scheduled maintenance information* which makes tracking routine service easy.

If your vehicle requires professional service, your authorized dealer can provide the necessary parts and service. Check your *Warranty Guide* to find out which parts and services are covered.

Use only recommended fuels, lubricants, fluids and service parts conforming to specifications. Motorcraft® parts are designed and built to provide the best performance in your vehicle.

### PRECAUTIONS WHEN SERVICING YOUR VEHICLE

- Do not work on a hot engine.
- Make sure that nothing gets caught in moving parts.
- Do not work on a vehicle with the engine running in an enclosed space, unless you are sure you have enough ventilation.
- Keep all open flames and other burning material (such as cigarettes) away from the battery and all fuel related parts.

### Working with the engine off

1. Set the parking brake and ensure the gearshift is securely latched in P (Park).
2. Turn off the engine and remove the key.
3. Block the wheels to prevent the vehicle from moving unexpectedly.

## Maintenance and Specifications

### Working with the engine on

1. Set the parking brake and shift to P (Park).
2. Block the wheels.

 **WARNING:** To reduce the risk of vehicle damage and/or personal burn injuries, do not start your engine with the air cleaner removed and do not remove it while the engine is running.

### OPENING THE HOOD

1. Inside the vehicle, pull the hood release handle located under the instrument panel.
2. Go to the front of the vehicle and release the auxiliary latch that is located under the front of the hood.
3. Lift the hood until the lift cylinders hold it open.

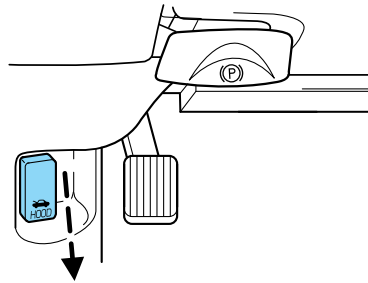

## Maintenance and Specifications

### IDENTIFYING COMPONENTS IN THE ENGINE COMPARTMENT

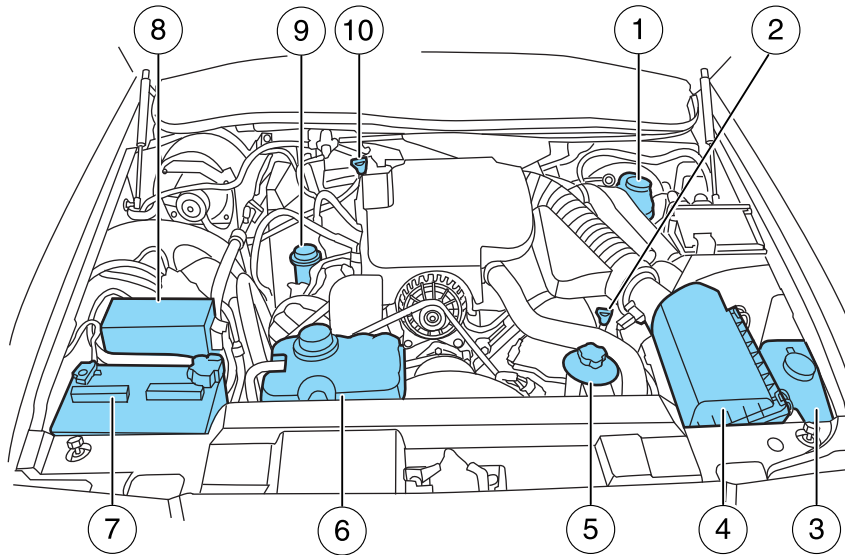

1. Brake fluid reservoir
2. Engine oil dipstick
3. Windshield washer fluid reservoir
4. Air filter assembly
5. Power steering fluid reservoir
6. Engine coolant reservoir
7. Battery
8. Power distribution box
9. Engine oil filler cap
10. Automatic transmission fluid dipstick

## Maintenance and Specifications

### WINDSHIELD WASHER FLUID

Add fluid to fill the reservoir if the level is low. In very cold weather, do not fill the reservoir completely.

Only use a washer fluid that meets Ford specifications. Do not use any special washer fluid such as windshield water repellent type fluid or bug wash. They may cause squeaking, chatter noise, streaking and smearing. Refer to *Maintenance product specifications and capacities* in this chapter.

State or local regulations on volatile organic compounds may restrict the use of methanol, a common windshield washer antifreeze additive.

Washer fluids containing non-methanol antifreeze agents should be used only if they provide cold weather protection without damaging the vehicle's paint finish, wiper blades or washer system.

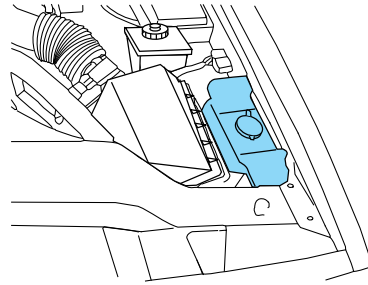

**WARNING:** If you operate your vehicle in temperatures below 40°F (5°C), use washer fluid with antifreeze protection. Failure to use washer fluid with antifreeze protection in cold weather could result in impaired windshield vision and increase the risk of injury or accident.

### CHANGING THE WIPER BLADES

1. Pull the wiper blade and arm away from the glass. Turn the blade as much as possible to gain access to the lock tab (A). Using a skinny tool, press the lock tab to release the blade from the arm loop and pull the blade from the arm.

2. Attach the new blade to the arm loop and pull it into place until a click is heard.

Replace wiper blades at least once per year for optimum performance.

Poor wiper quality can be improved by cleaning the wiper blades and the windshield. Refer to *Windows and wiper blades* in the *Cleaning* chapter.

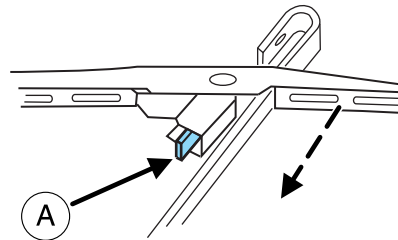



## Maintenance and Specifications

To prolong the life of the wiper blades, it is highly recommended to scrape off the ice on the windshield before turning on the wipers. The layer of ice has many sharp edges and can damage the micro edge of the wiper rubber element.

### ENGINE OIL

#### Checking the engine oil

Refer to the *scheduled maintenance information* for the appropriate intervals for checking the engine oil.

1. Make sure the vehicle is on level ground.
2. Turn the engine off and wait up to 15 minutes for the oil to drain into the oil pan.
3. Set the parking brake and ensure the gearshift is securely latched in P (Park).
4. Open the hood. Protect yourself from engine heat.
5. Locate and carefully remove the engine oil level dipstick.

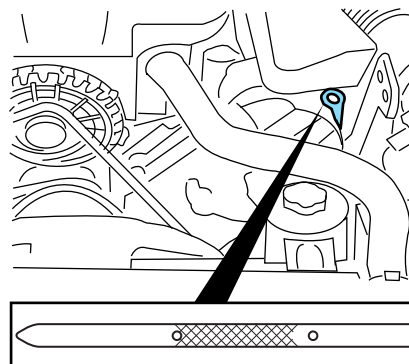

6. Wipe the dipstick clean. Insert the dipstick fully, then remove it again.

- If the oil level is **within this range**, the oil level is acceptable.  
**DO NOT ADD OIL.**

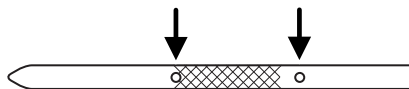

## Maintenance and Specifications

- If the oil level is **below this mark**, engine **oil must be added** to raise the level within the normal operating range.

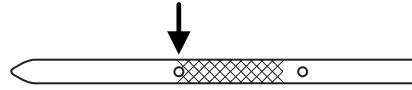

- If required, add engine oil to the engine. Refer to *Adding engine oil* in this chapter.
- **Do not overfill the engine with oil. Oil levels above this mark may cause engine damage.** If the engine is overfilled, some oil must be removed from the engine by an authorized dealer.

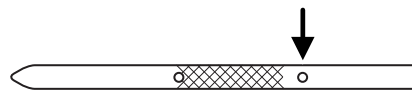

7. Put the dipstick back in and ensure it is fully seated.

### Adding engine oil

1. Check the engine oil. For instructions, refer to *Checking the engine oil* in this chapter.
2. If the engine oil level is not within the normal operating range, add only certified engine oil of the recommended viscosity. Remove the engine oil filler cap and use a funnel to pour the engine oil into the opening.
3. Recheck the engine oil level. Make sure the oil level is not above the normal operating range on the engine oil level dipstick.
4. Install the dipstick and ensure it is fully seated.
5. Fully install the engine oil filler cap by turning the filler cap clockwise until three clicks can be heard.

**To avoid possible oil loss, DO NOT operate the vehicle with the engine oil level dipstick and/or the engine oil filler cap removed.**

## Maintenance and Specifications

### Engine oil and filter recommendations

Look for this certification trademark.

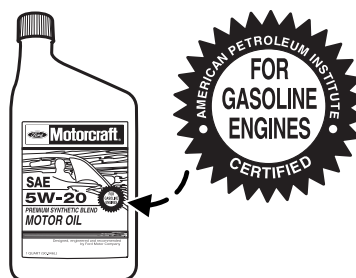

### Use SAE 5W-20 engine oil

Only use oils certified for gasoline engines by the American Petroleum Institute (API). An oil with this trademark symbol conforms to the current engine and emission system protection standards and fuel economy requirements of the International Lubricant Standardization and Approval Committee (ILSAC), comprised of U.S. and Japanese automobile manufacturers.

To protect your engine and engine's warranty, use Motorcraft® SAE 5W-20 or an equivalent SAE 5W-20 oil meeting Ford specification WSS-M2C930-A. **SAE 5W-20 oil provides optimum fuel economy and durability performance meeting all requirements for your vehicle's engine.** Refer to *Maintenance product specifications and capacities* later in this chapter for more information.

Do not use supplemental engine oil additives, cleaners or other engine treatments. They are unnecessary and could lead to engine damage that is not covered by Ford warranty.

Change your engine oil and filter according to the appropriate schedule listed in the *scheduled maintenance information*.

Ford production and Motorcraft® replacement oil filters are designed for added engine protection and long life. If a replacement oil filter is used that does not meet Ford material and design specifications, start-up engine noises or knock may be experienced.

It is recommended you use the appropriate Motorcraft® oil filter or another with equivalent performance for your engine application.

## Maintenance and Specifications

### BATTERY

Your vehicle is equipped with a Motorcraft® maintenance-free battery which normally does not require additional water during its life of service.

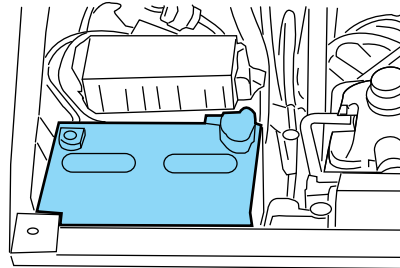

**If your battery has a cover/shield, make sure it is reinstalled after the battery has been cleaned or replaced.**

For longer, trouble-free operation, keep the top of the battery clean and dry. Also, make certain the battery cables are always tightly fastened to the battery terminals.

If you see any corrosion on the battery or terminals, remove the cables from the terminals and clean with a wire brush. You can neutralize the acid with a solution of baking soda and water.

It is recommended that the negative battery cable terminal be disconnected from the battery if you plan to store your vehicle for an extended period of time. This will minimize the discharge of your battery during storage.

**Note:** Electrical or electronic accessories or components added to the vehicle by the dealer or the owner may adversely affect battery performance and durability.

**!** **WARNING:** Batteries normally produce explosive gases which can cause personal injury. Therefore, do not allow flames, sparks or lighted substances to come near the battery. When working near the battery, always shield your face and protect your eyes. Always provide proper ventilation.

**!** **WARNING:** When lifting a plastic-cased battery, excessive pressure on the end walls could cause acid to flow through the vent caps, resulting in personal injury and/or damage to the vehicle or battery. Lift the battery with a battery carrier or with your hands on opposite corners.

## Maintenance and Specifications

 **WARNING:** Keep batteries out of reach of children. Batteries contain sulfuric acid. Avoid contact with skin, eyes or clothing. Shield your eyes when working near the battery to protect against possible splashing of acid solution. In case of acid contact with skin or eyes, flush immediately with water for a minimum of 15 minutes and get prompt medical attention. If acid is swallowed, call a physician immediately.

 **WARNING:** Battery posts, terminals and related accessories contain lead and lead compounds. **Wash hands after handling.**

Because your vehicle's engine is electronically controlled by a computer, some control conditions are maintained by power from the battery. When the battery is disconnected or a new battery is installed, the engine must relearn its idle and fuel trim strategy for optimum driveability and performance. Flexible fuel vehicles (FFV) must also relearn the ethanol content of the fuel for optimum driveability and performance. To begin this process:

1. With the vehicle at a complete stop, set the parking brake.
2. Put the gearshift in P (Park), turn off all accessories and start the engine.
3. Run the engine until it reaches normal operating temperature.
4. Allow the engine to idle for at least one minute.
5. Turn the A/C on and allow the engine to idle for at least one minute.
6. Release the parking brake. With your foot on the brake pedal and with the A/C on, put the vehicle in D (Drive) and allow the engine to idle for at least one minute.
7. Drive the vehicle to complete the relearning process.
  - The vehicle may need to be driven 10 miles (16 km) or more to relearn the idle and fuel trim strategy along with the ethanol content for flexible fuel vehicles.
  - **If you do not allow the engine to relearn its idle trim, the idle quality of your vehicle may be adversely affected until the idle trim is eventually relearned.**
  - For flexible fuel vehicles, if you are operating on E85, you may experience poor starts or an inability to start the engine and driveability problems until the fuel trim and ethanol content have been relearned.

## Maintenance and Specifications

If the battery has been disconnected or a new battery has been installed, the clock and radio settings must be reset once the battery is reconnected.

- Always dispose of automotive batteries in a responsible manner. Follow your local authorized standards for disposal. Call your local authorized recycling center to find out more about recycling automotive batteries.

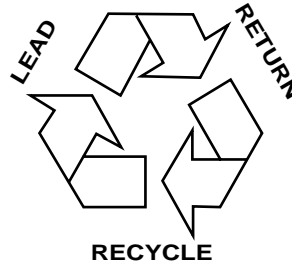

### ENGINE COOLANT

#### Checking engine coolant

The concentration and level of engine coolant should be checked at the intervals listed in *scheduled maintenance information*. The coolant concentration should be maintained at 50/50 coolant and distilled water. For best results, coolant concentration should be tested with a refractometer such as Rotunda tool 300- ROB75240E available from your dealer. Ford does not recommend the use of hydrometers or coolant test strips for measuring coolant concentration. The level of coolant should be maintained at the FULL COLD level or within the COLD FILL RANGE in the coolant reservoir. If the level falls below, add coolant per the instructions in the *Adding engine coolant* section.

Your vehicle was factory-filled with a 50/50 engine coolant and water concentration. If the concentration of coolant falls below 40% or above 60%, the engine parts could become damaged or not work properly. **A 50/50 mixture of coolant and water provides the following:**

- **Improved freeze protection.**
- **Improved boiling protection.**
- **Protection against rust and other forms of corrosion.**
- **Proper function of calibrated gauges.**

## Maintenance and Specifications

When the engine is cold, check the level of the engine coolant in the reservoir.

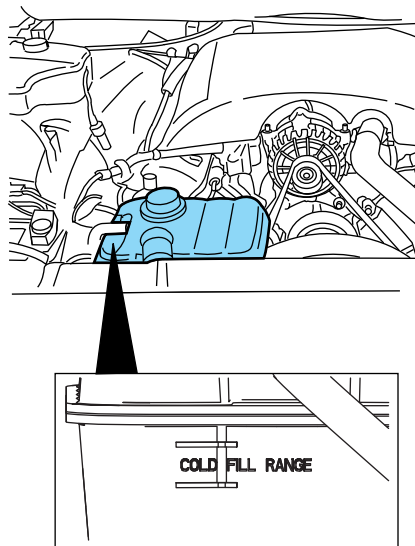

- The engine coolant should be at the FULL COLD level, or within the COLD FILL or MIN / MAX range as listed on the engine coolant reservoir (depending upon application).
- Refer to *scheduled maintenance information* for service interval schedules.

If the engine coolant has not been checked at the recommended interval, the engine coolant reservoir may become low or empty. If the reservoir is low or empty, add engine coolant to the reservoir. Refer to *Adding engine coolant* in this chapter.

**Note:** Automotive fluids are not interchangeable; do not use engine coolant/antifreeze or windshield washer fluid outside of its specified function and vehicle location.

### Adding engine coolant

When adding coolant, make sure it is a 50/50 mixture of engine coolant and distilled water. Add the mixture to the coolant reservoir, **when the engine is cool**, until the appropriate fill level is obtained. If coolant is filled to the COLD FILL RANGE or FULL COLD level when the engine is not cool, the system will remain underfilled.

## Maintenance and Specifications



**WARNING:** Do not add engine coolant when the engine is hot. Steam and scalding liquids released from a hot cooling system can burn you badly. Also, you can be burned if you spill coolant on hot engine parts.



**WARNING:** Do not put engine coolant in the windshield washer fluid container. If sprayed on the windshield, engine coolant could make it difficult to see through the windshield.

- **DO NOT MIX** different colors or types of coolant in your vehicle. Make sure the correct coolant is used. Mixing of engine coolants may harm your engine's cooling system. The use of an improper coolant may harm engine and cooling system components and may void the warranty. Refer to *Maintenance product specifications and capacities* in this chapter.
- A large amount of water without engine coolant may be added, in case of emergency, to reach a vehicle service location. In this instance, the cooling system must be drained and refilled with a 50/50 mixture of engine coolant and distilled water as soon as possible. Water alone (without engine coolant) can cause engine damage from corrosion, overheating or freezing.
- **Do not use alcohol, methanol, brine or any engine coolants mixed with alcohol or methanol antifreeze (coolant).** Alcohol and other liquids can cause engine damage from overheating or freezing.
- **Do not add extra inhibitors or additives to the coolant.** These can be harmful and compromise the corrosion protection of the engine coolant.

For vehicles with overflow coolant systems with a non-pressurized cap on the coolant recovery system, add coolant to the coolant recovery reservoir when the engine is cool. Add the proper mixture of coolant and distilled water to the FULL COLD level. For all other vehicles which have a coolant degas system with a pressurized cap, or if it is necessary to remove the coolant pressure relief cap on the radiator of a vehicle with an overflow system, follow these steps to add engine coolant.



**WARNING:** To reduce the risk of personal injury, make sure the engine is cool before unscrewing the coolant pressure relief cap. The cooling system is under pressure; steam and hot liquid can come out forcefully when the cap is loosened slightly.



## Maintenance and Specifications

Add the proper mixture of coolant and water to the cooling system by following these steps:

1. Before you begin, turn the engine off and let it cool.
2. When the engine is cool, wrap a thick cloth around the coolant pressure relief cap on the coolant reservoir (a translucent plastic bottle). Slowly turn cap counterclockwise (left) until pressure begins to release.
3. Step back while the pressure releases.
4. When you are sure that all the pressure has been released, use the cloth to turn it counterclockwise and remove the cap.
5. Fill the coolant reservoir slowly with the proper coolant mixture, to within the COLD FILL RANGE or the FULL COLD level on the reservoir. If you removed the radiator cap in an overflow system, fill the radiator until the coolant is visible and radiator is almost full.
6. Replace the cap. Turn until tightly installed. Cap must be tightly installed to prevent coolant loss.

After any coolant has been added, check the coolant concentration (refer to *Checking engine coolant*). If the concentration is not 50/50, drain some coolant and adjust the concentration. It may take several drains and additions to obtain a 50/50 coolant concentration.

Whenever coolant has been added, the coolant level in the coolant reservoir should be checked the next few times you drive the vehicle. If necessary, add enough 50/50 concentration of engine coolant and distilled water to bring the liquid level to the proper level.

If you have to add more than 1.0 quart (1.0 liter) of engine coolant per month, have your authorized dealer check the engine cooling system. Your cooling system may have a leak. Operating an engine with a low level of coolant can result in engine overheating and possible engine damage.

### Recycled engine coolant

Ford Motor Company does NOT recommend the use of recycled engine coolant since a Ford-approved recycling process is not yet available.



Used engine coolant should be disposed of in an appropriate manner. Follow your community's regulations and standards for recycling and disposing of automotive fluids.

### Coolant refill capacity

To find out how much fluid your vehicle's cooling system can hold, refer to *Maintenance product specifications and capacities* in this chapter.

## Maintenance and Specifications

Fill your engine coolant reservoir as outlined previously in the *Adding engine coolant* section.

### Severe climates

If you drive in extremely cold climates:

- **It may be necessary to increase the coolant concentration above 50%.**
- **NEVER increase the coolant concentration above 60%.**
- **A coolant concentration of 60% will provide improved freeze point protection. Increased engine coolant concentrations above 60% will decrease the overheat protection characteristics of the engine coolant and may cause engine damage.**
- **If available, refer to the chart on the coolant container to ensure the coolant concentration in your vehicle will provide adequate freeze protection at the temperatures in which you drive in the winter months.**

If you drive in extremely hot climates:

- **It is still necessary to maintain the coolant concentration above 40%.**
- **NEVER decrease the coolant concentration below 40%.**
- **Decreased engine coolant concentrations below 40% will decrease the corrosion/freeze protection characteristics of the engine coolant and may cause engine damage.**
- **If available, refer to the chart on the coolant container to ensure the coolant concentration in your vehicle will provide adequate protection at the temperatures in which you drive.**

Vehicles driven year-round in non-extreme climates should use a 50/50 mixture of engine coolant and distilled water for optimum cooling system and engine protection.

### What you should know about fail-safe cooling



If the engine coolant supply is depleted, this feature allows the vehicle to be driven temporarily before incremental component damage is incurred. The “fail-safe” distance depends on ambient temperatures, vehicle load and terrain.

#### ***How fail-safe cooling works***

If the engine begins to overheat:

- The engine coolant temperature gauge will move to the H (hot) area.

## Maintenance and Specifications

- The *service engine soon*  indicator light will illuminate.
- The message center (if equipped) will display COOLANT OVER TEMPERATURE.
- The  symbol will illuminate.

If the engine reaches a preset over-temperature condition, the engine will automatically switch to alternating cylinder operation. Each disabled cylinder acts as an air pump and cools the engine.

When this occurs the vehicle will still operate. However:

- The engine power will be limited.
- The air conditioning system will be disabled.

Continued operation will increase the engine temperature:

- The engine will completely shut down, causing steering and braking effort to increase.

Once the engine temperature cools, the engine can be re-started. Take your vehicle to an authorized dealer as soon as possible to minimize engine damage.

### **When fail-safe mode is activated**

You have limited engine power when in the fail-safe mode, so drive the vehicle with caution. The vehicle will not be able to maintain high-speed operation and the engine will run rough. Remember that the engine is capable of completely shutting down automatically to prevent engine damage, therefore:

1. Pull off the road as soon as safely possible and turn off the engine.
2. Arrange for the vehicle to be taken to an authorized dealer.
3. If this is not possible, wait a short period for the engine to cool.
4. Check the coolant level and replenish if low.



**WARNING:** Fail-safe mode is for use during emergencies only.

Operate the vehicle in fail-safe mode only as long as necessary to bring the vehicle to rest in a safe location and seek immediate repairs. When in fail-safe mode, the vehicle will have limited power, will not be able to maintain high-speed operation, and may completely shut down without warning, potentially losing engine power, power steering assist, and power brake assist, which may increase the possibility of a crash resulting in serious injury.

## Maintenance and Specifications



**WARNING:** Never remove the coolant reservoir cap while the engine is running or hot.

5. Re-start the engine and take your vehicle to an authorized dealer.

**Driving the vehicle without repairing the engine problem increases the chance of engine damage. Take your vehicle to an authorized dealer as soon as possible.**

### FUEL FILTER

For fuel filter replacement, see your authorized dealer. Refer to *scheduled maintenance information* for the appropriate intervals for changing the fuel filter.

**Replace the fuel filter with an authorized Motorcraft® part. The customer warranty may be void for any damage to the fuel system if an authorized Motorcraft® fuel filter is not used.**

### WHAT YOU SHOULD KNOW ABOUT AUTOMOTIVE FUELS

#### Important safety precautions



**WARNING:** Do not overfill the fuel tank. The pressure in an overfilled tank may cause leakage and lead to fuel spray and fire.



**WARNING:** The fuel system may be under pressure. If the fuel filler cap is venting vapor or if you hear a hissing sound, wait until it stops before completely removing the fuel filler cap. Otherwise, fuel may spray out and injure you or others.



**WARNING:** If you do not use the proper fuel filler cap, excessive vacuum in the fuel tank may damage the fuel system or cause the fuel cap to disengage in a collision, which may result in serious personal injury.



**WARNING:** Automotive fuels can cause serious injury or death if misused or mishandled.



**WARNING:** Fuel ethanol and gasoline may contain benzene, which is a cancer-causing agent.

## Maintenance and Specifications

Observe the following guidelines when handling automotive fuel:

- Extinguish all smoking materials and any open flames before fueling your vehicle.
- Always turn off the vehicle before fueling.
- Automotive fuels can be harmful or fatal if swallowed. Fuels such as gasoline and ethanol are highly toxic and if swallowed can cause death or permanent injury. If fuel is swallowed, call a physician immediately, even if no symptoms are immediately apparent. The toxic effects of fuel may not be visible for hours.
- Avoid inhaling fuel vapors. Inhaling too much fuel vapor of any kind can lead to eye and respiratory tract irritation. In severe cases, excessive or prolonged breathing of fuel vapor can cause serious illness and permanent injury.
- Avoid getting fuel liquid in your eyes. If fuel is splashed in the eyes, remove contact lenses (if worn), flush with water for 15 minutes and seek medical attention. Failure to seek proper medical attention could lead to permanent injury.
- Fuels can also be harmful if absorbed through the skin. If fuel is splashed on the skin and/or clothing, promptly remove contaminated clothing and wash skin thoroughly with soap and water. Repeated or prolonged skin contact with fuel liquid or vapor causes skin irritation.
- Be particularly careful if you are taking “Antabuse” or other forms of disulfiram for the treatment of alcoholism. Breathing gasoline and/or ethanol vapors, or skin contact could cause an adverse reaction. In sensitive individuals, serious personal injury or sickness may result. If fuel is splashed on the skin, promptly wash skin thoroughly with soap and water. Consult a physician immediately if you experience an adverse reaction.
- FFV fuel tanks may contain zero to 85% ethanol. Any fuel blends containing gasoline and ethanol should be treated the same as “Fuel Ethanol.” To identify if your vehicle is an FFV, it may be equipped with a yellow fuel cap with the text “E85/Gasoline”, or check if there is a label on the fuel filler door.



## Maintenance and Specifications

Pure ethanol is the alcohol which is the intoxicating agent in liquor, beer and wine. It is distilled from the fermentation of plants such as field corn and sugar cane. When ethanol is produced for use in motor fuels, a small amount of gasoline is added to make it unfit for beverage use. The resulting ethanol blend is called denatured fuel ethanol meaning that it is denatured with 2% to 5% gasoline and is suitable for automotive use.

During the summer season, fuel ethanol may contain a maximum of 85% denatured ethanol (Ed85) and 15% unleaded gasoline. The fuel ethanol has a higher octane rating than unleaded regular or premium gasoline and this allows the design of engines with greater efficiency and power.

Winter blends may contain up to 75% denatured ethanol (Ed75) and up to 25% unleaded gasoline to enhance cold engine starts. Severely cold weather may require additional measures for reliable starting. Refer to *Starting* in the *Driving* chapter.

Ethanol is more chemically active than gasoline. It corrodes some metals and causes some plastic and rubber components to swell, break down or become brittle and crack, especially when mixed with gasoline. Special materials and procedures have been developed for flexible fuel vehicles and the dispensers used by ethanol fuel providers.



**WARNING:** Flexible fuel components and standard unleaded gasoline fuel components are not interchangeable. If your vehicle is not serviced in accordance with flexible fuel vehicles procedures, damage may occur and your warranty may be invalidated.



**WARNING:** When refueling always shut the engine off and never allow sparks or open flames near the filler neck. Never smoke while refueling. Fuel vapor is extremely hazardous under certain conditions. Care should be taken to avoid inhaling excess fumes.



**WARNING:** The flow of fuel through a fuel pump nozzle can produce static electricity, which can cause a fire if fuel is pumped into an ungrounded fuel container.

## Maintenance and Specifications

### Refueling



**WARNING:** Fuel vapor burns violently and a fuel fire can cause severe injuries. To help avoid injuries to you and others:

- Read and follow all the instructions on the pump island;
- Turn off your engine when you are refueling;
- Do not smoke if you are near fuel or refueling your vehicle;
- Keep sparks, flames and smoking materials away from fuel;
- Stay outside your vehicle and do not leave the fuel pump unattended when refueling your vehicle — this is against the law in some places;
- Keep children away from the fuel pump; never let children pump fuel.
- Do not use personal electronic devices while refueling.

Use the following guidelines to avoid electrostatic charge build-up when filling an ungrounded fuel container:

- Place approved fuel container on the ground.
- DO NOT fill a fuel container while it is in the vehicle (including the cargo area).
- Keep the fuel pump nozzle in contact with the fuel container while filling.
- DO NOT use a device that would hold the fuel pump handle in the fill position.



### Fuel filler cap

When fueling your vehicle:

1. Turn the engine off.
2. Carefully turn the filler cap counterclockwise until it spins off.
3. Pull to remove the cap from the fuel filler pipe.
4. To install the cap, align the tabs on the cap with the notches on the filler pipe.
5. Turn the filler cap clockwise until it clicks at least once.

If the check fuel cap light  or a CHECK FUEL CAP message comes on, the fuel filler cap may not be properly installed. The light or message can come on after several driving events after you've refueled your vehicle.

## Maintenance and Specifications

At the next opportunity, safely pull off of the road, remove the fuel filler cap, align the cap properly and reinstall it. The check fuel cap light  or CHECK FUEL CAP message may not reset immediately; it may take several driving cycles for the check fuel cap light  or CHECK FUEL CAP message to turn off. A driving cycle consists of an engine start-up (after four or more hours with the engine off) followed by city and highway driving.

Continuing to drive with the check fuel cap light  or CHECK FUEL CAP message on may cause the  light to turn on as well.

**If you must replace the fuel filler cap, replace it with a fuel filler cap that is designed for your vehicle. The customer warranty may be void for any damage to the fuel tank or fuel system if the correct genuine Ford, Motorcraft or other certified fuel filler cap is not used.**



**WARNING:** The fuel system may be under pressure. If the fuel filler cap is venting vapor or if you hear a hissing sound, wait until it stops before completely removing the fuel filler cap. Otherwise, fuel may spray out and injure you or others.



**WARNING:** If you do not use the proper fuel filler cap, excessive vacuum in the fuel tank may damage the fuel system or cause the fuel cap to disengage in a collision, which may result in personal injury.

### ***FFV (Flex Fuel Vehicle) fuel cap***

If your vehicle is FFV capable, it will have a yellow colored fuel cap.

### **Choosing the right fuel**

If your vehicle is a flexible fuel vehicle (FFV), use only UNLEADED FUEL and FUEL ETHANOL (Ed75–Ed85).

If your vehicle is not a flexible fuel vehicle (FFV), then only use UNLEADED fuel or UNLEADED fuel blended with a maximum of 10% ethanol. Do not use fuel ethanol (E85), diesel, methanol, leaded fuel or any other fuel.

The use of leaded fuel is prohibited by law and could damage your vehicle.

Your vehicle was not designed to use fuel or fuel additives with metallic compounds, including manganese-based additives.



## Maintenance and Specifications

**Note:** Use of any fuel other than those recommended may cause powertrain damage, a loss of vehicle performance, and repairs may not be covered under warranty.

### Cleaner air

Ford endorses the use of reformulated “cleaner-burning” gasolines to improve air quality, per the recommendations in the *Choosing the right fuel* section.

### Octane recommendations

Your vehicle is designed to use “Regular” unleaded gasoline with a pump (R+M)/2 octane rating of 87. Some stations offer fuels posted as “Regular” with an octane rating below 87, particularly in high altitude areas. Fuels with octane levels below 87 are not recommended.

Do not be concerned if your engine sometimes knocks lightly. However, if it knocks heavily under most driving conditions while you are using fuel with the recommended octane rating, see your authorized dealer to prevent any engine damage.

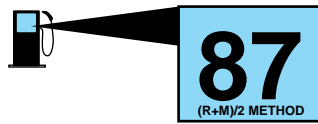

### FFV engine (if equipped)

If your vehicle is flex fuel capable, it is designed to use Fuel Ethanol (E75–E85), “Regular” unleaded gasoline or any mixture of the two fuels.

**Use of other fuels such as Fuel Methanol may cause powertrain damage, a loss of vehicle performance, and your warranty may be invalidated.**

It is best not to alternate repeatedly between gasoline and E85. If you do switch fuels, it is recommended that you add as much fuel as possible—at least half a tank. Do not add less than five gallons (18.9L) when refueling. You should drive the vehicle immediately after refueling for at least 5 miles (8 km) to allow the vehicle to adapt to the change in ethanol concentration.

If you exclusively use E85 fuel, it is recommended to fill the fuel tank with regular unleaded gasoline at each scheduled oil change.

### Fuel quality

#### *Unleaded gasoline engines*

If you experience starting, rough idle or hesitation driveability problems during a cold start, try a different brand of “Regular” unleaded gasoline.

## Maintenance and Specifications

“Premium” unleaded gasoline is not recommended for vehicles designed to use “Regular” unleaded gasoline because it may cause these problems to become more pronounced. If the problems persist, see your authorized dealer.

### *FFV engines*

If you experience starting, rough idle or hesitation driveability problems during a cold start, try a different brand of E85 fuel. If the driveability problems continue, fill the vehicle with regular unleaded gasoline and drive vehicle normally until gasoline is used. See your authorized dealer if the problem persists.



Do not add aftermarket fuel additive products to your fuel tank. It should not be necessary to add any aftermarket products to your fuel tank if you continue to use high quality fuel of the recommended octane rating. These products have not been approved for your engine and could cause damage to the fuel system. Repairs to correct the effects of using an aftermarket product in your fuel may not be covered by your warranty.

Many of the world’s automakers approved the World-Wide Fuel Charter that recommends gasoline specifications to provide improved performance and emission control system protection for your vehicle. Gasolines that meet the World-Wide Fuel Charter should be used when available. Ask your fuel supplier about gasolines that meet the World-Wide Fuel Charter.

### **Running out of fuel**

Avoid running out of fuel because this situation may have an adverse effect on powertrain components.

If you have run out of fuel:

- You may need to cycle the ignition from off to on several times after refueling to allow the fuel system to pump the fuel from the tank to the engine. On restarting, cranking time will take a few seconds longer than normal.
- Normally, adding 1 gallon (3.8L) of fuel is enough to restart the engine. If the vehicle is out of fuel and on a steep grade, more than 1 gallon (3.8L) may be required.
- The service engine soon  indicator may come on. For more information on the service engine soon  indicator, refer to *Warning lights and chimes* in the *Instrument Cluster* chapter.

## Maintenance and Specifications

### ESSENTIALS OF GOOD FUEL ECONOMY

#### Measuring techniques

Your best source of information about actual fuel economy is you, the driver. You must gather information as accurately and consistently as possible. Fuel expense, frequency of fill-ups or fuel gauge readings are NOT accurate as a measure of fuel economy. We do not recommend taking fuel economy measurements during the first 1,000 miles (1,600 km) of driving (engine break-in period). You will get a more accurate measurement after 2,000 miles–3,000 miles (3,000 km–5,000 km).

#### Filling the tank

The advertised fuel capacity of the fuel tank on your vehicle is equal to the rated refill capacity of the fuel tank as listed in the *Maintenance product specifications and capacities* section of this chapter.

The advertised capacity is the amount of the indicated capacity and the empty reserve combined. Indicated capacity is the difference in the amount of fuel in a full tank and a tank when the fuel gauge indicates empty. Empty reserve is the small amount of fuel remaining in the fuel tank after the fuel gauge indicates empty.

**The amount of usable fuel in the empty reserve varies and should not be relied upon to increase driving range. When refueling your vehicle after the fuel gauge indicates empty, you might not be able to refuel the full amount of the advertised capacity of the fuel tank due to the empty reserve still present in the tank.**

For consistent results when filling the fuel tank:

- Turn the engine/ignition switch to the off position prior to refueling, an error in the reading will result if the engine is left running.
- Use the same filling rate setting (low — medium — high) each time the tank is filled.
- Allow no more than two automatic click-offs when filling.
- Always use fuel with the recommended octane rating.
- Use a known quality gasoline, preferably a national brand.
- Have the vehicle loading and distribution the same every time.

Your results will be most accurate if your filling method is consistent.

#### Calculating fuel economy

1. Fill the fuel tank completely and record the initial odometer reading (in miles or kilometers).

## Maintenance and Specifications

2. Each time you fill the tank, record the amount of fuel added (in gallons or liters).
3. After at least three to five tank fill-ups, fill the fuel tank and record the current odometer reading.
4. Subtract your initial odometer reading from the current odometer reading.
5. Follow one of the simple calculations in order to determine fuel economy:

Calculation 1: **Divide total miles traveled by total gallons used.**

Calculation 2: **Multiply liters used by 100, then divide by total kilometers traveled.**

Keep a record for at least one month and record the type of driving (city or highway). This will provide an accurate estimate of the vehicle's fuel economy under current driving conditions. Additionally, keeping records during summer and winter will show how temperature impacts fuel economy. In general, lower temperatures give lower fuel economy.

### Driving style — good driving and fuel economy habits

Give consideration to the lists that follow and you may be able to change a number of variables and improve your fuel economy.

#### **Habits**

- Smooth, moderate operation can yield up to 10% savings in fuel.
- Steady speeds without stopping will usually give the best fuel economy.
- Idling for long periods of time (greater than one minute) may waste fuel.
- Anticipate stopping; slowing down may eliminate the need to stop.
- Sudden or hard accelerations may reduce fuel economy.
- Slow down gradually.
- Driving at reasonable speeds (traveling at 55 mph [88 km/h] uses 15% less fuel than traveling at 65 mph [105 km/h]).
- Revving the engine before turning it off may reduce fuel economy.
- Using the air conditioner or defroster may reduce fuel economy.
- You may want to turn off the speed control in hilly terrain if unnecessary shifting between the top gears occurs. Unnecessary shifting of this type could result in reduced fuel economy.

## Maintenance and Specifications

- Warming up a vehicle on cold mornings is not required and may reduce fuel economy.
- Resting your foot on the brake pedal while driving may reduce fuel economy.
- Combine errands and minimize stop-and-go driving.

### **Maintenance**

- Keep tires properly inflated and use only recommended size.
- Operating a vehicle with the wheels out of alignment will reduce fuel economy.
- Use recommended engine oil. Refer to *Maintenance product specifications and capacities* in this chapter.
- Perform all regularly scheduled maintenance items. Follow the recommended maintenance schedule and owner maintenance checks found in *scheduled maintenance information*.

### **Conditions**

- Heavily loading a vehicle or towing a trailer may reduce fuel economy at any speed.
- Carrying unnecessary weight may reduce fuel economy (approximately 1 mpg [0.4 km/L] is lost for every 400 lb [180 kg] of weight carried).
- Adding certain accessories to your vehicle (for example bug deflectors, rollbars/light bars, running boards, ski racks) may reduce fuel economy.
- Using fuel blended with alcohol may lower fuel economy.
- Fuel economy may decrease with lower temperatures during the first 8–10 miles (12–16 km) of driving.
- Driving on flat terrain offers improved fuel economy as compared to driving on hilly terrain.
- Transmissions give their best fuel economy when operated in the top cruise gear and with steady pressure on the gas pedal.
- Close windows for high speed driving.

## Maintenance and Specifications

### EMISSION CONTROL SYSTEM

Your vehicle is equipped with various emission control components and a catalytic converter which will enable your vehicle to comply with applicable exhaust emission standards. To make sure that the catalytic converter and other emission control components continue to work properly:

- Use only the specified fuel listed.
- Avoid running out of fuel.
- Do not turn off the ignition while your vehicle is moving, especially at high speeds.
- Have the items listed in *scheduled maintenance information* performed according to the specified schedule.

The scheduled maintenance items listed in *scheduled maintenance information* are essential to the life and performance of your vehicle and to its emissions system.

If other than Ford, Motorcraft® or Ford-authorized parts are used for maintenance replacements or for service of components affecting emission control, such non-Ford parts should be equivalent to genuine Ford Motor Company parts in performance and durability.



**WARNING:** Do not park, idle, or drive your vehicle in dry grass or other dry ground cover. The emission system heats up the engine compartment and exhaust system, which can start a fire.

Illumination of the service engine soon  indicator, charging system warning light or the temperature warning light, fluid leaks, strange odors, smoke or loss of engine power could indicate that the emission control system is not working properly.

An improperly operating or damaged exhaust system may allow exhaust to enter the vehicle. Have a damaged or improperly operating exhaust system inspected and repaired immediately.





**WARNING:** Exhaust leaks may result in entry of harmful and potentially lethal fumes into the passenger compartment.

## Maintenance and Specifications

Do not make any unauthorized changes to your vehicle or engine. By law, vehicle owners and anyone who manufactures, repairs, services, sells, leases, trades vehicles, or supervises a fleet of vehicles are not permitted to intentionally remove an emission control device or prevent it from working. Information about your vehicle's emission system is on the Vehicle Emission Control Information Decal located on or near the engine. This decal also lists engine displacement.



Please consult your *Warranty Guide* for complete emission warranty information.

### On-board diagnostics (OBD-II)

Your vehicle is equipped with a computer that monitors the engine's emission control system. This system is commonly known as the on-board diagnostics system (OBD-II). The OBD-II system protects the environment by ensuring that your vehicle continues to meet government emission standards. The OBD-II system also assists your authorized dealer in properly servicing your vehicle. When the service engine soon  indicator illuminates, the OBD-II system has detected a malfunction. Temporary malfunctions may cause the service engine soon  indicator to illuminate. Examples are:

1. The vehicle has run out of fuel—the engine may misfire or run poorly.
2. Poor fuel quality or water in the fuel—the engine may misfire or run poorly.
3. The fuel cap may not have been securely tightened. See *Fuel filler cap* in this chapter.
4. Driving through deep water—the electrical system may be wet.

These temporary malfunctions can be corrected by filling the fuel tank with good quality fuel, properly tightening the fuel cap or letting the electrical system dry out. After three driving cycles without these or any other temporary malfunctions present, the service engine soon  indicator should stay off the next time the engine is started. A driving cycle consists of a cold engine startup followed by mixed city/highway driving. No additional vehicle service is required.



If the service engine soon  indicator remains on, have your vehicle serviced at the first available opportunity. Although some malfunctions detected by the OBD-II may not have symptoms that are apparent, continued driving with the service engine soon  indicator on can result in increased emissions, lower fuel economy, reduced engine and transmission smoothness, and lead to more costly repairs.

## Maintenance and Specifications

### Readiness for Inspection/Maintenance (I/M) testing

Some state/provincial and local governments may have Inspection/Maintenance (I/M) programs to inspect the emission control equipment on your vehicle. Failure to pass this inspection could prevent you from getting a vehicle registration. Your vehicle may not pass the I/M test if the service engine soon  indicator is on or not working properly (bulb is burned out), or if the OBD-II system has determined that some of the emission control systems have not been properly checked. In this case, the vehicle is considered not ready for I/M testing.

If the service engine soon  indicator is on or the bulb does not work, the vehicle may need to be serviced. Refer to *On-board diagnostics (OBD-II)* in this chapter.

If the vehicle's engine or transmission has just been serviced, or the battery has recently run down or been replaced, the OBD-II system may indicate that the vehicle is not ready for I/M testing. To determine if the vehicle is ready for I/M testing, turn the ignition key to the on position for 15 seconds without cranking the engine. If the service engine soon  indicator blinks eight times, it means that the vehicle is not ready for I/M testing; if the service engine soon  indicator stays on solid, it means that the vehicle is ready for I/M testing.

The OBD-II system is designed to check the emission control system during normal driving. A complete check may take several days. If the vehicle is not ready for I/M testing, the following driving cycle consisting of mixed city and highway driving may be performed:

15 minutes of steady driving on an expressway/highway followed by 20 minutes of stop-and-go driving with at least four 30-second idle periods.

Allow the vehicle to sit for at least eight hours without starting the engine. Then, start the engine and complete the above driving cycle. The engine must warm up to its normal operating temperature. Once started, do not turn off the engine until the above driving cycle is complete. If the vehicle is still not ready for I/M testing, the above driving cycle will have to be repeated.

### POWER STEERING FLUID

Check the power steering fluid. Refer to *scheduled maintenance information*.

1. Start the engine and let it run until it reaches normal operating temperature (the engine coolant temperature gauge indicator will be near the center of the normal area between H and C).



## Maintenance and Specifications

2. While the engine idles, turn the steering wheel left and right several times.
3. Turn the engine off.
4. Check the fluid level in the reservoir. It should be between the MIN and MAX lines. Do not add fluid if the level is in this range.

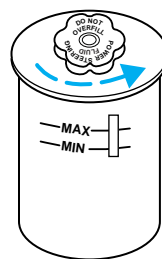

5. If the fluid is low, add fluid in small amounts, continuously checking the level until it reaches the range between the MIN and MAX lines. Be sure to put the cap back on the reservoir. Refer to *Maintenance product specifications and capacities* in this chapter for the proper fluid type.

### BRAKE FLUID

The fluid level will drop slowly as the brakes wear, and will rise when the brake components are replaced. Fluid levels below the MAX line that do not trigger the brake system warning lamp are within the normal operating range, there is no need to add fluid. If the fluid levels are outside of the normal operating range, the performance of your brake system could be compromised, seek service from your authorized dealer immediately.

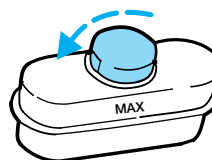

### TRANSMISSION FLUID

#### Checking automatic transmission fluid

Refer to your *scheduled maintenance information* for scheduled intervals for fluid checks and changes. Your transmission does not consume fluid. However, the fluid level should be checked if the transmission is not working properly, i.e., if the transmission slips or shifts slowly or if you notice some sign of fluid leakage.

## Maintenance and Specifications

Automatic transmission fluid expands when warmed. To obtain an accurate fluid check, drive the vehicle until it is at normal operating temperature (approximately 20 miles [30 km]). If your vehicle has been operated for an extended period at high speeds, in city traffic during hot weather or pulling a trailer, the vehicle should be turned off for about 30 minutes to allow fluid to cool before checking.

1. Drive the vehicle 20 miles (30 km) or until it reaches normal operating temperature.
2. Park the vehicle on a level surface and engage the parking brake.
3. With the parking brake engaged and your foot on the brake pedal, start the engine and move the gearshift lever through all of the gear ranges. Allow sufficient time for each gear to engage.
4. Latch the gearshift lever in P (Park) and leave the engine running.
5. Remove the dipstick, wiping it clean with a clean, dry lint free rag. If necessary, refer to *Identifying components in the engine compartment* in this chapter for the location of the dipstick.
6. Install the dipstick making sure it is fully seated in the filler tube.
7. Remove the dipstick and inspect the fluid level. The fluid should be in the designated area for normal operating temperature or ambient temperature.

### **Low fluid level**

Do not drive the vehicle if the fluid level is at the bottom of the dipstick and the ambient temperature is above 50°F (10°C).

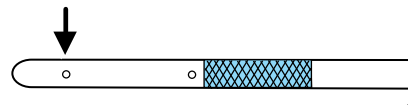

### **Correct fluid level**

The transmission fluid should be checked at normal operating temperature 150°F-170°F (66°C-77°C) on a level surface. The normal operating temperature can be reached after approximately 20 miles (30 km) of driving.

You can check the fluid without driving if the ambient temperature is above 50°F (10°C). However, if fluid is added at this time, an overfill condition could result when the vehicle reaches normal operating temperature.

## Maintenance and Specifications

The transmission fluid should be in this range if at normal operating temperature (150°F-170°F [66°C-77°C]).

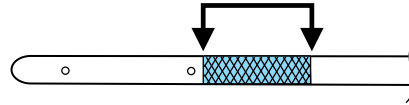

The transmission fluid should be in this range if at ambient temperature (50°F-95°F [10°C-35°C]).

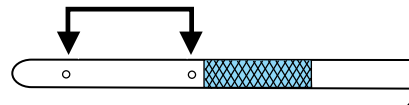

### **High fluid level**

Fluid levels above the safe range may result in transmission failure. An overfill condition of transmission fluid may cause shift and/or engagement concerns and/or possible damage.

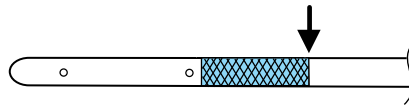

High fluid levels can be caused by an overheating condition.

### **Adjusting automatic transmission fluid levels**

Before adding any fluid, make sure the correct type is used. The type of fluid used is normally indicated on the dipstick. Refer to *Maintenance product specifications and capacities* in this chapter.

**Use of a non-approved automatic transmission fluid may cause internal transmission component damage.**

If necessary, add fluid in 1/2 pint (250 ml) increments through the filler tube until the level is correct.

If an overfill occurs, excess fluid should be removed by an authorized dealer.

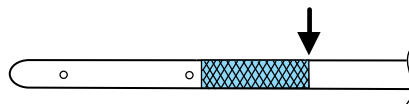

**An overfill condition of transmission fluid may cause shift and/or engagement concerns and/or possible damage.**

Do not use supplemental transmission fluid additives, treatments or cleaning agents. The use of these materials may affect transmission operation and result in damage to internal transmission components.

## Maintenance and Specifications

### AIR FILTER

Refer to *scheduled maintenance information* for the appropriate intervals for changing the air filter element.

When changing the air filter element, use only the air filter element listed. Refer to *Motorcraft® part numbers* in this chapter.



**WARNING:** To reduce the risk of vehicle damage and/or personal burn injuries do not start your engine with the air cleaner removed and do not remove it while the engine is running.

### Changing the air filter element

1. Release the clamps that secure the air filter housing cover.
2. Carefully separate the two halves of the air filter housing.
3. Remove the air filter element from the air filter housing.
4. Wipe the air filter housing and cover clean to remove any dirt or debris and to ensure good sealing.
5. Install a new air filter element. Be careful not to crimp the filter element edges between the air filter housing and cover. This could cause filter damage and allow unfiltered air to enter the engine if not properly seated.

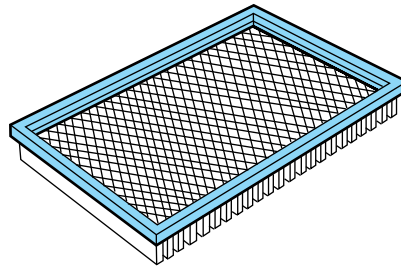

6. Replace the air filter housing cover and secure the clamps.
7. Replace the air inlet tube and secure the clamp.

**Note:** Be sure the hinge features of the air filter cover to the air filter housing are fully engaged when reassembling the air filter assembly.

**Note:** Failure to use the correct air filter element may result in severe engine damage. The customer warranty may be void for any damage to the engine if the correct air filter element is not used.

## Maintenance and Specifications

### VEHICLE STORAGE

If you plan on storing your vehicle for an extended period of time (30 days or more), refer to the following maintenance recommendations to ensure your vehicle stays in good operating condition.

All motor vehicles and their components were engineered and tested for reliable, regular driving. Long term storage under various conditions may lead to component degradation or failure unless specific precautions are taken to preserve the components.

#### *General*

- Store all vehicles in a dry, ventilated place.
- Protect from sunlight, if possible.
- If vehicles are stored outside, they require regular maintenance to protect against rust and damage.

#### *Body*

- Wash vehicle thoroughly to remove dirt, grease, oil, tar or mud from exterior surfaces, rear-wheel housing and underside of front fenders. See the *Cleaning* chapter for more information.
- Periodically wash vehicles stored in exposed locations.
- Touch-up raw or primed metal to prevent rust.
- Cover chrome and stainless steel parts with a thick coat of auto wax to prevent discoloration. Re-wax as necessary when the vehicle is washed. See the *Cleaning* chapter for more information.
- Lubricate all hood, door and trunk lid hinges, and latches with a light grade oil. See the *Cleaning* chapter for more information.
- Cover interior trim to prevent fading.
- Keep all rubber parts free from oil and solvents.

#### *Engine*

- The engine oil and filter should be changed prior to storage, as used engine oil contain contaminants that may cause engine damage.
- Start the engine every 15 days. Run at fast idle until it reaches normal operating temperature.
- With your foot on the brake, shift through all the gears while the engine is running.

#### *Fuel system*

- Fill the fuel tank with high-quality fuel until the first automatic shutoff of the fuel pump nozzle.

## Maintenance and Specifications

**Note:** During extended periods of vehicle storage (30 days or more), fuel may deteriorate due to oxidation. Add a quality gas stabilizer product to the vehicle fuel system whenever actual or expected storage periods exceed 30 days. Follow the instructions on the additive label. The vehicle should then be operated at idle speed to circulate the additive throughout the fuel system.

### *Cooling system*

- Protect against freezing temperatures.
- When removing vehicle from storage, check coolant fluid level. Confirm there are no cooling system leaks, and fluid is at the recommended level.

### *Battery*

- Check and recharge as necessary. Keep connections clean.
- If storing your vehicle for more than 30 days without recharging the battery, it may be advisable to disconnect the battery cables to ensure battery charge is maintained for quick starting.

**Note:** If battery cables are disconnected, it will be necessary to reset memory features.

### *Brakes*

- Make sure brakes and parking brake are fully released.

### *Tires*

- Maintain recommended air pressure.

### *Miscellaneous*

- Make sure all linkages, cables, levers and pins under vehicle are covered with grease to prevent rust.
- Move vehicles at least 25 feet (8 m) every 15 days to lubricate working parts and prevent corrosion.

### **Removing vehicle from storage**

When your vehicle is ready to come out of storage, do the following:

- Wash your vehicle to remove any dirt or grease film build-up on window surfaces.
- Check windshield wipers for any deterioration.
- Check under the hood for any foreign material that may have collected during storage (mice/squirrel nests).
- Check the exhaust for any foreign material that may have collected during storage.

## Maintenance and Specifications

- Check tire pressures and set tire inflation per the Tire Label.
- Check brake pedal operation. Drive the vehicle 15 ft (4.5 meters) back and forth to remove rust build-up.
- Check fluid levels (including coolant, oil and gas) to make sure there are no leaks, and fluids are at recommended levels.
- If the battery was removed, clean the battery cable ends and inspect.

If you have any concerns or issues, contact your authorized dealer.

### MOTORCRAFT PART NUMBERS

Component	4.6L V8 engine
Air filter element	FA-1783
Fuel filter	FG-1114
Battery-standard	BXT-65-650
Battery-heavy duty	BXT-65-750
Oil filter	FL-820-S
Oil filter (with oil cooler )	FL-910
Spark plugs	<sup>1</sup>

<sup>1</sup>For spark plug replacement, see your authorized dealer. Refer to *scheduled maintenance information* for the appropriate intervals for changing the spark plugs.

**Replace the spark plugs with ones that meet Ford material and design specifications for your vehicle, such as Motorcraft® or equivalent replacement parts. The customer warranty may be void for any damage to the engine if such spark plugs are not used.**

## Maintenance and Specifications

### MAINTENANCE PRODUCT SPECIFICATIONS AND CAPACITIES

Item	Capacity	Ford part name or equivalent	Ford part number / Ford specification
Brake fluid	Between MIN and MAX on reservoir	Motorcraft® High Performance DOT 3 Motor Vehicle Brake Fluid	PM-1-C / WSS-M6C62-A or WSS-M6C65-A1
Door weatherstrips	—	Silicone Spray Lubricant	XL-6 / ESR-M13P4-A
Engine coolant	18.6 quarts (17.6L)	Motorcraft® Premium Gold Engine Coolant (yellow-colored) <sup>1</sup>	VC-7-B (US) / CVC-7-B (Canada) WSS-M97B51-A1 <sup>1</sup>
Engine oil	6.0 quarts (5.7L)	<ul style="list-style-type: none"> <li>• Motorcraft® SAE 5W-20 Premium Synthetic Blend Motor Oil (US)</li> <li>• Motorcraft® SAE 5W20 Full Synthetic Motor Oil (US)</li> <li>• Motorcraft® SAE 5W-20 Super Premium Motor Oil (Canada)</li> <li>• Motorcraft® SAE 5W-20 Synthetic Motor Oil (Canada)<sup>2</sup></li> </ul>	<ul style="list-style-type: none"> <li>• XO-5W20-QSP (US)</li> <li>• XO-5W20-QFS (US)</li> <li>• CXO-5W20-LSP12 (Canada)</li> <li>• CXO-5W20-LFS12 (Canada) / WSS-M2C930-A with API Certification Mark</li> </ul>



## Maintenance and Specifications

Item	Capacity	Ford part name or equivalent	Ford part number / Ford specification
Hinges, latches, striker plates, fuel filler door hinge and seat tracks	—	Multi-Purpose Grease (Lithium grease)	XG-4 or XL-5 or equivalent / ESB-M1C93-B
Lock cylinders	—	Motorcraft® Penetrating and Lock Lubricant	XL-1 / None
Power steering fluid	Between MIN and MAX on reservoir	Motorcraft® Motorcraft® V ATF	XT-5-QM / MERCON® V
Automatic transmission fluid (4R75E)	13.9 quarts (13.2L) <sup>3</sup>	Motorcraft® MERCON® LV ATF <sup>4</sup>	XT-10-QLV / MERCON® LV
Rear axle fluid <sup>5</sup>	5.0 pints (2.4L) <sup>6,7</sup>	Motorcraft® SAE 80W-90 Premium Rear Axle Lubricant	XY-80W90-QL / WSP-M2C197-A
Rear axle fluid (Police) <sup>5</sup>		Motorcraft® SAE 75W-140 Synthetic Rear Axle Lubricant	XY-75W140-QL / WSL-M2C192-A

<https://www.MyCarManual.com>

## Maintenance and Specifications

Item	Capacity	Ford part name or equivalent	Ford part number / Ford specification
Windshield washer fluid	Fill as required	Motorcraft® Premium Windshield Washer Concentrate (US) Premium Quality Windshield Washer Fluid (Canada)	ZC-32-A (US) CXC-37-(A, B, D, and F) (Canada) / WSB-M8B16-A2/- -
Fuel tank	19.0 gallons (71.9L)	—	—

<sup>1</sup>Add the coolant type originally equipped in your vehicle.

<sup>2</sup>Use of synthetic or synthetic blend motor oil is not mandatory. Engine oil need only meet the requirements of Ford specification WSS-M2C930-A and the API Certification mark.

<sup>3</sup>Indicates only approximate dry-fill capacity. Some applications may vary based on cooler size and if equipped with an in-tank cooler. The amount of transmission fluid and fluid level should be set by the indication on the dipstick's normal operating range. Police or Handling Package refill capacity- 12.8 quarts (12.1L).

<sup>4</sup>Use of any fluid other than the recommended fluid may cause transmission damage. Refer to *scheduled maintenance information* to determine the correct service interval.

<sup>5</sup>Rear axles are considered lubricated for life when the vehicle is used for normal service. For severe duty requirements, see *Exceptions and/or Special Operating Conditions* in *scheduled maintenance information*.

<sup>6</sup>Service refill capacities are determined by filling the rear axle 1/4 inch to 9/16 inch (6 mm to 14 mm) below the bottom of the filler hole.

<sup>7</sup>Add 4 oz. (118 ml) of Additive Friction Modifier XL-3 or equivalent meeting Ford specification EST-M2C118-A for complete refill of Traction-Lok rear axles.

## Maintenance and Specifications

### ENGINE DATA

Engine	4.6L V8 engine	4.6L FFV V8 engine
Cubic inches	281	281
Required fuel	Minimum 87 octane	Minimum 87 octane or Ethanol (E85)
Firing order	1-3-7-2-6-5-4-8	1-3-7-2-6-5-4-8
Ignition system	Coil on plug	Coil on plug
Spark plug gap	0.052–0.056 inch (1.32–1.42 mm)	0.041–0.047 inch (1.04–1.20 mm)
Compression ratio	9.4:1	9.4:1

### Engine drivebelt routing

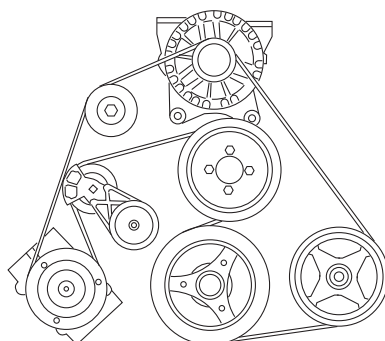

## Maintenance and Specifications

### IDENTIFYING YOUR VEHICLE

#### Safety Compliance Certification Label

The National Highway Traffic Safety Administration Regulations require that a Safety Compliance Certification Label be affixed to a vehicle and prescribe where the Safety Compliance Certification Label may be located. The Safety Compliance Certification Label is located on the structure (B-Pillar) by the trailing edge of the driver's door or the edge of the driver's door.

MFD. BY FORD MOTOR CO.						
DATE: XX/XX	GVWR: XXXXLB/ XXXXXKG					
FRONT GAWR: XXXXL	REAR GAWR: XXXXLB					
XXXXKG	WITH	XXXXKG	WITH			
XXXX/XXXXXX	TIRES:	XXXX/XXXXXX	TIRES			
XXXX.XX	RIMS:	XXXX.XX	RIMS			
AT XXX kPa/XX	PSI COLD	AT XXX kPa/XX	PSI COLD			
THIS VEHICLE CONFORMS TO ALL APPLICABLE FEDERAL MOTOR VEHICLE SAFETY STANDARDS IN EFFECT ON THE DATE OF MANUFACTURE SHOWN ABOVE.						
VIN: XXXXXXXXXXXXXXXX					XXXXX	
TYPE: XXX					XXXXX	
						
EXT PNT: XX	RC: XX		DSO:			
WB <sup>1</sup>	INT TR	TP/PS	TR	AXLE	TR SPR	XXXXX
XXX	XX	X	XX	X	XX	XXXX
XXXXXXXXXXXXXXXX XXXX XXXX-XXXXXX-XX						

#### Vehicle identification number (VIN)

The vehicle identification number is located on the driver side instrument panel.

Please note that in the graphic, XXXX is representative of your vehicle identification number.

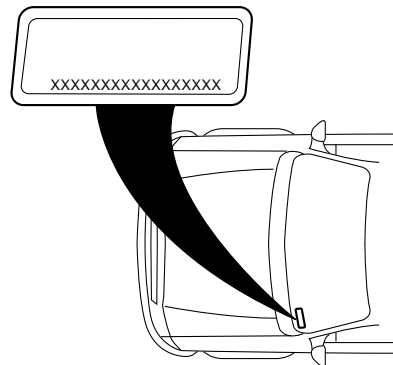

## Maintenance and Specifications

The Vehicle Identification Number (VIN) contains the following information:

1. World manufacturer identifier
2. Brake system / Gross Vehicle Weight Rating (GVWR) / Restraint Devices and their location
3. Make, vehicle line, series, body type
4. Engine type
5. Check digit
6. Model year
7. Assembly plant
8. Production sequence number

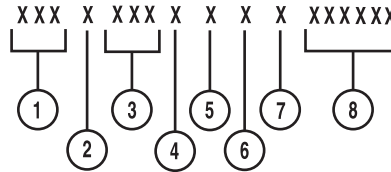

### TRANSMISSION CODE DESIGNATIONS

You can find a transmission code on the Safety Compliance Certification Label. The following table tells you which transmission each code represents.

<b>MFD. BY FORD MOTOR CO.</b>	
DATE: XX/XX	GVWR: XXXXLB/ XXXXKKG
FRONT GAWR: XXXXL	REAR GAWR: XXXXLB
XXXXKG	WITH XXXXKG
XXXX/XXXXXX	TIRES: XXXX/XXXXXX
XXXX.XX	RIMS: XXXX.XX
AT XXX kPa/XX	PSI COLD AT XXX kPa/XX
THIS VEHICLE CONFORMS TO ALL APPLICABLE FEDERAL MOTOR VEHICLE SAFETY STANDARDS IN EFFECT ON THE DATE OF MANUFACTURE SHOWN ABOVE.	
VIN: XXXXXXXXXXXXXXXXX	XXXXX
TYPE: XXX	XXXXX
XXXXXXXXXXXXXXXXXX XXX XXXX-XXXXXXXX-XX	
EXT PNT: XX	RC: XX
WB: INT TR TP/PS R AXLE TR SPR XXXX	
XXX XX X XX X XX XXX	

Description	Code
Four-speed automatic overdrive (4R75E)	Q

## Crown Victoria Severe Duty

This information is intended to aid the operators of police or fleet vehicles (used in severe duty, high mileage operations) in understanding the required maintenance services for such vehicles. It covers maintenance services for vehicles equipped with Heavy Duty packages. However, other vehicles operated under the conditions listed in this supplement are also considered “severe service” vehicles and should be serviced and maintained as described in this chapter and the *Scheduled Maintenance Guide* chapter.

### CONTACT US

Ford Fleet Hotline - The Ford Fleet Hotline provides police and fleet customers with direct access to Ford Motor Company for fleet sales or service information. The hotline number is (800) 34-FLEET.

Ford Fleet website - Additionally, Ford maintains a website for police and other fleet vehicles. The Ford Fleet website is located at [www.fleet.ford.com](http://www.fleet.ford.com).

Police and fleet vehicles are manufactured with certain heavy duty parts that are designed specifically for the varying demands and unique requirements under which they are operated.

**Note:** As the police proportion of the Crown Victoria market continues to increase, some of these heavy duty components have become standard across the Crown Victoria line to reduce parts and manufacturing complexity.

Components that are part of the option packages are listed below and on the following pages with a brief outline of their major features and their contribution to overall vehicle performance, handling and usage.

Failure to maintain your vehicle(s) properly may restrict your warranty coverage, reduce vehicle performance and operational capabilities and adversely affect driver-passenger safety. The severe duty maintenance intervals are listed in the *Scheduled Maintenance Guide* chapter.

The descriptions, specifications and material described in this publication were in effect at the time the publication was approved for printing. Ford Motor Company reserves the right to discontinue models at any time, or change specifications, design or testing procedures without notice and without incurring obligation.

### TRANSMISSION

The police vehicle has a unique high-performance powertrain including transmission and an aluminum driveshaft, which is designed for maximum vehicle performance. Due to the nature of this powertrain, some powertrain noise may be present.

270

<https://www.MyCarManual.com>

## Crown Victoria Severe Duty

Driving in the overdrive cancel mode for prolonged periods at high speeds will deteriorate performance and may cause extensive engine damage.

Crown Victoria police vehicles are designed to operate in the **D** (Overdrive) gear selector position while in pursuit. Optimum performance will be obtained in **D** (Overdrive). Operation in the overdrive cancel mode should only be used in situations noted in this publication.



**WARNING:** Under no circumstances should the aluminum driveshaft be replaced with a steel driveshaft. Doing so will adversely affect vehicle operation which could lead to personal injury.

### POWERTRAIN OVERSPEED PROTECTION

The powertrain control module (PCM) includes logic to electronically prevent powertrain overspeed in any transmission selector position.

### IDLE METER

Your vehicle may be equipped with an idle meter to indicate how much time the vehicle is idling in P (Park) or N (Neutral). The meter is incorporated with the vehicle odometer. Pressing the odometer-reset button once will display the trip odometer (miles followed by a “T” for trip odometer). Pressing the odometer-reset button a second time will display the idle meter (hours followed by an “h” for hours). The idle meter only accumulates time when the vehicle is in P (Park) or N (Neutral). Displayed time is cumulative for the vehicle. It cannot be reset to zero.

Police/Fleet vehicles often experience long periods of idling, during which engine oil will continue to break down but mileage is not accumulated on the odometer.

To assist fleet managers in maintaining proper oil change intervals, the idle meter will help determine when an oil change is required. For every hour that the vehicle idles, it has accumulated the equivalent of approximately 33 miles (53 km) of driving. Using the combination of the vehicle odometer and idle meter allows the fleet manager to better determine when the oil needs to be changed.

**Example:** When the odometer has accumulated 3,000 miles (4,828 km) and the idle meter shows 61 hours, a 5,000 mile (8047 km) oil change interval will have been reached: 3,000 road miles + (61 idle hours x 33 miles/idle hour) = 5,013 miles. In metric units this calculation would be 4,828 kilometers + (61 idle hours x 53 km/idle hour) = 8,061 km.

## Crown Victoria Severe Duty

### REAR AXLE

#### Axle break-in – Police and middle eastern countries only

Rear axles in vehicles destined for use by police or in middle eastern countries are equipped with a synthetic lubricant. Do not drive over 100 mph (160 km/h) for the first 1,000 miles (1,600 km) to allow axle components to wear in. Additionally, only synthetic lubricant as specified below should be used when maintenance is performed on the rear axle.

#### Lubricant specifications

Item	Ford part name	Ford part number	Ford specification
Rear axle lubricant	Motorcraft SAE 75W-140 High Performance Synthetic Rear Axle Lubricant	XY-75W140-QL	WSL-M2C192-A

### ELECTRICAL

#### Battery - police

The Motorcraft® maintenance-free battery normally does not require additional water during its life. However, for severe service usage or in high temperature climates, the electrolyte level should be checked at least every five months or 5,000 miles (8,000 km). If the electrolyte level is below the level indicator in any cell, add enough pure water to bring the level up to the indicator. Never add electrolyte (battery acid) to the battery as this could shorten battery life.

#### Battery - long term storage

Make sure that the battery is fully charged before putting the vehicle in storage. Disconnect the negative cable if it will be stored for an extended period of time.

If the battery is discharged, allow it to warm to a moderate temperature, such as 60°F (16°C), and use a battery charger rather than the vehicles charging system to bring the battery back to full charge. Use a battery charger designed for commercial use such as the Rotunda GR-1. Never let a fully discharged battery remain discharged for a long period of time. Extended storage in a discharge state can cause irrecoverable damage to the internal components or cracking of the container. As a battery approaches a discharged state it becomes easier for the electrolyte to freeze. If it freezes and expands it may crack the battery case.



## Crown Victoria Severe Duty

### Alternator - police

The high-output alternator provides 200 amperes of current to support the high power requirements of modern police equipment. Output at idle is approximately 130 amperes. Current demand by both the vehicle and all energized police equipment in excess of this amount during vehicle idling will place the electrical system into a discharge condition. Electrical power management systems should be applied if necessary to avoid discharging the battery.

### Power distribution connector

Power for aftermarket equipment can be obtained from the power distribution connector located under the glove compartment. This connector contains several fused power feeds and inputs available for the addition of accessories. The following tables show the circuits available for equipment.

Police			
Pin	Function	Gauge	Color
1	5A Start	18	Red/Black
2	Vehicle speed signal	18	Gray/Black
3	Battery saver	18	Dark green/Light green
4	20A Battery	14	Light green
5	15A Battery	18	Orange/Light green
6	50A Battery	10	Tan/Yellow
7	20A Run/Acc	14	Pink
8	20A Battery	14	Light Blue/White
9	20A Run/Acc	14	Tan
10	Hazard out	18	Black/Yellow
11	50A Battery	10	Red/White
12	Hazard In	18	Gray/White

Taxi			
Pin	Function	Gauge	Color
1	Not used	—	—
2	Vehicle speed signal	20	Gray/Black
3	Battery saver	18	Light green/Orange
4	50A Battery	10	Light green
5	Not used	—	—

## Crown Victoria Severe Duty

Taxi			
Pin	Function	Gauge	Color
6	50A Battery	10	Tan/Yellow
7	20A Run/Acc	12	White/Pink
8	10A Run/Acc	14	Light Blue/White
9	50A Battery	10	Yellow
10	Not used	—	—
11	50A Battery	10	Red/White
12	10A Run/Acc	14	Gray/White

The mating connector is provided on the end of the power distribution connector. The vehicle modifier can either purchase pins for the mating connector and install them on the wires before they are inserted into the connector, thereby avoiding any splicing, or purchase an optional power pigtail for the interface. The power pigtail (P/N 14A411) plugs into the power distribution connector and provides blunt cut wires ready for splicing by the vehicle modifier.

See the *Police Interceptor Modifier Guide* for more details.

### Rear power point - police

The rear power point is a battery access port for police auxiliary equipment mounted in the trunk. It is capable of supplying 80 amps of battery power. The front power distribution box (PDB) contains two 50 amp fuses, which protect the power point. Battery access is via two studs contained in an enclosure, mounted in the trunk, on the right side fender support. The terminal with the red wires is the battery positive, and the terminal with the black wire is the ground. Remove both fuses in the front PDB before removing the cover to the rear power point. Ensure load devices can be turned off, and are switched off when reinserting fuses.



**WARNING:** Under no circumstance should the rear power point cover be removed without first pulling the two fuses in the front power distribution box. Removing cover without pulling fuses could result in an electrical hazard, and result in personal injury. Shut off load devices before inserting fuses.

## Crown Victoria Severe Duty

### Headlight flashers (wig-wags) - police

An interfacing connector is provided on the headlight circuit for use of the headlights as alternating flashers (wig-wags). The connector is located in front of the radiator. A protective cap is attached to prevent contaminants from entering the connector when a wig-wag module is not installed. When installing a headlight flasher (wig-wag) module, remove the connector and tape it to the wigwag module harness. This will ensure that the cap is available to be reattached if the wig-wag module is removed. For additional information, refer to the *Crown Victoria Wiring Diagram Manual*.

If your vehicle is equipped with one of the optional Police Interceptor Equipment packages, the connector will already be used by the supplied wig-wag module that comes with the option package.

**Note:** Use of the wig-wag feature overrides normal operation of the high beam headlights, including flash-to-pass. However, the low beam headlights will remain on and unaffected.

### HEAVY DUTY SUSPENSION - POLICE

This option includes certain heavy duty components that contribute to the vehicle's stability and road handling capability under extremes of operation. The police vehicle has a heavy duty steering gear, extra control shock absorbers and heavy duty front and rear stabilizer bars.

### COOLERS

It is strongly recommended that auxiliary devices such as lights not be installed at the grille. Such devices will reduce airflow through the grille and could potentially impact the cooling system performance.

#### Oil cooler - police

The 4.6L engine has an engine oil cooler to maintain engine oil temperatures.

#### Engine and transmission coolers

External transmission and power steering coolers are located behind the grille and in front of the radiator. It is strongly recommended that auxiliary devices such as lights and sirens not be installed in the air path of these coolers as they will impact cooling system performance.

## Crown Victoria Severe Duty

### WHEELS/TIRES/BRAKES

#### Wheel rims - police

To withstand the demands placed on vehicles driven under heavy duty service conditions, Ford Motor Company installs heavy duty steel wheels.

#### Tires - police

Tires (including the spare) are speed-rated radials for police use. Use only the recommended tire size and speed ratings.

In regions with snow and ice during the winter months, installation of snow tires may be desirable. Snow tires will usually exhibit a drop in dry pavement handling, but many show an increase in snow and ice traction. When snow tires are used, they should be installed on all four wheels, never on the drive wheels only.

#### Tires - long term storage

Most high performance tires are made with a nylon overlay.

As such, the following steps should be taken to avoid flatspotting when the vehicles are not used for a period of time.

- Fleets should store the vehicles with 44 psi (303 kPa) in the tires.
- If the vehicle is stored for periods longer than 30 days, it should be moved several feet at least once during each 30-day period, so that a different portion of the tread contacts the ground.
- Tire pressure should be reduced to the recommended pressure shown on the vehicle certification label before the vehicle is placed back into service.

#### Training the tire pressure monitoring system (TPMS)

All Crown Victorias are equipped with a tire pressure monitoring system (TPMS) that illuminates a low tire pressure warning light on the instrument cluster when one or more of your tires is significantly under-inflated.

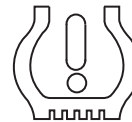

## Crown Victoria Severe Duty

Each road tire, as well as the spare, is equipped with a tire pressure sensor fastened to the inside of the rim, opposite (180 degrees) from the valve stem. The signal from each transmitter is digitally unique to avoid interference from transmitters on other nearby vehicles.

**Note:** The spare has a TPMS sensor, but is not programmed to the module.

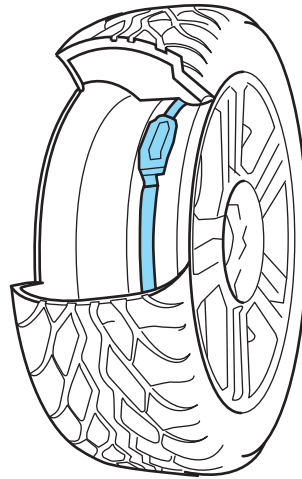

### **Changing tires with a TPMS**

Care should be taken avoid damaging the sensor and band during mounting or dismounting. Please refer to the *Crown Victoria Workshop Manual* for the complete mount and dismount procedure. This is critical, as the procedure is different from previous model years due to the introduction of the TPMS.

**When a new tire/wheel is installed**, the TPMS sensor located in the new tire/wheel needs to be “trained” to the vehicle.

**TPMS training tools**, such as P/N 8C2Z-1A203-A, can be purchased from any Ford dealer for use by the driver or shop technician for training the system after maintenance has been performed that requires system training. The Tire Pressure Monitor Activation Tool, P/N 204-363, has more functionality and is designed primarily for shop use. For either tool, follow the training instructions as outlined below.

**Note:** This procedure is also included in the *Crown Victoria Workshop Manual*.

### **TPMS reset tips:**

- To reduce the chances of interference from another vehicle, the TPMS reset procedure should be performed at least three feet (one meter) away from another Ford Motor Company vehicle undergoing the TPMS reset procedure at the same time.

## Crown Victoria Severe Duty

- Do not wait more than two minutes between resetting each tire sensor or the system will time-out and the entire procedure will have to be repeated on all four wheels.
- A double horn chirp indicates the need to repeat the procedure.

### **TPMS reset procedure**

**Note:** It is recommended that you read the entire procedure before attempting.

**Note:** To enter the reset mode, Steps 1–6 **MUST** be completed within 60 seconds.

1. Place the ignition in the off position and keep the key in the ignition.
2. Press and release the brake pedal.

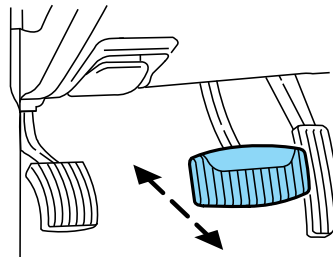

3. Cycle the ignition from off to on three times ending in the on position - **DO NOT** start the engine.

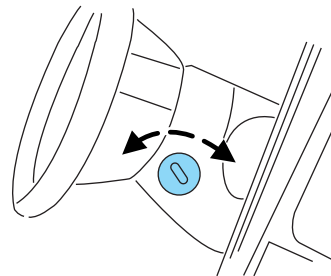

## Crown Victoria Severe Duty

4. Press and hold the brake pedal for two seconds, then release.

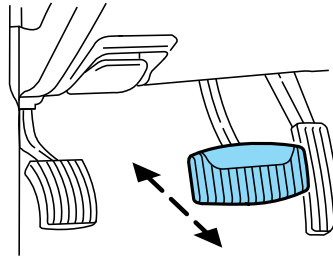

5. Turn the ignition to off - **DO NOT** remove the key.

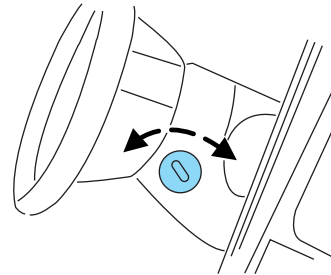

6. Cycle the ignition from off to on three times ending in on - **DO NOT** start the engine.

If the reset mode has been entered successfully, the horn will sound once, and the TPMS indicator  will flash.

If after repeated attempts to enter the reset mode, the horn does not sound, and the TPMS indicator  does not flash, seek service from your authorized dealer.

## Crown Victoria Severe Duty

7. Train the TPMS sensors in the tires using the following TPMS reset sequence starting with the **left front tire** in the following clockwise order:

- Left front (Driver's side front tire)
- Right front (Passenger's side front tire)
- Right rear (Passenger's side rear tire)
- Left rear (Driver's side rear tire)

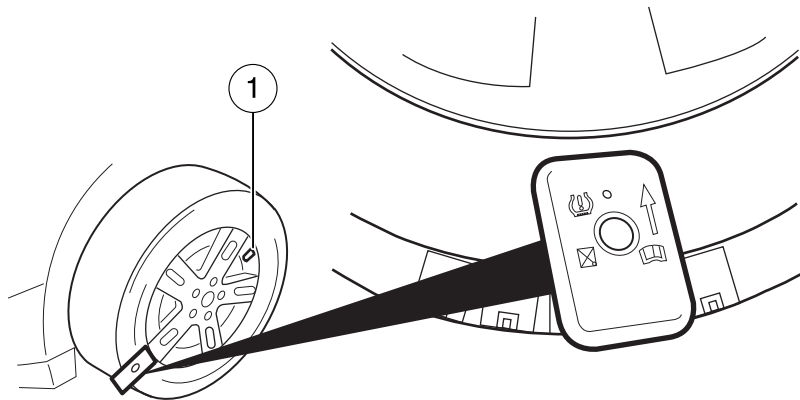

8. **Left front tire:** Place the TPMS reset tool against the left front tire where the tire meets the rim, opposite from the valve stem (1) as shown. This is where the sensor is located inside the rim.

**Both tools, the TPMS training tool (part number 8C2Z-1A203-A) or the Tire Pressure Monitor Activation Tool (part number 204-363), must be held against the tire sidewall opposite the valve stem as illustrated. For the TPMS training tool, the device should be held as illustrated, with the arrow on the tool pointing towards the rim; do not use the tool with the arrow pointing away from the rim as it may not activate the sensor.**

9. Press and release the activation button while holding either tool to the side wall until the horn sounds. The horn will sound once within approximately 10 seconds to indicate the process was successful.

**Note:**

- If a double horn chirp is heard, repeat the procedure. If a single horn chirp is not heard, move the vehicle to rotate the wheels at least a  $\frac{1}{4}$ -turn and repeat the procedure starting with Step 1.



## Crown Victoria Severe Duty

- If the horn does not sound while attempting to reset any wheel, seek service from your authorized dealer.

10. Perform Steps 8 and 9 on the right front tire, right rear tire and finally the left rear tire. Training is complete after the horn sounds for the last tire trained (left rear tire).

Turn the ignition to off. If two short horn beeps are heard, the reset procedure was unsuccessful and must be repeated.

If after repeating the procedure and two short beeps are heard when the ignition is turned to off, seek assistance from your authorized dealer.

### **Brakes - police**

The police vehicle is equipped with heavy duty front disc brake pads to meet the varying demands of different police service for fade resistance and other performance requirements.

The police vehicle has standard anti-lock brakes and may be equipped with traction control.

### ***Brake fluid maintenance***

Police pursuits involving hard braking result in very high temperatures in the brake system, including the brake fluid. Over time, repeated exposure to high brake temperatures can degrade brake fluid, potentially reducing its boiling point. A lower boiling point could cause long brake pedal travel and a loss of braking confidence during subsequent pursuit driving. Ford recommends that police fleets replace the brake fluid at every brake pad service interval. Brake fluid may be replaced more frequently on vehicles involved in frequent high-speed pursuits with heavy brake usage.

## **INTERIOR**

### **Heavy duty seats - police**

The front seat assemblies, including the seat adjustment mechanisms and supports, are ruggedly designed and ensure working comfort. An anti-stab plate is integrated into the seat back to reduce the risk of officer injury. An adjustable power lumbar system is standard on the driver's seat.

### **Seat belt extenders**

Some police departments have begun employing the use of seat belt extenders to make the practice of buckling and unbuckling seat belts easier for officers wearing hip mounted radios, side arms, etc.

## Crown Victoria Severe Duty

Seat belt extenders should never be worn when the lap strap will not adjust snugly on the hips and/or when the intersection of the lap belt and shoulder belt straps (measured along the lap strap) is less than six (6) inches (15 cm) from an imaginary center line of the occupant's body.



**WARNING:** Do not use extensions to change the fit of the shoulder belt across the torso.

### Calibrated speedometer - police

Deviations from true road speeds are minimized by a calibrated speedometer head which gives both miles-per-hour (0–140 mph) and kilometer-per-hour (0–222 km/h) readings. The speedometer head assembly accuracy is  $\pm 2$  mph ( $\pm 3$  km/h) over the entire range (at 70°F [21°C]). The “certified calibration” applies to the head assembly only and does not apply to the indicated speed of the system, which is affected by variations in vehicle loading, tire inflation pressures, tire rolling radii and driveline ratios.

### Red/White map light - police (if equipped)

The police vehicle may be equipped with a red/white map light located in the headliner between the driver and front seat passenger. A three-position switch provides either white or night-vision red options. When the rocker switch is in the center position, the lamp is off. Pressing the left side (white dot) makes the lamp operate in the white light mode. Pressing the right side (red dot) makes the lamp operate in the night-vision red mode.

### Mobile communication systems

The Federal Communications Commission regulates the use of mobile communication systems (such as two-way radios, telephones and theft alarms) that are equipped with radio transmitters. If you install this equipment in your vehicle, you should comply with those rules and a qualified technician should install the equipment. Ford Motor Company vehicles are in compliance with FCC regulations (CFR 47 Part 15) and SAE J551d for radiated electromagnetic emissions.

Mobile communication systems may harm the operation of your vehicle, particularly if they are not properly designed for automotive use or not properly installed. For example, when operated, such systems may cause the engine to stumble or stall and may affect 4R70W transmission operation. In addition, such systems may themselves be damaged or their operation affected by operating your vehicle. (Citizen band [CB]

282

<https://www.MyCarManual.com>

## Crown Victoria Severe Duty

transceivers, garage door openers and other transmitters whose power output is 5 watts or less will not ordinarily affect your vehicle's operation.)

Because we have no control over the installation, design or manufacture of such systems, Ford cannot assume responsibility for any adverse effects or damage that may result if you use this equipment.

Malfunction of aftermarket electronic equipment should be resolved by the equipment manufacturer.

### Aftermarket equipment installation

Ford has developed a *Police Interceptor Modifier Guide* to assist the vehicle modifier in safely installing police equipment into the vehicle. The guide provides detailed information on the location of key vehicle components that must be untouched and warnings for other areas where caution must be exercised. The Modifier Guide is available for downloading, free of charge, from [www.fleet.ford.com](http://www.fleet.ford.com).

When installing aftermarket equipment, avoid using fasteners that are too long for the application or are in an area which might damage vehicle components, including wiring, brake lines, fuel tank and lines, powertrain components, exhaust system and suspension.

Also, do not make electrical connections to vehicle electrical systems not specifically designed for aftermarket equipment installations. Refer to the "Wiring Diagram Manual" for electrical system information.

Do not install any components into the powertrain control module (PCM) or PCM harness. Connecting into this system may affect engine and transmission operation.

As an example: connection of aftermarket electrical equipment into the brake light circuit or any other circuit which is connected to the PCM, anti-lock brake computer, airbag system or any other vehicle system which will cause vehicle malfunction.



**WARNING:** Contact during a crash with aftermarket equipment in a vehicle can result in a personal injury.



**WARNING:** Installation of prisoner barriers may increase the risk of injury to front seat occupants if the vehicle is impacted from the rear at high speeds. This risk should be balanced, by the law enforcement agency, against the risk of injury to the Officer associated with prisoner transport.

## Crown Victoria Severe Duty

### Trunk Pack™ and trunk loading

 **WARNING:** Ford recommends that police equipment be both secured and laterally aligned. Hard, stiff or sharp objects, especially when not secured or properly located, pose a risk to the fuel tank and back seat occupants in the event of a high speed rear impact. After-market organizers that do not adequately deform in rear-impacts can themselves become injury-producing objects. When locating, securing and mounting police equipment, please review the "Trunk Equipment Mounting Guide," available on the [www.cvpi.com](http://www.cvpi.com) website, which provides recommended fastener mounting types and locations.

 **WARNING:** Following the trunk packing considerations, also on the [www.fleet.ford.com](http://www.fleet.ford.com) website, is the most meaningful method of reducing risk. If your department practice is inconsistent with the Trunk Packing Considerations, then Ford suggests that you consider purchasing an optional drop-in Trunk Pack™ to further reduce the risk of injury resulting from police equipment pushing forward into the back seat and/or fuel tank in the event of a high-speed rear impact. The Trunk Pack™ provides more flexibility to officers transporting police equipment than the trunk packing considerations.

To improve trunk packing by police agencies, Ford has made the following items available:

- Trunk Pack™ – a drop-in box with a tough plastic shell made of high density Polyethylene (HDPE). It both aligns police equipment laterally in the trunk and utilizes a puncture resistant lining on the forward side of the box to reduce the risk of police equipment penetrating into the fuel tank and/or back seat in high-speed rear impacts.
- Trunk Equipment Mounting Guide – an outline pattern with recommended fastener mounting locations in the trunk. The guide can be found in the *Police Interceptor Modifier Guide* and on the Internet at [www.fleet.ford.com](http://www.fleet.ford.com).
- Trunk packing considerations – the following guidelines are offered to reduce the risk of unique police equipment items pushing through the fuel tank and/or back seat (see our [www.fleet.ford.com](http://www.fleet.ford.com) website for more details).

### Trunk packing considerations

A slogan has been developed to increase police agency awareness of the importance of trunk packing.

284

<https://www.MyCarManual.com>

## Crown Victoria Severe Duty

### 'LOAD SAFE'

**L-Lateral**

**S-Soft**

**O-Orientation**

**A-and**

**A-and**

**F-Fixed**

**D-Direction**

**E-Equipment**

### **Equipment categories and placement**

It is recognized that a wide variety of equipment is carried in the trunks of police vehicles as noted above. This section addresses the inherent risks of various types of equipment in the event of a high-speed rear impact.

This information is divided into three categories:

- Carrying not recommended
- Carry with caution
- Low risk items



**WARNING: Carrying not recommended – The following items have been observed in police vehicles and should not be transported in a vehicle trunk** – containers with gasoline, loose ammunition, loose flares, loose fire extinguisher(s), loose 4-point lug wrench, loose crowbars, loose axes and other loose equipment with potential puncture capability in high speed rear end collisions.

**Carry with caution** – These items will require special packing or mounting consideration and possibly use of the Trunk Pack™ as an additional level of safety. Examples include (with proposed orientation): fire extinguisher (fixed), lug wrench 4-point (fixed - vertical), rototape measuring wheel (fixed - vertical), safety flares (lateral orientation – in a container), stop stick (lateral - mount on deck lid inner panel), shovel (lateral - place at rear of trunk), shotgun and rifle (lateral - store in case), baton (lateral - place at rear of trunk), ammunition (container). Flares should be placed in a protective storage container (preferably soft sided plastic). Flares with spikes attached should be laterally oriented in the trunk area.

1. **Spare tire special considerations** – The safest location for the spare tire, jack and lug wrench is the production location on the forward package shelf above the rear axle. If unable to mount there, the next safest location for the spare tire is mounted vertically inside the Trunk Pack™ using the J-bolt attachment device provided with the Trunk Pack™. The jack and lug wrench should be stored in the rearward compartment of the Trunk Pack™.

## Crown Victoria Severe Duty

2. **Electronic Equipment** – The safest location for the electronic equipment is on the trunk forward package shelf. Some equipment can be mounted in the side shelf areas, but it must not protrude into the fuel tank area in a crash (noted in Trunk Equipment Mounting Guide). The optional Complete Police Prep Package is available to facilitate packaging of electronic components with a sliding tray for the forward package shelf and side compartments in the right and left shelf area. All equipment should be located and mounted using the "Trunk Equipment Mounting Guide" for proper positioning of fasteners. This guide can be accessed on the [www.fleet.ford.com](http://www.fleet.ford.com) website. The sliding tray can also be used, depending on size, to properly store parts with rigid and sharp edges.

3. **Ammunition** – The safest location for ammunition is the forward package shelf and on the side shelves. It is recommended that a plastic storage container be utilized and mounted using the "Trunk Mounting Equipment Guide" for proper fastener locations. It is also recommended that ammunition remain in the purchased container and be placed in a safe storage container.

**Low risk items** – These items are soft in feel and pose a low risk of trunk wall, rear seat area, and fuel tank puncture. Examples are: a soft camera case, biohazard kit in plastic boxes, gloves, safety rope, tow strap, traffic cones & sleeves, rain gear, riot gear (soft), emergency blankets, bullet resistant vest, tie straps, cloth tape, garment bags, first responder kit, Res-Q-Flo mask (placed in garment bag), fuses (plastic container), briefcase, notebooks, spray bottles, helmet, and jumper cables. It is not essential but recommended that the Trunk Pack™ can be considered for organization of low risk items, especially if mixed with "Carry With Caution" items.

### BODY

#### Fire suppression system (if equipped)

Your vehicle may be equipped with an optional fire suppression system. The fire suppression system is designed to help reduce the risk of injury in high-speed rear impacts. The fire suppression system deploys chemicals designed to slow the spread of fire or potentially extinguish a fire, thereby providing more time for occupants to escape from a crashed vehicle.

## Crown Victoria Severe Duty

The fire suppression system is mounted beneath the vehicle and attached to the frame above and forward of the fuel tank and rear axle. The fire system control module is mounted inside the passenger compartment centered underneath the rear seat cushion. The system is designed to deploy automatically after sensing a high-speed/high-energy rear end impact.

There is a covered manual activation switch mounted in a console on the headliner between the visors that can be used by vehicle occupants to manually deploy the system. The fire suppression system can be manually deployed any time the key or engine is turned on by pushing the button underneath the cover. The button can be accessed three ways:

1. Pushing on the cover will release the cover latch, allowing the door to swing open and expose the button;
2. The cover can be pulled open;
3. A firm strike on the cover (about 20 lb–ft [89 N•m] of force) will deploy the system any time the key or engine is turned on.

In the event of a manual deployment, nozzles will deploy to near ground level and the underbody of the vehicle will be covered with suppressant fluid. The suppressant contains no hazardous materials (but may cause minor skin or eye irritation) and can be readily cleaned up by flushing the underbody with water (or soap and water). Manual deployment should have no adverse affect on vehicle handling; however, caution should be exercised in moving the vehicle as ground clearance will be compromised by the deployed nozzles. Because of reduced ground clearance, the vehicle should not be driven through an automatic car wash with nozzles in the deployed condition.

The fire suppression system is a single use system - all major components will have to be replaced in the event of a manual deployment.

## Crown Victoria Severe Duty



Figure A

The approved ISO symbol for fire suppression is shown in Figure A. This symbol is printed on the manual activation switch and on the diagnostic telltale on the instrument cluster.

The system automatically performs a diagnostic check self check and momentarily lights the cluster lamp when the key is turned on. If the diagnostic lamp stays on refer to the appropriate sections of the Ford service manual for further diagnostic and service procedures.

The system is active any time the key or engine is turned on following the diagnostic check.

The system has been designed and tested to withstand a 75 mph (120 km/h) 50% off-set rear impact by Taurus-sized vehicle. However, in some crashes, including very high-energy crashes, the fire suppression system could be so damaged by the crash forces that it cannot deploy. Like any vehicle component, the fire suppression system cannot withstand any and all crashes. No vehicle can eliminate the risk of fires. You should not consider the vehicle “fireproof” because it is equipped with a fire suppression system.

### **Ballistic door panels (if equipped)**

Your vehicle may be equipped with ballistic door panels on one or both of the front doors. Doors equipped with a ballistic panel are marked with a sticker on the interior door trim panel above the door handle indicating “BALLISTIC PANEL”. Otherwise, doors with ballistic panels are visually indistinguishable from standard doors. The ballistic panels are designed to act as a shield for the officer at the scene of an altercation.

The door panels meet National Institute of Justice (NIJ) Level III protection requirements. NIJ is the research, development, and evaluation agency within the U. S. Department of Justice. The panels have been tested and certified by a NIJ approved ballistic testing laboratory, in accordance with the methodology included in NIJ Standard 0108.01 and Los Angeles Police Department (LAPD) Standard MTD 05-01E.

288

<https://www.MyCarManual.com>



## Crown Victoria Severe Duty

Manufactured by combining ballistic grade ceramic and High Performance Para-Aramid, this composite ballistic door panel has been extensively tested with rounds called out in the above-referenced specifications.



**WARNING:** As with body armor, protection provided by the ballistic panel is limited. Certain rounds or combinations of rounds may penetrate the panel and cause serious injury or death.

### ***Use of ballistic door panels***

It is critical that officers understand where the panel is located inside the door in order to achieve optimal ballistic protection.

The door panels are designed to provide a shield for the officer at the scene of an altercation. Any protection afforded the officer while patrolling inside the vehicle is incidental.

The ballistic ceramic faces the outside of the door. **It is imperative that the officer using the panel as a ballistic shield has the exterior of the door facing the threat. In other words, the officer should be positioned behind the interior portion of the door for ballistic protection.**

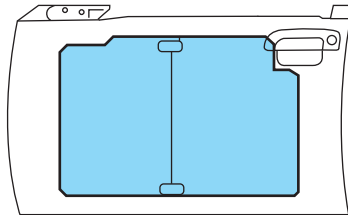

The above illustration is an outside view of the left front door. The shaded area represents the area covered by the ballistic door panel.

## Crown Victoria Severe Duty

### **Removing the panels**

It is important that these panels be removed from the vehicle after the vehicle has been impacted on the protected door, the door has been shot, or the vehicle is being removed from active duty. For details on panel removal, refer to the Crown Victoria *Workshop Manual*. After removal, please contact the following for disposition and recycling instructions:

Crown North America, Division of Leggett and Platt  
43 Gaylord Road Unit #2  
St. Thomas, ON, Canada N5P 3R9  
866-402-6838

When the panels are removed, the “Ballistic Panel” label affixed to the door trim panel must also be removed.

### **AIRBAGS**

Dual driver/passenger airbags and side airbags (if equipped) affect the way police equipment can be mounted in police vehicles.

Any surfaces that could come into contact with an airbag, once it has deployed, must not damage the airbag or alter its deployment path.

Once the airbag has fully deployed, any peripheral equipment surfaces that could come into contact with the airbag (such as when the airbag deflates with the loading of an occupant) must not damage the airbag or alter its deployment path. Sharp edges, corners or protrusions could damage the nylon airbag material and reduce the effectiveness of the airbag.



**WARNING:** Do not place objects or mount equipment in front of the airbag module cover or in front of the seat areas that may come in contact with a deploying airbag. Failure to follow this instruction could result in personal injury.



**WARNING:** Dash, tunnel or console-mounted equipment should not be placed outside of the specified zone. Failure to follow this instruction could result in personal injury.



**WARNING:** Do not mount equipment between the side of front seat to the door trim to block deployment of the side airbag. Failure to follow this instruction could result in personal injury.

## Crown Victoria Severe Duty

Some approximate dimensions for airbags, at full inflation, are provided in Figures 1 through 5. These dimensions are somewhat flexible and represent “free form” deployments without the loading of occupants. The shaded areas in Figures 6 through 8 represent available police equipment mounting zones. These zones are shown for police vehicles equipped with standard bucket seats. While bench seats are optional and still appropriate for vehicles with certain limited police equipment requirements, the standard bucket seats are recommended for vehicles that require maximum available space for police equipment mounting. The zone dimensions provided in Figures 6 through 8 are approximate and will vary with the loading of occupants in the seats.

All airbag and equipment mounting zone dimensions are approximate due to different airbag deployment characteristics.

No equipment will mount between the side of the front seat and the door trim to block deployment of the side airbag.

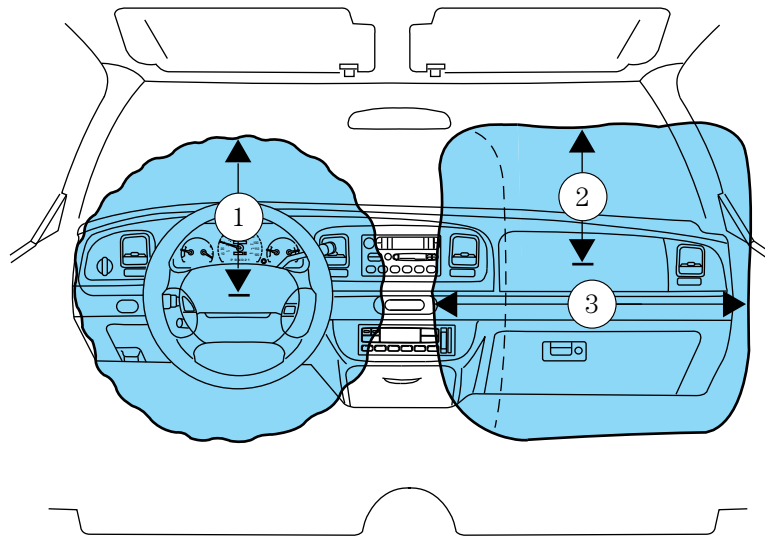

Figure 1

1. 9.5 inches (240 mm) from center of airbag door
2. 15.7 inches (400 mm) from center of airbag door
3. 28.5 inches (725 mm)

No objects should be placed between the airbags due to airbag variability.

## Crown Victoria Severe Duty

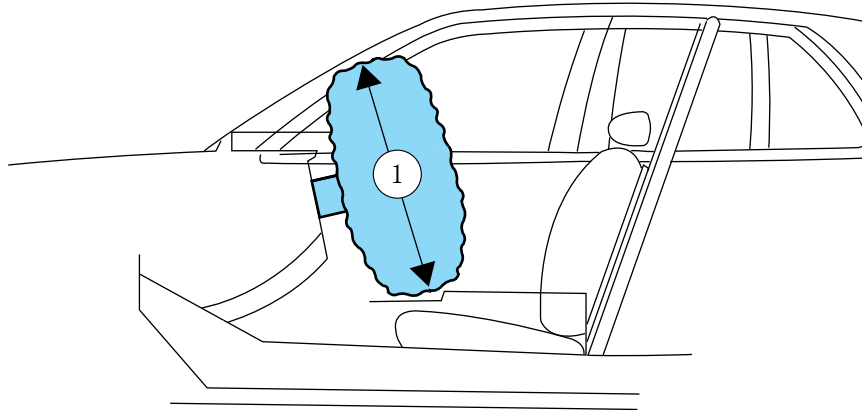

Figure 2

1. 30.5 inches (775 mm). Cross section through center of vehicle (passenger side shown)

## Crown Victoria Severe Duty

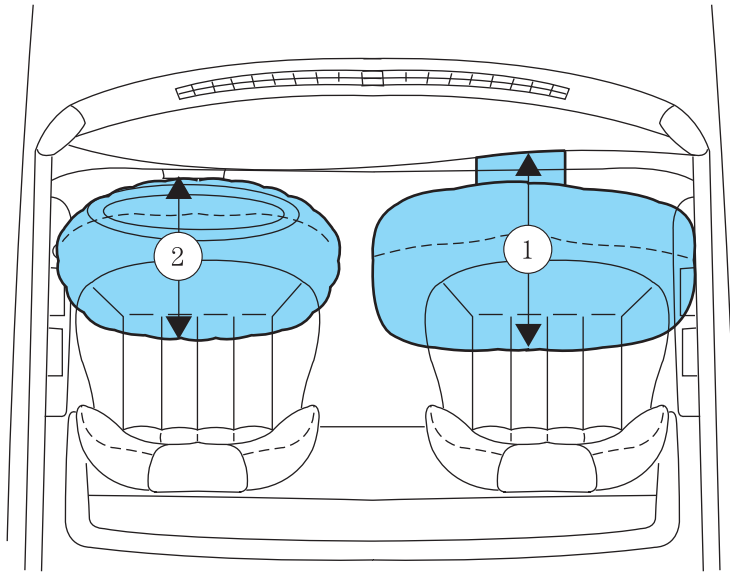

Figure 3

1. 23.6 inches (600 mm). Front passenger compartment
2. 17 inches (430 mm). Front driver

## Crown Victoria Severe Duty

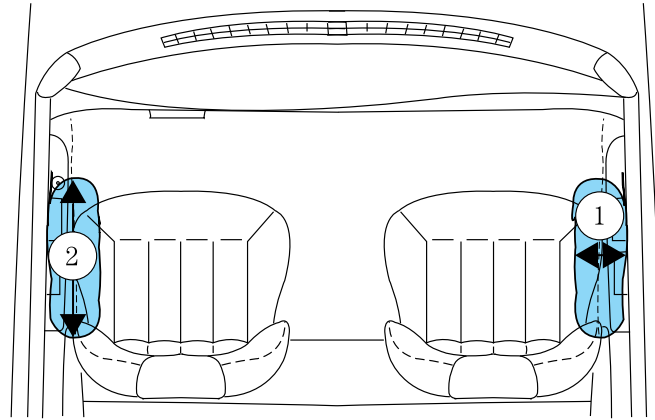

Figure 4 (if equipped)

1. 8 inches (200 mm). From out board side of seat
2. 15 inches (380 mm). Forward of seat back

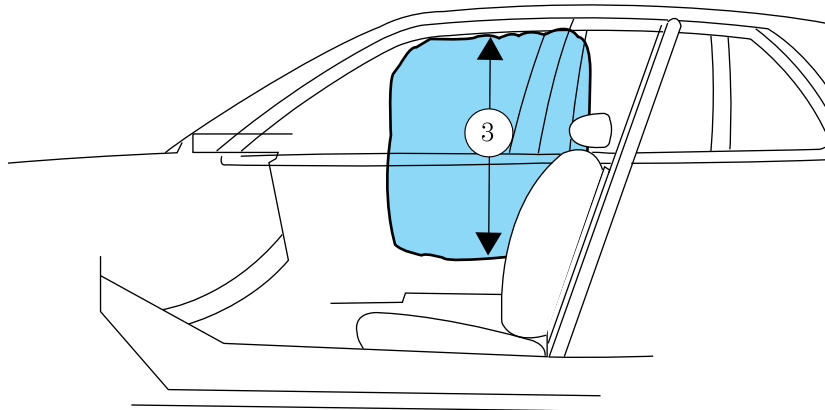

Figure 5 (if equipped)

3. 27.5 inches (700 mm). Up from SAB module

## Crown Victoria Severe Duty

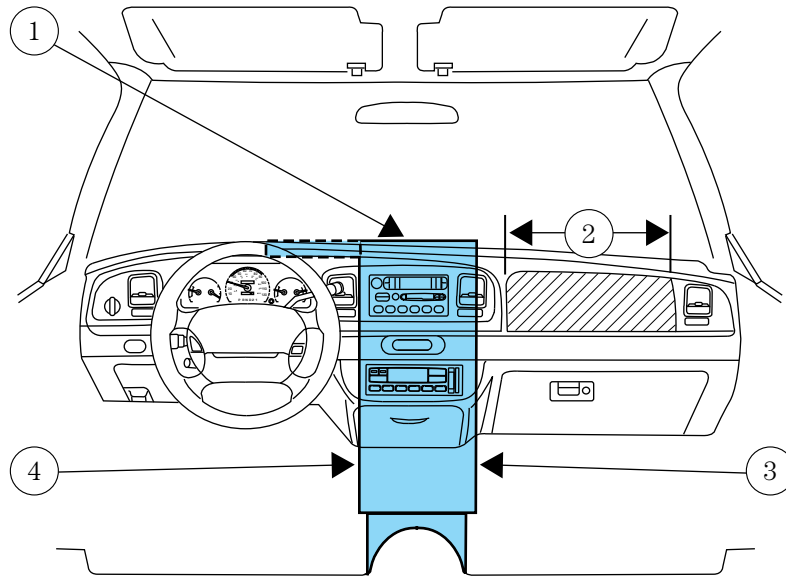

Figure 6

1. Area on top of instrument panel. **Equipment must not interfere with driver visibility.**
2. The airbag door must be kept clear for deployment of airbag
3. Area in front of center console from bottom of ashtray to top of instrument panel (see Figure 2 for dimensions)
4. 11 inches (279 mm) width horizontally centered on ashtray door.

## Crown Victoria Severe Duty

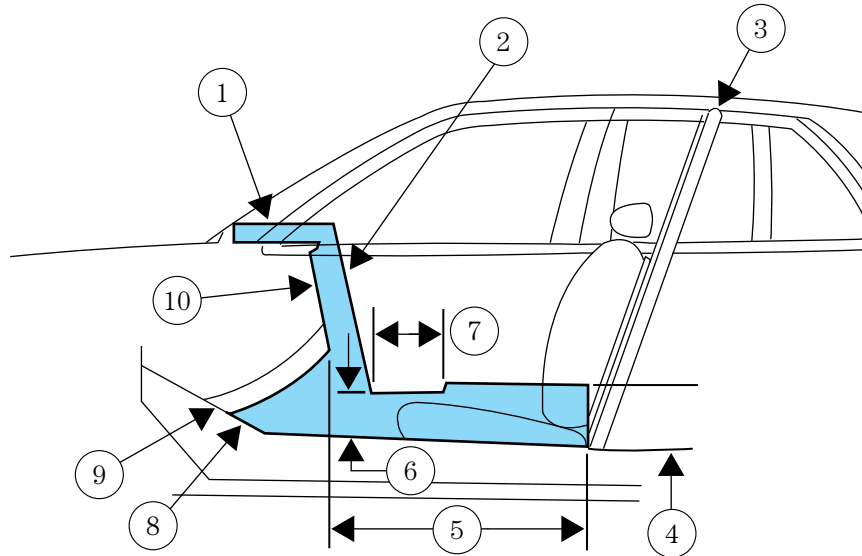

Figure 7

1. Area on top of instrument panel
2. Area in front of center console from tunnel up to instrument panel
3. Prisoner screen
4. 10 inches (254 mm)
5. Area on tunnel between seats
6. Height: 8.5 inches (216 mm)
7. 12 inches (305 mm)
8. Area on tunnel beneath center console
9. Tunnel
10. Depth: 1.5 inches (38 mm)



## Crown Victoria Severe Duty

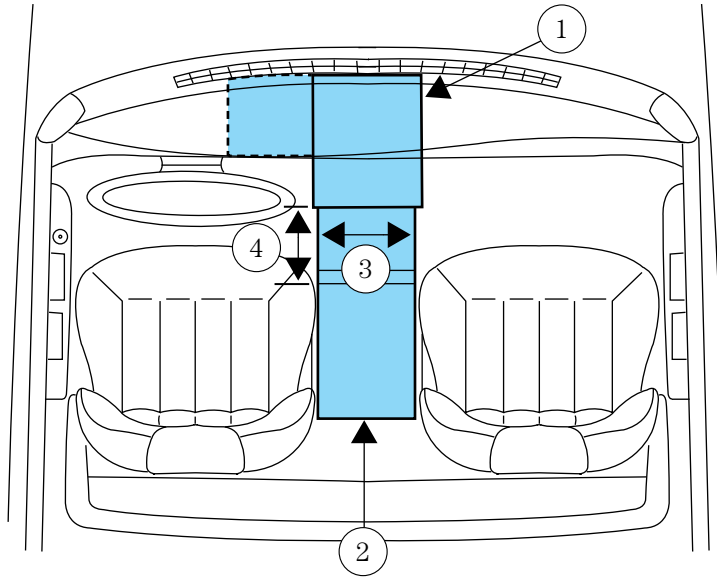

Figure 8

1. Area on top of instrument panel. **Equipment must not interfere with driver visibility.**
2. Area on tunnel between seats
3. 9 inches (229 mm)
4. 12 inches (305 mm)

### IMPORTANT AIRBAG DOS AND DON'TS



**WARNING:** Do not attempt to tamper with, disconnect or deactivate the airbag system.

Tampering with an airbag system could cause the bag to inflate or become inoperative. The airbag system should not be disconnected or deactivated.



**WARNING:** Do not mount or place any objects in the deployment path of an airbag.

## Crown Victoria Severe Duty

Airbags must be allowed to fully deploy without restriction. The deployment of airbags is not compatible with any configuration of police equipment mounting that places objects in the airbag deployment path. Equipment mounted or placed in the deployment path area of an airbag will reduce the effectiveness of the airbag, damage the airbag and potentially damage or dislodge the equipment. Further such items could become projectiles in the event of an airbag deployment.



**WARNING:** Always use safety belts with the airbag supplemental restraint system.

There are four very important reasons to always use seat belts with the airbag system. Safety belts:

- help restrain the occupant to increase the effectiveness of the airbag when it inflates.
- reduce the risk of injury in rollover, side or rear impact accidents for which airbags are not designed to inflate.
- reduce the risk of injury in frontal collisions that are not severe enough to activate the airbag.
- reduce the risk of passengers being thrown from the vehicle.

### **SOME COMMON POLICE QUESTIONS AND ANSWERS ABOUT AIRBAGS**

#### ***Will there be any way to special order police vehicles without the airbag systems?***

No. Based on the federal law (FMVSS #208), after August 31, 1993, the Original Equipment Manufacturers (OEMs) will not be able to sell passenger cars that do not contain passive restraint systems.

#### ***Can the installation of push bumpers on the front end of the vehicle affect the deployment of an airbag?***

Different push bumper designs may each have different deformation characteristics in a crash situation that may or may not affect the deployment of airbags. Without the benefit of crash tests on vehicles equipped with push bumpers (there are a number of different styles available), it is Ford's opinion that installation of some push bumpers could affect the timing of the airbag deployment. Use of a push bumper that mounts solely to the vehicles bumper should not have a significant effect upon airbag deployment.

## Crown Victoria Severe Duty

***Is there a problem with transporting a front seat passenger who has their hands restrained behind their body?***

This is not a normal riding position for an occupant. The effectiveness of the passenger airbag will depend, in part, upon the occupant's seated position. It is recommended that the seat should be adjusted as far rearward as possible for this situation, and that the occupant sit as upright as possible and be properly safety belted. It is recommended that such passengers be properly restrained in the rear seat if at all possible.

***Can conditions encountered in aggressive pursuit driving situations (e.g., high speed braking, uneven road surfaces) cause inadvertent inflation of an airbag that might result in loss of vehicle control?***

No. Aggressive pursuit driving conditions do not fit this criteria. Airbags are designed to deploy in moderate to major frontal crashes based on the detection of sudden deceleration by sensors in the vehicle.

## Accessories

### FORD CUSTOM ACCESSORIES FOR YOUR VEHICLE

A wide selection of Ford Custom Accessories are available for your vehicle through your local Ford or Ford of Canada dealer. These quality accessories have been specifically engineered to fulfill your automotive needs; they are custom designed to complement the style and aerodynamic appearance of your vehicle. In addition, each accessory is made from high quality materials and meets or exceeds Ford's rigorous engineering and safety specifications. Ford Motor Company will repair or replace any properly dealer-installed Ford Custom Accessories found to be defective in factory-supplied materials or workmanship during the warranty period, as well as any component damaged by the defective accessories. The accessories will be warranted for whichever provides you the greatest benefit:

- 12 months or 12,000 miles (20,000 km) (whichever occurs first), or
- the remainder of your new vehicle limited warranty.

Contact your dealer for details and a copy of the warranty.

The following is a list of several Ford Custom Accessories. Not all accessories are available for all models. For a complete listing of the accessories that are available for your vehicle, please contact your dealer or visit our online store at: [www.fordaccessories.com](http://www.fordaccessories.com) (U.S. only).

#### Lifestyle

- Garmin navigation\*

#### Peace of mind

- Vehicle tracking and recovery\*      •Back up camera\*
- Back up alarm\*
- Bumper mounted parking sensors\*
- Hitch mounted parking sensor\*

\*Ford Licensed Accessories (FLA) are warranted by the accessory manufacturer's warranty. Ford Licensed Accessories are fully designed and developed by the accessory manufacturer and have not been designed or tested to Ford Motor Company engineering requirements. Contact your Ford dealer for details regarding the manufacturer's limited warranty and/or a copy of the FLA product limited warranty offered by the accessory manufacturer.

## Accessories

For maximum vehicle performance, keep the following information in mind when adding accessories or equipment to your vehicle:

- When adding accessories, equipment, passengers and luggage to your vehicle, do not exceed the total weight capacity of the vehicle or of the front or rear axle (GVWR or GAWR as indicated on the Safety Compliance Certification label). Consult your authorized dealer for specific weight information.
- The Federal Communications Commission (FCC) and Canadian Radio Telecommunications Commission (CRTC) regulate the use of mobile communications systems — such as two-way radios, telephones and theft alarms - that are equipped with radio transmitters. Any such equipment installed in your vehicle should comply with FCC or CRTC regulations and should be installed only by a qualified service technician.
- Mobile communications systems may harm the operation of your vehicle, particularly if they are not properly designed for automotive use.
- To avoid interference with other vehicle functions, such as anti-lock braking systems, amateur radio users who install radios and antennas onto their vehicle should not locate the Amateur Radio Antennas in the area of the driver's side hood.
- Electrical or electronic accessories or components that are added to the vehicle by the authorized dealer or the owner, may adversely affect battery performance and durability, and may also adversely affect the performance of other electrical systems in the vehicle.

## Ford Extended Service Plan

### FORD ESP EXTENDED SERVICE PLANS (U.S. ONLY)

More than 30 million Ford and Lincoln owners have discovered the powerful protection of Ford ESP. It is the only extended service plan backed by Ford Motor Company, and provides “peace of mind” protection beyond the New Vehicle Limited Warranty coverage.

#### ***Up to 500+ Covered Vehicle Components***

There are four, new-vehicle Extended Service Plans with different levels of coverage. Ask your dealer for details.

**PremiumCare** – Our most comprehensive coverage. With over 500 covered components, this plan is so complete that we generally only discuss what’s not covered!

**ExtraCare** – Covers 113 components, and includes many high-tech items.

**BaseCare** – Covers 84 components.

**PowertrainCare** – Covers 29 critical components.

**Ford ESP is honored by all Ford and Lincoln Dealers in the U.S. and Canada** It’s the only extended service plan authorized and backed by Ford Motor Company. That means you get:

- Reliable, quality service anywhere you go.
- **Factory-trained technicians.**
- **Genuine Ford and Motorcraft® Parts.**

#### ***Rental car reimbursement***

**If your vehicle is kept overnight for covered repairs**, you are eligible for rental car coverage, including Bumper-to-Bumper warranty repairs, or manufacturer’s recalls.

#### ***Transferable coverage***

If you sell your vehicle before your Ford ESP coverage expires, you can transfer any remaining coverage to the new owner. Whenever you’re ready to sell your car, prospective buyers may feel better about taking a risk on your used vehicle. Ford ESP may add resale value!

Plus, **exclusive 24/7 roadside assistance**, including:

- Towing, flat-tire change and battery jump starts.
- Out-of-fuel and lock-out assistance.
- Travel expense reimbursement for lodging, meals and rental car.
- Destination assistance for taxi, shuttle, rental car coverage and emergency transportation.

## Ford Extended Service Plan

### ***Ford ESP Can Quickly Pay for Itself***

One service bill – the cost of parts and labor – can easily exceed the price of your Ford ESP Service Contract. With Ford ESP, you minimize your risk for unexpected repair bills and rising repair costs.

### ***Avoid the rising cost of properly maintaining your vehicle!***

Ford ESP also offers a Premium Maintenance Plan that covers items that **routinely wear out**.

The coverage is prepaid, so you never have to worry about affording your vehicle maintenance. It covers regular checkups, routine inspections, preventive care and replacement of items that require periodic attention for **normal “wear”**:

- **Wiper blades**
- **Spark plugs (except California)**
- **Clutch disc**
- **Brake pads and linings**
- **Shock absorbers**
- **Belts and hoses**

Contact your selling Ford or Lincoln dealership today so they can customize a Ford Extended Service Plan that fits your driving lifestyle and budget.

### ***Interest free finance options available***

Take advantage of our installment payment plan, just a 10% down payment will provide you with an affordable no interest, no-fee payment opportunity.

Ford Extended Service Plan



***Get Genuine Peace of Mind with Ford ESP!***

To learn more, complete the information below and mail this to:

**Ford ESP  
P.O. Box 8072  
Royal Oak, MI 48068-9933**

NAME (PLEASE PRINT) \_\_\_\_\_

ADDRESS \_\_\_\_\_ APT.NO. \_\_\_\_\_

CITY \_\_\_\_\_ STATE \_\_\_\_\_ ZIP \_\_\_\_\_

E-MAIL: \_\_\_\_\_



## Ford Extended Service Plan

### **FORD ESP EXTENDED SERVICE PLANS (CANADA ONLY)**

You can get more protection for your vehicle by purchasing a Ford Extended Service Plan (ESP). Ford ESP is the only service contract backed by Ford Motor Company of Canada, Limited. Depending on the plan you purchase, Ford ESP provides benefits such as:

- Rental reimbursement
- Coverage for certain maintenance and wear items
- Protection against repair costs after your New Vehicle Limited Warranty Coverage expires
- Roadside Assistance benefits

There are several Ford ESP plans available in various time, distance and deductible combinations. Each plan is tailored to fit your own driving needs, including reimbursement for towing and rental.

When you purchase Ford ESP, you receive added peace-of-mind protection throughout Canada and the United States, provided by a network of participating Ford Motor Company dealers.

For more information, visit your local Ford of Canada dealer or [www.ford.ca](http://www.ford.ca) to find the Ford Extended Service Plan that is right for you.

**Note:** Repairs performed outside of Canada and the United States are not eligible for Ford ESP coverage. This information is subject to change.

## Scheduled Maintenance

### GENERAL MAINTENANCE INFORMATION

#### Why maintain your vehicle?

This guide describes the scheduled maintenance required for your vehicle. Carefully following this schedule helps protect against major repair expenses resulting from neglect or inadequate maintenance and may also help to increase the value of your vehicle when you sell or trade it.

It is your responsibility to see that all scheduled maintenance is performed and that the materials used meet Ford engineering specifications as identified in the *Maintenance and Specifications* chapter. Failure to perform scheduled maintenance specific in this guide will invalidate warranty coverage on parts affected by the lack of maintenance. Be sure receipts for completed maintenance are kept with the vehicle and confirmation of the work performed is always recorded in this guide.

Your dealer has factory-trained technicians who can perform the required maintenance using genuine Ford parts. They are committed to meeting your service needs and to assuring your continuing satisfaction.

#### Protecting your investment

Maintenance is an investment that will pay dividends in the form of improved reliability, durability and resale value. To ensure the proper performance of your vehicle and its emission control systems, it is imperative that scheduled maintenance be completed at the designated intervals.

Your vehicle is very sophisticated and built with multiple complex performance systems. Every manufacturer develops these systems using different specifications and performance features. That's why it's important to rely upon your dealership to properly diagnose and repair your vehicle.

Ford Motor Company has recommended maintenance intervals for various parts and component systems based upon engineering testing. Ford Motor Company relies upon this testing to determine the most appropriate mileage for replacement of oils and fluids to protect your vehicle at the lowest overall cost to you and recommends against maintenance schedules that deviate from the scheduled maintenance information.

## Scheduled Maintenance

Ford strongly recommends the use of genuine Ford replacement parts. Parts other than Ford, Motorcraft® or Ford-authorized remanufactured parts that are used for maintenance replacement or for the service of components affecting emission control must be equivalent to genuine Ford Motor Company parts in performance and durability. It is the owner's responsibility to determine the equivalency of such parts. Please consult your *Warranty Guide* for complete warranty information.

Chemicals or additives not approved by Ford are not required for factory recommended maintenance. In fact, Ford Motor Company recommends against the use of such additive products unless specifically recommended by Ford for a particular application.

### **Oils, fluids and flushing**

In many cases, fluid discoloration is a normal operating characteristic and, by itself, does not necessarily indicate a concern or that the fluid needs to be changed. However, discolored fluids that also show signs of overheating and/or foreign material contamination should be inspected immediately by a qualified expert such as the factory-trained technicians at your dealership. Your vehicle's oils and fluids should be changed at the specified intervals or in conjunction with a repair. Flushing is a viable way to change fluid for many vehicle sub-systems during scheduled maintenance. It is critical that systems are flushed only with new fluid that is the same as that required to fill and operate the system, or using a Ford-approved flushing chemical.

### **Genuine Ford parts and service**

When planning your maintenance services, consider your dealership for all your vehicle's needs.

There are a lot of reasons why visiting your dealership for all your service needs is a great way to help keep your vehicle running great.

### **Convenience**

Many dealerships have extended evening and Saturday hours to make your service visit more convenient. How's that for quality service?

### **Factory-trained technicians**

Service technicians participate in extensive factory-sponsored certification training to help them become experts on the operation of your vehicle. Ask your dealership about the training and certification their technicians have received.

## Scheduled Maintenance

### ***Genuine Ford and Motorcraft® replacement parts***

Dealerships stock Ford and Motorcraft® branded replacement parts. These parts meet or exceed Ford Motor Company's specifications, and we stand behind them. Parts installed at your dealership carry a nationwide, 12 month/12,000 mile (20,000 km) parts and labor limited warranty. Your dealer can give you details.

### ***Value shopping for your vehicle's maintenance needs***

Your dealership recognizes the competitive landscape of maintenance and light repair automotive services. With factory-trained technicians, and one-stop service from routine maintenance like oil changes and tire rotations to repairs like brake service, check out the value your dealers can offer.

### **Owner checks and services**

Certain basic maintenance checks and inspections should be performed by the owner or a service technician at the intervals indicated. Service information and supporting specifications are provided in this owner's guide.

Any adverse condition should be brought to the attention of your dealer or qualified service technician as soon as possible for the proper service advice. The owner maintenance service checks are generally not covered by warranties so you may be charged for labor, parts or fluids used.

<b>Engine oil/coolant change intervals</b>	
<b>Engine oil</b>	6 months or 7,500 miles (12,000 km) (whichever comes first)
<b>Engine coolant, initial change</b>	6 years or 105,000 miles (168,000 km) (whichever comes first)
<b>Engine coolant, after initial change</b>	Every 3 years or 45,000 miles (72,000 km)

<b>Check every month</b>
Engine oil level
Function of all interior and exterior lights
Tires for wear and proper pressure, including spare
Windshield washer fluid level

## Scheduled Maintenance

<b>Check every six months</b>
Battery connections; clean if necessary
Body and door drain holes for obstructions; clean if necessary
Cooling system fluid level and coolant strength
Door weatherstrips for wear; lubricate if necessary
Hinges/latches/outside locks for proper operation; lubricate if necessary
Parking brake for proper operation
Safety belts and seat latches for wear and function
Safety warning lamps (brake, ABS, airbag, safety belt) for operation
Washer spray/wiper operation; clean or replace blades as necessary

### Multi-point inspection

In order to keep your vehicle running right, it is important to have the systems on your vehicle checked regularly. This can help identify potential issues and prevent major problems. Ford Motor Company recommends the following multi-point inspection be performed at every scheduled maintenance interval to help ensure your vehicle keeps running great.

<b>Multi-point inspection – Recommended each visit</b>	
Accessory drive belt(s)	Half-shaft dust boots (if equipped)
Battery performance	Horn operation
Clutch operation (if equipped)	Radiator, cooler, heater and A/C hoses
Engine air filter	Suspension component for leaks or damage
Exhaust system	Steering and linkage
Exterior lamps and hazard warning system operation	Tires for wear and proper pressure, including spare
Fluid levels*; fill if necessary	Windshield for cracks, chips or pits
For oil and fluid leaks	Washer spray and wiper operation
*Brake, coolant recovery reservoir, manual and automatic transmission (with an underhood dipstick), power steering (if equipped) and window washer	

Be sure to ask your dealership service advisor or technician about the multi-point vehicle inspection. It's a comprehensive way to perform a thorough inspection of your vehicle. It's your checklist that gives you immediate feedback on the overall condition of your vehicle. You'll know what's been checked, what's okay, as well as those things that may require future or immediate attention. The multi-point vehicle inspection is one more way to keep your vehicle running great!

# Scheduled Maintenance

Owner's Member #: \_\_\_\_\_  
 Owner's Service Balance: \_\_\_\_\_

**Multi-Point Inspection Report Card as Recommended by Ford Motor Company**

Make: \_\_\_\_\_ Model/Year: \_\_\_\_\_ Mileage: \_\_\_\_\_

Days: \_\_\_\_\_ Time: \_\_\_\_\_ Static Inspection: \_\_\_\_\_

Vehicle Address: \_\_\_\_\_

SCHEDULED MAINTENANCE ITEMS DUE FOR SERVICES ON THIS VEHICLE			
ITEM	STATUS	ITEM	STATUS
Oil Change	<input type="checkbox"/>	Oil Filter	<input type="checkbox"/>
Cabin Air Filter	<input type="checkbox"/>	Spark Plugs	<input type="checkbox"/>
Engine Air Filter	<input type="checkbox"/>	Tire Rotation	<input type="checkbox"/>
Engine Coolant	<input type="checkbox"/>	Transmission Fluid	<input type="checkbox"/>
Blind Spot Monitor	<input type="checkbox"/>	Transmission Filter	<input type="checkbox"/>
Oil Change	<input type="checkbox"/>	Transmission Fluid	<input type="checkbox"/>

\*This is only a partial list of vehicle maintenance items and is NOT all-inclusive. Please consult your Owner's Manual or visit [www.genuineparts.com](http://www.genuineparts.com) for vehicle specific maintenance requirements.

CHECK FLUID LEVELS AND FILL			
ITEM	STATUS	ITEM	STATUS
Oil and/or Oil Leaks	<input type="checkbox"/>	Power Steering	<input type="checkbox"/>
Wash Fluid	<input type="checkbox"/>	Windshield Washer	<input type="checkbox"/>
Brake Fluid	<input type="checkbox"/>	Windshield Washer	<input type="checkbox"/>
Brake Pads	<input type="checkbox"/>	Windshield Washer	<input type="checkbox"/>

BATTERY	
State of Health	Condition of Cell
<div style="width: 50%; height: 10px; background: linear-gradient(to right, green 50%, red 50%);"></div>	<input type="checkbox"/>

EXTERIOR BODY	
Factory spec cold cranking amps	Antenna Lock
<input type="checkbox"/>	<input type="checkbox"/>

TIRE/BRAKE WEAR																	
Left Front	Right Front																
<table border="1" style="width: 100%; border-collapse: collapse;"> <tr> <td>Tire Tread</td> <td>Wear Pattern</td> <td>Pressure</td> <td>Brake Linings</td> </tr> <tr> <td><input type="checkbox"/></td> <td><input type="checkbox"/></td> <td><input type="checkbox"/></td> <td><input type="checkbox"/></td> </tr> </table>	Tire Tread	Wear Pattern	Pressure	Brake Linings	<input type="checkbox"/>	<input type="checkbox"/>	<input type="checkbox"/>	<input type="checkbox"/>	<table border="1" style="width: 100%; border-collapse: collapse;"> <tr> <td>Tire Tread</td> <td>Wear Pattern</td> <td>Pressure</td> <td>Brake Linings</td> </tr> <tr> <td><input type="checkbox"/></td> <td><input type="checkbox"/></td> <td><input type="checkbox"/></td> <td><input type="checkbox"/></td> </tr> </table>	Tire Tread	Wear Pattern	Pressure	Brake Linings	<input type="checkbox"/>	<input type="checkbox"/>	<input type="checkbox"/>	<input type="checkbox"/>
Tire Tread	Wear Pattern	Pressure	Brake Linings														
<input type="checkbox"/>	<input type="checkbox"/>	<input type="checkbox"/>	<input type="checkbox"/>														
Tire Tread	Wear Pattern	Pressure	Brake Linings														
<input type="checkbox"/>	<input type="checkbox"/>	<input type="checkbox"/>	<input type="checkbox"/>														
Left Rear	Right Rear																
<table border="1" style="width: 100%; border-collapse: collapse;"> <tr> <td>Tire Tread</td> <td>Wear Pattern</td> <td>Pressure</td> <td>Brake Linings</td> </tr> <tr> <td><input type="checkbox"/></td> <td><input type="checkbox"/></td> <td><input type="checkbox"/></td> <td><input type="checkbox"/></td> </tr> </table>	Tire Tread	Wear Pattern	Pressure	Brake Linings	<input type="checkbox"/>	<input type="checkbox"/>	<input type="checkbox"/>	<input type="checkbox"/>	<table border="1" style="width: 100%; border-collapse: collapse;"> <tr> <td>Tire Tread</td> <td>Wear Pattern</td> <td>Pressure</td> <td>Brake Linings</td> </tr> <tr> <td><input type="checkbox"/></td> <td><input type="checkbox"/></td> <td><input type="checkbox"/></td> <td><input type="checkbox"/></td> </tr> </table>	Tire Tread	Wear Pattern	Pressure	Brake Linings	<input type="checkbox"/>	<input type="checkbox"/>	<input type="checkbox"/>	<input type="checkbox"/>
Tire Tread	Wear Pattern	Pressure	Brake Linings														
<input type="checkbox"/>	<input type="checkbox"/>	<input type="checkbox"/>	<input type="checkbox"/>														
Tire Tread	Wear Pattern	Pressure	Brake Linings														
<input type="checkbox"/>	<input type="checkbox"/>	<input type="checkbox"/>	<input type="checkbox"/>														

Comments: \_\_\_\_\_

Service Advisor: \_\_\_\_\_ Customer Signature: \_\_\_\_\_

Technician: \_\_\_\_\_ Customer Copy

12-XXXXXXX

## Scheduled Maintenance

### **NORMAL SCHEDULED MAINTENANCE AND LOG**

The following section contains the “Normal Schedule”. This schedule is presented at specific mileage (kilometer) intervals with exceptions noted.

## Scheduled Maintenance

Miles (x 1,000)*	7.5	15	22.5	30	37.5	45	52.5	60	67.5	75
Kilometers (x 1,000)*	12	24	36	48	60	72	84	96	108	120
Months*	6	12	18	24	30	36	42	48	54	60
Change engine oil and filter	•	•	•	•	•	•	•	•	•	•
Rotate tires, inspect tire wear and measure tread depth	•	•	•	•	•	•	•	•	•	•
Inspect wheels and related components for abnormal noise, wear, looseness or drag	•	•	•	•	•	•	•	•	•	•
Perform multi-point inspection (recommended)	•	•	•	•	•	•	•	•	•	•
Inspect automatic transmission fluid level (if equipped with dipstick); consult dealer for requirements		•		•		•		•		•
Inspect brake pads, shoes, rotors, drums, brake linings, hoses and parking brake		•		•		•		•		•
Inspect engine cooling system concentration and hoses		•		•		•		•		•
Inspect exhaust system and heat shields		•		•		•		•		•
Inspect half-shaft boots (if equipped)		•		•		•		•		•
Inspect steering linkage, ball joints, suspension, tie-rod ends, driveshaft and U-joints; lubricate if equipped with grease fittings		•		•		•		•		•
Inspect cabin air filter (if equipped)	•		•		•		•		•	

\* Whichever comes first



## Scheduled Maintenance

	82.5	90	97.5	105	112.5	120	127.5	135	142.5	150
<b>Miles (x 1,000)*</b>	132	144	156	168	180	192	204	216	228	240
<b>Kilometers (x 1,000)*</b>	66	72	78	84	90	96	102	108	114	120
<b>Months*</b>										
Change engine oil and filter	•	•	•	•	•	•	•	•	•	•
Rotate tires, inspect tire wear and measure tread depth	•	•	•	•	•	•	•	•	•	•
Inspect wheels and related components for abnormal noise, wear, looseness or drag	•	•	•	•	•	•	•	•	•	•
Perform multi-point inspection (recommended)	•	•	•	•	•	•	•	•	•	•
Inspect automatic transmission fluid level (if equipped with dipstick); consult dealer for requirements		•		•		•		•		•
Inspect brake pads, shoes, rotors, drums, brake linings, hoses and parking brake		•		•		•		•		•
Inspect engine cooling system concentration and hoses		•		•		•		•		•
Inspect exhaust system and heat shields		•		•		•		•		•
Inspect half-shaft boots (if equipped)		•		•		•		•		•
Inspect steering linkage, ball joints, suspension, tie-rod ends, driveshaft and U-joints; lubricate if equipped with grease fittings		•		•		•		•		•
Inspect cabin air filter (if equipped)	•		•		•		•		•	

\* Whichever comes first

## Scheduled Maintenance

Every 15,000 miles (24,000 km)	Replace cabin air filter (if equipped)
Every 30,000 miles (48,000 km)	Replace climate-controlled seat filter (if equipped)
	Replace engine air filter
	Replace fuel filter (Crown Victoria, Grand Marquis and Town Car)
Every 105,000 miles (168,000 km)	Change engine coolant <sup>1</sup>
	Replace spark plugs
	Inspect accessory drive belt(s) <sup>2</sup>
Every 150,000 miles (240,000 km)	Change automatic transmission fluid and filter (filter not required on 6F35, 6F50, DPS6 and AWF-21 transmissions); consult dealer for requirements
	Change manual transmission fluid
	Change rear axle fluid (RWD vehicles)
	Replace accessory drive belt(s) if not replaced within the last 100,000 miles (160,000 km)
	Replace timing belt (Fiesta); <b>failure to replace belt can cause internal engine damage</b>
<sup>1</sup> Initial replacement at 105,000 miles (168,000 km) or 72 months; every 45,000 miles (72,000 km) or 36 months thereafter	
<sup>2</sup> Perform a follow-up inspection at 120,000 miles (192,000 km)	

## Scheduled Maintenance

### Maintenance schedule log

<p style="text-align: center;">DEALER VALIDATION:</p> <p style="text-align: center;">P&amp;A CODE:</p> <p>RO#:                    HOURS:</p> <p>DATE:                  MILEAGE:</p>	<p style="text-align: center;">DEALER VALIDATION:</p> <p style="text-align: center;">P&amp;A CODE:</p> <p>RO#:                    HOURS:</p> <p>DATE:                  MILEAGE:</p>
<p style="text-align: center;">DEALER VALIDATION:</p> <p style="text-align: center;">P&amp;A CODE:</p> <p>RO#:                    HOURS:</p> <p>DATE:                  MILEAGE:</p>	<p style="text-align: center;">DEALER VALIDATION:</p> <p style="text-align: center;">P&amp;A CODE:</p> <p>RO#:                    HOURS:</p> <p>DATE:                  MILEAGE:</p>
<p style="text-align: center;">DEALER VALIDATION:</p> <p style="text-align: center;">P&amp;A CODE:</p> <p>RO#:                    HOURS:</p> <p>DATE:                  MILEAGE:</p>	<p style="text-align: center;">DEALER VALIDATION:</p> <p style="text-align: center;">P&amp;A CODE:</p> <p>RO#:                    HOURS:</p> <p>DATE:                  MILEAGE:</p>
<p style="text-align: center;">DEALER VALIDATION:</p> <p style="text-align: center;">P&amp;A CODE:</p> <p>RO#:                    HOURS:</p> <p>DATE:                  MILEAGE:</p>	<p style="text-align: center;">DEALER VALIDATION:</p> <p style="text-align: center;">P&amp;A CODE:</p> <p>RO#:                    HOURS:</p> <p>DATE:                  MILEAGE:</p>
<p style="text-align: center;">DEALER VALIDATION:</p> <p style="text-align: center;">P&amp;A CODE:</p> <p>RO#:                    HOURS:</p> <p>DATE:                  MILEAGE:</p>	<p style="text-align: center;">DEALER VALIDATION:</p> <p style="text-align: center;">P&amp;A CODE:</p> <p>RO#:                    HOURS:</p> <p>DATE:                  MILEAGE:</p>

## Scheduled Maintenance

<p style="text-align: center;">DEALER VALIDATION:</p>  <p style="text-align: center;">P&amp;A CODE:</p> <p>RO#:            HOURS:</p> <p>DATE:           MILEAGE:</p>	<p style="text-align: center;">DEALER VALIDATION:</p>  <p style="text-align: center;">P&amp;A CODE:</p> <p>RO#:            HOURS:</p> <p>DATE:           MILEAGE:</p>
<p style="text-align: center;">DEALER VALIDATION:</p>  <p style="text-align: center;">P&amp;A CODE:</p> <p>RO#:            HOURS:</p> <p>DATE:           MILEAGE:</p>	<p style="text-align: center;">DEALER VALIDATION:</p>  <p style="text-align: center;">P&amp;A CODE:</p> <p>RO#:            HOURS:</p> <p>DATE:           MILEAGE:</p>
<p style="text-align: center;">DEALER VALIDATION:</p>  <p style="text-align: center;">P&amp;A CODE:</p> <p>RO#:            HOURS:</p> <p>DATE:           MILEAGE:</p>	<p style="text-align: center;">DEALER VALIDATION:</p>  <p style="text-align: center;">P&amp;A CODE:</p> <p>RO#:            HOURS:</p> <p>DATE:           MILEAGE:</p>
<p style="text-align: center;">DEALER VALIDATION:</p>  <p style="text-align: center;">P&amp;A CODE:</p> <p>RO#:            HOURS:</p> <p>DATE:           MILEAGE:</p>	<p style="text-align: center;">DEALER VALIDATION:</p>  <p style="text-align: center;">P&amp;A CODE:</p> <p>RO#:            HOURS:</p> <p>DATE:           MILEAGE:</p>
<p style="text-align: center;">DEALER VALIDATION:</p>  <p style="text-align: center;">P&amp;A CODE:</p> <p>RO#:            HOURS:</p> <p>DATE:           MILEAGE:</p>	<p style="text-align: center;">DEALER VALIDATION:</p>  <p style="text-align: center;">P&amp;A CODE:</p> <p>RO#:            HOURS:</p> <p>DATE:           MILEAGE:</p>

## Scheduled Maintenance

<p style="text-align: center;">DEALER VALIDATION:</p> <p>RO#: P&amp;A CODE:            HOURS:            DATE: MILEAGE:</p>	<p style="text-align: center;">DEALER VALIDATION:</p> <p>RO#: P&amp;A CODE:            HOURS:            DATE: MILEAGE:</p>
<p style="text-align: center;">DEALER VALIDATION:</p> <p>RO#: P&amp;A CODE:            HOURS:            DATE: MILEAGE:</p>	<p style="text-align: center;">DEALER VALIDATION:</p> <p>RO#: P&amp;A CODE:            HOURS:            DATE: MILEAGE:</p>
<p style="text-align: center;">DEALER VALIDATION:</p> <p>RO#: P&amp;A CODE:            HOURS:            DATE: MILEAGE:</p>	<p style="text-align: center;">DEALER VALIDATION:</p> <p>RO#: P&amp;A CODE:            HOURS:            DATE: MILEAGE:</p>
<p style="text-align: center;">DEALER VALIDATION:</p> <p>RO#: P&amp;A CODE:            HOURS:            DATE: MILEAGE:</p>	<p style="text-align: center;">DEALER VALIDATION:</p> <p>RO#: P&amp;A CODE:            HOURS:            DATE: MILEAGE:</p>
<p style="text-align: center;">DEALER VALIDATION:</p> <p>RO#: P&amp;A CODE:            HOURS:            DATE: MILEAGE:</p>	<p style="text-align: center;">DEALER VALIDATION:</p> <p>RO#: P&amp;A CODE:            HOURS:            DATE: MILEAGE:</p>

## Scheduled Maintenance

### SPECIAL OPERATING CONDITIONS

If you operate your vehicle **primarily** in one of the more demanding conditions listed below, you will need to have some items maintained more frequently. If you only **occasionally** operate your vehicle under these conditions, it is not necessary to perform the additional maintenance. For specific recommendations, see your dealership service advisor or technician.

#### Towing a trailer or using a camper or car-top carrier

**Inspect frequently, service as required** – Inspect and lubricate U-joints  
– See axle maintenance items under *Exceptions*

**Every 5,000 miles (8,000 km)** – Inspect wheels and related components for abnormal noise, wear, looseness or drag  
– Rotate tires, inspect tires for wear and measure tread depth

**Every 5,000 miles (8,000 km) or 6 months** – Change engine oil and filter  
– Inspect and lubricate U-joints

**Every 30,000 miles (48,000 km)** – Change automatic transmission fluid (except 6R80 transmission)

**Every 60,000 miles (96,000 km)** – Change manual transmission fluid

## Scheduled Maintenance

### **Extensive idling and/or low-speed driving for long distances as in heavy commercial use such as delivery, taxi, patrol car or livery**

<b>Inspect frequently, service as required</b>	<ul style="list-style-type: none"><li>– Replace cabin air filter (if equipped)</li><li>– Replace engine air filter</li></ul>
<b>Every 5,000 miles (8,000 km)</b>	<ul style="list-style-type: none"><li>– Inspect brake system</li><li>– Inspect wheels and related components for abnormal noise, wear, looseness or drag</li><li>– Lubricate control arm and steering ball joints if equipped with grease fittings</li><li>– Rotate tires, inspect tires for wear and measure tread depth</li></ul>
<b>Every 5,000 miles (8,000 km) or 6 months</b>	<ul style="list-style-type: none"><li>– Inspect and lubricate U-joints</li></ul>
<b>Every 5,000 miles (8,000 km), 6 months or 200 hours of engine operation</b>	<ul style="list-style-type: none"><li>– Change engine oil and filter</li></ul>
<b>Every 15,000 miles (24,000 km)</b>	<ul style="list-style-type: none"><li>– Replace fuel filter (Crown Victoria, Grand Marquis and Town Car)</li></ul>
<b>Every 30,000 miles (48,000 km)</b>	<ul style="list-style-type: none"><li>– Change automatic transmission fluid (except 6R80 transmission)</li></ul>
<b>Every 60,000 miles (96,000 km)</b>	<ul style="list-style-type: none"><li>– Replace spark plugs</li></ul>

## Scheduled Maintenance

### **Crown Victoria police interceptor & taxi, and Executive Series Town Car equipped with engine idle hour meter**

**Inspect frequently, service as required** – Replace cabin air filter (if equipped)

**Every 5,000 miles (8,000 km)** – Inspect brake system  
– Inspect wheels and related components for abnormal noise, wear, looseness or drag  
– Lubricate control arm and steering ball joints if equipped with grease fittings  
– Rotate tires, inspect tires for wear and measure tread depth

**Every 5,000 miles (8,000 km) or 6 months** – Inspect and lubricate U-joints

**Every 5,000 miles (8,000 km), 6 months or as indicated by time/mileage calculation** – Change engine oil and filter (see description below)

**Every 15,000 miles (24,000 km)** – Replace fuel filter

**Every 30,000 miles (48,000 km)** – Change automatic transmission fluid (except 6R80 transmission)

**Every 60,000 miles (96,000 km)** – Replace spark plugs



## Scheduled Maintenance

### ENGINE IDLE HOUR METER (IF EQUIPPED):

Your vehicle may be equipped with an idle meter to indicate how much time the vehicle is idling in P (Park) or N (Neutral). The meter is incorporated with the vehicle odometer. Depressing the odometer-reset button once will display the trip odometer (miles [km] followed by a “T” for trip odometer); depressing the odometer-reset button a second time will display the idle meter (hours followed by an “H” for hours). The idle meter only accumulates time when the vehicle is in P (Park) or N (Neutral). Displayed time is cumulative for the vehicle. **It cannot be reset to zero.** Police/Fleet vehicles often experience long periods of idling, during which engine oil will continue to break down but distance is not accumulated on the odometer.

To assist fleet managers in maintaining proper oil change intervals, the idle meter will help determine when an oil change is required. For every hour that the vehicle idles, it has accumulated the equivalent of approximately 33 miles (53 km) of driving. Using the combination of the vehicle odometer and idle meter allows the fleet manager to better determine when the oil needs to be changed

#### Engine idle hour meter calculation:

Idle hours x 33 = miles (km) equivalency

Miles (km) driven + miles (km) equivalency = oil change interval

**Example:** When the odometer has accumulated 3,000 miles (4,800 km) and the idle meter shows 61 hours, a 5,000 mile (8,000 km) oil change interval will have been reached: 3,000 road miles (4,800 road km) + (61 idle hours x 33 miles [53 km]/idle hour) = 5,013 miles (8,067 km).

## Scheduled Maintenance

### Operating in dusty conditions such as unpaved or dusty roads

- |   |   |
|---|---|
| <b>Inspect frequently, service as required</b>  | – Replace cabin air filter (if equipped)<br>– Replace engine air filter   |
| <b>Every 5,000 miles (8,000 km)</b>             | – Inspect wheels and related components for abnormal noise, wear, looseness or drag<br>– Rotate tires, inspect tires for wear and measure tread depth |
| <b>Every 5,000 miles (8,000 km) or 6 months</b> | – Change engine oil and filter<br>– Inspect and lubricate U-joints  |
| <b>Every 15,000 miles (24,000 km)</b>           | – Replace fuel filter (Crown Victoria, Grand Marquis and Town Car)  |
| <b>Every 30,000 miles (48,000 km)</b>           | – Change automatic transmission fluid (except 6R80 transmission)  |
| <b>Every 50,000 miles (80,000 km)</b>           | – Change manual transmission fluid  |

### Exclusive use of E85 (Flex Fuel Vehicles only)

- |                                  |   |
|----------------------------------|---|
| <b>Every oil change interval</b> | – If ran exclusively on E85, fill the fuel tank full with regular unleaded fuel |
|----------------------------------|---|

## Scheduled Maintenance

### Special operating condition log

<p style="text-align: center;">DEALER VALIDATION:</p> <p>RO#:                    P&amp;A CODE:                                      HOURS:            DATE:                MILEAGE:</p>	<p style="text-align: center;">DEALER VALIDATION:</p> <p>RO#:                    P&amp;A CODE:                                      HOURS:            DATE:                MILEAGE:</p>
<p style="text-align: center;">DEALER VALIDATION:</p> <p>RO#:                    P&amp;A CODE:                                      HOURS:            DATE:                MILEAGE:</p>	<p style="text-align: center;">DEALER VALIDATION:</p> <p>RO#:                    P&amp;A CODE:                                      HOURS:            DATE:                MILEAGE:</p>
<p style="text-align: center;">DEALER VALIDATION:</p> <p>RO#:                    P&amp;A CODE:                                      HOURS:            DATE:                MILEAGE:</p>	<p style="text-align: center;">DEALER VALIDATION:</p> <p>RO#:                    P&amp;A CODE:                                      HOURS:            DATE:                MILEAGE:</p>
<p style="text-align: center;">DEALER VALIDATION:</p> <p>RO#:                    P&amp;A CODE:                                      HOURS:            DATE:                MILEAGE:</p>	<p style="text-align: center;">DEALER VALIDATION:</p> <p>RO#:                    P&amp;A CODE:                                      HOURS:            DATE:                MILEAGE:</p>
<p style="text-align: center;">DEALER VALIDATION:</p> <p>RO#:                    P&amp;A CODE:                                      HOURS:            DATE:                MILEAGE:</p>	<p style="text-align: center;">DEALER VALIDATION:</p> <p>RO#:                    P&amp;A CODE:                                      HOURS:            DATE:                MILEAGE:</p>

## Scheduled Maintenance

<p style="text-align: center;">DEALER VALIDATION:</p>  <p style="text-align: center;">P&amp;A CODE:</p> <p>RO#:            HOURS:</p> <p>DATE:           MILEAGE:</p>	<p style="text-align: center;">DEALER VALIDATION:</p>  <p style="text-align: center;">P&amp;A CODE:</p> <p>RO#:            HOURS:</p> <p>DATE:           MILEAGE:</p>
<p style="text-align: center;">DEALER VALIDATION:</p>  <p style="text-align: center;">P&amp;A CODE:</p> <p>RO#:            HOURS:</p> <p>DATE:           MILEAGE:</p>	<p style="text-align: center;">DEALER VALIDATION:</p>  <p style="text-align: center;">P&amp;A CODE:</p> <p>RO#:            HOURS:</p> <p>DATE:           MILEAGE:</p>
<p style="text-align: center;">DEALER VALIDATION:</p>  <p style="text-align: center;">P&amp;A CODE:</p> <p>RO#:            HOURS:</p> <p>DATE:           MILEAGE:</p>	<p style="text-align: center;">DEALER VALIDATION:</p>  <p style="text-align: center;">P&amp;A CODE:</p> <p>RO#:            HOURS:</p> <p>DATE:           MILEAGE:</p>
<p style="text-align: center;">DEALER VALIDATION:</p>  <p style="text-align: center;">P&amp;A CODE:</p> <p>RO#:            HOURS:</p> <p>DATE:           MILEAGE:</p>	<p style="text-align: center;">DEALER VALIDATION:</p>  <p style="text-align: center;">P&amp;A CODE:</p> <p>RO#:            HOURS:</p> <p>DATE:           MILEAGE:</p>
<p style="text-align: center;">DEALER VALIDATION:</p>  <p style="text-align: center;">P&amp;A CODE:</p> <p>RO#:            HOURS:</p> <p>DATE:           MILEAGE:</p>	<p style="text-align: center;">DEALER VALIDATION:</p>  <p style="text-align: center;">P&amp;A CODE:</p> <p>RO#:            HOURS:</p> <p>DATE:           MILEAGE:</p>

## Scheduled Maintenance

### EXCEPTIONS

In addition, there are several exceptions to the Normal Schedule. They are listed below:

#### Normal vehicle axle maintenance

- Rear axles and power take-off (PTO) units containing synthetic fluid and light duty trucks equipped with Ford-design axles are lubricated for life. These fluids are not to be checked or changed unless a leak is suspected, service is required or the axle assembly has been submerged in water. The axle and PTO fluids should be changed anytime the axle and PTO have been submerged in water. During extended trailer tow operation above 70°F (21°C) ambient and wide open throttle for extended periods above 45 mph (72 km/h), non-synthetic rear axle fluids should be changed every 3,000 miles (4,800 km) or three months, whichever occurs first. The 3,000 mile (4,800 km) fluid change interval may be waived if the axle was filled with 75W140 synthetic gear fluid meeting Ford specification WSL-M2C192-A, part number FITZ-19580-B or equivalent. Add friction modifier XL-3 (EST-M2C118-A) or equivalent for complete refill of Traction-Lok rear axles (refer to *Maintenance product specifications and capacities* in the *Maintenance and Specifications* chapter for details). The axle fluid should be changed anytime an axle has been submerged in water.

#### Police/Taxi/Livery vehicle axle maintenance

- Change rear axle fluid every 100,000 miles (160,000 km). Rear axle fluid change may be waived if the axle was filled with 75W140 synthetic gear fluid meeting Ford specification WSL-M2C192-A, part number FITZ-19580-B or equivalent. Add four ounces (118 mL) of friction modifier XL-3 (EST-M2C118-A) or equivalent for complete refill of Traction-Lok rear axles. The axle fluid should be changed anytime the axle has been submerged in water.

#### California fuel filter replacement

- If the vehicle is registered in California, the California Air Resources Board has determined that the failure to perform this maintenance item will not nullify the emission warranty or limit recall liability prior to the completion of the vehicle's useful life. Ford Motor Company, however, urges you to have all recommended maintenance services performed at the specified intervals and to record all vehicle service.

## Scheduled Maintenance

### Middle East hot climate specifications

- If operating conditions are normal and you drive your vehicle under typical, everyday conditions **and** you are using an API performance category oil of SL or later (for example SM, etc.) then you can follow the 7,500 mile (12,000 km) normal service oil change intervals schedule. Vehicles operating in the Middle East, North Africa, Sub-Saharan Africa or locations with similar climates must follow the oil change interval of 3,000 mile (4,800 km) if the owner is using oils defined by the American Petroleum Institute (API) performance category of API SK or earlier (for example SJ, etc.).
- Edge/MKX AWD only** – vehicles operating off-road in sand during high ambient temperatures must replace the AWD PTU (All-wheel drive Power Transfer Unit) lube every 20,000 miles (32,000 km).

### Engine air filter & cabin air filter replacement

- Engine air filter and cabin air filter life is dependent on exposure to dusty and dirty conditions. Vehicles operated in these conditions will require frequent inspection and replacement of the engine air filter and cabin air filter.

## Scheduled Maintenance

### ENGINE COOLANT CHANGE RECORD

Initial change	6 years or 105,000 miles (168,000 km) (whichever comes first)
After initial change	Every 3 years or 45,000 miles (72,000 km)

### Engine coolant change log

<p style="text-align: center;">DEALER VALIDATION:</p>  <p style="text-align: center;">P&amp;A CODE:</p> <p>RO#:            HOURS:</p> <p>DATE:          MILEAGE:</p>	<p style="text-align: center;">DEALER VALIDATION:</p>  <p style="text-align: center;">P&amp;A CODE:</p> <p>RO#:            HOURS:</p> <p>DATE:          MILEAGE:</p>
<p style="text-align: center;">DEALER VALIDATION:</p>  <p style="text-align: center;">P&amp;A CODE:</p> <p>RO#:            HOURS:</p> <p>DATE:          MILEAGE:</p>	<p style="text-align: center;">DEALER VALIDATION:</p>  <p style="text-align: center;">P&amp;A CODE:</p> <p>RO#:            HOURS:</p> <p>DATE:          MILEAGE:</p>
<p style="text-align: center;">DEALER VALIDATION:</p>  <p style="text-align: center;">P&amp;A CODE:</p> <p>RO#:            HOURS:</p> <p>DATE:          MILEAGE:</p>	<p style="text-align: center;">DEALER VALIDATION:</p>  <p style="text-align: center;">P&amp;A CODE:</p> <p>RO#:            HOURS:</p> <p>DATE:          MILEAGE:</p>

## Index

### A

ABS (see Brakes) .....180  
Accessory delay .....68  
Airbags (police) .....290  
Airbag supplemental restraint system .....112, 122  
    and child safety seats .....114  
    description .....112, 122  
    disposal .....124  
    driver airbag .....115, 123  
    indicator light .....122, 124  
    operation .....115, 123  
    passenger airbag .....115, 123  
    side airbag .....122  
Air cleaner filter .....260, 263  
Air conditioning .....44  
Air suspension .....184  
    description .....184  
Alternator .....273  
Antifreeze  
    (see Engine coolant) .....238  
Anti-lock brake system  
    (see Brakes) .....180–181  
Anti-theft system .....84  
Audio system  
    (see Radio) .....26, 28, 32, 37  
Automatic transmission  
    driving an automatic  
    overdrive .....186  
    fluid, adding .....257  
    fluid, checking .....257  
    fluid, refill capacities .....264  
    fluid, specification .....264  
    Police and fleet vehicles .....270  
Auxiliary power point .....67

### Axle

lubricant specifications .....264  
Police and fleet vehicles .....272  
refill capacities .....264  
traction lok .....185

### B

Battery .....236  
    acid, treating emergencies .....236  
    jumping a disabled battery .....208  
    maintenance-free .....236  
    Police vehicles .....272  
    replacement, specifications .....263  
    servicing .....236  
Belt-Minder® .....107  
Booster seats .....139  
Brakes .....179–180  
    anti-lock .....180–181  
    anti-lock brake system (ABS)  
    warning light .....181  
    fluid, checking and adding .....257  
    fluid, refill capacities .....264  
    fluid, specifications .....264  
    lubricant specifications .....264  
    police .....281  
    shift interlock .....185  
Bulbs .....53

### C

Capacities for refilling fluids .....264  
Cell phone use .....9  
Changing a tire .....201  
Child safety seats .....129  
    attaching with tether straps .....137  
    in front seat .....129  
    in rear seat .....129, 133  
    LATCH .....134  
    recommendations .....127



## Index

- Child safety seats - booster seats .....139
  - Cleaning your vehicle
    - engine compartment .....222
    - instrument panel .....224
    - interior .....225
    - plastic parts .....223
    - washing .....221
    - waxing .....221
    - wheels .....222
    - wiper blades .....224
  - Climate control (see Air conditioning or Heating) .....44
  - Clock adjust
    - 6-CD in dash .....40
    - AM/FM .....27
    - AM/FM/CD .....30
    - AM/FM/Tape/CD .....35
  - Console .....67
  - Controls
    - power seat .....93
    - steering column .....72
  - Coolant
    - checking and adding .....238
    - refill capacities .....241, 264
    - specifications .....264
  - Cooler .....275
  - Cruise control (see Speed control) .....71
  - Cupholder(s) .....97
  - Customer Assistance .....190
    - Ford Extended Service Plan .....302, 305
    - Getting assistance outside the U.S. and Canada .....217
    - Getting roadside assistance ...190
    - Getting the service you need .....213
  - Ordering additional owner's literature .....219
  - Utilizing the Mediation/Arbitration Program .....217
- D**
- Daytime running lamps (see Lamps) .....48
  - Defrost
    - rear window .....46
  - Dipstick
    - automatic transmission fluid .....257
    - engine oil .....233
  - Driving under special conditions .....188
    - through water .....189
- E**
- Electronic message center .....19
  - Emergencies, roadside
    - jump-starting .....208
  - Emergency Flashers .....191
  - Emission control system .....254
  - Engine .....267
    - cleaning .....222
    - coolant .....238
    - fail-safe cooling .....242
    - idle speed control .....236
    - lubrication specifications .....264
    - refill capacities .....264
    - service points .....231-232
    - starting after a collision .....192
  - Engine block heater .....178

## Index

- Engine oil .....233  
change oil soon warning,  
message center .....233  
checking and adding .....233  
dipstick .....233  
filter, specifications .....235, 263  
recommendations .....235  
refill capacities .....264  
specifications .....264
- Event data recording .....7
- Exhaust fumes .....177
- F**
- Fail safe cooling .....242
- Fire suppression system  
(police) .....286, 288
- Flexible Fuel Vehicle (FFV) ....244
- Floor mats .....73
- Fluid capacities .....264
- Fog lamps .....48
- Fuel .....244  
calculating fuel  
economy .....23, 251  
cap .....247  
capacity .....264  
choosing the right fuel .....248  
detergent in fuel .....249  
filling your vehicle with  
fuel .....244, 247, 251  
filter, specifications .....244, 263  
fuel pump shut-off switch ....192  
improving fuel economy .....251  
octane rating .....249, 267  
quality .....249  
running out of fuel .....250  
safety information relating to  
automotive fuels .....244
- Fuel - flex fuel vehicle  
(FFV) .....244, 248–249
- Fuses .....193
- G**
- Gas cap (see Fuel cap) .....247
- Gas mileage  
(see Fuel economy) .....251
- Gauges .....17
- H**
- Hazard flashers .....191
- Headlamps .....47  
aiming .....49, 51  
autolamp system .....47  
bulb specifications .....54  
daytime running lights .....48  
flash to pass .....48  
high beam .....48  
replacing bulbs .....55, 60  
turning on and off .....47
- Heating  
heating and air conditioning  
system .....43–44
- Hood .....230
- I**
- Idle Meter .....271
- Ignition .....174, 267
- Illuminated visor mirror .....66
- Infant seats  
(see Safety seats) .....129
- Inspection/maintenance (I/M)  
testing .....256

## Index

- Instrument panel  
  cleaning .....224  
  cluster .....12  
  lighting up panel and  
  interior .....49
- J**
- Jack .....201  
  positioning .....201  
  storage .....201
- Jump-starting your vehicle .....208
- K**
- Keyless entry system .....82  
  autolock .....74  
  keypad .....82  
  programming entry code .....82
- Keys .....74, 87  
  positions of the ignition .....174
- L**
- Lamps  
  autolamp system .....47  
  bulb replacement  
  specifications chart .....54  
  daytime running light .....48  
  fog lamps .....48  
  headlamps .....47  
  headlamps, flash to pass .....48  
  instrument panel, dimming ....49  
  interior lamps .....52–54  
  Police red/white map light ....282  
  replacing bulbs .....55, 60
- LATCH anchors .....134
- Lights, warning and indicator ....12  
  anti-lock brakes (ABS) .....181
- Limited slip axle  
(see Traction Loc) .....185
- Load limits .....163
- Locks  
  autolock .....74  
  childproof .....76  
  doors .....74
- Lubricant specifications .....264
- Lug nuts .....207
- Lumbar support, seats .....95
- M**
- Message center .....19–20  
  english/metric button .....23  
  system check button .....23  
  warning messages .....23
- Mirrors .....69  
  automatic dimming rearview  
  mirror .....69  
  fold away .....70  
  heated .....70  
  side view mirrors (power) .....69
- Mobile media system  
  Police and fleet vehicles .....282
- Motorcraft® parts .....228, 244, 263
- O**
- Octane rating .....249
- Oil (see Engine oil) .....233
- P**
- Parking brake .....182
- Parts  
(see Motorcraft® parts) .....263
- Passenger Occupant  
Classification Sensor .....99

## Index

- Pedals (see Power adjustable foot pedals) .....70
- Power adjustable foot pedals .....70
- Power distribution box (see Fuses) .....196
- Power distribution connector (police and fleet vehicles) .....273
- Power door locks .....74
- Power mirrors .....69
- Power point .....67
- Rear (police) .....274
- Power steering .....184
- fluid, checking and adding .....256
- fluid, refill capacity .....264
- Power Windows .....68
- R**
- Radio .....26, 28, 32, 37
- Rear window defroster .....46
- Recommendations for attaching safety restraints for children .....127
- Relays .....193, 200
- Remote entry system .....78
- illuminated entry .....81
- locking/unlocking doors .....78
- opening the trunk .....79
- panic alarm .....79
- replacement/additional transmitters .....80
- replacing the batteries .....79
- Roadside assistance .....190
- S**
- Safety belts (see Safety restraints) .....97, 102, 104–106
- 332
- Safety Canopy .....122
- Safety defects, reporting .....220
- Safety restraints .....97, 102–106
- Belt-Minder® .....107
- extension assembly .....106
- for adults .....102, 104–105
- for children .....125
- lap belt .....103
- Occupant Classification Sensor .....99
- warning light and chime .....106–107
- Safety restraints - LATCH anchors .....134
- Safety seats for children .....129
- Safety Compliance Certification Label .....268
- Scheduled Maintenance Guide
- Normal Scheduled Maintenance and Log .....311
- Seat belt extenders (police) ....281
- Seats .....89
- child safety seats .....129
- cleaning .....226
- front seats .....91
- heated .....96
- Heavy duty (police) .....281
- SecuriLock passive anti-theft system .....84, 87
- Servicing your vehicle .....229
- Setting the clock
- AM/FM/In-dash 6 CD .....40
- AM/FM single CD .....30
- AM/FM stereo .....27
- AM/FM/Tape/CD .....35
- Spark plugs, specifications .....263, 267

<https://www.MyCarManual.com>

## Index

- Specification chart, lubricants .....264
- Speed control .....71
- Speedometer
  - calibrated (police) .....282
- Starting a flex fuel vehicle .....176
- Starting your vehicle .....174–176
  - jump starting .....208
- Steering wheel
  - controls .....72
  - tilting .....66
- Suspension
  - heavy duty (police) .....275
- T**
- Tilt steering wheel .....66
- Tire Pressure Monitoring System (TPMS)
  - Tires, Wheels and Loading ....158
  - Police and fleet vehicles .....276
- Tires .....143–144, 201
  - alignment .....151
  - care .....147
  - changing .....201, 205
  - checking the pressure .....147
  - inflating .....145
  - label .....157
  - police vehicles .....276
  - replacing .....149
  - rotating .....151
  - safety practices .....150
  - sidewall information .....152
  - snow tires and chains .....163
  - spare tire .....201, 203
  - terminology .....144
  - tire grades .....144
  - treadwear .....143, 148
- Towing .....170
  - recreational towing .....173
  - trailer towing .....170
  - wrecker .....211
- Traction control .....183
- Traction-lok rear axle .....185
- Transmission .....186
  - brake-shift interlock (BSI) ....185
  - fluid, checking and adding (automatic) .....257
  - fluid, refill capacities .....264
  - lubricant specifications .....264
- Trunk .....76
  - Pack and loading .....284
  - remote release .....73, 79
- Turn signal .....52
- V**
- Vehicle Identification Number (VIN) .....268
- Vehicle loading .....163
- Ventilating your vehicle .....177
- W**
- Warning lights (see Lights) .....12
- Washer fluid .....232
- Water, Driving through .....189
- Windows
  - power .....68
- Windshield washer fluid and wipers .....65
  - checking and adding fluid ....232
  - replacing wiper blades .....232
- Wrecker towing .....211