



fordowner.com



ford.ca

2014 **FIESTA** Owner's Manual



The information contained in this publication was correct at the time of going to print. In the interest of continuous development, we reserve the right to change specifications, design or equipment at any time without notice or obligation. No part of this publication may be reproduced, transmitted, stored in a retrieval system or translated into any language in any form by any means without our written permission. Errors and omissions excepted.

© Ford Motor Company 2013

All rights reserved.

Part Number: 20130920230619



# Table of Contents

---

## Introduction

About This Manual.....	7
Symbols Glossary.....	7
Replacement Parts Recommendation.....	9
Mobile Communications Equipment.....	10
Data Recording.....	10
California Proposition 65.....	12
Perchlorate.....	12
Ford Credit.....	12
Special Notices.....	12
Export Unique Options.....	12

## Child Safety

General Information.....	14
Installing Child Seats.....	15
Child Seat Positioning.....	21
Booster Seats.....	23
Child Safety Locks.....	25

## Safety Belts

Principle of Operation.....	26
Fastening the Safety Belts.....	27
Safety Belt Height Adjustment.....	29
Safety Belt Warning Lamp and Indicator Chime.....	30
Safety Belt Minder.....	30
Child Restraint and Safety Belt Maintenance.....	32

## Personal Safety System™

Personal Safety System™.....	33
------------------------------	----

## Supplementary Restraints System

Principle of Operation.....	34
Driver and Passenger Airbags.....	35
Front Passenger Sensing System.....	36
Side Airbags.....	38

Knee Airbag.....	39
Side Curtain Airbags.....	39
Crash Sensors and Airbag Indicator.....	41
Airbag Disposal.....	42

## Keys and Remote Controls

General Information on Radio Frequencies.....	43
Remote Control.....	43
Replacing a Lost Key or Remote Control.....	47

## MyKey™

Principle of Operation.....	48
Creating a MyKey.....	48
Clearing All MyKeys.....	49
Checking MyKey System Status.....	49
Using MyKey With Remote Start Systems.....	50
MyKey Troubleshooting.....	50

## Locks

Locking and Unlocking.....	52
Manual Liftgate.....	55
Keyless Entry.....	56
Interior Luggage Compartment Release.....	58

## Security

Passive Anti-Theft System.....	60
Anti-Theft Alarm.....	61

## Steering Wheel

Adjusting the Steering Wheel.....	63
Audio Control.....	63
Voice Control.....	64
Cruise Control.....	64

## Wipers and Washers

Windshield Wipers.....	65
------------------------	----

# Table of Contents

---

Windshield Washers.....	65
Rear Window Wiper and Washers.....	66

## Lighting

General Information.....	67
Lighting Control.....	67
Autolamps.....	68
Instrument Lighting Dimmer.....	68
Headlamp Exit Delay.....	69
Daytime Running Lamps.....	69
Front Fog Lamps.....	69
Direction Indicators.....	69
Interior Lamps.....	70
Ambient Lighting.....	71

## Windows and Mirrors

Power Windows.....	72
Global Opening and Closing.....	73
Exterior Mirrors.....	74
Interior Mirror.....	75
Moonroof.....	76

## Instrument Cluster

Gauges.....	77
Warning Lamps and Indicators.....	78
Warning Lamps and Indicators - 1.6L EcoBoost™.....	81
Audible Warnings and Indicators.....	84

## Information Displays

General Information.....	85
Clock.....	88
Trip Computer.....	88
Personalized Settings.....	89
Information Messages.....	89

## Climate Control

Principle of Operation.....	97
Air Vents.....	97

Manual Climate Control.....	98
Automatic Climate Control.....	99
Hints on Controlling the Interior Climate.....	100
Heated Windows and Mirrors.....	103
Cabin Air Filter.....	103

## Seats

Sitting in the Correct Position.....	105
Head Restraints.....	105
Manual Seats.....	107
Rear Seats.....	108
Heated Seats.....	109

## Auxiliary Power Points

Auxiliary Power Points.....	111
Cigar Lighter.....	111

## Storage Compartments

Cup Holders.....	112
------------------	-----

## Starting and Stopping the Engine

General Information.....	113
Ignition Switch.....	113
Keyless Starting.....	113
Starting a Gasoline Engine.....	115
Switching Off the Engine.....	116
Engine Block Heater.....	116

## Fuel and Refueling

Safety Precautions.....	118
Fuel Quality.....	119
Running Out of Fuel.....	119
Refueling.....	120
Fuel Consumption.....	122
Emission Control System.....	123

## Transmission

Manual Transmission.....	126
--------------------------	-----

# Table of Contents

---

Manual Transmission - 1.6L EcoBoost™ .....	127
Automatic Transmission.....	128
Hill Start Assist.....	132

## Brakes

General Information.....	134
Hints on Driving With Anti-Lock Brakes.....	134
Parking Brake.....	134

## Stability Control

Principle of Operation.....	136
Using Stability Control.....	137
Using Stability Control - 1.6L EcoBoost™ .....	137

## Parking Aids

Principle of Operation.....	138
Parking Aid.....	138
Rear View Camera.....	139

## Cruise Control

Principle of Operation.....	142
Using Cruise Control.....	142

## Driving Aids

Steering.....	144
---------------	-----

## Load Carrying

General Information.....	145
Load Limit.....	145
Rear Under Floor Storage.....	152
Cargo Nets.....	153
Luggage Covers.....	153

## Towing

Towing a Trailer - 1.6L EcoBoost™ .....	154
Transporting the Vehicle.....	154
Towing the Vehicle on Four Wheels.....	154

## Driving Hints

Breaking-In.....	157
Cold Weather Precautions.....	157
Driving Through Water.....	157
Economical Driving.....	157
Floor Mats.....	158

## Customer Assistance

Getting the Services You Need.....	160
In California (U.S. Only).....	161
The Better Business Bureau (BBB) Auto Line Program (U.S. Only).....	162
Utilizing the Mediation/Arbitration Program (Canada Only).....	162
Getting Assistance Outside the U.S. and Canada.....	163
Ordering Additional Owner's Literature.....	164
Reporting Safety Defects (U.S. Only).....	164
Reporting Safety Defects (Canada Only).....	165

## Roadside Emergencies

Roadside Assistance.....	166
Hazard Warning Flashers.....	167
Fuel Shutoff.....	167
Jump-Starting the Vehicle.....	167

## Fuses

Fuse Specification Chart.....	169
Changing a Fuse.....	175

## Maintenance

General Information.....	177
Opening and Closing the Hood.....	177
Under Hood Overview - 1.0L EcoBoost™ .....	179
Under Hood Overview - 1.6L Duratec-16V Ti-VCT (88kW/120PS) - Sigma.....	180

# Table of Contents

Under Hood Overview - 1.6L EcoBoost™	181	Cleaning the Instrument Panel and Instrument Cluster Lens	207
Engine Oil Dipstick - 1.0L EcoBoost™	182	Cleaning Leather Seats	207
Engine Oil Dipstick - 1.6L Duratec-16V Ti-VCT (88kW/120PS) - Sigma	182	Cleaning the Alloy Wheels	208
Engine Oil Dipstick - 1.6L EcoBoost™	182	Vehicle Storage	208
Engine Oil Check	182	<b>Wheels and Tires</b>	
Engine Coolant Check	183	General Information	211
Automatic Transmission Fluid Check	185	Tire Care	211
Brake Fluid Check	185	Using Winter Tires	226
Power Steering Fluid Check	185	Using Snow Chains	226
Fuel Filter	186	Tire Pressure Monitoring System	226
Washer Fluid Check	186	Changing a Road Wheel	230
Changing the 12V Battery	186	Technical Specifications	234
Checking the Wiper Blades	186	<b>Capacities and Specifications</b>	
Changing the Wiper Blades	186	Engine Specifications	235
Changing the Engine Air Filter	187	Motorcraft Parts	236
Adjusting the Headlamps	188	Vehicle Identification Number	237
Removing a Headlamp	189	Vehicle Certification Label	237
Changing a Bulb	190	Transmission Code Designation	238
Changing a Bulb	194	<b>Accessories</b>	
Bulb Specification Chart	199	Accessories	239
Technical Specifications - 1.0L EcoBoost™	200	<b>Ford Extended Service Plan (ESP)</b>	
Technical Specifications - 1.6L EcoBoost™	201	Ford Extended Service Plan (ESP)	241
Technical Specifications - 1.6L Duratec-16V Ti-VCT (Sigma)	202	<b>Audio System</b>	
<b>Vehicle Care</b>		General Information	244
Cleaning Products	204	Audio unit - Vehicles With: AM/FM/CD	245
Cleaning the Exterior	204	Audio unit - Vehicles With: AM/FM/CD/SYNC	249
Waxing	205	Audio unit - Vehicles With: Touchscreen Display	254
Cleaning the Engine	205	Audio unit - Vehicles With: Sony Audio System/Touchscreen Display	255
Cleaning the Windows and Wiper Blades	206	Auxiliary Input Jack	257
Cleaning the Interior	206		
Repairing Minor Paint Damage	206		

# Table of Contents

---

Audio Troubleshooting.....258

## **SYNC™**

General Information.....259  
Using Voice Recognition.....261  
Using SYNC™ With Your Phone.....263  
SYNC™ Applications and Services.....274  
Using SYNC™ With Your Media  
Player.....281  
SYNC™ Troubleshooting.....289

## **MyFord Touch™**

General Information.....295  
Settings.....303  
Entertainment.....313  
Phone.....331  
Information.....337  
Navigation.....346

## **Appendices**

End User License Agreement.....356

## **Scheduled Maintenance**

Scheduled Maintenance.....371





# Introduction

## ABOUT THIS MANUAL

Thank you for choosing Ford. We recommend that you take some time to get to know your vehicle by reading this manual. The more that you know about it, the greater the safety and pleasure you will get from driving it.

### WARNING



Driving while distracted can result in loss of vehicle control, crash and injury. We strongly recommend that you use extreme caution when using any device that may take your focus off the road. Your primary responsibility is the safe operation of your vehicle. We recommend against the use of any handheld device while driving and encourage the use of voice-operated systems when possible. Make sure you are aware of all applicable local laws that may affect the use of electronic devices while driving.

**Note:** *This manual describes product features and options available throughout the range of available models, sometimes even before they are generally available. It may describe options not fitted to your vehicle.*

**Note:** *Some of the illustrations in this manual may be used for different models, so may appear different to you on your vehicle. However, the essential information in the illustrations is always correct.*

**Note:** *Always use and operate your vehicle in line with all applicable laws and regulations.*

**Note:** *Pass on this manual when selling your vehicle. It is an integral part of the vehicle.*

This manual may qualify the location of a component as left-hand side or right-hand side. The side is determined when facing forward in the seat.



E154903

- A Right-hand side
- B Left-hand side

## Protecting the Environment

You must play your part in protecting the environment. Correct vehicle usage and the authorized disposal of waste, cleaning and lubrication materials are significant steps toward this aim.

## SYMBOLS GLOSSARY

These are some of the symbols you may see on your vehicle.



Safety alert



See Owner's Manual



Air conditioning system



Anti-lock braking system



Avoid smoking, flames or sparks

# Introduction

---



Battery



Engine oil



Battery acid



Explosive gas



Brake fluid - non petroleum based



Fan warning



Brake system



Fasten safety belt



Cabin air filter



Front airbag



Check fuel cap



Front fog lamps



Child safety door lock or unlock



Fuel pump reset



Child seat lower anchor



Fuse compartment



Child seat tether anchor



Hazard warning flashers



Cruise control



Heated rear window



Do not open when hot



Heated windshield



Engine air filter



Interior luggage compartment release



Engine coolant



Jack



Engine coolant temperature



Keep out of reach of children



Lighting control

# Introduction

---



Low tire pressure warning



Maintain correct fluid level



Note operating instructions



Panic alarm



Parking aid



Parking brake



Power steering fluid



Power windows front/rear



Power window lockout



Service engine soon



Side airbag



Shield the eyes



Stability control



Windshield wash and wipe

## REPLACEMENT PARTS RECOMMENDATION

Your vehicle has been built to the highest standards using quality parts. We recommend that you demand the use of genuine Ford and Motorcraft parts whenever your vehicle requires scheduled maintenance or repair. You can clearly identify genuine Ford and Motorcraft parts by looking for the Ford, FoMoCo or Motorcraft branding on the parts or their packaging.

## Scheduled Maintenance and Mechanical Repairs

One of the best ways for you to make sure that your vehicle provides years of service is to have it maintained in line with our recommendations using parts that conform to the specifications detailed in this Owner's Manual. Genuine Ford and Motorcraft parts meet or exceed these specifications.

## Collision Repairs

We hope that you never experience a collision, but accidents do happen. Genuine Ford replacement collision parts meet our stringent requirements for fit, finish, structural integrity, corrosion protection and dent resistance. During vehicle development we validate these parts deliver the intended level of protection as a whole system. A great way to know for sure you are getting this level of protection is to use genuine Ford replacement collision parts.

# Introduction

---

## Warranty on Replacement Parts

Genuine Ford and Motorcraft replacement parts are the only replacement parts that benefit from a Ford Warranty. Damage caused to your vehicle as a result of the failure of non-Ford parts may not be covered by the Ford Warranty. For additional information, refer to the terms and conditions of the Ford Warranty.

## MOBILE COMMUNICATIONS EQUIPMENT

Using mobile communications equipment is becoming increasingly important in the conduct of business and personal affairs. However, you must not compromise your own or others' safety when using such equipment. Mobile communications can enhance personal safety and security when appropriately used, particularly in emergency situations. Safety must be paramount when using mobile communications equipment to avoid negating these benefits. Mobile communication equipment includes, but is not limited to, cellular phones, pagers, portable email devices, text messaging devices and portable two-way radios.

### WARNING



Driving while distracted can result in loss of vehicle control, crash and injury. We strongly recommend that you use extreme caution when using any device that may take your focus off the road. Your primary responsibility is the safe operation of your vehicle. We recommend against the use of any hand-held device while driving and encourage the use of voice-operated systems when possible. Make sure you are aware of all applicable local laws that may affect the use of electronic devices while driving.

---

## DATA RECORDING

### Service Data Recording

Service data recorders in your vehicle are capable of collecting and storing diagnostic information about your vehicle. This potentially includes information about the performance or status of various systems and modules in the vehicle, such as engine, throttle, steering or brake systems. In order to properly diagnose and service your vehicle, Ford Motor Company, Ford of Canada, and service and repair facilities may access or share among them vehicle diagnostic information received through a direct connection to your vehicle when diagnosing or servicing your vehicle. Additionally, when your vehicle is in for service or repair, Ford Motor Company, Ford of Canada, and service and repair facilities may access or share among them data for vehicle improvement purposes. For U.S. only (if equipped), if you choose to use the SYNC Vehicle Health Report, you consent that certain diagnostic information may also be accessed electronically by Ford Motor Company and Ford authorized service facilities, and that the diagnostic information may be used for any purpose. See **SYNC™** (page 259).

### Event Data Recording

**This vehicle is equipped with an event data recorder. The main purpose of an event data recorder is to record, in certain crash or near crash-like situations, such as an airbag deployment or hitting a road obstacle; this data will assist in understanding how a vehicle's systems performed. The event data recorder is designed to record data related to vehicle dynamics and safety systems for a short period of time, typically 30 seconds or less.**

# Introduction

---

The event data recorder in this vehicle is designed to record such data as:

- How various systems in your vehicle were operating;
- Whether or not the driver and passenger safety belts were buckled/fastened;
- How far (if at all) the driver was depressing the accelerator and/or the brake pedal; and
- How fast the vehicle was traveling; and
- Where the driver was positioning the steering wheel.

This data can help provide a better understanding of the circumstances in which crashes and injuries occur.

**Note:** *Event data recorder data is recorded by your vehicle only if a non-trivial crash situation occurs; no data is recorded by the event data recorder under normal driving conditions and no personal data or information (e.g., name, gender, age, and crash location) is recorded (see Limitations regarding 911 Assist and Traffic, directions and Information privacy below). However, parties, such as law enforcement, could combine the event data recorder data with the type of personally identifying data routinely acquired during a crash investigation.*

To read data recorded by an event data recorder, special equipment is required, and access to the vehicle or the event data recorder is needed. In addition to the vehicle manufacturer, other parties, such as law enforcement, that have such special equipment, can read the information if they have access to the vehicle or the event data recorder. Ford Motor Company and Ford of Canada do not access event data recorder information without obtaining consent, unless pursuant to court order

or where required by law enforcement, other government authorities or other third parties acting with lawful authority. Other parties may seek to access the information independently of Ford Motor Company and Ford of Canada.

**Note:** *Including to the extent that any law pertaining to Event Data Recorders applies to SYNC or its features, please note the following: Once 911 Assist (if equipped) is enabled (set ON), 911 Assist may, through any paired and connected cell phone, disclose to emergency services that the vehicle has been in a crash involving the deployment of an airbag or, in certain vehicles, the activation of the fuel pump shut-off. Certain versions or updates to 911 Assist may also be capable of being used to electronically or verbally provide to 911 operators the vehicle location (such as latitude and longitude), and/or other details about the vehicle or crash or personal information about the occupants to assist 911 operators to provide the most appropriate emergency services. If you do not want to disclose this information, do not activate the 911 Assist feature. See SYNC™ (page 259).*

**Additionally, when you connect to Traffic, Directions and Information (if equipped, U.S. only), the service uses GPS technology and advanced vehicle sensors to collect the vehicle's current location, travel direction, and speed ("vehicle travel information"), only to help provide you with the directions, traffic reports, or business searches that you request. If you do not want Ford or its vendors to receive this information, do not activate the service. Ford Motor Company and the**

# Introduction

**vendors it uses to provide you with this information do not store your vehicle travel information. For more information, see Traffic, Directions and Information, Terms and Conditions.** See **SYNC™** (page 259).

## CALIFORNIA PROPOSITION 65

### WARNING



Some constituents of engine exhaust, certain vehicle components, certain fluids contained in vehicles and certain products of component wear contain or emit chemicals known to the State of California to cause cancer and birth defects or other reproductive harm.

## PERCHLORATE

Certain components in your vehicle such as airbag modules, safety belt pretensioners and remote control batteries may contain perchlorate material. Special handling may apply for service or vehicle end of life disposal. For more information visit:

Web Address
<a href="http://www.dtsc.ca.gov/hazardouswaste/perchlorate">www.dtsc.ca.gov/hazardouswaste/perchlorate</a>

## FORD CREDIT

### (U.S. Only)

Ford Credit offers a full range of financing and lease plans to help you acquire your vehicle. If you have financed or leased your vehicle through Ford Credit, thank you for your business.

For your convenience we offer a number of ways to contact us, as well as help manage your account.

Phone: 1-800-727-7000

For more information regarding Ford Credit, as well as access Account Manager, please go to [www.fordcredit.com](http://www.fordcredit.com).

## SPECIAL NOTICES

### New Vehicle Limited Warranty

For a detailed description of what is covered and what is not covered by your vehicle's New Vehicle Limited Warranty, refer to the Warranty Manual that is provided to you along with your Owner's Manual.

### Special Instructions

For your added safety, your vehicle is fitted with sophisticated electronic controls.

### WARNINGS



Failure to follow the specific warnings and instructions could result in personal injury.



Front seat mounted rear-facing child or infant seats should **NEVER** be placed in front of an active passenger airbag.

## EXPORT UNIQUE OPTIONS

For your particular global region, your vehicle may be equipped with features and options that are different from the features and options that are described in this Owner's Manual. A market unique supplement may be supplied that complements this book. By referring to the market unique supplement, if provided, you can properly identify those features, recommendations and specifications that are unique to your vehicle. This Owner's

# Introduction

---

Manual is written primarily for the U.S. and Canadian Markets. Features or equipment listed as standard may be different on units built for Export. **Refer to this Owner's Manual for all other required information and warnings.**



# Child Safety

---

## GENERAL INFORMATION

See the following sections for directions on how to properly use safety restraints for children.

### WARNINGS



Always make sure your child is secured properly in a device that is appropriate for their height, age and weight. Child safety restraints must be bought separately from your vehicle. Failure to follow these instructions and guidelines may result in an increased risk of serious injury or death to your child.



All children are shaped differently. The recommendations for safety restraints are based on probable child height, age and weight thresholds from National Highway Traffic Safety Administration and other safety organizations, or are the minimum

### WARNINGS

requirements of law. Ford recommends checking with a NHTSA Certified Child Passenger Safety Technician (CPST) and consult your pediatrician to make sure your child seat is appropriate for your child, and is compatible with and properly installed in your vehicle. To locate a child seat fitting station and CPST, contact the NHTSA toll free at 1-888-327-4236 or go to <http://www.nhtsa.dot.gov>. In Canada, check with your local St. John Ambulance office for referral to a CPST or for further information, contact your provincial ministry of transportation, locate your local St. John Ambulance office by searching for St. John Ambulance on the internet, or Transport Canada at 1-800-333-0371 (<http://www.tc.gc.ca>). Failure to properly restrain children in safety seats made especially for their height, age, and weight may result in an increased risk of serious injury or death to your child.

---

# Child Safety

## Recommendations for Safety Restraints for Children

Child	Child size, height, weight, or age	Recommended restraint type
Infants or toddlers	Children weighing 40 lb (18 kg) or less (generally age four or younger).	Use a child safety seat (sometimes called an infant carrier, convertible seat, or toddler seat).
Small children	Children who have outgrown or no longer properly fit in a child safety seat (generally children who are less than 4 ft. 9 in. (1.45 m) tall, are greater than age four and less than age 12, and between 40 lb (18 kg) and 80 lb (36 kg) and upward to 100 lb (45 kg) if recommended by your child restraint manufacturer).	Use a belt-positioning booster seat.
Larger children	Children who have outgrown or no longer properly fit in a belt-positioning booster seat (generally children who are at least 4 ft. 9 in. (1.45 m) tall or greater than 80 lb (36 kg) or 100 lb (45 kg) if recommended by child restraint manufacturer).	Use a vehicle safety belt having the lap belt snug and low across the hips, shoulder belt centered across the shoulder and chest, and seat back upright.

- You are required by law to properly use safety seats for infants and toddlers in the United States and Canada.
- Many states and provinces require that small children use approved booster seats until they reach age eight, a height of 4 feet 9 inches (1.45 meters) tall, or 80 pounds (36 kilograms). Check your local and state or provincial laws for specific requirements about the safety of children in your vehicle.
- When possible, always properly restrain children 12 years of age and under in a rear seating position of your vehicle. Accident statistics suggest that children are safer when properly restrained in the rear seating positions than in a front seating position. See **Front Passenger Sensing System** (page 36).

## INSTALLING CHILD SEATS

### Child Seats



E66920

# Child Safety

Use a child safety seat (sometimes called an infant carrier, convertible seat, or toddler seat) for infants, toddlers, or children weighing 40 pounds (18 kilograms) or less (generally age four or younger).

## Using Lap and Shoulder Belts

### WARNINGS



Airbags can kill or injure a child in a child seat. NEVER place a rear-facing child seat in front of an active airbag.

If you must use a forward-facing child seat in the front seat, move the seat all the way back.



Children 12 and under should be properly restrained in the rear seat whenever possible.



Depending on where you secure a child restraint, and depending on the child restraint design, you may block access to certain safety belt buckle assemblies and LATCH lower anchors, rendering those features potentially unusable. To avoid risk of injury, occupants should only use seating positions where they are able to be properly restrained.

When installing a child safety seat with combination lap and shoulder belts:

- Use the correct safety belt buckle for that seating position.
- Insert the belt tongue into the proper buckle until you hear a snap and feel it latch. Make sure the tongue is securely fastened in the buckle.
- Keep the buckle release button pointing up and away from the safety seat, with the tongue between the child seat and the release button, to prevent accidental unbuckling.

- Place your vehicle seat back in the upright position.
- Put the safety belt in the automatic locking mode. See Step 5. This vehicle does not require the use of a locking clip.

Perform the following steps when installing the child seat with combination lap and shoulder belts:

**Note:** Although the child seat illustrated is a forward facing child seat, the steps are the same for installing a rear facing child seat.



E142528

1. Position the child safety seat in a seat with a combination lap and shoulder belt.



E142529

2. Pull down on the shoulder belt and then grasp the shoulder belt and lap belt together.

# Child Safety



E142530

3. While holding the shoulder and lap belt portions together, route the tongue through the child seat according to the child seat manufacturer's instructions. Be sure the belt webbing is not twisted.



E142875

5. To put the retractor in the automatic locking mode, grasp the shoulder portion of the belt and pull downward until all of the belt is pulled out.

**Note:** *The automatic locking mode is available on the front passenger and rear seats. This vehicle does not require the use of a locking clip.*

6. Allow the belt to retract to remove slack. The belt will click as it retracts to indicate it is in the automatic locking mode.
7. Try to pull the belt out of the retractor to make sure the retractor is in the automatic locking mode (you should not be able to pull more belt out). If the retractor is not locked, unbuckle the belt and repeat Steps 5 and 6.

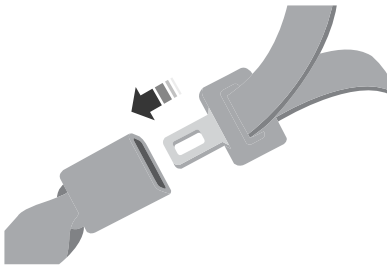

E142531

4. Insert the belt tongue into the proper buckle (the buckle closest to the direction the tongue is coming from) for that seating position until you hear a snap and feel the latch engage. Make sure the tongue is latched securely by pulling on it.



E142533

# Child Safety

- Remove remaining slack from the belt. Force the seat down with extra weight, e.g., by pressing down or kneeling on the child restraint while pulling up on the shoulder belt in order to force slack from the belt. This is necessary to remove the remaining slack that will exist once the extra weight of the child is added to the child restraint. It also helps to achieve the proper snugness of the child seat to your vehicle. Sometimes, a slight lean toward the buckle will additionally help to remove remaining slack from the belt.
- Attach the tether strap (if the child seat is equipped). See **Using Tether Straps** later in this section.

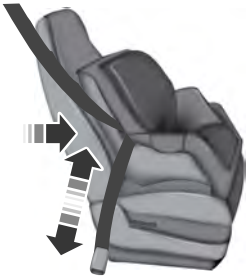

E142534

- Before placing the child in the seat, forcibly move the seat forward and back to make sure the seat is securely held in place. To check this, grab the seat at the belt path and attempt to move it side to side and forward and back. There should be no more than 1 inch (2.5 centimeters) of movement for proper installation.

Ford recommends checking with a NHTSA Certified Child Passenger Safety Technician (CPST) to make certain the child restraint is properly installed. In Canada, check with your local St. John Ambulance office for referral to a Certified Passenger Seat Technician.

## Using Lower Anchors and Tethers for Children (LATCH)

### WARNINGS

 Never attach two child safety seats to the same anchor. In a crash, one anchor may not be strong enough to hold two child safety seat attachments and may break, causing serious injury or death.

 Depending on where you secure a child restraint, and depending on the child restraint design, you may block access to certain safety belt buckle assemblies or LATCH lower anchors, rendering those features potentially unusable. To avoid risk of injury, occupants should only use seating positions where they are able to be properly restrained.

The LATCH system is composed of three vehicle anchor points: two lower anchors located where your vehicle seat back and seat cushion meet (called the seat bight) and one top tether anchor located behind that seating position.

LATCH compatible child safety seats have two rigid or webbing mounted attachments that connect to the two lower anchors at the LATCH equipped seating positions in your vehicle. This type of attachment method eliminates the need to use safety belts to attach the child seat, however the safety belt can still be used to attach the child seat. For forward-facing child seats, the top tether strap must also be attached to the proper top tether anchor, if a top tether strap has been provided with your child seat.

# Child Safety

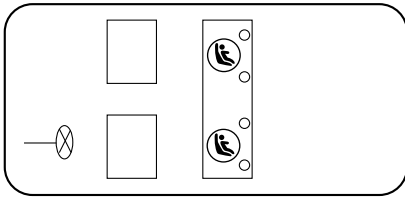

E142535

Your vehicle has LATCH lower anchors for child seat installation at the seating positions marked with the child seat symbol.



E144054

The LATCH anchors are located at the rear section of the rear seat between the cushion and seat back below the symbols as shown. Follow the child seat manufacturer's instructions to properly install a child seat with LATCH attachments. Follow the instructions on attaching child safety seats with tether straps.

Attach LATCH lower attachments of the child seat only to the anchors shown.

## Use of Inboard Lower Anchors from the Outboard Seating Positions (Center Seating Use)

### WARNING



The standardized spacing for LATCH lower anchors is 11 inches (28 centimeters) center to center. Do not use LATCH lower anchors for the center seating position unless the child seat manufacturer's instructions permit and specify using anchors spaced at least as far apart as those in this vehicle.

The lower anchors at the center of the second row rear seat are spaced 15 inches (39 centimeters) apart. A child seat with rigid LATCH attachments cannot be installed at the center seating position. LATCH compatible child seats (with attachments on belt webbing) can only be used at this seating position provided that the child seat manufacturer's instructions permit use with the anchor spacing stated. Do not attach a child seat to any lower anchor if an adjacent child seat is attached to that anchor.

Each time you use the safety seat, check that the seat is properly attached to the lower anchors and tether anchor, if applicable. Tug the child seat from side to side and forward and back where it is secured to your vehicle. The seat should move less than one inch when you do this for a proper installation.

If the safety seat is not anchored properly, the risk of a child being injured in a crash greatly increases.

# Child Safety

## Combining Safety Belt and LATCH Lower Anchors for Attaching Child Safety Seats

When used in combination, either the safety belt or the LATCH lower anchors may be attached first, provided a proper installation is achieved. Attach the tether strap afterward, if included with the child seat.

## Using Tether Straps



Many forward-facing child safety seats include a tether strap which extends from the back of the child safety seat and hooks to an anchoring point called the top tether anchor. Tether straps are available as an accessory for many older safety seats.

Contact the manufacturer of your child seat for information about ordering a tether strap, or to obtain a longer tether strap if the tether strap on your safety seat does not reach the appropriate top tether anchor in your vehicle.

Once the child safety seat has been installed using either the safety belt, the lower anchors of the LATCH system, or both, you can attach the top tether strap.

The tether strap anchors in your vehicle are in the following positions (shown from top view):

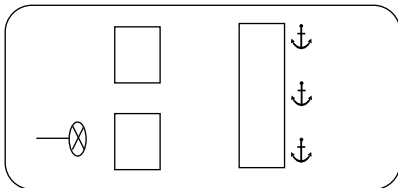

E142537

Perform the following steps to install a child safety seat with tether anchors:

**Note:** *If you install a child seat with rigid LATCH attachments, do not tighten the tether strap enough to lift the child seat off your vehicle seat cushion when the child is seated in it. Keep the tether strap just snug without lifting the front of the child seat. Keeping the child seat just touching your vehicle seat gives the best protection in a severe crash.*

## Four Door

The tether anchors in your vehicle are located under a cover marked with the tether anchor symbol.

1. Route the child safety seat tether strap over the back of the seat. For outboard seating positions, route the tether strap under the head restraint and between the head restraint posts. For the center seating positions, route the tether strap over the top of the head restraint. If needed, the head restraints can also be removed.



E144274

2. Locate the correct anchor for the selected seating position, then open the tether anchor cover.



E144275

# Child Safety

3. Clip the tether strap to the anchor as shown.
4. Tighten the child safety seat tether strap according to the manufacturer's instructions. If your child restraint system is equipped with a tether strap, and the child restraint manufacturer recommends its use, Ford also recommends its use.

## Five Door

The tether anchors in your vehicle are located on the back panel of the rear seat. These are marked with the tether anchor symbol.

1. Route the child safety seat tether strap over the back of the seat. For outboard seating positions, route the tether strap under the head restraint and between the head restraint posts. For the center seating positions, route the tether strap over the top of the head restraint. If needed, the head restraints can also be removed.



E164077

2. Locate the correct anchor on the back panel of the rear seat for the selected seating position.





E142539

3. Clip the tether strap to the anchor as shown.
4. Tighten the child safety seat tether strap according to the manufacturer's instructions. If your child restraint system is equipped with a tether strap, and the child restraint manufacturer recommends its use, Ford also recommends its use.

## CHILD SEAT POSITIONING

### WARNINGS

 Airbags can kill or injure a child in a child seat. Never place a rear-facing child seat in front of an active airbag. If you must use a forward-facing child seat in the front seat, move the vehicle seat upon which the child seat is installed all the way back. When possible, all children age 12 and under should be properly restrained in a rear seating position. If all children cannot be seated and restrained properly in a rear seating position, properly restrain the largest child in the front seat.

 Always carefully follow the instructions and warnings provided by the manufacturer of any child restraint to determine if the restraint device is appropriate for your child's size, height, weight, or age. Follow the child restraint manufacturer's instructions and warnings provided for installation and use in



# Child Safety

## WARNINGS

conjunction with the instructions and warnings provided by your vehicle manufacturer. A safety seat that is improperly installed or utilized, is inappropriate for your child's height, age, or weight or does not properly fit the child may increase the risk of serious injury or death.



Never let a passenger hold a child on his or her lap while your vehicle is moving. The passenger cannot protect the child from injury in a crash, which may result in serious injury or death.



Never use pillows, books, or towels to boost a child. They can slide around and increase the likelihood of injury or death in a crash.

## WARNINGS



Always restrain an unoccupied child seat or booster seat. These objects may become projectiles in a crash or sudden stop, which may increase the risk of serious injury.



Never place, or allow a child to place, the shoulder belt under a child's arm or behind the back because it reduces the protection for the upper part of the body and may increase the risk of injury or death in a crash.



To avoid risk of injury, do not leave children or pets unattended in your vehicle.

Restraint Type	Combined child and seat weight	Use any attachment method as indicated below by X				
		LATCH (lower anchors and top tether anchor)	LATCH (lower anchors only)	Safety belt and top tether anchor	Safety belt and LATCH (lower anchors and top tether anchor)	Safety belt only
Rear facing child seat	Up to 65 lb (29 kg)		X			X
Rear facing child seat	Over 65 lb (29 kg)					X
Forward facing child seat	Up to 65 lb (29 kg)	X		X	X	
Forward facing child seat	Over 65 lb (29 kg)			X	X	

**Note:** The child seat must rest tightly against the vehicle seat upon which it is installed. It may be necessary to lift or remove the head restraint. See **Seats** (page 105).

# Child Safety

## BOOSTER SEATS

### WARNING



Never place, or allow a child to place, the shoulder belt under a child's arm or behind the back because it reduces the protection for the upper part of the body and may increase the risk of injury or death in a crash.

Use a belt-positioning booster seat for children who have outgrown or no longer properly fit in a child safety seat (generally children who are less than 4 feet 9 inches (1.45 meters) tall, are greater than age four (4) and less than age twelve (12), and between 40 pounds (18 kilograms) and 80 pounds (36 kilograms) and upward to 100 pounds (45 kilograms) if recommended by your child restraint manufacturer). Many state and provincial laws require that children use approved booster seats until they reach age eight, a height of 4 feet 9 inches (1.45 meters) tall, or 80 pounds (36 kilograms).

Booster seats should be used until you can answer YES to ALL of these questions when seated without a booster seat:

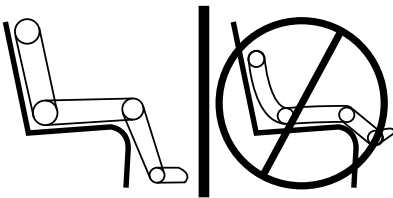

E142595

- Can the child sit all the way back against their vehicle seat back with knees bent comfortably at the edge of the seat cushion?
- Can the child sit without slouching?

- Does the lap belt rest low across the hips?
- Is the shoulder belt centered on the shoulder and chest?
- Can the child stay seated like this for the whole trip?

Always use booster seats in conjunction with your vehicle lap and shoulder belt.

### Types of Booster Seats



E68924

- Backless booster seats

If your backless booster seat has a removable shield, remove the shield. If a vehicle seating position has a low seat back or no head restraint, a backless booster seat may place your child's head (as measured at the tops of the ears) above the top of the seat. In this case, move the backless booster to another seating position with a higher seat back or head restraint and lap and shoulder belts, or consider using a high back booster seat.

# Child Safety



E70710

- High back booster seats

If, with a backless booster seat, you cannot find a seating position that adequately supports your child's head, a high back booster seat would be a better choice.

Children and booster seats vary in size and shape. Choose a booster that keeps the lap belt low and snug across the hips, never up across the stomach, and lets you adjust the shoulder belt to cross the chest and rest snugly near the center of the shoulder. The following drawings compare the ideal fit (center) to a shoulder belt uncomfortably close to the neck and a shoulder belt that could slip off the shoulder. The drawings also show how the lap belt should be low and snug across the child's hips.



E142596



E142597

# Child Safety

---

If the booster seat slides on the vehicle seat upon which it is being used, placing a rubberized mesh sold as shelf or carpet liner under the booster seat may improve this condition. Do not introduce any item thicker than this under the booster seat. Check with the booster seat manufacturer's instructions.

## Right-Hand Side

Turn clockwise to lock and counterclockwise to unlock.

## CHILD SAFETY LOCKS

### WARNING



You cannot open the rear doors from inside if you have put the child safety locks on.

---



E156821

## Left-Hand Side

Turn counterclockwise to lock and clockwise to unlock.

# Safety Belts

## PRINCIPLE OF OPERATION

### WARNINGS



Always drive and ride with your seat back upright and the lap belt snug and low across the hips.



To reduce the risk of injury, make sure children sit where they can be properly restrained.



Never let a passenger hold a child on his or her lap while your vehicle is moving. The passenger cannot protect the child from injury in a crash.



All occupants of your vehicle, including the driver, should always properly wear their safety belts, even when an airbag supplemental restraint system is provided. Failure to properly wear your safety belt could seriously increase the risk of injury or death.



It is extremely dangerous to ride in a cargo area, inside or outside of a vehicle. In a crash, people riding in these areas are more likely to be seriously injured or killed. Do not allow people to ride in any area of your vehicle that is not equipped with seats and safety belts. Be sure everyone in your vehicle is in a seat and using a safety belt properly.



In a rollover crash, an unbelted person is significantly more likely to die than a person wearing a safety belt.



Each seating position in your vehicle has a specific safety belt assembly which is made up of one buckle and one tongue that are designed to be used as a pair. 1) Use the shoulder belt on the outside shoulder only. Never wear the shoulder belt under the arm. 2) Never swing the safety belt around your neck over the inside shoulder. 3) Never use a single belt for more than one person.

### WARNINGS



When possible, all children 12 years old and under should be properly restrained in a rear seating position. Failure to follow this could seriously increase the risk of injury or death.



Safety belts and seats can become hot in a vehicle that has been closed up in sunny weather; they could burn a small child. Check seat covers and buckles before you place a child anywhere near them.



Front and rear seat occupants, including pregnant women, should wear safety belts for optimum protection in an accident.

All seating positions in your vehicle have lap and shoulder safety belts. All occupants of the vehicle should always properly wear their safety belts, even when an airbag supplemental restraint system is provided.

The safety belt system consists of:

- lap and shoulder safety belts.
- shoulder safety belt with automatic locking mode, (except driver safety belt).
- height adjuster at the front outboard seating positions.
- safety belt pretensioner at the front outboard seating positions.
- belt tension sensor at the front outboard passenger seating position.



- Safety belt warning light and chime.



# Safety Belts

- Crash sensors and monitoring system with readiness indicator.

The safety belt pretensioners at the front seating positions are designed to tighten the safety belts when activated. In frontal and near-frontal crashes, the safety belt pretensioners may be activated alone or, if the crash is of sufficient severity, together with the front airbags. The pretensioners may also activate when a side curtain airbag is deployed.

## FASTENING THE SAFETY BELTS

The front outboard and rear safety restraints in the vehicle are combination lap and shoulder belts.

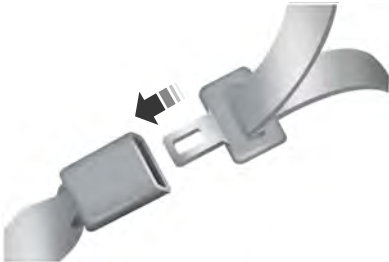

E142587

1. Insert the belt tongue into the proper buckle (the buckle closest to the direction the tongue is coming from) until you hear a snap and feel it latch. Make sure the tongue is securely fastened in the buckle.

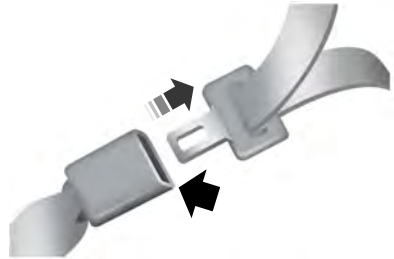

E142588

2. To unfasten, press the release button and remove the tongue from the buckle.



E142589

When in use, the rear safety belts should be placed in the belt guides on the outboard seat backs.

## Restraint of Pregnant Women

### WARNING



Always ride and drive with your seat back upright and the safety belt properly fastened. The lap portion of the safety belt should fit snug and be positioned low across the hips. The shoulder portion of the safety belt should be positioned across the chest. Pregnant women should also follow this practice. See the following figure.

# Safety Belts

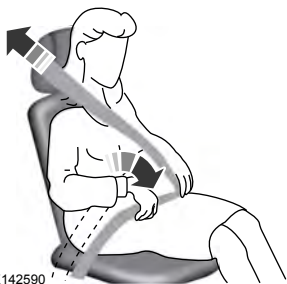

Pregnant women should always wear their safety belt. The lap belt portion of a combination lap and shoulder belt should be positioned low across the hips below the belly and worn as tight as comfort will allow. The shoulder belt should be positioned to cross the middle of the shoulder and the center of the chest.

## Safety Belt Locking Modes

### WARNINGS



After any vehicle crash, the safety belt system at all passenger seating positions must be checked by an authorized dealer to verify that the automatic locking retractor feature for child seats is still functioning properly. In addition, all safety belts should be checked for proper function.



Belt and retractor assembly must be replaced if the safety belt assembly automatic locking retractor feature or any other safety belt function is not operating properly when checked by an authorized dealer. Failure to replace the belt and retractor assembly could increase the risk of injury in crashes.

All safety restraints in the vehicle are combination lap and shoulder belts. The driver safety belt has the first type of locking mode, and the front outboard passenger and rear seat safety belts have both types of locking modes described as follows:

### Vehicle Sensitive Mode

This is the normal retractor mode, which allows free shoulder belt length adjustment to your movements and locking in response to vehicle movement. For example, if the driver brakes suddenly or turns a corner sharply, or the vehicle receives an impact of approximately 5 mph (8 km/h) or more, the combination safety belts will lock to help reduce forward movement of the driver and passengers.

In addition, the retractor is designed to lock if the webbing is pulled out too quickly. If this occurs, let the belt retract slightly and pull webbing out again in a slow and controlled manner.

### Automatic Locking Mode

In this mode, the shoulder belt is automatically pre-locked. The belt will still retract to remove any slack in the shoulder belt. The automatic locking mode is not available on the driver safety belt.

### When to Use the Automatic Locking Mode

This mode should be used any time a child safety seat, except a booster, is installed in passenger front or rear seating positions. Children 12 years old and under should be properly restrained in a rear seating position whenever possible. See **Child Safety** (page 14).

# Safety Belts

## How to Use the Automatic Locking Mode



E142591

1. Buckle the combination lap and shoulder belt.
2. Grasp the shoulder portion and pull downward until the entire belt is pulled out.

Allow the belt to retract. As the belt retracts, you will hear a clicking sound. This indicates the safety belt is now in the automatic locking mode.

## How to Disengage the Automatic Locking Mode

Unbuckle the combination lap and shoulder belt and allow it to retract completely to disengage the automatic locking mode and activate the vehicle sensitive (emergency) locking mode.

## Safety Belt Extension Assembly

### WARNING



Do not use extensions to change the fit of the shoulder belt across the torso.

If the safety belt is too short when fully extended, a safety belt extension assembly can be obtained from an authorized dealer.

Use only extensions manufactured by the same supplier as the safety belt. Manufacturer identification is located at the end of the webbing on the label. Also, use the safety belt extension only if the safety belt is too short for you when fully extended.

## SAFETY BELT HEIGHT ADJUSTMENT

### WARNING



Position the safety belt height adjuster so that the belt rests across the middle of your shoulder. Failure to adjust the safety belt properly could reduce the effectiveness of the safety belt and increase the risk of injury in a crash.

Adjust the height of the shoulder belt so the belt rests across the middle of your shoulder.

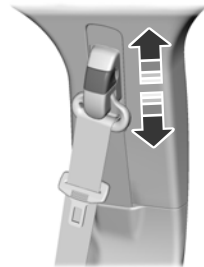

E145664

To adjust the shoulder belt height:

1. Pull the button and slide the height adjuster up or down.
2. Release the button and pull down on the height adjuster to make sure it is locked in place.



# Safety Belts

## SAFETY BELT WARNING LAMP AND INDICATOR CHIME (IF

EQUIPPED)



This lamp illuminates and an audible warning will sound if the driver's safety belt has not been fastened when the vehicle's ignition is turned on.

### Conditions of operation

If...	Then...
The driver's safety belt is not buckled before the ignition switch is turned to the on position...	The safety belt warning light illuminates 1-2 minutes and the warning chime sounds 4-8 seconds.
The driver's safety belt is buckled while the indicator light is illuminated and the warning chime is sounding...	The safety belt warning light and warning chime turn off.
The driver's safety belt is buckled before the ignition switch is turned to the on position...	The safety belt warning light and indicator chime remain off.

## SAFETY BELT MINDER (IF

EQUIPPED)

### Belt-Minder®

This feature supplements the safety belt warning function by providing additional reminders by intermittently sounding a chime and illuminating the safety belt warning light when the driver's or front passenger's seat is occupied and the safety belt is unbuckled.

The system uses information from the front passenger sensing system to determine if a front seat passenger is present and therefore potentially in need of a warning. To avoid activating the Belt-Minder feature for objects placed in the front passenger seat, warnings will only be given to front seat occupants as determined by the front passenger sensing system.

If the Belt-Minder warnings have expired (warnings for about five minutes) for one occupant (driver or front passenger), the other occupant can still activate the Belt-Minder feature.

# Safety Belts

If...	Then...
The driver's and front passenger's safety belts are buckled before the ignition switch is turned to the on position or less than 1-2 minutes have elapsed since the ignition switch has been turned to on...	The Belt-Minder feature will not activate.
The driver's or front passenger's safety belt is not buckled when the vehicle has reached at least 6 mph (9.7 km/h) and 1-2 minutes have elapsed since the ignition switch has been turned to on...	The Belt-Minder feature is activated - the safety belt warning light illuminates and the warning chime sounds for six seconds every 25 seconds, repeating for about five minutes or until the safety belts are buckled.
The driver's or front passenger's safety belt becomes unbuckled for about one minute while the vehicle is traveling at least 6 mph (9.7 km/h) and more than 1-2 minutes have elapsed since the ignition switch has been turned to on...	The Belt-Minder feature is activated - the safety belt warning light illuminates and the warning chime sounds for six seconds every 25 seconds, repeating for about five minutes or until the safety belts are buckled.

## Deactivating and Activating the Belt-Minder Feature

### WARNING



While the system allows you to deactivate it, this system is designed to improve your chances of being safely belted and surviving an accident. We recommend you leave the system activated for yourself and others who may use the vehicle. To reduce the risk of injury, do not deactivate or activate the system while driving the vehicle.

**Note:** *The driver and front passenger warning are deactivated and activated independently. When deactivating or activating one seating position, do not buckle the other position as this will terminate the process.*

Read Steps 1 - 4 thoroughly before proceeding with the programming procedure.

The system can be deactivated or activated by performing the following procedure:

Before following the procedure, make sure that:

- the parking brake is set
- the transmission selector lever is in position **P** (automatic transmission) or **N** (manual transmission)
- the ignition is off
- the driver and front passenger safety belts are unbuckled.

1. Turn the ignition on. Do not start the vehicle.
2. Wait until the safety belt warning light turns off (about one minute). After Step 2, wait an additional five seconds before proceeding with Step 3. Once Step 3 is started, the procedure must be completed within 30 seconds.

# Safety Belts

---

3. For the seating position being disabled, buckle then unbuckle the safety belt three times at a moderate speed, ending in the unbuckled state. After Step 3, the safety belt warning light will turn on.
4. While the safety belt warning light is on, buckle and then unbuckle the safety belt. After Step 4, the safety belt warning light will flash for confirmation.
  - This will disable the feature for that seating position if it is currently enabled.
  - This will enable the feature for that seating position if it is currently disabled.

Ford Motor Company recommends that all safety belt assemblies in use in vehicles involved in a crash be replaced. However, if the crash was minor and an authorized dealer finds that the belts do not show damage and continue to operate properly, they do not need to be replaced. Safety belt assemblies not in use during a crash should also be inspected and replaced if either damage or improper operation is noted.

Properly care for safety belts.

## CHILD RESTRAINT AND SAFETY BELT MAINTENANCE

Inspect the vehicle safety belts and child safety seat systems periodically to make sure they work properly and are not damaged. Inspect the vehicle and child seat safety belts to make sure there are no nicks, tears or cuts. Replace if necessary. All vehicle safety belt assemblies, including retractors, buckles, front safety belt buckle assemblies, buckle support assemblies (slide bar-if equipped), shoulder belt height adjusters (if equipped), shoulder belt guide on seat back (if equipped), child safety seat LATCH and tether anchors, and attaching hardware, should be inspected after a crash. Read the child restraint manufacturer's instructions for additional inspection and maintenance information specific to the child restraint.

# Personal Safety System™

---

The Personal Safety System provides an improved overall level of frontal crash protection to front seat occupants and is designed to help further reduce the risk of airbag-related injuries. The system is able to analyze different occupant conditions and crash severity before activating the appropriate safety devices to help better protect a range of occupants in a variety of frontal crash situations.

Your vehicle's Personal Safety System consists of:

- Driver and passenger dual-stage airbag supplemental restraints.
- Front outboard safety belts with pretensioners, energy management retractors (first row only), and safety belt usage sensors.
- Driver's seat position sensor.
- Front passenger sensing system.
- Passenger airbag off and on indicator lamp.
- Front crash severity sensors.
- Restraints control module with impact and safing sensors.
- Restraint system warning light and backup tone.
- The electrical wiring for the airbags, crash sensor(s), safety belt pretensioners, front safety belt usage sensors, driver seat position sensor, front passenger sensing system, and indicator lights.

module. During a crash, the restraints control module may activate the safety belt pretensioners and may activate either one or both stages of the dual-stage airbag supplemental restraints based on crash severity and occupant conditions.

## How Does the Personal Safety System Work?

The Personal Safety System can adapt the deployment strategy of your vehicle's safety devices according to crash severity and occupant conditions. A collection of crash and occupant sensors provides information to the restraints control

# Supplementary Restraints System

---

## PRINCIPLE OF OPERATION

### WARNINGS

 Airbags do not inflate slowly or gently, and the risk of injury from a deploying airbag is the greatest close to the trim covering the airbag module.

 All occupants of your vehicle, including the driver, should always properly wear their safety belts, even when an airbag supplemental restraint system is provided. Failure to properly wear your safety belt could seriously increase the risk of injury or death.

 Always transport children 12 years old and under in the back seat and always properly use appropriate child restraints. Failure to follow this could seriously increase the risk of injury or death.

 Never place your arm over the airbag module as a deploying airbag can result in serious arm fractures or other injuries.

 Airbags can kill or injure a child in a child seat. Never place a rear-facing child seat in front of an active airbag. If you must use a forward-facing child seat in the front seat, move the seat upon which the child seat is installed all the way back.

 Do not attempt to service, repair, or modify the airbag supplemental restraint systems or its fuses as you could be seriously injured or killed. Contact your authorized dealer as soon as possible.

 Several airbag system components get hot after inflation. Do not touch them after inflation as this may result in serious injury.

 If the airbag has deployed, the airbag will not function again and must be replaced immediately. If the airbag is not replaced, the unrepaired area will increase the risk of injury in a collision.

The airbags are a supplemental restraint system and are designed to work with the safety belts to help protect the driver and right front passenger from certain upper body injuries. Airbags do not inflate slowly; there is a risk of injury from a deploying airbag.

**Note:** *You will hear a loud bang and see a cloud of harmless powdery residue if an airbag deploys. This is normal.*

The airbags inflate and deflate rapidly upon activation. After airbag deployment, it is normal to notice a smoke-like, powdery residue or smell the burnt propellant. This may consist of cornstarch, talcum powder (to lubricate the bag) or sodium compounds (for example, baking soda) that result from the combustion process that inflates the airbag. Small amounts of sodium hydroxide may be present which may irritate the skin and eyes, but none of the residue is toxic.

While the system is designed to help reduce serious injuries, contact with a deploying airbag may also cause abrasions or swelling. Temporary hearing loss is also a possibility as a result of the noise associated with a deploying airbag. Because airbags must inflate rapidly and with considerable force, there is the risk of death or serious injuries such as fractures, facial and eye injuries or internal injuries, particularly to occupants who are not properly restrained or are otherwise out of position at the time of airbag deployment. Thus, it is extremely important that occupants be properly restrained as far away from the airbag module as possible while maintaining vehicle control.

Routine maintenance of the airbags is not required.

# Supplementary Restraints System

## DRIVER AND PASSENGER AIRBAGS

### WARNINGS



Never place your arm or any objects over an airbag module. Placing your arm over a deploying airbag can result in serious arm fractures or other injuries. Objects placed on or over the airbag inflation area may cause those objects to be propelled by the airbag into your face and torso causing serious injury.



Airbags can kill or injure a child in a child seat. Never place a rear-facing child seat in front of an active airbag. If you must use a forward-facing child seat in the front seat, move the seat upon which the child seat is installed all the way back.

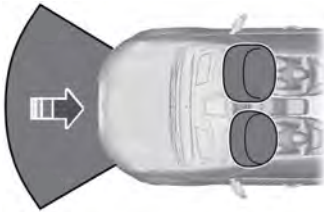

E151127

The driver and front passenger airbags will deploy during significant frontal and near frontal crashes.

The driver and passenger front airbag system consists of:

- driver and passenger airbag modules.
- front passenger sensing system.



• crash sensors and monitoring system with readiness indicator. See **Crash Sensors and Airbag**

**Indicator** (page 41).

## Proper Driver and Front Passenger Seating Adjustment

### WARNING



National Highway Traffic Safety Administration (NHTSA) recommends a minimum distance of at least 10 inches (25 centimeters) between an occupant's chest and the driver airbag module.

To properly position yourself away from the airbag:

- Move your seat to the rear as far as you can while still reaching the pedals comfortably.
- Recline the seat slightly (one or two degrees) from the upright position.

After all occupants have adjusted their seats and put on safety belts, it is very important that they continue to sit properly. A properly seated occupant sits upright, leaning against the seat back, and centered on the seat cushion, with their feet comfortably extended on the floor. Sitting improperly can increase the chance of injury in a crash event. For example, if an occupant slouches, lies down, turns sideways, sits forward, leans forward or sideways, or puts one or both feet up, the chance of injury during a crash is greatly increased.

## Children and Airbags

### WARNING



Airbags can kill or injure a child in a child seat. Never place a rear-facing child seat in front of an active airbag. If you must use a forward-facing child seat in the front seat, move the seat upon which the child seat is installed all the way back.

# Supplementary Restraints System



E142846

Children must always be properly restrained. Accident statistics suggest that children are safer when properly restrained in the rear seating positions than in the front seating position. Failure to follow these instructions may increase the risk of injury in a crash.

## FRONT PASSENGER SENSING SYSTEM

### WARNINGS



Even with Advanced Restraints Systems, children 12 and under should be properly restrained in a rear seating position. Failure to follow this could seriously increase the risk of injury or death.



Sitting improperly out of position or with the seat back reclined too far can take off weight from the seat cushion and affect the decision of the front passenger sensing system, resulting in serious injury or death in a crash.



To reduce the risk of possible serious injury: Do not stow objects in seat back map pocket or hang objects off seat back if a child is in the front passenger seat. Do not place objects underneath the front passenger seat or between the seat

### WARNINGS

and the center console. Check the passenger airbag off or pass airbag off indicator lamp for proper airbag status. Failure to follow these instructions may interfere with the front passenger seat sensing system.



Any alteration or modification to the front passenger seat may affect the performance of the front passenger sensing system.

This system works with sensors that are part of the front passenger's seat and safety belt to detect the presence of a properly-seated occupant and determine if the front passenger's frontal airbag should be enabled (may inflate) or not.

PASS AIRBAG OFF

E157152

The front passenger sensing system uses a pass airbag off indicator which will illuminate and stay lit to remind you that the front passenger frontal airbag is disabled.

The indicator lamp is located at the top center of the instrument panel.

**Note:** *When the ignition is first tuned on, the indicator lamp will illuminate for a short period of time to confirm it is functional.*

The front passenger sensing system is designed to disable (will not inflate) the front passenger's frontal airbag when a rear facing infant seat, a forward-facing child restraint, or a booster seat is detected. Even with this technology,

# Supplementary Restraints System

parents are **STRONGLY** encouraged to always properly restrain children in the rear seat. The sensor also turns off the passenger front airbag and seat-mounted side airbag when the passenger seat is empty.

- When the front passenger sensing system disables (will not inflate) the front passenger frontal airbag, the indicator lamp will illuminate and stay lit to remind you that the front passenger frontal airbag is disabled.
- If the child restraint has been installed and the indicator lamp is not lit, then turn the vehicle off, remove the child restraint from the vehicle and reinstall the restraint following the child restraint manufacturer's instructions.

The front passenger sensing system is designed to enable (may inflate) the front passenger's frontal airbag anytime the system senses that a person of adult size is sitting properly in the front passenger seat.

- When the front passenger sensing system enables the front passenger frontal airbag (may inflate), the indicator lamp will be unlit and stay unlit.

If a person of adult size is sitting in the front passenger's seat, but the airbag off indicator lamp is lit, it is possible that the person isn't sitting properly in the seat. If this happens:

- Turn the vehicle off and ask the person to place the seat back in the full upright position.
- Have the person sit upright in the seat, centered on the seat cushion, with the person's legs comfortably extended.
- Restart the vehicle and have the person remain in this position for about two minutes. This will allow the system to detect that person and enable the passenger's frontal airbag.
- If the indicator lamp remains lit even after this, the person should be advised to ride in the rear seat.

Occupant	Passenger airbag OFF indicator	Passenger airbag
Empty	Unlit	Disabled
Child	Lit	Disabled
Adult	Unlit	Enabled

**Note:** *When the passenger airbag off light is illuminated, the passenger (seat mounted) side airbag may be disabled to avoid the risk of airbag deployment injuries.*

After all occupants have adjusted their seats and put on safety belts, it is very important that they continue to sit properly. A properly seated occupant sits upright, leaning against the seat back, and centered on the seat cushion, with their feet comfortably extended on the floor. Sitting improperly can increase the chance

of injury in a crash event. For example, if an occupant slouches, lies down, turns sideways, sits forward, leans forward or sideways, or puts one or both feet up, the chance of injury during a crash is greatly increased.

If you think that the status of the passenger airbag off indicator lamp is incorrect, check for the following:



# Supplementary Restraints System

- Objects lodged underneath the seat
- Objects between the seat cushion and the center console
- Objects hanging off the seat back
- Objects stowed in the seat back map pocket
- Objects placed on the occupant's lap
- Cargo interference with the seat
- Other passengers pushing or pulling on the seat
- Rear passenger feet and knees resting or pushing on the seat

The conditions listed above may cause the weight of a properly seated occupant to be incorrectly interpreted by the front passenger sensing system. The person in the front passenger seat may appear heavier or lighter due to the conditions described in the list above.



Make sure the front passenger sensing system is operating properly. See **Crash Sensors and Airbag Indicator** (page 41).

## If the airbag readiness light is lit, do the following:

The driver and adult passengers should check for objects lodged underneath the front passenger seat, or cargo interfering with the seat.

If there are lodged objects, or cargo is interfering with the seat, take the following steps to remove the obstruction:

- Pull the vehicle over.
- Turn the vehicle off.
- Driver and adult passengers should check for any objects lodged underneath the front passenger seat or cargo interfering with the seat.
- Remove the obstruction(s) (if found).
- Restart the vehicle.

- Wait at least two minutes and verify that the airbag readiness light is no longer illuminated.
- If the airbag readiness light remains illuminated, this may or may not be a problem due to the front passenger sensing system.

Do not attempt to repair or service the system. Take your vehicle immediately to an authorized dealer.

If it is necessary to modify an advanced front airbag system to accommodate a person with disabilities, contact the Ford Customer Relationship Center. See **Getting the Services You Need** (page 160).

## SIDE AIRBAGS

### WARNINGS



Do not place objects or mount equipment on or near the airbag cover, on the side of the seatbacks (of the front seats), or in front seat areas that may come into contact with a deploying airbag. Failure to follow these instructions may increase the risk of personal injury in the event of a crash.



Do not use accessory seat covers. The use of accessory seat covers may prevent the deployment of the side airbags and increase the risk of injury in an accident.



Do not lean your head on the door. The side airbag could injure you as it deploys from the side of the seatback.



Do not attempt to service, repair, or modify the airbag, its fuses or the seat cover on a seat containing an airbag as you could be seriously injured or killed. Contact your authorized dealer as soon as possible.

# Supplementary Restraints System

## WARNINGS



If the side airbag has deployed, the airbag will not function again. The side airbag system (including the seat) must be inspected and serviced by an authorized dealer. If the airbag is not replaced, the unrepaired area will increase the risk of injury in a crash.

The side airbags are located on the outboard side of the seatbacks of the front seats. In certain sideways crashes, the airbag on the side affected by the crash will be inflated. The airbag was designed to inflate between the door panel and occupant to further enhance the protection provided occupants in side impact crashes.



E152533

The system consists of the following:

- A label or embossed side panel indicating that side airbags are fitted to your vehicle.
- Side airbags located inside the driver and front passenger seatbacks.
- Front passenger sensing system.



• Crash sensors and monitoring system with readiness indicator. See **Crash Sensors and Airbag Indicator** (page 41).

**Note:** *The passenger sensing system will deactivate the passenger seat-mounted side airbag if it detects an empty passenger seat.*

The design and development of the side airbag system included recommended testing procedures that were developed by a group of automotive safety experts known as the Side Airbag Technical Working Group. These recommended testing procedures help reduce the risk of injuries related to the deployment of side airbags.

## KNEE AIRBAG (IF EQUIPPED)

A driver's knee airbag is located under or within the instrument panel. During a crash, the restraints control module may activate the driver's knee airbag based on crash severity and occupant conditions. Under certain crash and occupant conditions, the driver's knee airbag may deploy but the driver's front airbag may not activate. As with front and side airbags, it is important to be properly seated and restrained to reduce the risk of death or serious injury.



Make sure the knee airbag is operating properly. See **Crash Sensors and Airbag Indicator** (page 41).

## SIDE CURTAIN AIRBAGS

### WARNINGS



Do not place objects or mount equipment on or near the headliner at the siderail that may come into contact with a deploying side curtain airbag. Failure to follow these instructions may increase the risk of personal injury in the event of a crash.



Do not lean your head on the door. The side curtain airbag could injure you as it deploys from the headliner.

# Supplementary Restraints System

## WARNINGS



Do not attempt to service, repair, or modify the side curtain airbags, its fuses, the A, B, or C pillar trim, or the headliner on a vehicle containing side curtain airbags. Contact your authorized dealer as soon as possible.



All occupants of the vehicle including the driver should always wear their safety belts even when an airbag supplemental restraint system and side curtain airbag is provided.



To reduce risk of injury, do not obstruct or place objects in the deployment path of the side curtain airbag.



If the side curtain airbags have deployed, the side curtain airbags will not function again. The side curtain airbags (including the A, B and C pillar trim and headliner) must be inspected and serviced by an authorized dealer. If the side curtain airbag is not replaced, the unrepaired area will increase the risk of injury in a crash.

The side curtain airbags will deploy during significant side crashes. The side curtain airbags are mounted to the roof side-rail sheet metal, behind the headliner, above each row of seats. The side curtain airbags are designed to inflate between the side window area and occupants to further enhance protection provided in side impact crashes.

The system consists of the following:

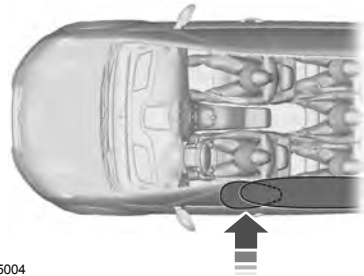

E75004

- Side curtain airbags located above the trim panels over the front and rear side windows identified by a label or wording on the headliner or roof-pillar trim.
- A flexible headliner which opens above the side doors to allow side air curtain deployment.



Crash sensors and monitoring system with readiness indicator. See **Crash Sensors and Airbag Indicator** (page 41).

Children 12 years old and under should always be properly restrained in the back seats. The side curtain airbags will not interfere with children restrained using a properly installed child or booster seat because it is designed to inflate downward from the headliner above the doors along the side window opening.

The design and development of the side curtain airbags included recommended testing procedures that were developed by a group of automotive safety experts known as the Side Airbag Technical Working Group. These recommended testing procedures help reduce the risk of injuries related to the deployment of side curtain airbags.

# Supplementary Restraints System

## CRASH SENSORS AND AIRBAG INDICATOR

### WARNING



Modifying or adding equipment to the front end of the vehicle (including frame, bumper, front end body structure and tow hooks) may affect the performance of the airbag system, increasing the risk of injury. Do not modify the front end of the vehicle.

The vehicle has a collection of crash and occupant sensors which provide information to the restraints control module which deploys (activates) the front safety belt pretensioners, driver airbag, passenger airbag, knee airbag(s), seat mounted side airbags, and the side curtain airbags. Based on the type of crash (frontal impact or side impact), the restraints control module will deploy the appropriate safety devices.

The restraints control module also monitors the readiness of the above safety devices plus the crash and occupant sensors. The readiness of the safety system is indicated by a warning indicator light in the instrument cluster or by a backup tone if the warning light is not working. Routine maintenance of the airbag is not required.

A difficulty with the system is indicated by one or more of the following:



The readiness light will not illuminate immediately after the ignition is turned on.

- The readiness light will either flash or stay lit.
- A series of five beeps will be heard. The tone pattern will repeat periodically until the problem, the light or both are repaired.

If any of these things happen, even intermittently, have the supplemental restraint system serviced at an authorized dealer immediately. Unless serviced, the system may not function properly in the event of a crash.

The safety belt pretensioners and the front airbag supplemental restraint system are designed to activate when the vehicle sustains longitudinal deceleration sufficient to cause the restraints control module to deploy a safety device.

The fact that the safety belt pretensioners or front airbags did not activate for both front seat occupants in a crash does not mean that something is wrong with the system. Rather, it means the restraints control module determined the accident conditions (crash severity, belt usage) were not appropriate to activate these safety devices.

- The design of the front airbags is to activate only in frontal and near-frontal crashes (not rollovers, side impacts or rear impacts) unless the crash causes sufficient longitudinal deceleration.
- The design of the safety belt pretensioners is to activate in frontal and near-frontal crashes, and may also activate when a side curtain deploys.
- The driver's knee airbag may deploy based on crash severity and occupant conditions.

# Supplementary Restraints System

---

- The design of the side airbags is to inflate in certain side impact crashes. Side airbags may activate in other types of crashes if your vehicle experiences sufficient sideways motion or deformation.
- The design of the Safety Canopy is to inflate in certain side impact crashes or rollover events. The Safety Canopy may activate in other types of crashes if your vehicle experiences sufficient sideways motion or deformation, or a certain likelihood of rollover.

## **AIRBAG DISPOSAL**

Contact your authorized dealer as soon as possible. Airbags must be disposed of by qualified personnel.

# Keys and Remote Controls

## GENERAL INFORMATION ON RADIO FREQUENCIES

This device complies with Part 15 of the FCC Rules and with Industry Canada license-exempt RSS standard(s). Operation is subject to the following two conditions: (1) This device may not cause harmful interference, and (2) This device must accept any interference received, including interference that may cause undesired operation.

**Note:** *Changes or modifications not expressly approved by the party responsible for compliance could void the user's authority to operate the equipment. The term IC before the radio certification number only signifies that Industry Canada technical specifications were met.*

The typical operating range for your transmitter is approximately 33 feet (10 meters). Vehicles with the remote start feature will have a greater range. One of the following could cause a decrease in operating range:

- weather conditions
- nearby radio towers
- structures around the vehicle
- other vehicles parked next to your vehicle

The radio frequency used by your remote control can also be used by other short distance radio transmissions, for example amateur radios, medical equipment, wireless headphones, remote controls and alarm systems. If the frequencies are jammed, you will not be able to use your remote control. You can lock and unlock the doors with the key.

**Note:** *Make sure to lock your vehicle before leaving it unattended.*

**Note:** *If you are in range, the remote control will operate if you press any button unintentionally.*

## Intelligent Access (If Equipped)

The system uses a radio frequency signal to communicate with your vehicle and authorize your vehicle to unlock when one of the following conditions are met:

- You touch the inside of the front exterior door handle.
- You press the luggage compartment button.
- You press a button on the transmitter.

If excessive radio frequency interference is present in the area or if the transmitter battery is low, you may need to mechanically unlock your door. You can use the mechanical key blade in your intelligent access key to open the driver door in this situation. See **Remote Control** (page 43).

## REMOTE CONTROL

### Integrated Keyhead Transmitter (If Equipped)

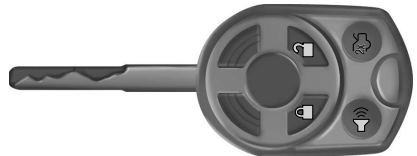

E142585

Use the key blade to start your vehicle and unlock or lock the driver door from outside your vehicle. The transmitter portion functions as the remote control.

# Keys and Remote Controls



E162601

**Note:** Your vehicle's keys came with a security label that provides important vehicle key cut information. Keep the label in a safe place for future reference.

## Intelligent Access Transmitter (if Equipped)

Your intelligent access keys operate the power locks. The key must be in your vehicle to activate the push button start system.

The intelligent access key also contains a removable mechanical key blade that you can use to unlock the driver door.



E87964

**Note:** Your vehicle's back-up keys came with a security tag that provides important vehicle key cut information. Keep the tag in a safe place for future reference.

## Reprogramming the Unlocking Function

**Note:** When you press the unlock button either all the doors are unlocked or only the driver's door and the liftgate are unlocked. Pressing the unlock button again unlocks all the doors.

You can reprogram the unlocking function using the remote control so that only the driver's door is unlocked. This will enable two-stage unlocking.

Press and hold the unlock and lock buttons on the remote control simultaneously for at least four seconds with the ignition off. The direction indicators will flash twice to confirm the change.

To return to the original unlocking function, repeat the process.

## Replacing the Battery

**Note:** Refer to local regulations when disposing of transmitter batteries.

**Note:** Do not wipe off any grease on the battery terminals or on the back surface of the circuit board.

**Note:** Replacing the battery will not delete the transmitter from the vehicle. The transmitter should operate normally.

The remote control uses one coin-type three-volt lithium battery CR2032 or equivalent.

# Keys and Remote Controls

## Vehicles Without Intelligent Access

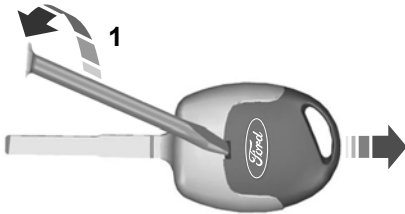

E126152

1. Insert a screwdriver into the recess on the back of the key and remove the key blade.

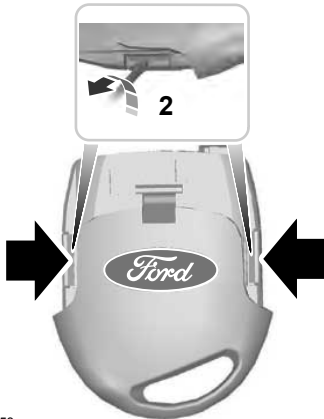

E126153

2. Release the retaining clips with the screwdriver and separate the two halves of the remote control.



E126281

**Note:** Do not touch the battery contacts or the printed circuit board with the screwdriver.

3. Carefully pry out the battery with the screwdriver.
4. Install a new battery (3V CR2032) with the + facing upward.
5. Assemble the two halves of the remote control.
6. Install the key blade.

## Integrated Keyhead Transmitter



E138619

1. Twist a thin coin in the slot of the transmitter near the key ring to remove the battery cover.
2. Remove the old battery.



# Keys and Remote Controls

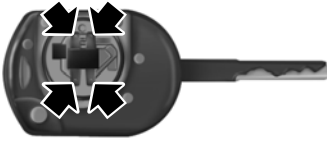

E138620

3. Insert the new battery. Refer to the instructions inside the transmitter for the correct orientation of the battery. Press the battery down to make sure it is fully in the housing.
4. Snap the battery cover back onto the transmitter.

## Intelligent Access Transmitter

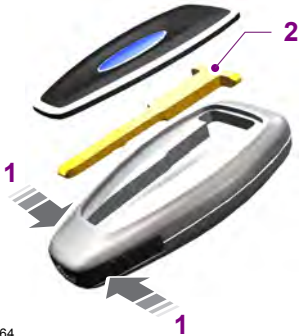

E87964

1. Press and hold the buttons on the edges to release the cover. Carefully remove the cover.
2. Remove the key blade.

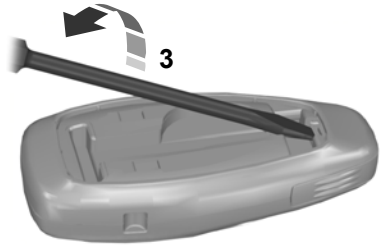

E105362

3. Twist the screwdriver in the position shown to start separating the two halves of the remote control.



E119190

4. Twist the screwdriver in the position shown to separate the two halves of the remote control.

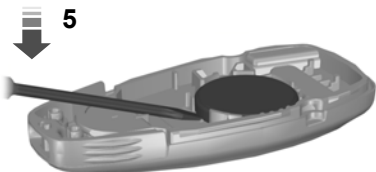

E125860

# Keys and Remote Controls

---

**Note:** Do not touch the battery contacts or the printed circuit board with the screwdriver.

5. Carefully remove the battery with the screwdriver.
6. Install a new battery (3V CR 2032) with the + facing downward.
7. Assemble the two halves of the remote control.
8. Install the key blade.

## Car Finder



Press the button twice within three seconds. The horn will sound and the turn signals will flash. We recommend you use this method to locate your vehicle, rather than using the panic alarm.

**Note:** If locking was not successful or if any door or the liftgate is open, or if the hood is open on vehicles with a perimeter alarm or remote start, the horn will sound twice and the lamps will not flash.

## Sounding a Panic Alarm (If Equipped)

**Note:** The panic alarm will only operate when the ignition is off.



Press the button to activate the alarm. Press the button again or turn the ignition on to deactivate.

## REPLACING A LOST KEY OR REMOTE CONTROL

Replacement or additional keys or remote controls can be purchased from an authorized dealer. Your dealer can program the remote controls for your vehicle or you may be able to program them yourself. See **Remote Control** (page 43).

To re-program the passive anti-theft system see an authorized dealer.

## PRINCIPLE OF OPERATION

MyKey allows you to program keys with restricted driving modes to promote good driving habits. All but one of the keys programmed to the vehicle can be activated with these restricted modes.

Any keys that have not been programmed are referred to as administrator keys or admin keys. These can be used to:

- Create a MyKey
- Program configurable MyKey settings
- Clear all MyKey features

When you have created a MyKey, you can access the following information using the information display:

- How many admin keys and MyKeys are programmed to your vehicle.
- The total distance your vehicle has traveled using any MyKey.

**Note:** All MyKeys are programmed to the same settings. You cannot program them individually.

If a MyKey and an admin key are present, your vehicle will recognize the admin key only.

**Note:** For vehicles with intelligent access key (push button start) keyless start, when both a MyKey and an admin intelligent access key (fob) are present, the admin fob will be recognized by the vehicle to start the engine.

## Non-configurable Settings

The following settings cannot be changed by an admin key user:

- Belt-minder. You cannot disable this feature. The audio system will mute when the safety belts are not fastened.
- Early low fuel warning. The low-fuel warning activates earlier, giving the MyKey user more time to refuel.

- Driver assist features, if equipped on your vehicle, are forced on: parking aid, blind spot information system (BLIS) with cross traffic alert, lane departure warning and forward collision warning system.
- Satellite radio adult content restrictions.

## Configurable Settings

With an admin key, you can configure certain MyKey settings when you first create a MyKey and before you recycle the key or restart the vehicle. You can also change the settings afterward with an admin key:

- Vehicle speed limits can be set. Warnings will be shown in the display followed by an audible tone when your vehicle reaches the set speed. You cannot override the set speed by fully depressing the accelerator pedal.
- Vehicle speed minders of 45, 55 or 65 mph (75, 90 or 105 km/h). Once you select a speed it will be shown in the display followed by an audible tone when the set vehicle speed is exceeded.
- Audio system maximum volume of 45%. A message will be shown in the display when you attempt to exceed the limited volume. Also, the speed sensitive compensated volume (automatic volume control) feature will be disabled.
- Always on setting. When this is selected you will not be able to disable AdvanceTrac, 911 Assist or the do not disturb feature (if your vehicle is equipped with these features).

## CREATING A MYKEY

Use the information display to create a MyKey.

1. Insert the key you want to program into the ignition or, if the vehicle has push button start, hold the intelligent access key or fob next to the steering column.
2. Using the information display controls, access the main menu and select **Settings**, then **MyKey** by pressing **OK** or the right arrow button.
3. Press **OK** to select **Create MyKey**.
4. When prompted, hold the **OK** button until you see a message informing you to label this key as a MyKey. The key will be restricted at the next start.

MyKey is successfully created. Make sure you label it so you can distinguish it from the admin keys.

You can program configurable settings for the key(s). Refer to **Programming or Changing Configurable Settings**.

### Programming or Changing Configurable Settings

Use the information display to access your configurable MyKey settings.

1. Switch the ignition on using an admin key. If the vehicle has push-button start, hold an intelligent access admin key or fob next to the steering column and use the push-button start to switch the ignition on.
2. Access the main menu and select **Settings**, then **MyKey** by pressing **OK** or the right arrow key.
3. Use the arrow buttons to get to a configurable feature.
4. Press **OK** or the right arrow button to make a selection.

**Note:** *You can clear or change your MyKey settings at any time during the same key cycle as you created the MyKey. If you switch the ignition off, however, you will need to use an admin key to clear your MyKeys.*

### CLEARING ALL MYKEYS

You can clear all MyKeys within the same key cycle as you created the MyKey. If you switch your ignition off, however, you will need to use an admin key to clear your MyKeys.

**Note:** *When you clear your MyKeys, you remove all restrictions and return all MyKeys to their original admin key status at once.*

To clear all MyKeys of all MyKey settings, use the information display to do the following:

1. Access the main menu and select **Settings**, then **MyKey**.
2. Scroll to **Clear MyKey** and press the **OK** button.
3. Hold the **OK** button until **ALL MYKEYS CLEARED** displays.

### CHECKING MYKEY SYSTEM STATUS

You can find information about your programmed MyKeys by using the information display.

#### MyKey Distance

Tracks the distance when drivers use a MyKey. The only way to delete the accumulated distance is by using an admin key to clear your MyKey. If the distance does not accumulate as expected, then the intended user is not using the MyKey, or an admin key user recently cleared and then recreated a MyKey.

#### Number of MyKeys

Indicates the number of MyKeys programmed to your vehicle. Use this feature to detect how many MyKeys you have for your vehicle and determine when a MyKey has been deleted.

## Number of Admin Keys

Indicates how many admin keys are programmed to your vehicle. Use this feature to determine how many admin keys you have for your vehicle, and detect if an additional MyKey has been programmed.

## USING MYKEY WITH REMOTE START SYSTEMS

MyKey is not compatible with non-Ford-approved aftermarket remote start systems. If you choose to install a remote start system, please see an authorized dealer for a Ford-approved remote start system.

## MYKEY TROUBLESHOOTING

Condition	Potential causes
I cannot create a MyKey.	<ul style="list-style-type: none"> <li>· The key or fob used to start the vehicle does not have admin privileges.</li> <li>· The key or fob used to start the vehicle is the only admin key (there always has to be at least one admin key).</li> <li>· Vehicles with push-button start: The intelligent access key is not in the correct position. The position location is in another chapter. See <b>Keyless Starting</b> (page 113).</li> <li>· SecuriLock passive anti-theft system is disabled or in unlimited mode.</li> </ul>
I cannot program the configurable settings.	<ul style="list-style-type: none"> <li>· The key or fob used to start the vehicle does not have admin privileges.</li> <li>· No MyKeys have been created. See <b>Creating a MyKey</b> (page 48).</li> </ul>
I cannot clear the MyKeys.	<ul style="list-style-type: none"> <li>· The key or fob used to start the vehicle does not have admin privileges.</li> <li>· No MyKeys are programmed to the vehicle. See <b>Creating a MyKey</b> (page 48).</li> </ul>
I lost the only admin key.	Purchase a new key from an authorized dealer.
I lost a key.	Program a spare key. See <b>Passive Anti-Theft System</b> (page 60).
No MyKey functions with intelligent access key (push-button start).	<ul style="list-style-type: none"> <li>· An admin key is present at engine start-up.</li> <li>· No MyKeys are programmed to the vehicle. See <b>Creating a MyKey</b> (page 48).</li> </ul>
MyKey distances do not accumulate.	· The MyKey user is not using a MyKey.

# MyKey™ (If Equipped)

---

<b>Condition</b>	<b>Potential causes</b>
	· An admin key holder cleared the MyKeys and reset the key system.

# Locks

## LOCKING AND UNLOCKING

### Remote Control

The remote control can be used any time your vehicle is not running.

#### Unlocking the Doors

**Note:** You can unlock the driver's door with the key. Use the key when the remote control is not functioning.

**Note:** When you lock your vehicle for several weeks, the remote control will be switched off. Your vehicle must be unlocked and the engine started using the key. Unlocking and starting your vehicle once will enable the remote control.

#### One-Stage Unlocking



Press the button to unlock all the doors.

The direction indicators will flash.

#### Two-Stage Unlocking



Press the button to unlock the driver's door.

Press the button again within three seconds to unlock all doors.

The direction indicators will flash.

#### Reprogramming the Unlocking Function

You can reprogram the unlocking function using the remote control to change between one-stage and two-stage unlocking. See **Remote Control** (page 43).

#### Locking the Doors



Press the button to lock all the doors. The direction indicators will flash twice.

Press the button again within three seconds to confirm that all the doors are closed. The doors will lock again, and the direction indicators will flash twice if all the doors and the luggage compartment are closed.

**Note:** If any door or the luggage compartment is not closed, or if the hood is not closed on vehicles that have an anti-theft alarm or remote start, the direction indicators will not flash.

#### Automatic Re-locking

The doors will relock automatically if you do not open a door within 45 seconds of unlocking the doors with the remote control. The door locks and the alarm will return to their previous state.

#### Locking and Unlocking the Doors From Inside

The power door lock control is located on the instrument panel near the radio.



Press the button to lock and unlock all the doors. The lamp illuminates with the doors locked.

#### Locking and Unlocking the Doors With the Key

**Note:** Do not leave your keys in your vehicle.

#### Locking With the Key

Turn the top of the key toward the front of your vehicle.

#### Unlocking With the Key

Turn the top of the key toward the rear of your vehicle.

# Locks

## Unlocking the Doors With the Interior Door Handles

You can unlock individual doors by pulling the relevant interior door handle. Pulling the driver's interior door handle will unlock all the doors, if auto unlock has been enabled.

## Rear Door Unlocking and Opening

Pull the interior door release handle twice to unlock and open the rear door. The first pull unlocks the door and the second pull will unlatch the door.

## Smart Unlocks for Integrated Keyhead Transmitter

This feature helps to prevent you from locking yourself out of your vehicle if your key is still in the ignition.

When you open one of the front doors and lock your vehicle with the power door lock control, all the doors will lock then unlock if your key is still in the ignition.

You can still lock your vehicle with the key in the ignition by pressing the lock button on the transmitter even if the doors are not closed.

If both front doors are closed, you can lock your vehicle by any method, regardless of whether the key is in the ignition or not.

## Smart Unlocks for Intelligent Access Keys (If Equipped)

This feature helps to prevent you from unintentionally locking your intelligent access key inside your vehicle's passenger compartment or rear cargo area.

When you lock your vehicle using the power door lock control (with the door open, vehicle in park and ignition off), your vehicle will search for an intelligent access key in the passenger compartment after you close the door. If your vehicle finds a key, all of the doors will immediately unlock and the horn will chirp, indicating that a key is inside.

In order to override the smart unlock feature and intentionally lock the intelligent access key inside your vehicle, you can lock your vehicle after all doors are closed by pressing the lock button on another intelligent access key or touching the locking area on the handle with another intelligent access key in your hand.

When you open one of the front doors and lock your vehicle using the power door lock control, all doors will lock then unlock if:

- the ignition is on, or
- the ignition is off and the transmission is not in **P**.

## Auto Lock Feature

The auto lock feature will lock the doors and liftgate when all of the following conditions have been met:

- All doors are closed.
- The ignition is on.
- Your vehicle is moving at a speed greater than 12 mph (20 km/h) for more than two seconds.

## Enabling or Disabling Auto Lock

**Note:** You cannot disable the auto lock feature in some markets.

**Note:** See an authorized dealer to enable or disable the auto lock feature or carry out the following procedure.

**Note:** You will have 30 seconds to complete the procedure.

1. Switch the ignition on.



# Locks

2. Press the power door lock button three times.
3. Switch the ignition off.
4. Press the power door lock button three times.
5. Switch the ignition on. The horn will chirp indicating your vehicle is in programming mode.
6. Press the power door lock button for less than one second and release.

The horn will chirp once if disabled or twice (one short and one long chirp) if enabled.

After programming the feature, switch the ignition off. The horn will chirp once indicating programming is complete.

## Auto Unlock Feature

The auto unlock feature will unlock all the doors when all of the following conditions have been met:

- The ignition is on, all doors are closed, and your vehicle is moving at a speed greater than 12 mph (20 km/h) for more than two seconds.
- Your vehicle has come to a stop and you switch the ignition off or to the accessory position.
- The driver's door is opened within 10 minutes of you switching the ignition off or to the accessory position.

**Note:** *The doors will not auto unlock if your vehicle has been electronically locked after the ignition is turned off and before the driver's door is opened.*

## Enabling or Disabling Auto Unlock

**Note:** *See an authorized dealer to enable or disable the auto unlock feature or carry out the following procedure.*

**Note:** *You will have 30 seconds to complete the procedure.*

1. Switch the ignition on.

2. Press the power door lock button three times.
3. Switch the ignition off.
4. Press the power door lock button three times.
5. Switch the ignition on. The horn will chirp indicating your vehicle is in programming mode.
6. Press the power door lock button for longer than two seconds and release.

The horn will chirp once if disabled or twice (one short and one long chirp) if enabled.

After programming the feature, switch the ignition off. The horn will chirp once indicating programming is complete.

## Emergency Locking With the Key

**Note:** *If the child safety locks are on and you pull the interior handle, you will only turn off the emergency locking, not the child safety lock. You can only open the doors using the external door handle.*

**Note:** *If the doors have been unlocked using this method, the doors must be locked individually until the central locking function has been repaired.*

**Note:** *When the central locking function fails to operate, lock the doors individually using the key in the position shown.*

# Locks

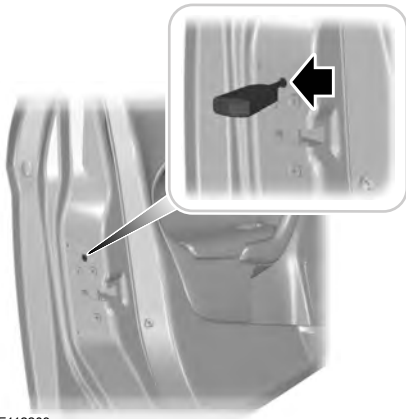

E112203

## Left-Hand Side

Turn clockwise to lock.

## Right-Hand Side

Turn counterclockwise to lock.

## MANUAL LIFTGATE

### WARNINGS



It is extremely dangerous to ride in the cargo area, inside or outside of your vehicle. In a collision, people riding in these areas are more likely to be seriously injured or killed. Do not allow people to ride in any area of your vehicle that does not have seats and safety belts. Make sure everyone in your vehicle is in a seat and using a safety belt correctly.



Make sure that the liftgate is closed to prevent exhaust fumes from being drawn into your vehicle. This will also prevent passengers and cargo from falling out. If you must drive with the liftgate door open, keep your vehicle well ventilated so outside air does not enter your vehicle.

**Note:** Be careful when opening or closing the liftgate in a garage or other enclosed area to avoid damaging the liftgate.

**Note:** Do not hang anything (bike rack, etc.) from the spoiler, glass or liftgate. This could damage the liftgate and its components.

**Note:** Do not leave the liftgate open while driving. This could damage the liftgate and its components.

## Opening and Closing the Liftgate

### To Open the Liftgate

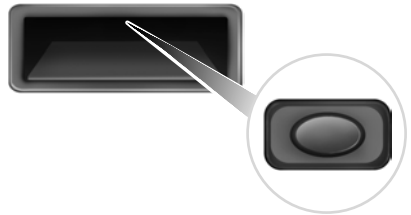

E138632

Press the button located in the top of the liftgate pull cup handle to unlatch the liftgate, then pull on the outside handle.

### Opening With the Remote Control



Press the button twice within three seconds.

# Locks

## To Close the Liftgate



E89132

A recessed grip is located inside the liftgate to help with closing.

## KEYLESS ENTRY

### General Information

#### WARNING



The system may not function if the key is close to metal objects or electronic devices such as cell phones.

The system will not function if:

- Your vehicle battery has no charge.
- The passive key frequencies are jammed.
- The passive key battery has no charge.

**Note:** *If the system does not function, you will need to use the key blade to lock and unlock your vehicle.*

The system allows you to operate your vehicle without the use of a key or remote control.



E78276

Passive locking and unlocking requires a valid passive key to be located within one of the three external detection ranges. These are located approximately five feet (one and a half meters) from the front door handles and the liftgate.

### Passive Key

Your vehicle can be locked and unlocked with the passive key. You can use the passive key as a remote control. See **Locking and Unlocking** (page 52).

### Locking Your Vehicle

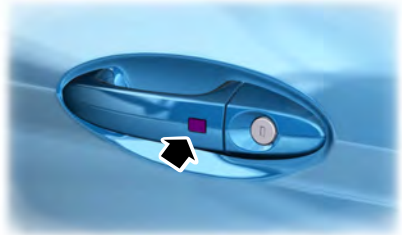

E87384

#### WARNING



Your vehicle does not lock itself automatically. If you do not press a locking button your vehicle will remain unlocked.

# Locks

Locking buttons are located on each of the front doors.

For central locking and to arm the alarm, press a locking button once.

For double locking and to arm the alarm, press a locking button twice within three seconds.

**Note:** *Your vehicle will remain locked for approximately three seconds. When the delay period is over, you can open the doors again, provided the passive key is within the respective detection range.*

Two short flashes of the direction indicators confirms that all the doors and the liftgate have been locked and that the alarm has been armed.

## Liftgate

**Note:** *The liftgate cannot be closed and will pop back up if the passive key is located inside the luggage compartment with the doors locked.*

**Note:** *If a second valid passive key is located within the liftgate detection range, the liftgate can be closed.*

## Unlocking Your Vehicle

**Note:** *When your vehicle remains locked for longer than three days, the system will enter an energy-saving mode. This is to prevent your vehicle battery running out of charge. When your vehicle is unlocked while in this mode, the reaction time of the system may be a little longer than normal. To exit the energy-saving mode, unlock your vehicle.*

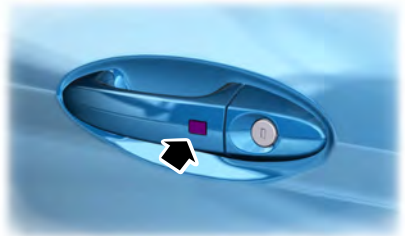

E87384

Press a locking button once.

**Note:** *A valid passive key must be located within the detection range of that door.*

One long flash of the direction indicators confirms that all the doors and the liftgate have been unlocked and that the alarm has been disarmed.

## Unlocking Only the Driver's Door

If the unlocking function is reprogrammed so that only the driver's door and the liftgate are unlocked. See **Remote Control** (page 43). Note the following:

If the driver's door is the first door which is opened, the other doors will remain locked. All the other doors can be unlocked from inside your vehicle by pressing the unlock button on the instrument panel.

## Disabled Keys

Any keys left inside your vehicle interior when it is locked will be disabled.

You cannot use a disabled key to switch the ignition on or start the engine.

You must enable all passive keys again in order to use them.

To enable all your passive keys, unlock your vehicle using a passive key or the remote control unlocking function.

All passive keys will then be enabled if you switch the ignition on or you start your vehicle with a valid key.

# Locks

## Locking and Unlocking the Doors With the Key Blade



E87964

1. Carefully remove the cover.
2. Remove the key blade and insert it into the lock.

**Note:** Only the driver's door handle has a lock cylinder.

## INTERIOR LUGGAGE COMPARTMENT RELEASE (IF EQUIPPED)

**EQUIPPED)**

### WARNINGS



Keep vehicle doors and luggage compartment locked and keep keys and remote transmitters out of a child's reach. Unsupervised children could lock themselves in the trunk and risk injury. Children should be taught not to play in vehicles.

### WARNINGS



Do not leave children, unreliable adults, or animals unattended in the vehicle. On hot days, the temperature in the trunk or vehicle interior can rise very quickly. Exposure of people or animals to these high temperatures for even a short time can cause death or serious heat-related injuries, including brain damage. Small children are particularly at risk.

Your vehicle is equipped with a release handle that provides a means of escape for children and adults if they become locked inside the luggage compartment.

Adults should familiarize themselves with the operation and location of the release handle.

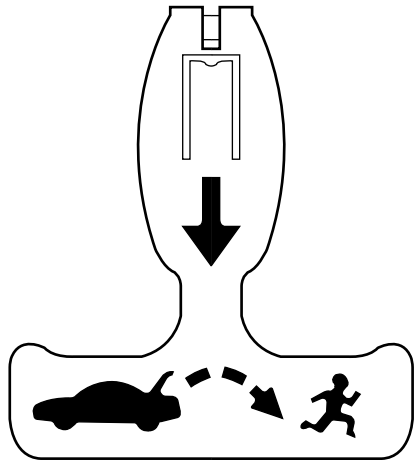

E144403

# Locks

---

The handle is located inside the luggage compartment either on the luggage compartment door (lid) or near the tail lamps. It is composed of a material that will glow for hours in darkness following brief exposure to ambient light.

Pull the handle and push up on the luggage compartment door (lid) to open from within the luggage compartment.

# Security

---

## PASSIVE ANTI-THEFT SYSTEM

**Note:** The system is not compatible with non-Ford aftermarket remote start systems. Use of these systems may result in vehicle starting problems and a loss of security protection.

**Note:** Metallic objects, electronic devices or a second coded key on the same key chain may cause vehicle starting problems if they are too close to the key when starting the engine. Prevent these objects from touching the coded key while starting the engine. Switch the ignition off, move all objects on the key chain away from the coded key and restart the engine if a problem occurs.

**Note:** Do not leave a duplicate coded key in the vehicle. Always take your keys and lock all doors when leaving the vehicle.

### SecuriLock®

The system is an engine immobilization system. It is designed to help prevent the engine from being started unless a coded key programmed to your vehicle is used. Using the wrong key may prevent the engine from starting. A message may appear in the information display.

If you are unable to start the engine with a correctly coded key, a malfunction has happened and a message may appear in the information display.

### Automatic Arming

The vehicle arms immediately after you switch the ignition off.

### Automatic Disarming

Switching the ignition on with a coded key disarms the vehicle.

## Replacement Keys

**Note:** Your vehicle comes equipped with two integrated keyhead transmitters or two intelligent access keys.

The integrated keyhead transmitter functions as a programmed ignition key that operates all the locks and starts the vehicle, as well as a remote control.

The intelligent access key functions as a programmed key that operates the driver door lock and activates the intelligent access with push button start system, as well as a remote control.

If your programmed transmitters or standard SecuriLock coded keys (integrated keyhead transmitters only) are lost or stolen and you do not have an extra coded key, you will need to have your vehicle towed to an authorized dealer. You need to erase the key codes from your vehicle and program new coded keys.

Store an extra programmed key away from the vehicle in a safe place to help prevent any inconveniences. See your authorized dealer to purchase additional spare or replacement keys.

### Programming a Spare Integrated Keyhead Transmitter

**Note:** You can program a maximum of eight coded keys to your vehicle. All eight can be integrated keyhead transmitters.

You can program your own integrated keyhead transmitter or standard SecuriLock coded keys to your vehicle. This procedure will program both the engine immobilizer keycode and the remote entry portion of the remote control to your vehicle

Only use integrated keyhead transmitters or standard SecuriLock keys.

# Security

---

You must have two previously programmed coded keys and the new unprogrammed key readily accessible. See your authorized dealer to have the spare key programmed if two previously programmed coded keys are not available.

Read and understand the entire procedure before you begin.

1. Insert the first previously programmed coded key into the ignition.
2. Switch the ignition from off to on. Keep the ignition on for at least three seconds, but no more than 10 seconds.
3. Switch the ignition off and remove the first coded key from the ignition.
4. After three seconds but within 10 seconds of switching the ignition off, insert the second previously coded key into the ignition.
5. Switch the ignition from off to on. Keep the ignition on for at least three seconds, but no more than 10 seconds.
6. Switch the ignition off and remove the second previously programmed coded key from the ignition.
7. After three seconds but within 10 seconds of switching the ignition off and removing the previously programmed coded key, insert the new unprogrammed key into the ignition.
8. Switch the ignition from off to on. Keep the ignition on for at least six seconds.
9. Remove the newly programmed coded key from the ignition.

If the key has been successfully programmed it will start the engine and operate the remote entry system (if the new key is an integrated keyhead transmitter).

If programming was not successful, wait 10 seconds and repeat Steps 1 through 8. If you are still unsuccessful, take your vehicle to your authorized dealer.

## Programming a Spare Intelligent Access Key

See your authorized dealer to have additional keys programmed to your vehicle.

## ANTI-THEFT ALARM

### Alarm System

The perimeter alarm is a deterrent against unauthorized access to your vehicle through the doors and the hood. It also protects the audio unit.

### Triggering the Alarm

Once armed, the alarm is triggered in any of the following ways:

- If someone opens a door, the liftgate or the hood without a valid key or remote control.
- If someone removes the audio or navigation system.
- If you switch the ignition on without a valid key.

If the alarm is triggered, the alarm horn will sound for 30 seconds and the hazard warning flasher will flash for five minutes.

Any further attempts to perform one of the above will trigger the alarm again.

### Arming the Alarm

To arm the alarm, lock your vehicle. See **Locks** (page 52).

### Disarming the Alarm

#### Vehicles Without Keyless Entry

Disarm and silence the alarm by unlocking the doors with the key and switching the ignition on with a correctly coded key or unlocking the doors with the remote control.



# Security

---

## Vehicles with Keyless Entry

**Note:** *A valid passive key must be located within the detection range of that door for keyless entry. See **Keyless Entry** (page 56).*

Disarm and silence the alarm by unlocking the doors and switching the ignition on or unlocking the doors with the remote control.

# Steering Wheel

## ADJUSTING THE STEERING WHEEL

### WARNING



Do not adjust the steering wheel when your vehicle is moving.

**Note:** Make sure that you are sitting in the correct position. See **Sitting in the Correct Position** (page 105).



E95178

1. Unlock the steering column.
2. Adjust the steering wheel to the desired position.



E95179

3. Lock the steering column.

## AUDIO CONTROL (IF EQUIPPED)

Select the required source on the audio unit.

You can operate the following functions with the control:

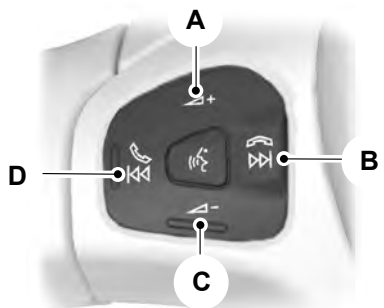

E141530

- A Volume up
- B Seek up, next or end call

# Steering Wheel

- C Volume down
- D Seek down, previous or accept call

## Seek, Next or Previous

Press the seek button to:

- tune the radio to the next or previous stored preset
- play the next or the previous track.

Press and hold the seek button to:

- tune the radio to the next station up or down the frequency band
- seek through a track.

## CRUISE CONTROL (IF EQUIPPED)



E141961

See **Cruise Control** (page 142).

## VOICE CONTROL (IF EQUIPPED)



E141533

Press the button to select or deselect voice control. See **SYNC™** (page 259).

# Wipers and Washers

## WINDSHIELD WIPERS

**Note:** Fully defrost the windshield before switching on the windshield wipers.

**Note:** Make sure the windshield wipers are switched off before entering a car wash.

**Note:** Install new wiper blades as soon as they begin to leave bands of water and smears on the windshield.

**Note:** Do not operate the wipers on a dry windshield. This may scratch the glass, damage the wiper blades or cause the wiper motor to burn out. Always use the windshield washers before wiping a dry windshield.

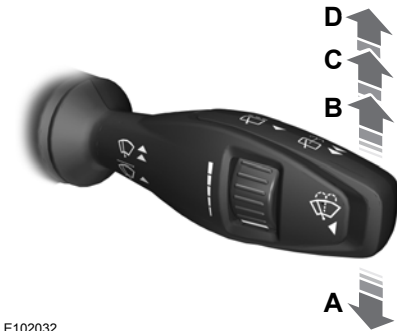

E102032

- A Single wipe
- B Intermittent wipe
- C Normal wipe
- D High speed wipe

**Note:** If you press and hold the wiper lever in position A, the wipers will continue to wipe until you release the wiper lever.

## Intermittent Wipe

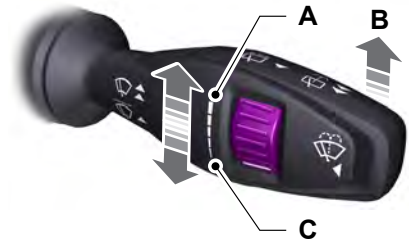

E102033

- A Short wipe interval
- B Intermittent wipe
- C Long wipe interval

Use the rotary control to adjust the intermittent wipe interval.

## Speed Dependent Wipers

When your vehicle speed increases, the interval between wipes will decrease.

## WINDSHIELD WASHERS

**Note:** Do not operate the washers when the washer reservoir is empty. This may cause the washer pump to overheat.



E102051

Push the button to operate the washers. When you release the button, the wipers will operate for a short time.

# Wipers and Washers

## REAR WINDOW WIPER AND WASHERS

### Intermittent Wipe



E102052

Pull the lever toward you.

### Reverse Gear Wipe

The rear wiper will turn on automatically when selecting reverse gear if:

- the rear wiper is not already switched on
- the wiper lever is in position A, B, C or D
- the front wiper is operating (when set to position B).

### Rear Window Washer

**Note:** Do not operate the washers when the washer reservoir is empty. This may cause the washer pump to overheat.

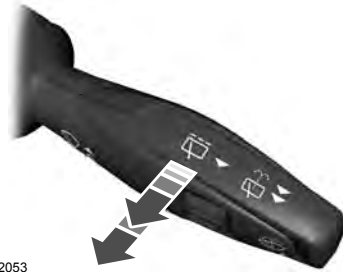

E102053

Pull the lever toward you to operate the washers. They will operate for a maximum of 10 seconds. When you release the lever, the wiper will operate for a short time.

# Lighting

## GENERAL INFORMATION

### Condensation in Lamp Assemblies

Exterior lamps have vents to accommodate normal changes in air pressure.

Condensation can be a natural by-product of this design. When moist air enters the lamp assembly through the vents, there is a possibility that condensation can occur when the temperature is cold. When normal condensation occurs, a fine mist can form on the interior of the lens. The fine mist eventually clears and exits through the vents during normal operation.

Clearing time may take as long as 48 hours under dry weather conditions.

Examples of acceptable condensation are:

- The presence of a fine mist (no streaks, drip marks or large droplets).
- A fine mist covers less than 50% of the lens.

Examples of unacceptable condensation are:

- A water puddle inside the lamp.
- Streaks, drip marks or large droplets present on the interior of the lens.

If you see any unacceptable condensation, have your vehicle checked by an authorized dealer.

## LIGHTING CONTROL

### Lighting Control Positions

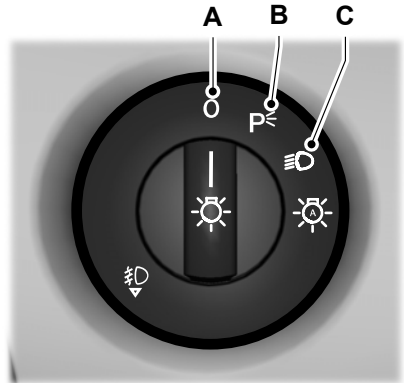

E156651

- A Off
- B Parking lamps, instrument panel lamps, license plate lamps and tail lamps
- C Headlamps

### Parking Lamps

**Note:** Prolonged use of the parking lamps when the ignition is off will cause the battery to run out of charge.

To operate the parking lamps turn the lighting control to position B. The parking lamps operate with the ignition on or off.

# Lighting

## High Beams



E101829

Pull the lever fully toward you to switch the high beams on.

Pull the lever fully toward you again to switch the high beams off.

## Headlamp Flasher

Pull the lever toward you slightly and release it to flash the headlamps.

## AUTOLAMPS (IF EQUIPPED)

**Note:** It may be necessary to switch your headlamps on manually in severe weather conditions.

**Note:** If you have autolamps on, you can only switch the high beam on once autolamps has switched the headlamps on.

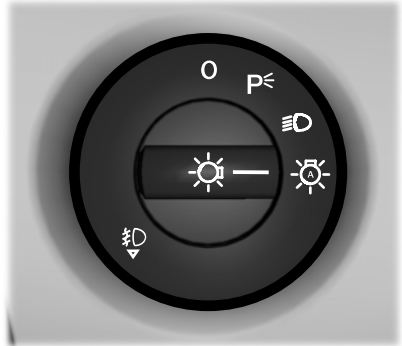

E158778

The headlamps will switch on and off automatically in low light situations or during inclement weather.

## INSTRUMENT LIGHTING DIMMER



E156652

# Lighting

## HEADLAMP EXIT DELAY

After you switch the ignition off, you can switch the headlamps on by pulling the direction indicator lever toward you. You will hear a short tone. The headlamps will switch off automatically after three minutes with any door open or 30 seconds after the last door has been closed. You can cancel this feature by pulling the direction indicator toward you again or switching the ignition on.

## DAYTIME RUNNING LAMPS (IF EQUIPPED)

### WARNING



Always remember to switch your headlamps on in low light situations or during inclement weather. The system does not turn on the tail lamps and may not provide adequate lighting during these conditions. Failure to switch the headlamps on under these conditions may result in a collision.

The system switches the headlamps on in daylight conditions.

To switch the system on:

1. Switch the ignition on.
2. Turn the lighting control to the off, autolamp or parking lamp position.
3. Make sure the transmission selector lever is not in position **P**.

## FRONT FOG LAMPS (IF EQUIPPED)

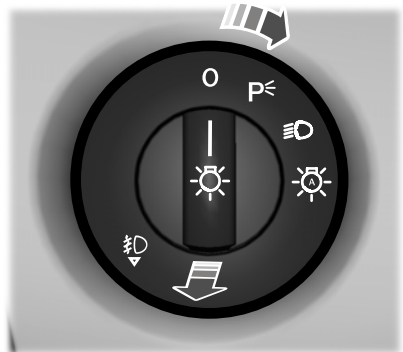

E156823

Pull the control to switch the fog lamps on or off.

You cannot switch the fog lamps on when the lighting control is in the off or autolamps position.

## DIRECTION INDICATORS



E102016

Push the lever up or down to use the direction indicators.

**Note:** Tap the lever up or down to make the direction indicators flash three times to indicate a lane change.



# Lighting

## INTERIOR LAMPS

### Front Interior Lamps

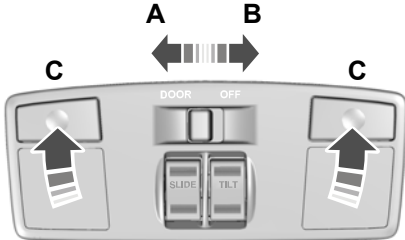

E156878

- A Door contact
- B Off
- C Reading lamps

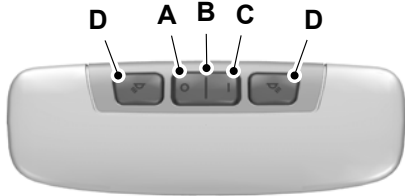

E170657

- A Off
- B Door contact
- C On
- D Reading lamps

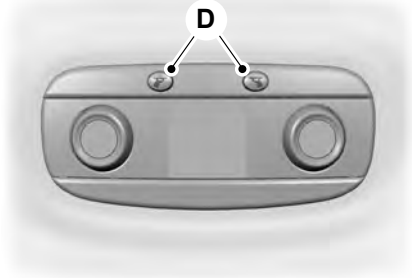

E170600

- D Reading lamps.

When the switch is set to the door contact position, the courtesy lamp will illuminate when you unlock or open a door or the liftgate. If you leave a door open with the ignition switched off, the courtesy lamp will go off automatically after some time to prevent your vehicle battery from losing charge. To switch it back on, switch the ignition on for a short time.

The courtesy lamp will also illuminate when you switch the ignition off. It will go off automatically after a short time or when you start the engine.

### Reading Lamps

If you switch the ignition off, the reading lamps will go off automatically after some time to prevent your vehicle battery from losing charge. To switch them back on, switch the ignition on for a short time.

### Rear Interior Lamps (If Equipped)

Press to switch individual lamps on and off.

# Lighting

## AMBIENT LIGHTING (IF EQUIPPED)

The ambient lighting system illuminates the interior with a choice of several colors. The ambient lighting control is located on the instrument panel.



E158830



Press and release the switch to cycle through the color choices and the off condition.

The ambient lighting will switch on when the following conditions have been met:

- You switch the ignition on.
- You switch the headlamps on.
- The exterior ambient light level is low.

The ambient lighting will remain on until you switch the ignition off and one of the following conditions have been met:

- You lock your vehicle.
- The accessory delay timer expires.

# Windows and Mirrors

## POWER WINDOWS (IF EQUIPPED)

### WARNINGS



Do not leave children unattended in your vehicle and do not let them play with the power windows. They may seriously injure themselves.



When closing the power windows, you should verify they are free of obstructions and make sure that children and pets are not in the proximity of the window openings.



E70848

**Note:** You may hear a pulsing noise when just one of the windows is open. Lower the opposite window slightly to reduce this noise.

Press the switch to open the window.

Lift the switch to close the window.

### One-Touch Down (If Equipped)

Press the switch fully and release it. Press again or lift it to stop the window.

### One-Touch Up (If Equipped)

Lift the switch fully and release it. Press or lift it again to stop the window.

## Window Lock



E70850

Press the control to lock or unlock the rear window controls. It will illuminate when the rear window controls are locked.

### Bounce-Back (If Equipped)

The window will stop automatically while closing. It will reverse some distance if there is an obstacle in the way.

### Overriding the Bounce-Back Feature

#### WARNING



When you override the bounce-back feature the window will not reverse if it detects an obstacle. Take care when closing the windows to avoid personal injury or damage to your vehicle.

Proceed as follows to override this protection feature when there is a resistance, for example in winter:

1. Close the window twice until it reaches the point of resistance and let it reverse.

# Windows and Mirrors

2. Close the window a third time to the point of resistance. The bounce-back feature is now disabled and you can close the window manually. The window will go past the point of resistance and you can close it fully.

See an authorized dealer as soon as possible if the window does not close after the third attempt.

## Resetting the Bounce-Back Feature

### WARNING



The bounce-back feature remains turned off until you reset the memory.

If you have disconnected the battery, you must reset the bounce-back memory separately for each window.

1. Lift and hold the switch until the window is fully closed.
2. Release the switch.
3. Lift the switch again for one more second.
4. Press and hold the switch until the window is fully open.
5. Release the switch.
6. Lift and hold the switch until the window is fully closed.
7. Open the window and then try to close it automatically.
8. Reset and repeat the procedure if the window does not close automatically.

## Accessory Delay (If Equipped)

You can use the window switches for several minutes after you have switched the ignition off or until either front door is opened.

## GLOBAL OPENING AND CLOSING (IF EQUIPPED)

You can also operate the power windows with the ignition off using the global opening and global closing function.

**Note:** *Global opening will only operate for a short period of time after you have unlocked your vehicle using the remote control.*

**Note:** *Global closing will only operate if you have set the memory correctly for each window. See **Power Windows** (page 72).*

## Global Opening

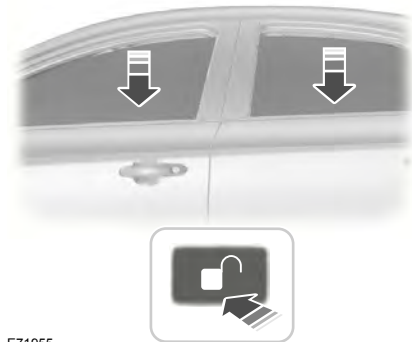

E71955

To open all the windows:

1. Press and release the remote control unlock button.
2. Press and hold the remote control unlock button for at least three seconds.

Press the lock or unlock button to stop the opening function.

# Windows and Mirrors

## Global Closing

### Vehicles Without Keyless Entry

#### WARNING



Take care when using global closing. In an emergency, press the lock or unlock button immediately to stop.

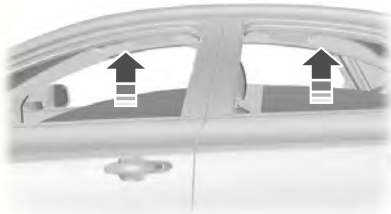

E71956

To close all the windows, press and hold the remote control lock button for at least three seconds. Press the lock or unlock button to stop the closing function. The bounce-back function is also on during global closing.

### Vehicles With Keyless Entry

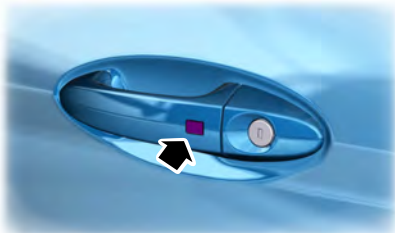

E87384

#### WARNING



Take care when using global closing. In an emergency, touch a door handle lock sensor to stop.

**Note:** *Global closing can be switched on using the driver's door handle. Global opening and closing can also be switched on using the buttons on the passive key.*

To close all the windows, press and hold the driver's door handle for at least three seconds. The bounce-back function is also on during global closing.

## EXTERIOR MIRRORS

### Power Exterior Mirrors

#### WARNING



Do not adjust the mirrors when your vehicle is moving. This could result in the loss of control of your vehicle, serious personal injury or death.

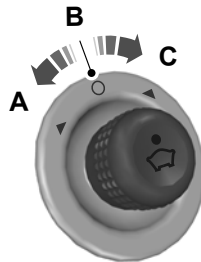

E71280

- A Left-hand mirror
- B Off
- C Right-hand mirror

# Windows and Mirrors

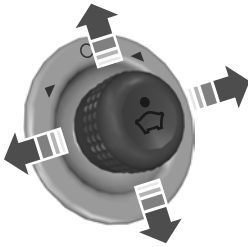

E71281

Move the controller in the direction of the arrows to adjust the mirror.

## Fold-Away Exterior Mirrors

Push the mirror toward the door window glass. Make sure that you fully engage the mirror in its support when returning it to its original position.

## Integrated Blind Spot Mirrors (if Equipped)

### WARNING



Objects in the blind spot mirror are closer than they appear.

Blind spot mirrors have an integrated convex mirror built into the upper outboard corner of the exterior mirrors. They are designed to increase your visibility along the side of your vehicle.

Check the main mirror first before a lane change, then check the blind spot mirror. If no vehicles are present in the blind spot mirror and the traffic in the adjacent lane is at a safe distance, signal that you intend to change lanes. Glance over your shoulder to verify traffic is clear and carefully change lanes.

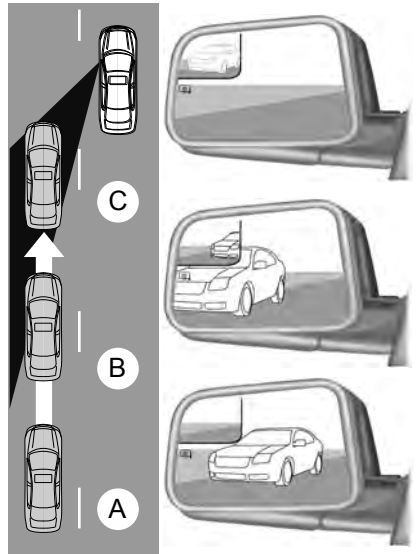

E138665

The image of the approaching vehicle is small and near the inboard edge of the main mirror when it is at a distance. The image becomes larger and begins to move outboard across the main mirror as the vehicle approaches (A). The image will transition from the main mirror and begin to appear in the blind spot mirror as the vehicle approaches (B). The vehicle will transition to your peripheral field of view as it leaves the blind spot mirror (C).

## INTERIOR MIRROR

### WARNING



Do not adjust the mirror when your vehicle is moving.

# Windows and Mirrors

**Note:** Do not clean the housing or glass of any mirror with harsh abrasives, fuel or other petroleum or ammonia-based cleaning products.

You can adjust the interior mirror to your preference. Some mirrors also have a second pivot point. This lets you move the mirror head up or down and from side to side.

Pull the tab below the mirror toward you to reduce glare at night.

## Auto-Dimming Mirror (If Equipped)

**Note:** Do not block the sensors on the front and back of the mirror. Mirror performance may be affected. A rear center passenger or raised rear center head restraint may also block light from reaching the sensor.

The mirror will dim automatically to reduce glare when bright lights are detected from behind your vehicle. It will automatically return to normal reflection when you select reverse gear to make sure you have a clear view when backing up.

## MOONROOF (IF EQUIPPED)

### WARNINGS



Do not allow people to play with the moonroof. Becoming trapped in a moonroof may result in serious injury or death.



You must make sure the moonroof is free of any obstruction when closing. Becoming trapped in a moonroof may result in serious injury or death.

The moonroof controls are located on the overhead console.



E156620

## Opening and Closing the Moonroof

Press and release the rear of the **SLIDE** control to open the moonroof. The sliding shade will automatically open, if closed, while the moonroof opens.

Press and hold the front of the **SLIDE** control to close the moonroof.

**Note:** The sliding shade will not automatically close.

## Moonroof Sliding Shade

You can manually open or close the sliding shade when the moonroof is closed. Slide the shade backward or forward to open or close it.

## Venting the Moonroof

Press and hold the rear of the **TILT** control to vent the moonroof.

Press and hold the front of the **TILT** control to close the moonroof.

# Instrument Cluster

## GAUGES

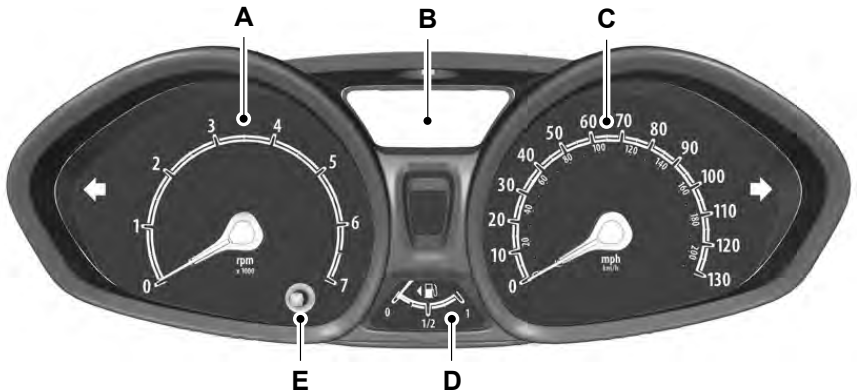

E102660

- A Tachometer
- B Information display and engine coolant temperature gauge
- C Speedometer
- D Fuel gauge
- E Tripmeter reset button

## Compass (If Equipped)

Displays the vehicle's heading direction.

To calibrate and set the compass zone use the information display menu. See **Information Displays** (page 85).

Use the diagram to determine your magnetic zone.

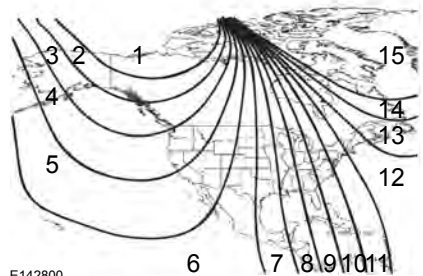

E142800



# Instrument Cluster

## Engine Coolant Temperature Gauge



E140760

Displays the temperature of the engine coolant. At normal operating temperature the indicator will remain in the center section.

## Fuel Gauge

Switch the ignition on. The fuel gauge will indicate approximately how much fuel is left in the fuel tank. The fuel gauge may vary slightly when your vehicle is moving or on a gradient. The arrow adjacent to the fuel pump symbol indicates on which side of your vehicle the fuel filler door is located.

## WARNING LAMPS AND INDICATORS

The following warning lamps and indicators will alert you to a vehicle condition that may become serious. Some lamps will illuminate when you start your vehicle to make sure they work. If any lamps remain on after starting your vehicle, refer to the respective system warning lamp for further information.

**Note:** Some warning indicators appear in the information display and function the same as a warning lamp but do not display when you start your vehicle.

## Anti-lock Braking System Warning Lamp



If it illuminates when you are driving, this indicates a malfunction. You will continue to have the normal braking system (without anti-lock braking system) unless the brake system warning lamp is also illuminated. Have your vehicle checked by an authorized dealer.

## Brake System Warning Lamp



It will illuminate when you engage the parking brake with the ignition on.

If it illuminates when you are driving, check that the parking brake is not engaged. If the parking brake is not engaged, this indicates low brake fluid level or a brake system malfunction. Have your vehicle checked immediately by an authorized dealer.

### WARNING



Driving your vehicle with the warning lamp on is dangerous. A significant decrease in braking performance may occur. It will take you longer to stop your vehicle. Have your vehicle checked by your authorized dealer immediately. Driving extended distances with the parking brake engaged can cause brake failure and the risk of personal injury.

## Cruise Control Indicator



It will illuminate when you switch this feature on. See **Using Cruise Control** (page 142).

# Instrument Cluster

## Direction Indicator



Illuminates when the left or right turn signal or the hazard warning flasher is turned on. If the indicators stay on or flash faster, check for a burnt out bulb. See **Changing a Bulb** (page 194).

## Door Ajar Warning Lamp



Illuminates when you switch the ignition on and remains on if any door, the hood or the liftgate is not closed properly.

## Engine Coolant Temperature Warning Lamp

### WARNING



Do not resume your journey if it illuminates despite the level being correct. Have your vehicle checked by an authorized dealer immediately.



If it stays on after starting or illuminates when driving, this indicates a malfunction. Stop your vehicle as soon as it is safe to do so and switch the engine off. Check the coolant level. See **Engine Coolant Check** (page 183).

## Engine Oil Warning Lamp

### WARNING



Do not resume your journey if it illuminates despite the level being correct. Have your vehicle checked by an authorized dealer immediately.



If it illuminates with the engine running or when you are driving, this indicates a malfunction. Stop your vehicle as soon as it is safe to do so and switch the engine off. Check the engine oil level. See **Engine Oil Check** (page 182).

## Engine Warning Lamps



Malfunction Indicator Lamp



Powertrain Warning Lamp

## All Vehicles

If either lamp illuminates when the engine is running, this indicates a malfunction. The engine will continue to run but it may have limited power. If it flashes when you are driving, reduce the speed of your vehicle immediately. If it continues to flash, avoid heavy acceleration or deceleration. Have your vehicle checked by an authorized dealer immediately.

### WARNING



Have this checked immediately.

If both lamps illuminate together, stop your vehicle as soon as it is safe to do so (continued use may cause reduced power and cause the engine to stop). Switch the ignition off and attempt to restart the engine. If the engine restarts have your vehicle checked by an authorized dealer immediately. When the engine does not restart have your vehicle checked before continuing your journey.

# Instrument Cluster

## Front Airbag Warning Lamp



If it fails to illuminate when you start your vehicle, continues to flash or remains on, it indicates a malfunction. Have your vehicle checked by an authorized dealer.

## Front Fog Lamps Indicator



It will illuminate when you switch the front fog lamps on.

## Headlamp Indicator



It will illuminate when you switch the headlamp dipped beam or the side and tail lamps on.

## High Beam Indicator



It will illuminate when you switch the high beam headlamps on. It will flash when you use the headlamp flasher.

## Ignition Warning Lamp



If it illuminates when driving, this indicates a malfunction. Switch off all unnecessary electrical equipment. Have your vehicle checked by an authorized dealer immediately.

## Information Indicator



It will illuminate when a new message is stored in the information display. See

**Information Messages** (page 89).

## Low Fuel Level Warning Lamp



If it illuminates, refuel as soon as possible.

## Low Tire Pressure Warning



It will illuminate when your tire pressure is low. If the lamp remains on with the engine running or when driving, check your tire pressure as soon as possible.

It will also illuminate momentarily when you switch the ignition on to confirm the lamp is functional. If it does not illuminate when you switch the ignition on, or begins to flash at any time, have your vehicle checked by an authorized dealer.

## Safety Belt Minder Warning Lamp



It will illuminate and a chime will sound to remind you to fasten your safety belt. See **Safety Belt Minder** (page 30).

## Service Engine Soon



If it remains illuminated after you start the engine, it indicates that the on board diagnostics system has detected a malfunction to the emissions control system. See **Emission Control System** (page 123).

If it flashes, engine misfire is occurring which could damage your catalytic converter. Drive in a moderate fashion (avoid heavy acceleration and deceleration) and have your vehicle serviced immediately.

**Note:** *Under engine misfire conditions, excessive exhaust temperatures could damage the catalytic converter or other vehicle components.*

The service engine soon indicator light illuminates when you switch the ignition on prior to engine start to check the bulb and to indicate whether your vehicle is ready for inspection maintenance testing.

# Instrument Cluster

Normally, the lamp will remain on until the engine is cranked, then turn itself off if a malfunction is not present. However, if after 15 seconds the lamp flashes eight times, it means that your vehicle is not ready for inspection maintenance testing. See **Emission Control System** (page 123).

## Shift Indicator



It will illuminate to inform you that shifting to a higher gear may give better fuel economy and lower CO2 emissions. It will not illuminate during periods of high acceleration, braking or when the clutch pedal is pressed.

## Stability Control Indicator



While driving, it flashes when the system is operating. After you switch the ignition on, if it does not illuminate or illuminates continuously while driving, this indicates a malfunction. During a malfunction, the system switches off. Have your vehicle checked by an authorized dealer as soon as possible.

It will illuminate when you switch the system off. It will go out when you switch the system back on or when you switch the ignition off.

## WARNING LAMPS AND INDICATORS - 1.6L ECOBOOST™

The following warning lamps and indicators will alert you to a vehicle condition that may become serious. Some lamps will illuminate when you start your vehicle to make sure they work. If any lamps remain on after starting your vehicle, refer to the respective system warning lamp for further information.

**Note:** Some warning indicators appear in the information display and function the same as a warning lamp but do not display when you start your vehicle.

## Anti-lock Braking System Warning Lamp



If it illuminates when you are driving, this indicates a malfunction. You will continue to have the normal braking system (without anti-lock braking system) unless the brake system warning lamp is also illuminated. Have your vehicle checked by an authorized dealer.

## Brake System Warning Lamp



It will illuminate when you engage the parking brake with the ignition on.

If it illuminates when you are driving, check that the parking brake is not engaged. If the parking brake is not engaged, this indicates low brake fluid level or a brake system malfunction. Have your vehicle checked immediately by an authorized dealer.

### WARNING



Driving your vehicle with the warning lamp on is dangerous. A significant decrease in braking performance may occur. It will take you longer to stop your vehicle. Have your vehicle checked by your authorized dealer immediately. Driving extended distances with the parking brake engaged can cause brake failure and the risk of personal injury.

## Cruise Control Indicator



It will illuminate when you switch this feature on. See **Using Cruise Control** (page 142).

# Instrument Cluster

## Direction Indicator



Illuminates when the left or right turn signal or the hazard warning flasher is turned on. If the indicators stay on or flash faster, check for a burnt out bulb. See **Changing a Bulb** (page 194).

## Door Ajar Warning Lamp



Illuminates when you switch the ignition on and remains on if any door, the hood or the liftgate is not closed properly.

## Engine Coolant Temperature Warning Lamp

### WARNING



Do not resume your journey if it illuminates despite the level being correct. Have your vehicle checked by an authorized dealer immediately.



If it stays on after starting or illuminates when driving, this indicates a malfunction. Stop your vehicle as soon as it is safe to do so and switch the engine off. Check the coolant level. See **Engine Coolant Check** (page 183).

## Engine Oil Warning Lamp

### WARNING



Do not resume your journey if it illuminates despite the level being correct. Have your vehicle checked by an authorized dealer immediately.



If it illuminates with the engine running or when you are driving, this indicates a malfunction. Stop your vehicle as soon as it is safe to do so and switch the engine off. Check the engine oil level. See **Engine Oil Check** (page 182).

## Engine Warning Lamps



Malfunction Indicator Lamp



Powertrain Warning Lamp

## All Vehicles

If either lamp illuminates when the engine is running, this indicates a malfunction. The engine will continue to run but it may have limited power. If it flashes when you are driving, reduce the speed of your vehicle immediately. If it continues to flash, avoid heavy acceleration or deceleration. Have your vehicle checked by an authorized dealer immediately.

### WARNING



Have this checked immediately.

If both lamps illuminate together, stop your vehicle as soon as it is safe to do so (continued use may cause reduced power and cause the engine to stop). Switch the ignition off and attempt to restart the engine. If the engine restarts have your vehicle checked by an authorized dealer immediately. When the engine does not restart have your vehicle checked before continuing your journey.

# Instrument Cluster

## Front Airbag Warning Lamp



If it fails to illuminate when you start your vehicle, continues to flash or remains on, it indicates a malfunction. Have your vehicle checked by an authorized dealer.

## Front Fog Lamps Indicator



It will illuminate when you switch the front fog lamps on.

## Headlamp Indicator



It will illuminate when you switch the headlamp dipped beam or the side and tail lamps on.

## High Beam Indicator



It will illuminate when you switch the high beam headlamps on. It will flash when you use the headlamp flasher.

## Ignition Warning Lamp



If it illuminates when driving, this indicates a malfunction. Switch off all unnecessary electrical equipment. Have your vehicle checked by an authorized dealer immediately.

## Information Indicator



It will illuminate when a new message is stored in the information display. See **Information Messages** (page 89).

## Low Fuel Level Warning Lamp



If it illuminates, refuel as soon as possible.

## Low Tire Pressure Warning



It will illuminate when your tire pressure is low. If the lamp remains on with the engine running or when driving, check your tire pressure as soon as possible.

It will also illuminate momentarily when you switch the ignition on to confirm the lamp is functional. If it does not illuminate when you switch the ignition on, or begins to flash at any time, have your vehicle checked by an authorized dealer.

## Safety Belt Minder Warning Lamp



It will illuminate and a chime will sound to remind you to fasten your safety belt. See **Safety Belt Minder** (page 30).

## Service Engine Soon



If it remains illuminated after you start the engine, it indicates that the on board diagnostics system has detected a malfunction to the emissions control system. See **Emission Control System** (page 123).

If it flashes, engine misfire is occurring which could damage your catalytic converter. Drive in a moderate fashion (avoid heavy acceleration and deceleration) and have your vehicle serviced immediately.

**Note:** *Under engine misfire conditions, excessive exhaust temperatures could damage the catalytic converter or other vehicle components.*

The service engine soon indicator light illuminates when you switch the ignition on prior to engine start to check the bulb and to indicate whether your vehicle is ready for inspection maintenance testing.

# Instrument Cluster

---

Normally, the lamp will remain on until the engine is cranked, then turn itself off if a malfunction is not present. However, if after 15 seconds the lamp flashes eight times, it means that your vehicle is not ready for inspection maintenance testing. See **Emission Control System** (page 123).

## Shift Indicator



It will illuminate to inform you that shifting to a higher gear may give better fuel economy and lower CO2 emissions. It will not illuminate during periods of high acceleration, braking or when the clutch pedal is pressed.

## AUDIBLE WARNINGS AND INDICATORS

### Automatic Transmission

Sounds when you open the driver's door and do not move the transmission selector lever to position **P**.

### Key Outside Car

#### Vehicles With Keyless System

Sounds when you close the door, the engine is running and the system does not detect a passive key inside your vehicle.

### Headlamps On

Sounds when you remove the key from the ignition and open the driver's door and you have left the headlamps or parking lamps on.

### Low Fuel

A warning chime will sound when the remaining fuel is less than approximately 1.3 gallons (6 liters). The distance to empty displayed may vary depending on driving style and road conditions.

## Safety Belt Minder

### WARNINGS



The safety belt minder remains in stand-by mode when the front safety belts have been fastened. It will sound if either safety belt is unfastened.



Do not sit on top of a fastened safety belt to prevent the safety belt minder from coming on. The occupant protection system will only provide optimum protection when you use the safety belt properly.

---

Sounds when your vehicle speed exceeds the pre-determined limit and the front safety belts are unfastened. The chime will stop after a period of time.

# Information Displays

## GENERAL INFORMATION

### WARNING



Driving while distracted can result in loss of vehicle control, crash and injury. We strongly recommend that you use extreme caution when using any device that may take your focus off the road. Your primary responsibility is the safe operation of your vehicle. We recommend against the use of any hand-held device while driving and encourage the use of voice-operated systems when possible. Make sure you are aware of all applicable local laws that may affect the use of electronic devices while driving.

**Note:** *The information display will remain on for several minutes after you switch the ignition off.*

### Device List

The icon changes to show the current function in use.



CD



Radio



Auxiliary input

## Information Display Controls



E103626

Various systems on your vehicle can be controlled using the information display controls on your audio unit. Corresponding information is displayed in the information display.

To use the controls:

- Press the up or down arrow button to scroll through and highlight the options within a menu.
- Press the right arrow button to enter a submenu.
- Press the left arrow button to exit a submenu.
- Press and hold the left arrow button at any time to return to the main menu display.
- Press the **OK** button to choose and confirm settings or messages.

### Menu Structure - Information Display

You can access the menu using the information display control.

**Note:** *Some options may appear slightly different or not at all if the items are optional.*

SYNC-Media allows you to access the SYNC® features.



# Information Displays

<b>SYNC-Phone</b>
Dial a number
Redial
Phonebook
Call history
Speed Dial
Text messaging
BT Devices
Phone settings

<b>Menu</b>	
Ford EcoMode	
SYNC-Settings	Bluetooth on
	Set defaults
	Master reset
	Install on SYNC
	System info
	Voice settings
SYNC-Apps	
Navigation	Route options
	Map display
	Assistance options
	Personal data
	Reset all settings
Audio settings	Adaptive volume
	Sound
	NAV audio mixing

# Information Displays

<b>Menu</b>	
	DSP settings
	DSP equalizer
	Traffic
	News
	Alt. frequency
	RDS Regional
Vehicle settings	Traction Control
	ESC
	Hill start assist
	Alarm system
	Powerfold mirrors
	Indicator
	Ambient light
Chimes	
Clock settings	Auto time (GPS)
	Set time
	Set date
	Set time zone
	24-hour mode
Display settings	Measure Unit
	Language
	Dimming
MyKey	create MyKey
	Traction control
	ESC
	Speed limit
	Speed warning

# Information Displays

Menu	
	Volume limit
	Information
	clear all MyKeys
MyKey active	Information

## System Check

All active warnings will display first if applicable. The system check menu may appear different based upon equipment options and current vehicle status. Press the up or down arrow button to scroll through the list.

## CLOCK

### Type 1

To adjust the clock, switch the ignition on and press buttons H or M on the information and entertainment display as necessary.

### Type 2

**Note:** Use the information display to adjust the clock. See **General Information** (page 85).

## TRIP COMPUTER



E102759

Press the button to scroll through the displays.

**Ø MPG** You can reset the trip, average fuel consumption and average speed. Scroll to the required display, then press and hold the button, this will reset the trip computer.

The trip computer includes the following information displays:

### Trip Odometer

**MI TRIP** Registers the distance traveled of individual journeys.

**KM TRIP**

### Distance to Empty

**MI TO E** Indicates the approximate distance your vehicle will travel on the fuel remaining in the tank. The distance to empty displayed may vary depending on driving style and road conditions.

**KM TO E**

### Average Fuel Consumption

**Ø MPG** Indicates the average fuel consumption since the function was last reset.

**Ø L / 100KM**

# Information Displays

## Average Speed



Indicates the average speed calculated since the function was last reset.



## Distance Odometer



Registers the total distance your vehicle has traveled.



## PERSONALIZED SETTINGS

### Measure Units

To swap between imperial and metric units, scroll to this display and press the **OK** button.

Swapping between imperial and metric units will affect the following displays:

- Distance to empty.
- Average fuel consumption.
- Instantaneous fuel consumption.
- Average speed.

### Switching Chimes Off

To switch chimes off, scroll to this display and press the **OK** button.

The following chimes can be switched off:

- Warning messages.
- Information messages.

## INFORMATION MESSAGES

**Note:** Depending on the options on your vehicle, not all of the messages will display or be available. Certain messages may be abbreviated or shortened depending upon which cluster type you have.



E103626

Press the **OK** button to acknowledge and remove some messages from the information display. Other messages will be removed automatically after a short time.

Certain messages need to be confirmed before you can access the menus.



The message indicator illuminates to supplement some messages. It will be red or amber depending on the severity of the message and will remain on until the cause of the message has been rectified.

Some messages will be supplemented by a system specific symbol with a message indicator.

# Information Displays

## Airbag

Message	Message indicator	Action
Airbag malfunction Service now	Amber	Have the system checked by an authorized dealer as soon as possible.

## Alarm

Message	Message indicator	Action
Alarm triggered Check vehicle	Amber	See <b>Security</b> (page 60).
Interior scan deactivated	Amber	See <b>Security</b> (page 60).
Alarm system malfunction Service required	-	Have the system checked by an authorized dealer.

## Doors Open

Message	Message indicator	Action
Driver door open	Red	Vehicle is moving. Stop your vehicle as soon as safely possible and close.
Driver side rear door open	Red	Vehicle is moving. Stop your vehicle as soon as safely possible and close.
Passenger door open	Red	Vehicle is moving. Stop your vehicle as soon as safely possible and close.
Passenger side rear door open	Red	Vehicle is moving. Stop your vehicle as soon as safely possible and close.
Trunk open	Red	Vehicle is moving. Stop your vehicle as soon as safely possible and close.

## Information Displays

Message	Message indicator	Action
Hood open	Red	Vehicle is moving. Stop your vehicle as soon as safely possible and close. See <b>Opening and Closing the Hood</b> (page 177).
Driver door open	Amber	Vehicle not moving. Close.
Driver side rear door open	Amber	Vehicle not moving. Close.
Passenger door open	Amber	Vehicle not moving. Close.
Passenger side rear door open	Amber	Vehicle not moving. Close.
Trunk open	Amber	Vehicle not moving. Close.
Hood open	Amber	Vehicle not moving. Close. See <b>Opening and Closing the Hood</b> (page 177).

### Engine Immobilizer

Message	Message indicator	Action
Immobilizer malfunction Service now	Red	Have the system checked by an authorized dealer as soon as possible.

### Hill Start Assist

Message	Message indicator	Action
Hill start assist not available	Amber	See <b>Hill Start Assist</b> (page 132).

### Keyless System

Message	Message indicator	Action
Key not detected	Amber	See <b>Keyless Entry</b> (page 56).
Key outside car	Amber	See <b>Keyless Entry</b> (page 56).
Key Battery low Replace battery	Amber	See <b>Remote Control</b> (page 43).

## Information Displays

Message	Message indicator	Action
Switch ign. off Press ENGINE Start/ Stop button	Amber	See <b>Keyless Starting</b> (page 113).
Press brake to start	-	See <b>Keyless Starting</b> (page 113).
Press clutch to start	-	See <b>Keyless Starting</b> (page 113).
Close trunk or use spare key	-	See <b>Keyless Entry</b> (page 56).

### Lighting

Message	Message indicator	Action
Left indicator malfunction Change bulb	-	See <b>Changing a Bulb</b> (page 194).
Right indicator malfunction Change bulb	-	See <b>Changing a Bulb</b> (page 194).

### Maintenance

Message	Message indicator	Action
Brake fluid level low Service now	Red	See <b>Brake Fluid Check</b> (page 185).
Brake system malfunction Stop safely	Red	Have the system checked by an authorized dealer immediately.
Engine oil pressure low Stop safely	Red	See <b>Engine Oil Check</b> (page 182).
Engine malfunction Service now	Amber	Have the system checked by an authorized dealer as soon as possible.
Engine oil change due Service required	-	Have the system checked by an authorized dealer.

# Information Displays

## MyKey

Message	Message indicator	Action
MyKey Vehicle at top speed	Amber	Displays when a MyKey is in use and the MyKey speed limit is on and your vehicle speed is approaching 80 mph (130 km/h).
MyKey active Drive safely	-	Displays when MyKey is active.
MyKey Speed limited to <XX> mph	-	Displays when starting your vehicle and MyKey is in use and the MyKey speed limit is on.
MyKey Speed limited to <XXX> km/h	-	Displays when starting your vehicle and MyKey is in use and the MyKey speed limit is on.
MyKey check speed Drive safely	-	Displays when MyKey is active.
MyKey vehicle near top speed	-	Displays when a MyKey is in use and the MyKey speed limit is reached.
MyKey Buckle up to unmute audio	-	Displays when a MyKey is in use and Belt- Minder is activated.
MyKey Park aid cannot be deactivated	-	Displays when a MyKey is in use and park aid is activated.
MyKey ESC cannot be deactivated	-	Displays when programming a MyKey.

## Parking Brake

Message	Message indicator	Action
Park brake applied	Red	See <b>Parking Brake</b> (page 134).
Park brake applied	Amber	See <b>Parking Brake</b> (page 134).



# Information Displays

## Stability Control

Message	Message indicator	Action
Electronic stability control off	Amber	See <b>Using Stability Control</b> (page 137).
ABS malfunction Service Now	Amber	Have the system checked by an authorized dealer as soon as possible.
Traction control off	-	See <b>Using Stability Control</b> (page 137).
Sport mode	-	See <b>Using Stability Control</b> (page 137).
Electronic stability control off	-	See <b>Using Stability Control</b> (page 137).

## Starting and Stopping the Engine

Message	Message indicator	Action
Press brake to start	-	See <b>Starting and Stopping the Engine</b> (page 113).
Press clutch to start	-	See <b>Starting and Stopping the Engine</b> (page 113).
Press brake and clutch to start	-	See <b>Starting and Stopping the Engine</b> (page 113).
Cranking time exceeded	-	See <b>Starting and Stopping the Engine</b> (page 113).

## Steering

Message	Message indicator	Action
Steering assist fault Service required	Amber	Full steering will be maintained but you will need to exert greater force on the steering wheel. Have the system checked by an authorized dealer as soon as possible.

# Information Displays

## Tire pressure monitoring system

Message	Message indicator	Action
Check tire pressures	Amber	The pressure in one or more tires has dropped. Check as soon as possible.
Tire Pressure Monitor Fault	Amber	Permanent malfunction. Have your vehicle checked by an authorized dealer.

## Transmission

Message	Message indicator	Action
Transmission malfunction Service now	Red	Have the system checked by an authorized dealer immediately.
Transmission overtemperature Stop safely	Red	Under certain driving conditions it is possible that the clutches in the transmission can overheat. In these circumstances it is necessary to press the brake pedal and stop your vehicle to prevent damage to the transmission. Move the transmission selector lever to position <b>N</b> or <b>P</b> and apply the parking brake until the transmission has cooled and the message disappears from the display.
Use brake Stop safely	Red	Have the system checked by an authorized dealer immediately.
Vehicle not in Park Select P	-	See <b>Automatic Transmission</b> (page 128). See <b>Starting and Stopping the Engine</b> (page 113).
Select N or P to start	-	See <b>Automatic Transmission</b> (page 128). See <b>Starting and Stopping the Engine</b> (page 113).
Press brake to start	-	See <b>Starting and Stopping the Engine</b> (page 113).

## Information Displays

Message	Message indicator	Action
Select N to start	-	See <b>Automatic Transmission</b> (page 128). See <b>Starting and Stopping the Engine</b> (page 113).
Door open Apply brake	-	See <b>Automatic Transmission</b> (page 128). See <b>Starting and Stopping the Engine</b> (page 113).
Transmission hot Stop or speed up	-	Transmission is getting hot. Stop to let it cool or speed up.
Transmission hot Wait...	-	Transmission is hot. Wait as needed to let it cool.
Transmission ready	-	Your vehicle is ready to drive.
Press brake to unlock gearshift lever	-	See <b>Automatic Transmission</b> (page 128). See <b>Starting and Stopping the Engine</b> (page 113).
Gearshift lever unlocked	-	See <b>Automatic Transmission</b> (page 128). See <b>Starting and Stopping the Engine</b> (page 113).
Transmission not in Park	-	See <b>Automatic Transmission</b> (page 128). See <b>Starting and Stopping the Engine</b> (page 113).

# Climate Control

## PRINCIPLE OF OPERATION

### Outside Air

Keep the air intakes in front of the windshield free from obstruction (such as snow or leaves) to allow the climate control system to function effectively.

### Recirculated Air

#### WARNING



Prolonged use of recirculated air may cause the windows to mist up. If the windows mist up, follow the settings for demisting the windshield.

The air currently in the passenger compartment recirculates. Outside air does not enter your vehicle.

### Heating

Heating performance depends on the temperature of the engine coolant.

### Air Conditioning

**Note:** The air conditioning operates only when the temperature is above 39°F (4°C).

**Note:** When you use air conditioning, your vehicle uses more fuel.

The system directs air through the evaporator for cooling. The evaporator extracts humidity from the air to help keep the windows free of mist. The system directs the resulting condensation to the outside of your vehicle, which may cause a small pool of water to form under your vehicle. This is normal.

### General Information on Controlling the Interior Climate

Fully close all the windows.

### Warming the Interior

Direct the air toward your feet. In cold or humid weather conditions, direct some of the air toward the windshield and the door windows.

### Cooling the Interior

Direct the air toward your face.

## AIR VENTS

### Center Air Vents

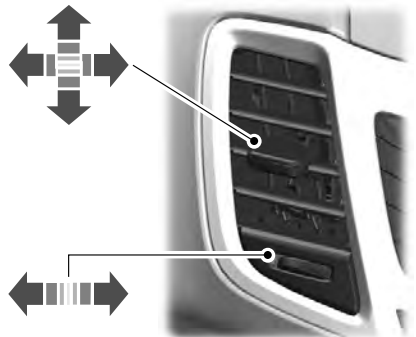

E147812

### Side Air Vent



E71942

# Climate Control

## MANUAL CLIMATE CONTROL

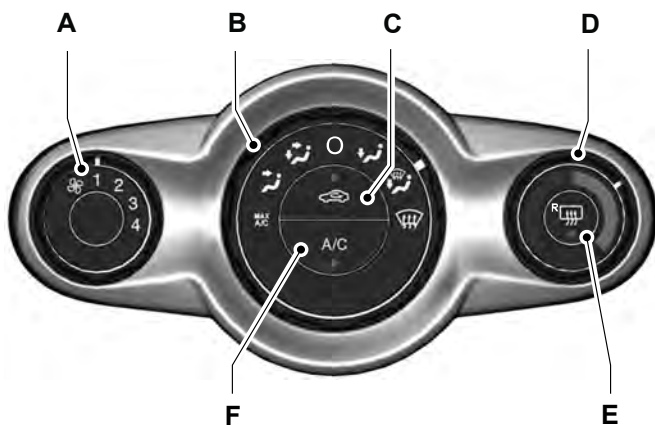

E158234

- A **Fan speed control:** Controls the volume of air circulated in your vehicle. Adjust to select the desired fan speed.
- B **Air distribution control:** Adjust to select the desired air distribution. If you select **MAX A/C** the system distributes recirculated air through the instrument panel air vents. This mode is more economical and efficient than normal air conditioning. Select **O** to turn the system off.
- C **Recirculated air:** Press the button to switch between outside air and recirculated air. When you select recirculated air, the button illuminates and the air currently in the passenger compartment recirculates. This can reduce the time needed to cool the interior and reduce unwanted odors from entering your vehicle.
- D **Temperature control:** Controls the temperature of the air circulated in your vehicle. Adjust to select the desired temperature.
- E **Heated rear window:** Press the button to defog and clear the rear window of a thin covering of ice.
- F **Air conditioning:** Press the button to switch the air conditioning on or off. Air conditioning cools your vehicle using outside air. To improve air conditioning when starting your vehicle, drive with the windows slightly open for two to three minutes.

# Climate Control

## AUTOMATIC CLIMATE CONTROL (IF EQUIPPED)

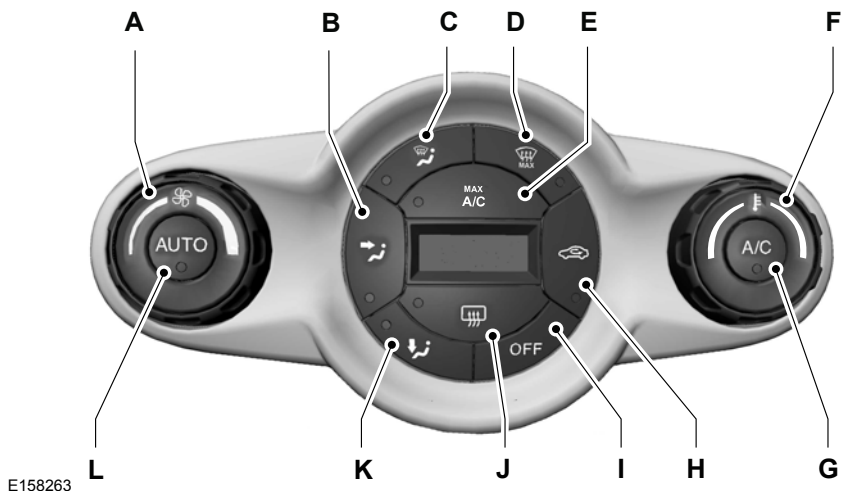

E158263

- A **Fan speed:** Controls the volume of air circulated in your vehicle. Rotate the control to select the desired fan speed. The setting is shown in the display.
- B **Instrument panel:** Press the button to distribute air through the instrument panel air vents.
- C **Windshield:** Press the button to distribute air through the windshield air vents. You can also use this setting to defog and clear the windshield of a thin covering of ice.
- D **MAX Defrost:** Press the button to distribute outside air through the windshield air vents. Air conditioning is automatically selected. The fan is set to the highest speed and the temperature to HI. When the air distribution is set in this position, you are unable to select recirculated air or manually adjust the fan speed and temperature control. Press the **AUTO** button to return to auto mode.
- E **MAX A/C:** Press the button to distribute recirculated air through the instrument panel air vents. This mode is more economical and efficient than normal air conditioning.
- F **Temperature control:** Controls the temperature of the air circulated in your vehicle. Adjust to select the desired temperature.

# Climate Control

- G **Air conditioning:** Press the button to switch the air conditioning on or off. Air conditioning cools your vehicle using outside air. To improve air conditioning when starting your vehicle, drive with the windows slightly open for two to three minutes.
- H **Recirculated air:** Press the button to switch between outside air and recirculated air. The air currently in the passenger compartment recirculates. This can reduce the time needed to cool the interior and reduce unwanted odors from entering your vehicle.
- I **Off button:** Press the button to switch the system off.
- J **Heated rear window:** Press the button to defog and clear the rear window of a thin covering of ice.
- K **Footwell:** Press the button to distribute air through the footwell air vents.
- L **AUTO:** Press the button to switch the system on and off. The system automatically controls the temperature, amount and distribution of the airflow to reach and maintain your previously selected temperature.

## Temperature Control



E148690

You can set the temperature between 61°F (16°C) and 82°F (28°C). In position low, the system switches to permanent cooling. In position high, the system switches to permanent heating.

**Note:** If you select either position low or high, the system will not regulate a stable temperature.

## HINTS ON CONTROLLING THE INTERIOR CLIMATE

### General Hints

**Note:** Prolonged use of recirculated air may cause the windows to fog up.

**Note:** A small amount of air may be felt from the footwell air vents regardless of the air distribution setting.

**Note:** To reduce humidity build-up inside your vehicle, do not drive with the system switched off or with recirculated air always switched on.

**Note:** Do not place objects under the front seats as this may interfere with the airflow to the rear seats.

**Note:** Remove any snow, ice or leaves from the air intake area at the base of the windshield.

# Climate Control

## Manual Climate Control

**Note:** To reduce fogging of the windshield during humid weather, adjust the air distribution control to the windshield air vents position. Increase the temperature and fan speed to improve clearing, if required.

## Automatic Climate Control

**Note:** Do not adjust the settings when your vehicle interior is extremely hot or cold. The system automatically adjusts to the previously stored settings. For the system to function efficiently, the instrument panel and side air vents should be fully open.

**Note:** At low ambient temperatures with **AUTO** selected, the air stream is directed toward the windshield and side windows for as long as the engine remains cold.

**Note:** When the system is switched off, outside air is prevented from entering your vehicle.

**Note:** When you select **AUTO** mode and the interior and exterior temperatures are high, the system automatically selects recirculated air to maximize cooling of the interior. When the desired air temperature is reached, the system automatically selects outside air.

**Note:** When you select windshield defrosting and defogging, the instrument panel and footwell level functions automatically switch off and air conditioning switches on. Outside air flows into your vehicle.

## Heating the Interior Quickly

	Vehicles With Manual Climate Control	Vehicles With Automatic Climate Control
1	Adjust the fan speed to the highest setting.	Press the <b>AUTO</b> button.
2	Adjust the temperature control to the highest setting.	Adjust the temperature control to the desired setting.
3	Adjust the air distribution control to the footwell air vents position.	

## Recommended Settings for Heating

	Vehicles With Manual Climate Control	Vehicles With Automatic Climate Control
1	Adjust the fan speed to the second setting.	Press the <b>AUTO</b> button.
2	Adjust the temperature control to the desired setting.	Adjust the temperature control to the desired setting.
3	Adjust the air distribution control to the footwell and windshield air vents position.	



# Climate Control

## Cooling the Interior Quickly

	Vehicles With Manual Climate Control	Vehicles With Automatic Climate Control
1	Adjust the fan speed to the highest setting.	Press the <b>AUTO</b> button.
2	Adjust the temperature control setting to <b>MAX A/C</b> .	Adjust the temperature control to the desired setting.
3	Adjust the air distribution control to the instrument panel air vents position.	Or, press the <b>MAX A/C</b> button.

## Recommended Settings for Cooling

	Vehicles With Manual Climate Control	Vehicles With Automatic Climate Control
1	Adjust the fan speed to the second setting.	Press the <b>AUTO</b> button.
2	Adjust the temperature control to the desired setting.	Adjust the temperature control to the desired setting.
3	Adjust the air distribution control to the instrument panel air vents position.	
4	Press the <b>A/C</b> button.	

## Vehicle Stationary for Extended Periods During Extreme High Ambient Temperatures

	Vehicles With Manual Climate Control	Vehicles With Automatic Climate Control
1	Apply the parking brake.	Apply the parking brake.
2	Move the transmission selector lever to position <b>P</b> or neutral.	Move the transmission selector lever to position <b>P</b> or neutral.
3	Adjust the temperature control to the <b>MAX A/C</b> position.	Press the <b>AUTO</b> button.
4	Adjust the fan speed to the highest setting.	Adjust the temperature control to the desired setting.

# Climate Control

## Side Window Defogging in Cold Weather

	Vehicles With Manual Climate Control	Vehicles With Automatic Climate Control
1	Adjust the fan speed to the highest setting.	Press the MAX defrost button.
2	Adjust the temperature control to the highest setting.	Adjust the temperature control to the desired setting.
3	Adjust the air distribution control to the windshield position.	
4	Press the <b>A/C</b> button.	

### Maximum Cooling Performance in Instrument Panel or Instrument Panel and Footwell Positions

1. Adjust the temperature control to the lowest setting.
2. Press the **A/C** and recirculated air buttons.
3. Adjust the fan speed to the highest setting initially and then adjust it to suit the desired comfort level.

## HEATED WINDOWS AND MIRRORS

### Heated Windows

Use the heated windows to defrost or demist the rear window.

**Note:** The heated windows operate only when the engine is running.

### Heated Rear Window



### Heated Exterior Mirrors

Electric exterior mirrors have a heating element that will defrost or demist the mirror glass. They will switch on automatically when you switch the heated rear window on.

## CABIN AIR FILTER

Your vehicle is equipped with a cabin air filter. It is located behind the center console.

The particulate filtration system reduces the concentration of airborne particles such as dust, spores and pollen in the air supplied to the interior of your vehicle.

**Note:** Make sure you have a cabin air filter installed at all times. This prevents foreign objects from entering the system. Running the system without a filter in place could result in degradation or damage to the system.

# Climate Control

---

The particulate filtration system gives you and your passengers the following benefits:

- It improves your driving comfort by reducing particle concentration.
- It improves the interior compartment cleanliness.
- It protects the climate control components from particle deposits.



Replace the filter at regular intervals. See **Scheduled Maintenance** (page 371).

For additional cabin air filter information, or to replace the filter, see an authorized dealer.

# Seats

## SITTING IN THE CORRECT POSITION

### WARNINGS

-  Do not recline the seatback too far as this can cause the occupant to slide under the safety belt, resulting in serious injury in the event of a collision.
-  Sitting improperly, out of position or with the seatback reclined too far, can result in serious injury or death in the event of a collision. Always sit upright against your seatback, with your feet on the floor.
-  Do not place objects higher than the seatback to reduce the risk of serious injury in the event of a collision or during heavy braking.

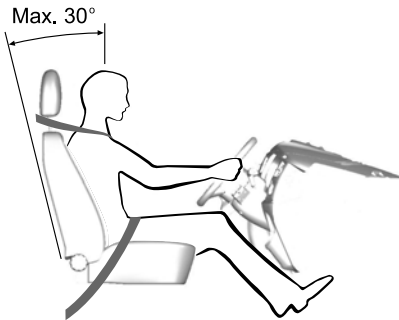

E68595

When you use them properly, the seat, head restraint, safety belt and air bags will provide optimum protection in the event of a collision.

We recommend that you follow these guidelines:



- Sit in an upright position with the base of your spine as far back as possible.
- Do not recline the seatback more than 30 degrees.

- Adjust the head restraint so that the top of it is level with the top of your head and as far forward as possible. Make sure that you remain comfortable.
- Keep sufficient distance between yourself and the steering wheel. We recommend a minimum of 10 inches (25 centimeters) between your breastbone and the air bag cover.
- Hold the steering wheel with your arms slightly bent.
- Bend your legs slightly so that you can press the pedals fully.
- Position the shoulder strap of the safety belt over the center of your shoulder and position the lap strap tightly across your hips.

Make sure that your driving position is comfortable and that you can maintain full control of your vehicle.

## HEAD RESTRAINTS

### WARNINGS

-  Fully adjust the head restraint before you sit in or operate your vehicle. This will help minimize the risk of neck injury in the event of a crash. Do not adjust the head restraint when your vehicle is moving.
-  The head restraint is a safety device. Whenever possible it should be installed and properly adjusted when the seat is occupied. An improperly adjusted head restraint may not adequately protect an occupant during an impact from the rear.
-  Install the head restraint properly to help minimize the risk of neck injury in the event of a crash.

# Seats

**Note:** Adjust the seat back to an upright driving position before adjusting the head restraint. Adjust the head restraint so that the top of it is level with the top of your head and as far forward as possible. Make sure that you remain comfortable. If you are extremely tall, adjust the head restraint to its highest position.

## Front seat head restraint

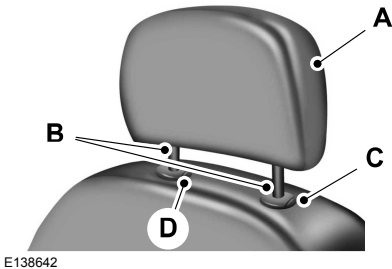

## Rear seat outboard head restraints

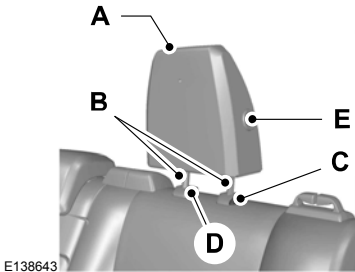

## Rear center and outboard head restraint

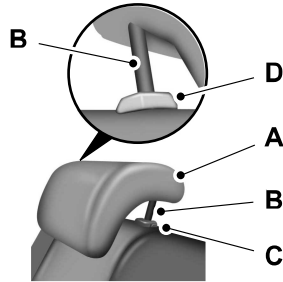

The head restraints consist of:

- A an energy absorbing head restraint
- B two steel stems
- C guide sleeve adjust and unlock button
- D guide sleeve unlock and remove button
- E fold button

## Adjusting the Head Restraint

### Raising the Head Restraint

Pull the head restraint up.

### Lowering the Head Restraint

1. Press and hold button C.
2. Push the head restraint down.

### Removing the Head Restraint

1. Pull the head restraint up until it reaches its highest position.
2. Press and hold buttons C and D.
3. Pull the head restraint up.

# Seats

## Installing the Head Restraint

Align the steel stems into the guide sleeves and push the head restraint down until it locks.

## Folding the Head Restraint

1. Press and hold button E.
2. Pull it back up to reset.

## Tilting Head Restraints (If Equipped)

The front head restraints may have a tilting feature for extra comfort. To tilt the head restraint, do the following:



E144727

1. Adjust the seat back to an upright driving or riding position.
2. Pivot the head restraint forward toward your head to the desired position.

After the head restraint reaches the forward-most tilt position, pivot it forward again to release it to the rearward, un-tilted position.

## MANUAL SEATS

### WARNING

 Do not adjust the driver seat when your vehicle is moving. This may result in the loss of control of your vehicle, serious personal injury or death.

## Moving the Seat Backward and Forward

### WARNING

 Rock the seat backward and forward after releasing the lever to make sure that it is fully engaged in its catch. A seat which is not fully engaged in its catch could move when your vehicle is moving. This may result in the loss of control of your vehicle, serious personal injury or death.

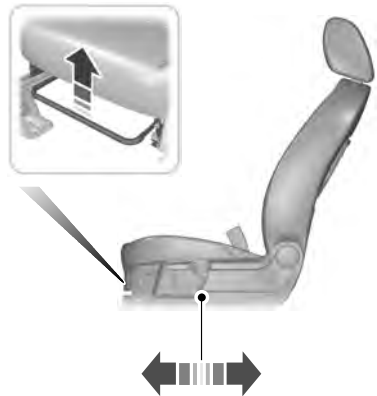

E147926

# Seats

## Adjusting the Lumbar Support (if Equipped)



E142199

## Adjusting the Height of the Driver Seat

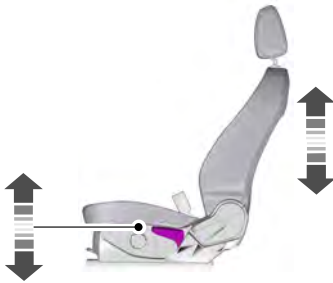

E70730

## Recline Adjustment

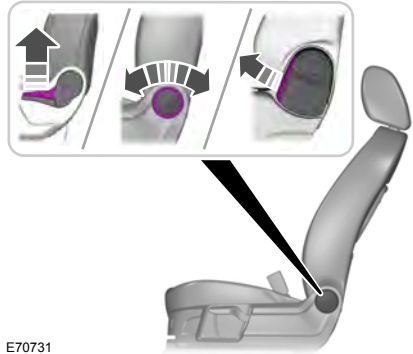

E70731

## REAR SEATS

### Folding the Seatback

#### WARNING



When folding the seatback down, take care not to get your hands caught between the seatback and the frame, catches or mechanism. Failure to take care may result in personal injury.

**Note:** Fully lower the head restraints. Your vehicle may have folding rear head restraints. Fold these before you fold the seatback. See **Head Restraints** (page 105).

# Seats



E156656

1. Press the unlock buttons down and hold them there.
2. Push the seatback forward.

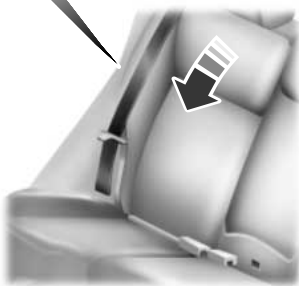

E165362

3. Stow the safety belt in the belt stowage clip. This prevents the safety belt from getting caught in the seat latch.

**Note:** Do not attempt to fold the rear seat cushion forward.

## Unfolding the Seatback

### WARNINGS



When unfolding the seatback up, take care not to get your hands caught between the seatback and the frame, catches or mechanism. Failure to take care may result in personal injury.



Make sure that any cargo or objects are not trapped behind the seatback. Make sure the safety belts are not trapped in any way when unfolding the seatback up. Failure of an occupant to be able to use a trapped safety belt increases the risk of serious personal injury or death.



Make sure that the seatback is fully engaged in its catch. A seatback which is not fully engaged in its catch could move in the event of an accident. This may result in serious personal injury or death.

## HEATED SEATS

### WARNINGS



People who are unable to feel pain to their skin because of advanced age, chronic illness, diabetes, spinal cord injury, medication, alcohol or drug use, exhaustion or other physical conditions, must exercise extreme care when using the heated seat. The heated seat may cause burns even at low temperatures, especially if used for long periods of time. An overheated seat may cause serious personal injury.



# Seats

## WARNINGS



Do not place anything on the seat that insulates against heat, for example; blankets or cushions. This may cause the heated seat to overheat. An overheated seat may cause serious personal injury.



Do not puncture the seat with any sharp objects. This may damage the heating element which may cause the heated seat to overheat. An overheated seat may cause serious personal injury.



Do not place heavy objects on the seat. This may damage the heating element which may cause the heated seat to overheat. An overheated seat may cause serious personal injury.



Do not use the seat heater if any liquid is spilled on the seat. This may damage the heating element which may cause the heated seat to overheat. Allow the seat to dry thoroughly before reusing the seat heater. An overheated seat may cause serious personal injury.

**Note:** *The heated seats include both a heated seat cushion and heated seatback.*



Press the required switch to turn the seat heating on. The lamp inside the switch will illuminate. Press the switch again to turn the seat heating off.

The seat heaters will only turn on with the ignition turned on.

**Note:** *You should avoid using the seat heaters unless the engine is running. Using the seat heaters without the engine running could drain your vehicle battery.*

The heated seat will remain turned on until either the heated seat switch or the ignition is turned off.



E156657

# Auxiliary Power Points

## 12 Volt DC Power Point

### WARNING



Do not plug optional electrical accessories into the cigar lighter socket. Incorrect use of the lighter can cause damage not covered by your warranty, and can result in fire or serious injury.

**Note:** When you switch the ignition on, you can use the socket to power 12 volt appliances with a maximum current rating of 20 amps.

After you switch the ignition off the power supply will only work for a maximum of 30 minutes.

**Note:** Do not insert objects other than an accessory plug into the power point. This will damage the outlet and blow the fuse.

**Note:** Do not hang any type of accessory or accessory bracket from the plug.

**Note:** Do not use the power point over the vehicle capacity of 12 volt DC 180 watt or a fuse may blow.

**Note:** Do not use the power point for operating a cigar lighter element.

**Note:** Incorrect use of the power point can cause damage not covered by your warranty.

**Note:** Always keep the power point caps closed when not in use.

Run the engine for full capacity use of the power point.

To prevent the battery from running out of charge:

- Do not use the power point longer than necessary when the engine is not running.
- Do not leave devices plugged in overnight or when your vehicle is parked for extended periods.

## Location

Power points may be found:

- on the center console
- on the rear of the center console.

## CIGAR LIGHTER (IF EQUIPPED)

**Note:** Do not hold the cigar lighter element pressed in.

**Note:** If you use the socket when the engine is not running, the battery may lose charge.

**Note:** When you switch the ignition on, you can use the socket to power 12 volt appliances with a maximum current rating of 20 amps.

**Note:** After you switch the ignition off the power supply will only work for a maximum of 30 minutes.

**Note:** Use only Ford accessory connectors or connectors specified for use with SAE standard sockets.



E103382

Press the element in to use the cigar lighter. It will pop out automatically.

# Storage Compartments

---

## CUP HOLDERS

### WARNING



Do not place hot drinks in the cup holders when your vehicle is moving.

---

# Starting and Stopping the Engine

## GENERAL INFORMATION

### WARNINGS

 Extended idling at high engine speeds can produce very high temperatures in the engine and exhaust system, creating the risk of fire or other damage.

 Do not park, idle or drive your vehicle on dry grass or other dry ground cover. The emission system heats up the engine compartment and exhaust system, creating the risk of fire.

 Do not start the engine in a closed garage or in other enclosed areas. Exhaust fumes can be toxic. Always open the garage door before you start the engine.

 If you smell exhaust fumes inside your vehicle, have your vehicle checked by an authorized dealer immediately. Do not drive your vehicle if you smell exhaust fumes.

If you disconnect the battery, your vehicle may exhibit some unusual driving characteristics for approximately 5 miles (8 kilometers) after you reconnect it. This is because the engine management system must realign itself with the engine. You can disregard any unusual driving characteristics during this period.

The powertrain control system meets all Canadian interference-causing equipment standard requirements regulating the impulse electrical field or radio noise.

When you start the engine, avoid pressing the accelerator pedal before and during operation. Only use the accelerator pedal when you have difficulty starting the engine.

## IGNITION SWITCH



E72128

**O** (off) - The ignition is off.

**Note:** When you switch the ignition off and leave your vehicle, do not leave your key in the ignition. This could cause your vehicle battery to lose charge.

**Note:** To switch the engine off when your vehicle is moving, move the transmission selector lever to position **N**. Use the brakes to bring the vehicle to a safe stop. After your vehicle has stopped, switch the engine off and move the transmission selector lever to position **P**. Turn the key to position **O** or **I**.

**I** (accessory) - Allows the electrical accessories such as the radio to operate while the engine is not running.

**Note:** Do not leave the ignition key in this position for too long. This could cause your vehicle battery to lose charge.

**II** (on) - All electrical circuits operational. Warning lamps and indicators are illuminated.

**III** (start) - cranks the engine. Release the key as soon as the engine starts.

## KEYLESS STARTING (IF EQUIPPED)

### WARNING



The system may not function if the key is close to metal objects or electronic devices such as cell phones.

# Starting and Stopping the Engine

**Note:** The ignition will automatically switch off when you leave your vehicle unattended. This is to prevent your vehicle battery running out of charge.

**Note:** A valid key must be located inside your vehicle to switch the ignition on and start the engine.

## Ignition On

Press the START button once. It is located on the instrument panel near the steering wheel. All electrical circuits and accessories are operational and the warning lamps and indicators will illuminate.

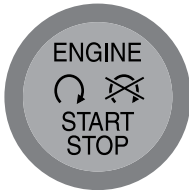

E142555

## Starting with Manual Transmission

**Note:** Releasing the clutch pedal while the engine is starting will stop the engine cranking and return to ignition on.

1. Fully depress the clutch pedal.
2. Briefly press the button.

## Starting with Automatic Transmission

**Note:** Releasing the brake pedal while the engine is starting will stop the engine cranking and return to ignition on.

1. Move the transmission selector lever to position P or N.
2. Fully depress the brake pedal.
3. Briefly press the button.

## Failure to Start

### All Vehicles

The system will not function if:

- The key frequencies are jammed.
- The key battery has no charge.

If you are unable to start your vehicle, do the following.



E99666

1. Hold the key next to the steering column exactly as shown.
2. With the key in this position you can use the button to switch the ignition on and start your engine.

## Manual Transmission

**Note:** Releasing the clutch pedal while the engine is starting will stop the engine cranking and return to ignition on. A message will be shown in the display.

If the engine does not crank when the clutch pedal has been fully depressed and the button is pressed:

1. Fully depress both the clutch and brake pedals.
2. Press the button until the engine starts.

# Starting and Stopping the Engine

## Stopping the Engine with Your Vehicle Stationary

**Note:** The ignition, all electrical circuits warning lamps and indicators will be switched off.

### Manual Transmission

Briefly press the button.

### Automatic Transmission

1. Move the transmission selector lever to position P.
2. Press the button.

## Stopping the Engine When Your Vehicle is Moving

### WARNING



Switching off the engine when the vehicle is still moving will result in a loss of brake and steering assistance. The steering will not lock, but higher effort will be required. With the ignition switched off some electrical circuits, warning lamps and indicators may also be off.

1. Press and hold the button for at least one second or press it three times within two seconds.
2. Move the transmission selector lever to position N and use the brakes to bring your vehicle to a safe stop.
3. When your vehicle has stopped, move the transmission selector lever to position P or N and switch the ignition off.

## STARTING A GASOLINE ENGINE

**Note:** You can only operate the starter for a limited period of time, for example 10 seconds. The number of start attempts is limited to approximately six. If you exceed this limit, the system will not allow you to try again until a period of time has elapsed, for example 30 minutes.

When you start the engine, the idle speed increases, this helps to warm up the engine. If the engine idle speed does not slow down automatically, have your vehicle checked by an authorized dealer.

Before starting the engine check the following:

- Make sure all occupants have fastened their safety belts.
- Make sure the headlamps and electrical accessories are off.
- Make sure the parking brake is on.
- Move the transmission selector lever to position **P** (automatic transmission) or neutral (manual transmission).
- Turn the ignition key to position **II**. If your vehicle is equipped with a keyless ignition, see the following instructions.

## Cold or Hot Engine

### Vehicles with Manual Transmission

**Note:** Do not touch the accelerator pedal.

**Note:** Releasing the clutch pedal while the engine is starting will stop the engine cranking and return to ignition on.

1. Fully depress the clutch pedal.
2. Start the engine.

### Vehicles with Automatic Transmission

**Note:** Do not touch the accelerator pedal.

# Starting and Stopping the Engine

1. Move the transmission selector lever to position **P** or **N**.
2. Start the engine.

## All Vehicles

If the engine does not start within 10 seconds, wait for a short period and try again.

If the engine does not start after three attempts, wait 10 seconds and follow the flooded engine procedure.

If you have difficulty starting the engine when the temperature is below -13°F (-25°C), press the accelerator pedal to the mid-way point of its travel and try again.

## Flooded Engine

### Vehicles with Manual Transmission

1. Fully depress the clutch pedal.
2. Fully depress the accelerator pedal and hold it there.
3. Start the engine.

### Vehicles with Automatic Transmission

1. Move the transmission selector lever to position **P** or **N**.
2. Fully depress the accelerator pedal and hold it there.
3. Start the engine.

## All Vehicles

If the engine does not start, repeat the cold or hot engine procedure.

## Engine Idle Speed after Starting

The speed at which the engine idles immediately after starting is optimized to minimize vehicle emissions and maximize cabin comfort and fuel economy.

The idle speed will vary depending on certain factors. These include vehicle component and ambient temperatures as well as electrical and climate system demands.

## Failure to Start

### Vehicles with Manual Transmission

If the engine does not crank when the clutch pedal has been fully depressed and the ignition key is turned to position **III**.

1. Fully depress the clutch and brake pedals.
2. Turn the key to position **III** until the engine has started.

## SWITCHING OFF THE ENGINE

### Vehicles With a Turbocharger

#### WARNING



Do not switch the engine off when it is running at high speed. If you do, the turbocharger will continue running after the engine oil pressure has dropped to zero. This will lead to premature turbocharger bearing wear.

Release the accelerator pedal. Wait until the engine has reached idle speed and then switch it off.

### ENGINE BLOCK HEATER (IF EQUIPPED)

#### WARNINGS



Failure to follow engine block heater instructions could result in property damage or serious personal injury.

# Starting and Stopping the Engine

## WARNINGS



Do not use your heater with ungrounded electrical systems or two-pronged adapters. There is a risk of electrical shock.

**Note:** *The heater is most effective when outdoor temperatures are below 0°F (-18°C).*

The heater acts as a starting aid by warming the engine coolant. This allows the climate control system to respond quickly. The equipment includes a heater element (installed in the engine block) and a wire harness. You can connect the system to a grounded 120-volt AC electrical source.

We recommend that you do the following for a safe and correct operation:

- Use a 16-gauge outdoor extension cord that is product certified by Underwriter's Laboratory (UL) or Canadian Standards Association (CSA). This extension cord must be suitable for use outdoors, in cold temperatures, and be clearly marked Suitable for Use with Outdoor Appliances. Do not use an indoor extension cord outdoors. This could result in an electric shock or become a fire hazard.
  - Use as short an extension cord as possible.
  - Do not use multiple extension cords.
  - Make sure that when in operation, the extension cord plug and heater cord plug connections are free and clear of water. This could cause an electric shock or fire.
  - Make sure your vehicle is parked in a clean area, clear of combustibles.
  - Make sure the heater, heater cord and extension cord are firmly connected.
- Check for heat anywhere in the electrical hookup once the system has been operating for approximately 30 minutes.
  - Make sure the system is unplugged and properly stowed before driving your vehicle. Make sure the protective cover seals the prongs of the block heater cord plug when not in use.
  - Make sure the heater system is checked for proper operation before winter.

## Using the Engine Block Heater

Make sure the receptacle terminals are clean and dry prior to use. Clean them with a dry cloth if necessary.

The heater uses 0.4 to 1.0 kilowatt-hours of energy per hour of use. The system does not have a thermostat. It achieves maximum temperature after approximately three hours of operation. Using the heater longer than three hours does not improve system performance and unnecessarily uses electricity.



# Fuel and Refueling

---

## SAFETY PRECAUTIONS

### WARNINGS



Do not overfill the fuel tank. The pressure in an overfilled tank may cause leakage and lead to fuel spray and fire.



The fuel system may be under pressure. If you hear a hissing sound near the fuel filler door (Easy Fuel capless fuel system), do not refuel until the sound stops. Otherwise, fuel may spray out, which could cause serious personal injury.



Automotive fuels can cause serious injury or death if misused or mishandled.



The flow of fuel through a fuel pump nozzle can produce static electricity, which can cause a fire if fuel is pumped into an ungrounded fuel container.



Fuel ethanol and gasoline may contain benzene, which is a cancer-causing agent.



When refueling always shut the engine off and never allow sparks or open flames near the filler neck.

Never smoke or use a cell phone while refueling. Fuel vapor is extremely hazardous under certain conditions. Avoid inhaling excess fumes.

---

Observe the following guidelines when handling automotive fuel:

- Extinguish all smoking materials and any open flames before refueling your vehicle.
- Always turn off the vehicle before refueling.
- Automotive fuels can be harmful or fatal if swallowed. Fuel such as gasoline is highly toxic and if swallowed can cause death or permanent injury. If fuel is swallowed, call a physician immediately, even if no symptoms are immediately apparent. The toxic effects of fuel may not be visible for hours.
- Avoid inhaling fuel vapors. Inhaling too much fuel vapor of any kind can lead to eye and respiratory tract irritation. In severe cases, excessive or prolonged breathing of fuel vapor can cause serious illness and permanent injury.
- Avoid getting fuel liquid in your eyes. If fuel is splashed in the eyes, remove contact lenses (if worn), flush with water for 15 minutes and seek medical attention. Failure to seek proper medical attention could lead to permanent injury.
- Fuels can also be harmful if absorbed through the skin. If fuel is splashed on the skin, clothing or both, promptly remove contaminated clothing and wash skin thoroughly with soap and water. Repeated or prolonged skin contact with fuel liquid or vapor causes skin irritation.
- Be particularly careful if you are taking "Antabuse" or other forms of disulfiram for the treatment of alcoholism. Breathing gasoline vapors, or skin contact could cause an adverse reaction. In sensitive individuals, serious personal injury or sickness may result. If fuel is splashed on the skin, promptly wash skin thoroughly with soap and water. Consult a physician immediately if you experience an adverse reaction.

# Fuel and Refueling

## FUEL QUALITY

### Choosing the Right Fuel (Gasoline Vehicles)

Use only unleaded gasoline or unleaded gasoline blended with a maximum of 15% ethanol in your gasoline vehicle.

Do not use:

- Fuels containing more than 15% ethanol or E-85 fuel.
- Fuels containing methanol.
- Fuels containing metallic based additives, including manganese-based compounds.
- Fuels containing the octane booster additive, methylcyclopentadienyl manganese tricarbonyl.
- Leaded fuel. The use of leaded fuel is prohibited by law.

**Note:** *The use of any fuel other than the recommended fuel can cause powertrain damage, impair the emission control system or cause loss of vehicle performance and repairs may not be covered under warranty.*

### Choosing the Right Fuel (Flexible Fuel Vehicles)

Use only unleaded gasoline or unleaded gasoline blended with a maximum of 85% ethanol E-85 in your vehicle. Your vehicle will have a yellow bezel placed over the fuel tank filler pipe.

Do not use:

- Fuels containing more than 85% ethanol or E-100 fuel.
- Fuels containing methanol.
- Fuels containing metallic based additives, including manganese-based compounds.

- Fuels containing the octane booster additive, methylcyclopentadienyl manganese tricarbonyl.
- Leaded fuel. The use of leaded fuel is prohibited by law.

**Note:** *The use of any fuel other than the recommended fuel can cause powertrain damage, impair the emission control system or cause loss of vehicle performance and repairs may not be covered under warranty.*

## Octane Recommendations

### 1.6L Engine

Regular unleaded gasoline with a pump (R+M)/2 octane rating of 87 is recommended. Some fuel stations offer fuels posted as regular with an octane rating below 87, particularly in high altitude areas. Fuels with octane levels below 87 are not recommended.

### 1.0L and 1.6L EcoBoost Engines

Regular unleaded gasoline with a pump (R+M)/2 octane rating of 87 is recommended. Some fuel stations offer fuels posted as regular with an octane rating below 87, particularly in high altitude areas. Fuels with octane levels below 87 are not recommended. Premium fuel will provide improved performance and is recommended for severe duty usage such as trailer tow.

Do not be concerned if your engine sometimes knocks lightly. However, if it knocks heavily while you are using fuel with the recommended octane rating, see an authorized dealer to prevent any engine damage.

## RUNNING OUT OF FUEL

Avoid running out of fuel because this situation may have an adverse effect on powertrain components.

# Fuel and Refueling

If you have run out of fuel:

- You may need to cycle the ignition from off to on several times after refueling to allow the fuel system to pump the fuel from the tank to the engine. On restarting, cranking time will take a few seconds longer than normal. With keyless ignition, just start the engine. Crank time will be longer than usual.
- Normally, adding 1 gallon (4.6 liters) of fuel is enough to restart the engine. If your vehicle is out of fuel and on a steep grade, more than 1 gallon (4.6 liters) may be required.

## Refilling With a Portable Fuel Container

### WARNINGS



Do not insert the nozzle of portable fuel containers or aftermarket funnels into the capless fuel system. This could damage the fuel system and its seal, and may cause fuel to run onto the ground instead of filling the tank, which could result in serious personal injury.



Do not try to pry open or push open the capless fuel system with foreign objects. This could damage the fuel system and its seal and cause injury to you or others.

**Note:** Do not use aftermarket funnels; they will not work with the capless fuel system and can damage it. The included funnel has been specially designed to work safely with your vehicle.

When filling your vehicle's fuel tank from a portable fuel container, use the funnel included with your vehicle.



E142668

1. Locate the plastic funnel in the rear of the vehicle, inside the load compartment.
2. Slowly insert the funnel into the capless fuel system.
3. Fill your vehicle with fuel from the portable fuel container.
4. When done, clean the funnel or properly dispose of it. Extra funnels can be purchased from your authorized dealer if you choose to dispose of the funnel.

## REFUELING

### WARNINGS



Fuel vapor burns violently and a fuel fire can cause severe injuries.



Read and follow all the instructions on the pump island.



Turn off your engine when you are refueling.



Do not smoke if you are near fuel or refueling your vehicle.





Keep sparks, flames and smoking materials away from fuel.



Stay outside your vehicle and do not leave the fuel pump unattended when refueling your vehicle. This is against the law in some places.

# Fuel and Refueling

## WARNINGS

-  Keep children away from the fuel pump; never let children pump fuel.
-  Do not use personal electronic devices while refueling.

Use the following guidelines to avoid electrostatic charge build-up when filling an ungrounded fuel container:

- Place approved fuel container on the ground.
- Do not fill a fuel container while it is in the vehicle (including the cargo area).
- Keep the fuel pump nozzle in contact with the fuel container while filling.
- Do not use a device that would hold the fuel pump handle in the fill position.

## Easy Fuel™ Capless Fuel System

### WARNING

 The fuel system may be under pressure. If you hear a hissing sound near the fuel filler door, do not refuel until the sound stops. Otherwise, fuel may spray out, which could cause serious personal injury.

When fueling your vehicle:

1. Put the vehicle in **P** (Park) and turn the ignition off.
2. Open the fuel filler door.

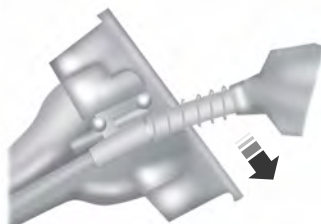

E156032

3. Slowly insert the fuel filler nozzle fully into the fuel system, and leave the nozzle fully inserted to open both doors until you are done pumping. Hold handle higher during insertion for easier access.

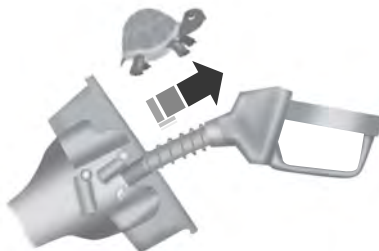

E154765

4. After you are done pumping fuel, slowly remove the fuel filler nozzle—allow about five to ten seconds after pumping fuel before removing the fuel filler nozzle. This allows residual fuel to drain back into the fuel tank and not spill onto the vehicle.

**Note:** A fuel spillage concern may occur if overfilling the fuel tank. Do not overfill the tank to the point that the fuel is able to bypass the fuel filler nozzle. The overfilled fuel may run down the drain located below and in front of the fuel filler door.

# Fuel and Refueling

---

If the fuel fill inlet was not properly closed, a service engine warning lamp may appear on the instrument cluster.

At the next opportunity, do the following:

1. Safely pull off the road.
2. Put the vehicle in **P** (Park) and turn the ignition off.
3. Open the fuel filler door and remove any visible debris from the fuel fill opening.
4. Insert either the fuel fill nozzle or the fuel fill funnel provided with the vehicle several times to allow the inlet to close properly. This will dislodge any debris preventing the inlet from sealing.

If this action corrects the problem, the warning lamp may not reset immediately. It may take several driving cycles for the warning lamp to turn off. A driving cycle consists of an engine start-up (after four or more hours with the engine off) followed by city or highway driving.

## FUEL CONSUMPTION

**Note:** *The amount of usable fuel in the empty reserve varies and should not be relied upon to increase driving range. When refueling your vehicle after the fuel gauge indicates empty, you might not be able to refuel the full amount of the advertised capacity of the fuel tank due to the empty reserve still present in the tank.*

Empty reserve is the amount of fuel remaining in the tank after the fuel gauge indicates empty. Do not rely on this fuel for driving. The usable capacity of the fuel tank is the amount of fuel that can be put into the tank after the gauge indicates empty. The advertised capacity is the total fuel tank size – it is the combined usable capacity plus the empty reserve.

## Filling the Tank

For consistent results when filling the fuel tank:

- Turn the ignition off before fueling; an inaccurate reading results if the engine is left running.
- Use the same fill rate (low-medium-high) each time the tank is filled.
- Allow no more than two automatic click-offs when filling.

Results are most accurate when the filling method is consistent.

## Calculating Fuel Economy

Do not measure fuel economy during the first 1000 miles (1600 kilometers) of driving (this is your engine's break-in period); a more accurate measurement is obtained after 2000 miles – 3000 miles (3200 kilometers – 4800 kilometers). Also, fuel expense, frequency of fill ups or fuel gauge readings are not accurate ways to measure fuel economy.

1. Fill the fuel tank completely and record the initial odometer reading.
2. Each time you fill the tank, record the amount of fuel added.
3. After at least three to five tank fill ups, fill the fuel tank and record the current odometer reading.
4. Subtract your initial odometer reading from the current odometer reading.
5. Calculate fuel economy by dividing miles traveled by gallons used (For Metric: Multiply liters used by 100, then divide by kilometers traveled).

# Fuel and Refueling

Keep a record for at least one month and record the type of driving (city or highway). This provides an accurate estimate of the vehicle's fuel economy under current driving conditions. Additionally, keeping records during summer and winter show how temperature impacts fuel economy. In general, lower temperatures mean lower fuel economy.

## EMISSION CONTROL SYSTEM

### WARNINGS



Do not park, idle, or drive your vehicle in dry grass or other dry ground cover.

The emission system heats up the engine compartment and exhaust system, which can start a fire.



Exhaust leaks may result in entry of harmful and potentially lethal fumes into the passenger compartment. If

you smell exhaust fumes inside your vehicle, have your dealer inspect your vehicle immediately. Do not drive if you smell exhaust fumes.

Your vehicle is equipped with various emission control components and a catalytic converter that will enable your vehicle to comply with applicable exhaust emission standards. To make sure that the catalytic converter and other emission control components continue to work properly:

- Use only the specified fuel listed.
- Avoid running out of fuel.
- Do not turn off the ignition while your vehicle is moving, especially at high speeds.
- Have the items listed in scheduled maintenance information performed according to the specified schedule.

The scheduled maintenance items listed in scheduled maintenance information are essential to the life and performance of your vehicle and to its emissions system.

If you use parts other than Ford, Motorcraft or Ford-authorized parts for maintenance replacements, or for service of components affecting emission control, such non-Ford parts should be the equivalent to genuine Ford Motor Company parts in performance and durability.

Illumination of the service engine soon indicator, charging system warning light or the temperature warning light, fluid leaks, strange odors, smoke or loss of engine power could indicate that the emission control system is not working properly.

An improperly operating or damaged exhaust system may allow exhaust to enter the vehicle. Have a damaged or improperly operating exhaust system inspected and repaired immediately.

Do not make any unauthorized changes to your vehicle or engine. By law, vehicle owners and anyone who manufactures, repairs, services, sells, leases, trades vehicles, or supervises a fleet of vehicles are not permitted to intentionally remove an emission control device or prevent it from working. Information about your vehicle's emission system is on the Vehicle Emission Control Information Decal located on or near the engine. This decal also lists engine displacement

Please consult your warranty information for complete details.

# Fuel and Refueling

## On-Board Diagnostics (OBD-II)

Your vehicle is equipped with an on-board diagnostics system (OBD-II) that monitors the engine's emission control system. This system protects the environment by ensuring that your vehicle continues to meet government emission standards. The OBD-II system also assists your authorized dealer in properly servicing your vehicle.



When the service engine soon indicator illuminates, the OBD-II system has detected a malfunction. Temporary malfunctions may cause the service engine soon indicator to illuminate.

Examples of temporary malfunctions are:

- the vehicle has run out of fuel—the engine may misfire or run poorly
- poor fuel quality or water in the fuel—the engine may misfire or run poorly
- the fuel fill inlet may not have been properly closed See **Refueling** (page 120).
- driving through deep water—the electrical system may be wet.

You can correct these temporary malfunctions by filling the fuel tank with good quality fuel, properly closing the fuel fill inlet or letting the electrical system dry out. After three driving cycles without these or any other temporary malfunctions present, the service engine soon indicator should stay off the next time you start the engine. A driving cycle consists of a cold engine startup followed by mixed city/highway driving. No additional vehicle service is required.

If the service engine soon indicator remains on, have your vehicle serviced at the first available opportunity. Although some malfunctions detected by the OBD-II may not have symptoms that are apparent, continued driving with the service engine soon indicator on can result in increased emissions, lower fuel economy, reduced engine and transmission smoothness, and lead to more costly repairs.

## Readiness for Inspection/Maintenance (I/M) Testing

Some state/provincial and local governments may have Inspection/Maintenance (I/M) programs to inspect the emission control equipment on your vehicle. Failure to pass this inspection could prevent you from getting a vehicle registration.



If the service engine soon indicator is on or the bulb does not work, you may need to have the vehicle serviced. See On-Board Diagnostics (OBD-II).

Your vehicle may not pass the I/M test if the service engine soon indicator is on or not working properly (bulb is burned out), or if the OBD-II system has determined that some of the emission control systems have not been properly checked. In this case, your vehicle is not ready for I/M testing.

If the vehicle's engine or transmission has just been serviced, or the battery has recently run down or been replaced, the OBD-II system may indicate that the vehicle is not ready for I/M testing. To determine if the vehicle is ready for I/M testing, turn the ignition key to the on position for 15 seconds without cranking

# Fuel and Refueling

---

the engine. If the service engine soon indicator blinks eight times, it means that the vehicle is not ready for I/M testing; if the service engine soon indicator stays on solid, it means that the vehicle is ready for I/M testing.

The OBD-II system monitors the emission control system during normal driving. A complete check may take several days. If the vehicle is not ready for I/M testing, you may need to perform the following driving cycle consisting of mixed city and highway driving:

Drive on an expressway or highway for a steady 15 minutes, followed by 20 minutes of stop-and-go driving with at least four 30-second idle periods.

Allow the vehicle to sit for at least eight hours without starting the engine. Then, start the engine and complete the above driving cycle. The engine must warm up to its normal operating temperature. Once started, do not turn off the engine until the above driving cycle is complete. If the vehicle is still not ready for I/M testing, you will have to repeat the above driving cycle.



# Transmission

## MANUAL TRANSMISSION

### Using the Clutch

**Note:** Failure to fully depress the clutch pedal to the floor may cause increased shift efforts, prematurely wear transmission components or damage the transmission.

**Note:** Do not drive with your foot resting on the clutch pedal or use the clutch pedal to hold your vehicle at a standstill while waiting on a hill. These actions will reduce the life of the clutch and could nullify a clutch warranty claim.

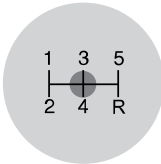

E157512

Manual transmission vehicles have a starter interlock that prevents cranking the engine unless the clutch pedal is fully depressed.

### Starting Your Vehicle

#### WARNING



Make sure the floor mat is positioned correctly so that it does not interfere with the full extension of the clutch pedal.

1. Make sure the parking brake is fully set and move the transmission selector lever to the neutral position.
2. Fully depress the clutch pedal then start the engine.

3. Press the brake pedal and move the transmission selector lever to first or reverse gear.
4. Release the parking brake and slowly release the clutch pedal while slowly pressing on the accelerator.

During each shift, make sure you fully depress the clutch pedal.

### Recommended Shift Speeds

**Note:** Do not move the transmission selector lever to first gear when your vehicle is moving faster than 15 mph (24 km/h). This will damage the clutch.

We recommend you change gear according to the following guide to achieve the best fuel economy for your vehicle.

Shift from	Recommended speed
1 - 2	15 mph (24 km/h)
2 - 3	24 mph (38 km/h)
3 - 4	32 mph (51 km/h)
4 - 5	43 mph (70 km/h)

### Reverse

**Note:** Do not move the transmission selector lever to reverse gear when your vehicle is moving. This can cause damage to the transmission.

1. Fully depress the clutch pedal to disengage clutch.
2. Move the transmission selector lever to the neutral position and wait at least three seconds before moving it to reverse.

# Transmission

If reverse gear is not fully engaged, press the clutch pedal down and move the transmission selector lever to the neutral position. Release the clutch pedal for a moment, depress the clutch again and then move the transmission selector lever to reverse.

## Parking Your Vehicle

### WARNING



Do not park your vehicle with the transmission selector lever in the neutral position. Your vehicle may move unexpectedly and injure someone. Move the transmission selector lever to first gear and set the parking brake fully.

To park your vehicle:

1. Press the brake pedal and move the transmission selector lever to the neutral position.
2. Fully apply the parking brake, hold the clutch pedal down, then move the transmission selector lever to first gear.
3. Switch the ignition off.

## MANUAL TRANSMISSION - 1.6L ECOBOOST™

### Using the Clutch

**Note:** Failure to fully depress the clutch pedal to the floor may cause increased shift efforts, prematurely wear transmission components or damage the transmission.

**Note:** Do not drive with your foot resting on the clutch pedal or use the clutch pedal to hold your vehicle at a standstill while waiting on a hill. These actions will reduce the life of the clutch and could nullify a clutch warranty claim.

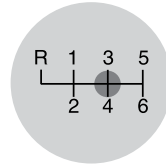

E144954

Manual transmission vehicles have a starter interlock that prevents cranking the engine unless the clutch pedal is fully depressed.

## Starting Your Vehicle

### WARNING



Make sure the floor mat is positioned correctly so that it does not interfere with the full extension of the clutch pedal.

1. Make sure the parking brake is fully set and move the transmission selector lever to the neutral position.
2. Fully depress the clutch pedal then start the engine.
3. Press the brake pedal and move the transmission selector lever to first or reverse gear.
4. Release the parking brake and slowly release the clutch pedal while slowly pressing on the accelerator.

During each shift, make sure you fully depress the clutch pedal.

## Recommended Shift Speeds

**Note:** Do not move the transmission selector lever to first gear when your vehicle is moving faster than 15 mph (24 km/h). This will damage the clutch.

# Transmission

We recommend you change gears according to the following guide to achieve the best fuel economy for your vehicle.

Shift from	Recommended speed
1 - 2	12 mph (19 km/h)
2 - 3	23 mph (37 km/h)
3 - 4	32 mph (51 km/h)
4 - 5	41 mph (66 km/h)
5 - 6	42 mph (67 km/h)

## Reverse

**Note:** Do not move the transmission selector lever to reverse gear when your vehicle is moving. This can cause damage to the transmission.

1. Fully depress the clutch pedal to disengage the clutch.
2. Move the transmission selector lever to the neutral position and wait at least three seconds before moving it to reverse.
3. Raise the collar below the transmission selector lever to select reverse gear.

**Note:** This is a lockout feature which protects the transmission from accidentally engaging reverse gear when intending to select first gear.

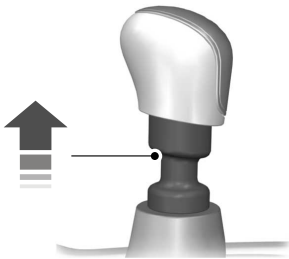

E99067

If reverse gear is not fully engaged, press the clutch pedal down and move the transmission selector lever to the neutral position. Release the clutch pedal for a moment, then raise the collar and move the transmission selector lever to reverse again.

## Parking Your Vehicle

### WARNING

 Do not park your vehicle with the transmission selector lever in the neutral position. Your vehicle may move unexpectedly and injure someone. Move the transmission selector lever to first gear and set the parking brake fully.

To park your vehicle:

1. Press the brake pedal and move the transmission selector lever to the neutral position.
2. Fully apply the parking brake, hold the clutch pedal down, then move the transmission selector lever to first gear.
3. Switch the ignition off.

## AUTOMATIC TRANSMISSION

### WARNINGS

 Always set the parking brake fully and make sure the gearshift is latched in **P** (Park). Turn the ignition to the off position and remove the key whenever you leave your vehicle.

 Do not apply the brake and accelerator pedals simultaneously for more than three seconds as this limits engine rpm and labors the transmission. This may result in difficulty maintaining speed in traffic and could lead to serious injury.

# Transmission

**Note:** When you switch the ignition off, the transmission will carry out a series of checks. You may hear slight clicking sounds. This is normal.

We have designed your vehicle to improve fuel economy by reducing fuel usage compared to a traditional torque converter automatic transmission. When you take your foot off the accelerator pedal and your vehicle begins to slow down, this can feel like a light to medium braking sensation.

## Selector Lever Positions

### WARNING

 You must press the brake pedal to apply the brakes before moving the transmission selector lever. Failure to keep the brakes applied until you are ready to move off may lead to an accident or injury.



E161746

- P Park
- R Reverse
- N Neutral
- D Drive
- S Sport mode or manual shifting

- + Manual shift up
- Manual shift down

Press the button on the front of the transmission selector lever to change to each position.

The transmission selector lever position will be shown in the information display.

## P (Park)

### WARNINGS

 You must only select **P** when your vehicle is stationary. Selecting **P** when your vehicle is moving will damage the transmission and may lead to an accident or injury.

 You must move the transmission selector lever to position **P** and fully apply the parking brake before you leave your vehicle. Failure to leave your vehicle securely parked may lead to an accident or injury.

Your vehicle will not move while the transmission selector lever is in **P**. You can start the engine with the transmission selector lever in this position.

**Note:** An audible warning will sound if you open the driver's door and you have not moved the transmission selector lever to park.

## R (Reverse)

### WARNING

 You must only select **R** when your vehicle is stationary and the engine is at idle speed. Selecting **R** when your vehicle is moving or at a high engine speed will damage the transmission or lead to an accident or injury.

# Transmission

With the transmission selector lever in **R**, power is transmitted to the drive wheels to allow your vehicle to move backward. You cannot start the engine with the transmission selector lever in this position.

**Note:** *Always come to a complete stop before shifting the transmission selector lever out of reverse.*

## N (Neutral)

With the transmission selector lever in **N**, power is not transmitted to the drive wheels and the transmission is not locked, it is possible your vehicle will move if the brakes are not applied. You can start the engine with the transmission selector lever in this position.

## D (Drive)

With the transmission selector lever in **D**, your vehicle will shift automatically through the forward gears. You cannot start the engine with the transmission selector lever in this position.

The transmission will select the appropriate gear for optimum vehicle performance and economy based on ambient temperature, road gradient, vehicle load, speed and your driving style.

When you use Drive mode it provides a downshift function. See **Downshift** in this section.

**Note:** *A shift will occur only when your vehicle and engine speeds are appropriate.*

## Sport Mode and Manual Shifting

### Sport Mode

With the transmission selector lever in **S**, gears are selected quicker and at higher engine speeds. You cannot start the engine with the transmission selector lever in this position.

Sport mode will remain on until you either shift manually up or down the gears using the **+** or **-** buttons on the side of the transmission selector lever or you move the transmission selector lever to drive.

When you use Sport mode it provides a downshift function. See **Downshift** in this section.

### Manual Shifting

#### WARNING



Do not permanently hold the **+** or **-** buttons in. This may damage the transmission and may lead to an accident or injury.

Press the **+** button to shift up and the **-** button to shift down.

Gears may be skipped by pressing the **+** or **-** buttons repeatedly at short intervals.

We recommend you upshift according to the following guide to achieve the best fuel economy for your vehicle.

Shift From	Recommended Speed
1 - 2	15 mph (24 km/h)
2 - 3	25 mph (40 km/h)
3 - 4	40 mph (64 km/h)
4 - 5	45 mph (72 km/h)
5 - 6	50 mph (80 km/h)

Manual mode also provides a downshift function. See **Downshift** in this section.

**Note:** *The transmission will automatically upshift if the engine speed is too high or downshift if the engine speed is too low.*

# Transmission

## Hints on Driving with an Automatic Transmission

### WARNINGS



Do not apply the brake and accelerator pedals simultaneously for more than three seconds as this limits engine rpm and labors the transmission. This may make it difficult to maintain speeds in traffic and lead to an accident or injury.



Do not idle the engine for long periods of time in **D** with the brakes applied. This could damage the transmission and may lead to an accident or injury.

**Note:** The system carries out a series of checks when you switch the ignition on and off. You may hear clicking sounds. This is normal.

### Moving off

1. Press the brake pedal to apply the brakes.
2. Move the transmission selector lever to **R**, **D** or **S**.
3. Release the parking brake.
4. Release the brake pedal and press the accelerator pedal.

### Stopping

1. Release the accelerator pedal and press the brake pedal.
2. Apply the parking brake.
3. Move the transmission selector lever to **N** or **P**.

## Downshift

Press the accelerator pedal fully with the transmission selector lever in either **D**, **S** mode or manual shifting position to select a lower gear for optimum performance. Release the accelerator pedal when you no longer require downshift.

### If Your Vehicle Gets Stuck In Mud or Snow

If your vehicle gets stuck in mud or snow, it may be rocked out by shifting between **D** and **R**, stopping between shifts in a steady pattern. Press the accelerator lightly in each gear.

**Note:** Do not rock your vehicle if the engine is not at normal operating temperature as this can damage the transmission.

**Note:** Do not rock your vehicle for more than a minute as this can damage the transmission or the tires and the engine may overheat.

## Emergency Park Position Release Lever

### WARNINGS



Do not drive your vehicle until you verify that the brake lamps are working. Failure to adhere to warning indicators may lead to an accident or injury.







If you release the parking brake and the brake warning lamp remains illuminated the brakes may not be working correctly. Have your vehicle checked by an authorized dealer as soon as possible. Failure to adhere to warning lamps and indicators may lead to an accident or injury.

Use the emergency **P** position release lever to move the transmission selector lever from the **P** position in the event of a malfunction or if your vehicle battery has no charge.

# Transmission

## HILL START ASSIST (IF EQUIPPED)

### WARNINGS

-  The system does not replace the parking brake. When you leave your vehicle, always apply the parking brake and move the transmission selector lever into position **P** (Park).
-  You must remain in your vehicle once you have activated the system.
-  During all times, you are responsible for controlling your vehicle, supervising the system and intervening, if required.
-  If the engine is revved excessively, or if a malfunction is detected, the system will be deactivated.

The system makes it easier to pull away when your vehicle is on a slope without the need to use the parking brake.

When the system is active, your vehicle will remain stationary on the slope for two to three seconds after you release the brake pedal. This allows you time to move your foot from the brake to the accelerator pedal. The brakes are released automatically once the engine has developed sufficient drive to prevent your vehicle from rolling down the slope. This is an advantage when pulling away on a slope, (for example from a car park ramp, traffic lights or when reversing uphill into a parking space).

The system will activate automatically on any slope which can result in significant vehicle rollback.

### Using Hill Start Assist

1. Press the brake pedal to bring your vehicle to a complete standstill. Keep the brake pedal pressed.

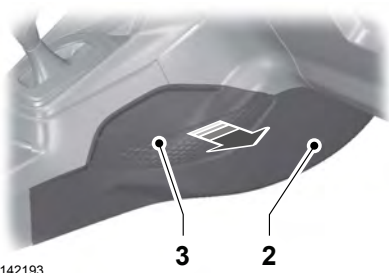

E142193

1. Apply the parking brake and switch the ignition off before carrying out this procedure.
2. Remove the retaining screw.
3. Remove the center console side panel.

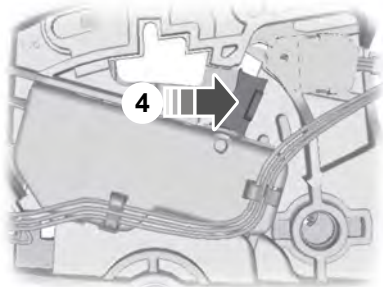

E142214

4. Press the brake pedal. Using a suitable tool rotate the lever forward while pulling the transmission selector lever out of the **P** position.

**Note:** The emergency **P** position release lever is pink.

**Note:** See an authorized dealer as soon as possible if you use procedure.

# Transmission

---

2. If the sensors detect that your vehicle is on a slope, the system will be activated automatically.
3. When you remove your foot from the brake pedal, your vehicle will remain on the slope without rolling away for approximately two or three seconds. This hold time will automatically be extended if you are in the process of driving off.
4. Drive off in the normal manner. The brakes will be released automatically.

## Switching the System On and Off

**Note:** *The system can only be switched on and off for manual transmissions.*

**Note:** *Once you have switched off the system, it will remain off until you switch it on again.*

Your vehicle comes with the system already enabled. If desired, you can disable the feature: See **General Information** (page 85).



# Brakes

## GENERAL INFORMATION

### WARNING



The system does not relieve you of your responsibility to drive with due care and attention.

**Note:** Occasional brake noise is normal. If a metal-to-metal, continuous grinding or continuous squeal sound is present, the brake linings may be worn-out. If the vehicle has continuous vibration or shudder in the steering wheel while braking, have your vehicle checked by an authorized dealer.

**Note:** Brake dust may accumulate on the wheels, even under normal driving conditions. Some dust is inevitable as the brakes wear. See **Cleaning the Alloy Wheels** (page 208).

Wet brakes result in reduced braking efficiency. Gently press the brake pedal a few times when driving from a car wash or standing water to dry the brakes.

### Emergency Brake Assist

Emergency brake assist detects when you brake heavily by measuring the rate at which you press the brake pedal. It provides maximum braking efficiency as long as you press the pedal. Emergency brake assist can reduce stopping distances in critical situations.

### Anti-lock Brake System

This system helps you maintain steering control and vehicle stability during emergency stops by keeping the brakes from locking.

## HINTS ON DRIVING WITH ANTI-LOCK BRAKES

**Note:** When the system is operating, the brake pedal will pulse and may travel further. Maintain pressure on the brake pedal. You may also hear a noise from the system. This is normal.

The anti-lock braking system will not eliminate the risks when:

- you drive too closely to the vehicle in front of you
- your vehicle is hydroplaning
- you take corners too fast
- the road surface is poor.

## PARKING BRAKE

### Vehicles With Automatic Transmission

#### WARNING



Always set the parking brake fully and leave your vehicle with the transmission selector lever in position P.

**Note:** If you park your vehicle on a hill and facing uphill move the transmission selector lever to position P and turn the steering wheel away from the curb.

**Note:** If you park your vehicle on a hill and facing downhill move the transmission selector lever to position P and turn the steering wheel toward the curb.

### Vehicles With Manual Transmission

**Note:** If you park your vehicle on a hill and facing uphill select first gear and turn the steering wheel away from the curb.

# Brakes

---

**Note:** *If you park your vehicle on a hill and facing downhill select reverse gear and turn the steering wheel toward the curb.*

## All Vehicles

**Note:** *Do not press the release button while pulling the lever up.*

To apply the parking brake:

1. Press the foot brake pedal firmly.
2. Pull the parking brake lever up to its fullest extent.

To release the parking brake:

1. Press the brake pedal firmly.
2. Pull the lever up slightly.
3. Press the release button and push the lever down.

# Stability Control (If Equipped)

## PRINCIPLE OF OPERATION

### Electronic Stability Program

#### WARNINGS



The system does not relieve you of your responsibility to drive with due care and attention. Failure to drive with due care and attention could lead to loss of vehicle control.



Vehicle modifications involving braking system, aftermarket roof racks, suspension, steering system, tire construction and wheel and tire size may change the handling characteristics of the vehicle and may adversely affect the performance of the AdvanceTrac system. In addition, installing any stereo loudspeakers may interfere with and adversely affect the AdvanceTrac system. Install any aftermarket stereo loudspeaker as far as possible from the front center console, the tunnel, and the front seats in order to minimize the risk of interfering with the AdvanceTrac sensors. Reducing the effectiveness of the AdvanceTrac system could lead to an increased risk of loss of vehicle control, vehicle rollover, personal injury and death.



Remember that even advanced technology cannot defy the laws of physics. It's always possible to lose control of a vehicle due to inappropriate driver input for the conditions. Aggressive driving on any road condition can cause you to lose control of your vehicle increasing the risk of personal injury or property damage. Activation of the AdvanceTrac system is an indication that at least some of the tires have exceeded their ability to grip the road; this could reduce the operator's ability to control the vehicle potentially resulting in a loss of vehicle control, vehicle rollover, personal injury and death. If your AdvanceTrac system activates, SLOW DOWN.

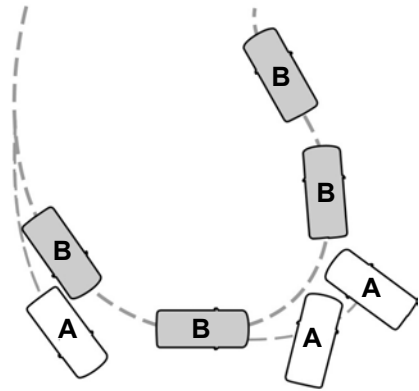

E72903

- A Without Advance Trac
- B With Advance Trac

The system supports stability when your vehicle starts to slide away from your intended path. This is performed by braking individual wheels and reducing engine torque as needed.

The system also provides an enhanced traction control function by reducing engine torque if the wheels spin when you accelerate. This improves your ability to pull away on slippery roads or loose surfaces, and improves comfort by limiting wheel spin in hairpin bends.

### Stability Control Warning Lamp

While driving, it flashes when the system is operating. See **Warning Lamps and Indicators** (page 78).

# Stability Control (If Equipped)

## USING STABILITY CONTROL

**Note:** *The system automatically switches on every time you switch the ignition on.*

You can switch the system on and off using the information display. See **General Information** (page 85).

## USING STABILITY CONTROL - 1.6L ECOBOOST™



E156922

**Note:** *The system will switch on automatically every time you switch the ignition on.*

**Note:** *You can also switch the system off and on using the information display. See **Information Displays** (page 85).*

## Switching Sport Mode On

Press the switch. It will illuminate and a message will be displayed in the information display. Press the switch again to return the system to normal mode.

**Note:** *In this mode stability control is only reduced and not switched off completely.*

## Switching the System Off

Press and hold the switch for approximately five seconds. It will illuminate and a message will be displayed in the information display. Press the switch again to return the system to normal mode.

# Parking Aids (If Equipped)

## PRINCIPLE OF OPERATION

### WARNINGS



The system does not relieve you of your responsibility to drive with due care and attention.



If your vehicle has a non-Ford approved trailer tow module the system may not correctly detect objects.



The sensors may not detect objects in heavy rain or other conditions that cause disruptive reflections.



The sensors may not detect objects with surfaces that absorb ultrasonic waves.



The system does not detect objects that are moving away from your vehicle. They will only be detected shortly after they start to move toward your vehicle.



Take particular care when reversing with a tow ball arm or a rear fitted accessory. For example, a bicycle carrier. The rear parking aid will only indicate the approximate distance from the rear bumper to an object.



If you use a high pressure spray to wash your vehicle, only spray the sensors briefly from a distance not less than eight inches (20 centimeters).

**Note:** If your vehicle has a tow ball arm, the system is turned off automatically when trailer lamps (or lighting boards) are connected to the 13-pin socket through a Ford approved trailer tow module.

**Note:** Keep the sensors free from dirt, ice or snow. Do not clean with sharp objects.

**Note:** The system may emit false alerts if it detects a signal using the same frequency as the sensors or if your vehicle is fully loaded.

**Note:** The outer sensors may detect the side walls of a garage. If the distance between the outer sensors and the side wall remains constant for three seconds, the alert will turn off. As you continue the inner sensors will detect objects directly behind your vehicle.

## PARKING AID

### WARNINGS



To help avoid personal injury, read and understand the limitations of the system as contained in this section. Sensing is only an aid for some (generally large and fixed) objects when moving in reverse on a flat surface at parking speeds. Traffic control systems, inclement weather, air brakes and external motors and fans may also affect the function of the sensing system. This may include reduced performance or a false activation.



To help avoid personal injury, always use caution when moving in reverse and when using the sensing system.



This system is not designed to prevent contact with small or moving objects. The system is designed to provide a warning to assist the driver in detecting large stationary objects to avoid damaging the vehicle. The system may not detect smaller objects, particularly those close to the ground.



Certain add-on devices such as large trailer hitches, bike or surfboard racks and any device that may block the normal detection zone of the system, may create false audible warnings.

**Note:** Keep the sensors located on the bumper or fascia free from snow, ice and large accumulations of dirt. If the sensors are covered, the system's accuracy can be affected. Do not clean the sensors with sharp objects.

## Parking Aids (If Equipped)

**Note:** If your vehicle sustains damage to the bumper or fascia, leaving it misaligned or bent, the sensing zone may be altered causing inaccurate measurement of obstacles or false alarms.

The system warns you of obstacles within a certain range of the bumper area.

When receiving a detection warning, the radio volume is reduced to a predetermined level. After the warning goes away, the radio volume returns to the previous level.

### Rear Sensing System

The rear sensors are only active when you move the transmission selector lever to position **R** (reverse). As your vehicle moves closer to the obstacle, the rate of the audible warning increases. When the obstacle is fewer than 12 inches (30 centimeters) away, the audible warning sounds continuously. If a stationary or receding object is detected farther than 12 inches (30 centimeters) from the side of your vehicle, the audible warning sounds for only three seconds. Once the system detects an object approaching, the audible warning sounds again.

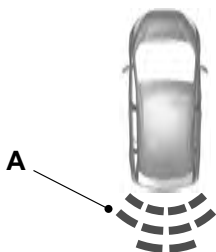

E130178

- A Coverage area of up to 72 inches (183 centimeters) from the rear bumper (with a decreased coverage area at the outer corners of the bumper).

The system detects certain objects when you move the transmission selector lever to position **R** (reverse):

- and your vehicle is moving toward a stationary object at a speed of 3 mph (5 km/h) or less
- but your vehicle is not moving, and a moving object is approaching the rear of your vehicle at a speed of 3 mph (5 km/h) or less
- and your vehicle is moving at a speed of less than 3 mph (5 km/h) and a moving object is approaching the rear of your vehicle at a speed of less than 3 mph (5 km/h).

Move the transmission selector lever from position **R** (reverse) to turn the system off. If a fault is present in the system, a warning message appears in the information display and does not allow you to switch the system on.

### REAR VIEW CAMERA (IF EQUIPPED)

#### WARNINGS



The operation of the camera may vary depending on the ambient temperature, vehicle and road conditions.



The distances shown in the display may differ from the actual distance.



Do not place objects in front of the camera.

The camera is located on the liftgate near the handle.

## Parking Aids (If Equipped)



E147796

### Switching the Rear View Camera On

#### WARNING



The camera may not detect objects that are close to your vehicle.

Switch the ignition and the audio unit on.  
Move the transmission selector lever to position **R** (reverse).

The image is displayed on the screen.

The camera may not operate correctly in the following conditions:

- Dark areas.
- Intense light.
- If the ambient temperature increases or decreases rapidly.
- If the camera is wet, for example in rain or high humidity.
- If the camera's view is obstructed, for example by mud.

### Using the Display

#### WARNINGS



Obstacles above the camera position will not be shown. Inspect the area behind your vehicle if necessary.



Marks are for general guidance only, and are calculated for vehicles in maximum load conditions on an even road surface.

The lines show the distance from the outer edge of the front tire plus two inches (51 millimeters) and the rear bumper.

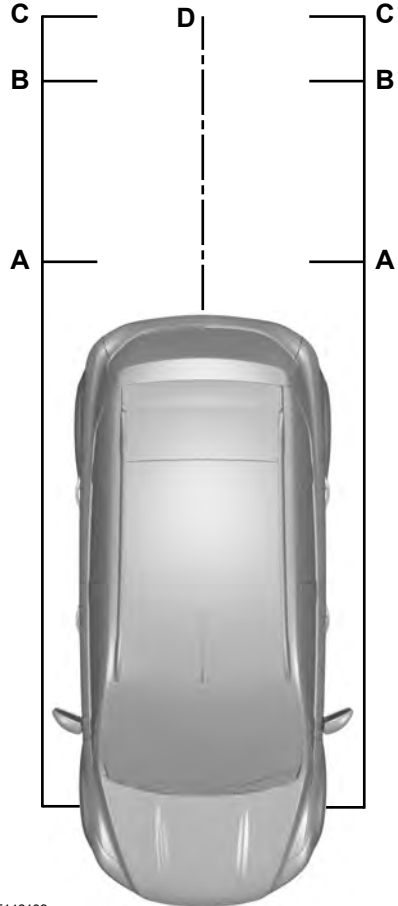

E142132

- A Red - Zone
- B Amber - Zone

## Parking Aids (If Equipped)

---

- C Green - Zone
- D Black - center line of the projected vehicle path

**Note:** *When reversing with a trailer, the lines on the screen are not shown. The camera will show your vehicle direction and not the trailer.*

### **Switching the Rear View Camera Off**

**Note:** *The system will automatically switch off once your vehicle speed has reached approximately 6 mph (10 km/h).*

Disengage reverse gear.

### **Vehicles with Parking Aid**

The display will additionally show a colored distance bar. This guide indicates the distance from the rear bumper to the detected obstacle.

These are color coded as follows:

- Green - Zone
- Amber - Zone
- Red - Zone



# Cruise Control (If Equipped)

## PRINCIPLE OF OPERATION

### WARNING



The system does not relieve you of your responsibility to drive with due care and attention.

Cruise control allows you to control your speed using the switches on the steering wheel. You can use cruise control when you exceed approximately 20 mph (30 km/h).

## USING CRUISE CONTROL

### WARNINGS



Do not use cruise control in heavy traffic, on winding roads or when the road surface is slippery. This could result in loss of vehicle control, serious injury or death.



When you are going downhill, your speed may increase above the set speed. The system will not apply the brakes. Change down a gear to assist the system in maintaining the set speed. Failure to do so could result in loss of vehicle control, serious injury or death.

**Note:** Cruise control will disengage if your vehicle speed decreases more than 10 mph (16 km/h) below your set speed while driving uphill.



E102679

The cruise controls are located on the steering wheel.

### Switching Cruise Control On

Press and release **ON**.



The indicator will display in the instrument cluster.

### Setting a Speed

1. Accelerate to the desired speed.
2. Press and release **SET+**.
3. Take your foot off the accelerator pedal.

### Changing the Set Speed

- Press and hold **SET+** or **SET-**. Release the control when you reach the desired speed.
- Press and release **SET+** or **SET-**. The set speed will change in approximately 1 mph (2 km/h) increments.
- Press the accelerator or brake pedal until you reach the desired speed. Press and release **SET+**.

### Canceling the Set Speed

Press and release **CAN**, or tap the brake pedal. The set speed will not be erased.

## Cruise Control (If Equipped)

---

### Resuming the Set Speed

Press and release **RES**.

### Switching Cruise Control Off

**Note:** *You will erase the set speed if you switch the system off.*

Press and release **OFF** or switch the ignition off.

# Driving Aids

---

## STEERING

### Electric Power Steering

#### WARNINGS



The electric power steering system has diagnostic checks that continuously monitor the system to ensure proper operation. When a system error is detected a steering message will appear in the information display.



The electric power steering system has diagnostic checks that continuously monitor the system to ensure proper operation of the electronic system. When an electronic error is detected, a message will be displayed in the information display. If this happens, stop the vehicle in a safe place, and turn off the engine. After at least 10 seconds, reset the system by restarting the engine, and watch the information display for a steering message. If a steering message returns, or returns while driving, take the vehicle to your dealer to have it checked.



Obtain immediate service if a system error is detected. You may not notice any difference in the feel of your steering, but a serious condition may exist. Failure to do so may result in loss of steering control.

---

Your vehicle is equipped with an electric power-assisted steering system. There is no fluid reservoir to check or fill.

If your vehicle loses electrical power while you are driving (or if the ignition is turned off), you can steer the vehicle manually, but it takes more effort. Extreme continuous steering may increase the effort it takes for you to steer. This occurs to prevent internal overheating and permanent damage to your steering

system. If this should occur, you will neither lose the ability to steer the vehicle manually nor will it cause permanent damage. Typical steering and driving maneuvers will allow the system to cool and steering assist will return to normal.

#### Steering Tips

If the steering wanders or pulls, check for:

- an improperly inflated tire
- uneven tire wear
- loose or worn suspension components
- loose or worn steering components
- improper vehicle alignment

A high crown in the road or high crosswinds may also make the steering seem to wander or pull.

#### Adaptive Learning

The EPS system adaptive learning helps correct for road irregularities and improves overall handling and steering feel. It communicates with the vehicle's brake system to help operate advanced stability control and accident avoidance systems. Additionally, whenever the battery is disconnected or a new battery installed, the vehicle must be driven a short distance before the strategy is relearned and all systems are reactivated.

# Load Carrying

## GENERAL INFORMATION

### WARNINGS



Use load securing straps to an approved standard, e.g. DIN.



Make sure that you secure all loose items properly.



Place luggage and other loads as low and as far forward as possible within the luggage or loadspace.



Do not drive with the liftgate or rear door open. Exhaust fumes may enter your vehicle.



Do not exceed the maximum front and rear axle loads for your vehicle. See **Vehicle Certification Label** (page 237).



Do not allow items to contact the rear windows.

**Note:** When loading long objects in to your vehicle, for example pipes, timber or furniture be careful not to damage the interior trim.

## LOAD LIMIT

### Vehicle Loading - with and without a Trailer

This section will guide you in the proper loading of your vehicle, trailer or both, to keep your loaded vehicle weight within its design rating capability, with or without a trailer. Properly loading your vehicle will provide maximum return of vehicle design performance. Before loading your vehicle, familiarize yourself with the following terms for determining your vehicle's weight ratings, with or without a trailer, from the vehicle's Tire Label or Safety Compliance Certification Label:

**Base Curb Weight** - is the weight of the vehicle including a full tank of fuel and all standard equipment. It does not include passengers, cargo, or optional equipment.

**Vehicle Curb Weight** - is the weight of your new vehicle when you picked it up from your authorized dealer plus any aftermarket equipment.

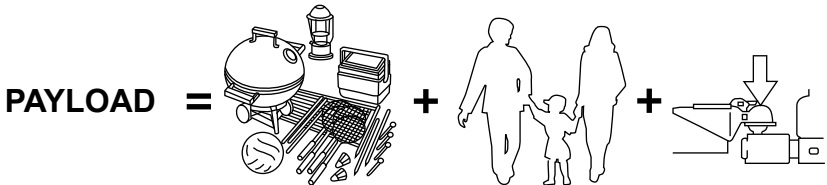

E143816

# Load Carrying

**Payload** - is the combined weight of cargo and passengers that the vehicle is carrying. The maximum payload for your vehicle can be found on the Tire Label on the B-Pillar or the edge of the driver door (vehicles exported outside the US and Canada may not have a Tire Label). Look for **“THE COMBINED WEIGHT OF OCCUPANTS AND CARGO SHOULD NEVER EXCEED XXX kg OR XXX lb.”** for maximum payload. The payload listed on the Tire Label is the maximum payload for the vehicle as built by the assembly plant. If you install any aftermarket or

authorized-dealer installed equipment on the vehicle, you must subtract the weight of the equipment from the payload listed on the Tire Label in order to determine the new payload.

## WARNING

 The appropriate loading capacity of your vehicle can be limited either by volume capacity (how much space is available) or by payload capacity (how much weight the vehicle should carry). Once you have reached the maximum payload of your vehicle, do not add more cargo, even if there is space available. Overloading or improperly loading your vehicle can contribute to loss of vehicle control and vehicle rollover.

### Example only:



### TIRE AND LOADING INFORMATION

SEATING CAPACITY
TOTAL 5
FRONT 2
REAR 3

The combined weight of occupants and cargo should never exceed : **XXX kg or XXX lbs.**

TIRE	SIZE	COLD TIRE PRESSURE	<b>SEE OWNERS MANUAL FOR ADDITIONAL INFORMATION</b>
FRONT	LT225/75R 16.5E	200 KPA, 29 PSI	
REAR	LT225/75R 16.5E	200 KPA, 29 PSI	
SPARE	T145/80D16 P225/60R17	420 KPA, 60 PSI 200 KPA, 29 PSI	

(xxx) xxxxxxxxxxxxxx

E142516

# Load Carrying

TIRE AND LOADING INFORMATION RENSEIGNEMENTS SUR LES PNEUS ET LE CHARGEMENT				
SEATING CAPACITY NOMBRE DE PLACES		TOTAL 5	FRONT AVANT 2	REAR ARRIERE 3
The combined weight of occupants and cargo should never exceed Le poids total des occupants et du chargement ne doit jamais dépasser				492 kg or 1085 lbs.
TIRE PNEU	SIZE DIMENSIONS	COLD TIRE PRESSURE PRESSION DES PNEUS A FROID	SEE OWNER'S MANUAL FOR ADDITIONAL INFORMATION	
FRONT AVANT	P235/70R16	240 KPA, 35 PSI	VOIR LE MANUEL DE L'USAGER POUR PLUS DE RENSEIGNEMENTS	
REAR ARRIERE	P235/70R16	240 KPA, 35 PSI		
SPARE DE SECOURS	T145/90R17	415 KPA, 60 PSI		

E142517

CARGO

=



+

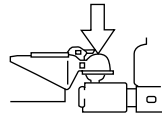

E143817

**Cargo Weight** - includes all weight added to the Base Curb Weight, including cargo and optional equipment. When towing, trailer tongue load or king pin weight is also part of cargo weight.

**GAW (Gross Axle Weight)** - is the total weight placed on each axle (front and rear) including vehicle curb weight and all payload.

**GAW (Gross Axle Weight Rating)** - is the maximum allowable weight that can be carried by a single axle (front or rear). These numbers are shown on the Safety Compliance Certification Label. The label shall be affixed to either the door hinge pillar, door-latch post, or the door edge that meets the door-latch post, next to the driver's seating position. **The total load on each axle must never exceed its Gross Axle Weight Rating.**

# Load Carrying

**Note:** For trailer towing information refer to the RV and Trailer Towing Guide available at an authorized dealer.

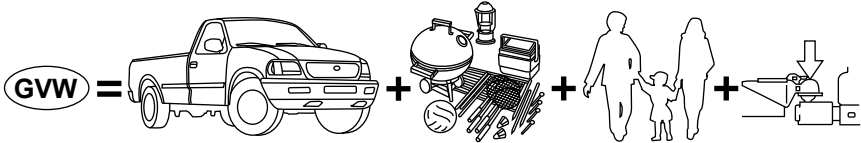

E143818

**GVW (Gross Vehicle Weight)** - is the Vehicle Curb Weight, plus cargo, plus passengers.

**GVWR (Gross Vehicle Weight Rating)** - is the maximum allowable weight of the fully loaded vehicle (including all options, equipment, passengers and cargo). It is shown on the

**Example only:**

Safety Compliance Certification Label. The label shall be affixed to either the door hinge pillar, door-latch post, or the door edge that meets the door-latch post, next to the driver's seating position. **The Gross Vehicle Weight must never exceed the Gross Vehicle Weight Rating.**

**MFD. BY FORD MOTOR CO.**

DATE: XX/XX	GVWR: XXXXXLB/ XXXXXKG
FRONT GAWR: XXXXL	REAR GAWR: XXXXLB
XXXXKG	XXXXKG
WITH	WITH
XXXX/XXXXXXXX	TIRES: XXXX/XXXXXX
XXXX.XX	RIMS: XXXX.XX
AT XXX kPa/XX	PSI COLD
AT XXX kPa/XX	PSI COLD

THIS VEHICLE CONFORMS TO ALL APPLICABLE FEDERAL MOTOR VEHICLE SAFETY STANDARDS IN EFFECT ON THE DATE OF MANUFACTURE SHOWN ABOVE.

VIN: XXXXXXXXXXXXXXXXXXXX      XXXXX  
 TYPE: XXX      XXXXX



EXT PNT: XX	RC: XX	DSO:
WB 1	INT TR	TP/PS
XX	XX	X XX
	AXLE	TR SPR
	X XX	X XX
		XXXX-XXXXXX-XX

E142523

# Load Carrying

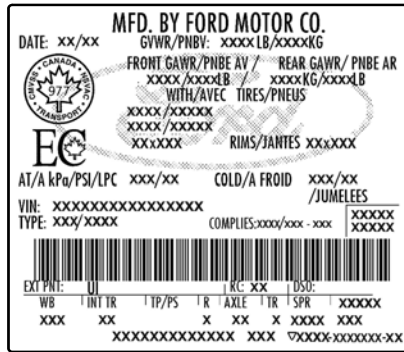

E142524

## WARNING



Exceeding the Safety Compliance Certification Label vehicle weight rating limits could result in substandard vehicle handling or performance, engine, transmission and/or structural damage, serious damage to the vehicle, loss of control and personal injury.

$$\text{GCW} = \text{GVW} +$$

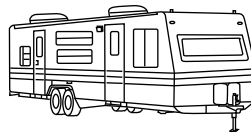

E143819

**GCW (Gross Combined Weight)** - is the Gross Vehicle Weight plus the weight of the fully loaded trailer.

**GCWR (Gross Combined Weight Rating)** - is the maximum allowable weight of the vehicle and the loaded trailer, including all cargo and passengers, that the vehicle can handle without risking damage. (Important: The towing vehicle's braking system is rated



## Load Carrying

---

for operation at Gross Vehicle Weight Rating, not at Gross Combined Weight Rating.) Separate functional brakes should be used for safe control of towed vehicles and for trailers where the Gross Combined Weight of the towing vehicle plus the trailer exceed the Gross Vehicle Weight Rating of the towing vehicle. **The Gross Combined Weight must never exceed the Gross Combined Weight Rating.**

**Maximum Loaded Trailer Weight** - is the highest possible weight of a fully loaded trailer the vehicle can tow. It assumes a vehicle with mandatory options, driver and front passenger weight (150 pounds [68 kilograms] each), no cargo weight (internal or external) and a tongue load of 10–15% (conventional trailer) or king pin weight of 15–25% (fifth wheel trailer). Consult an authorized dealer (or the RV and Trailer Towing Guide available at an authorized dealer) for more detailed information.

**Tongue Load or Fifth Wheel King Pin Weight** - refers to the amount of the weight that a trailer pushes down on a trailer hitch.

**Examples:** For a 5000 pound (2268 kilogram) conventional trailer, multiply 5000 by 0.10 and 0.15 to obtain a proper tongue load range of 500 to 750 pounds (227 to 340 kilograms). For an 11500 pound (5216 kilogram) fifth wheel trailer, multiply by 0.15 and 0.25 to obtain a proper king pin load range of 1725 to 2875 pounds (782 to 1304 kilograms).

### WARNINGS



Do not exceed the GVWR or the GAWR specified on the Safety Compliance Certification Label.



Do not use replacement tires with lower load carrying capacities than the original tires because they may lower the vehicle's GVWR and GAWR limitations. Replacement tires with a higher limit than the original tires do not increase the GVWR and GAWR limitations.



Exceeding any vehicle weight rating limitation could result in serious damage to the vehicle and/or personal injury.

---

### Steps for determining the correct load limit:

1. Locate the statement "The combined weight of occupants and cargo should never exceed XXX kg or XXX lb." on your vehicle's placard.

## Load Carrying

---

- Determine the combined weight of the driver and passengers that will be riding in your vehicle.
- Subtract the combined weight of the driver and passengers from XXX kg or XXX lb.
- The resulting figure equals the available amount of cargo and luggage load capacity. For example, if the “XXX” amount equals 1,400 lb. and there will be five 150 lb. passengers in your vehicle, the amount of available cargo and luggage load capacity is 650 lb.  $(1400 - 750 (5 \times 150) = 650 \text{ lb.})$
- Determine the combined weight of luggage and cargo being loaded on the vehicle. That weight may not safely exceed the available cargo and luggage load capacity calculated in Step 4.
- If your vehicle will be towing a trailer, load from your trailer will be transferred to your vehicle. Consult this manual to determine how this reduces the available cargo and luggage load capacity of your vehicle.

The following gives you a few examples on how to calculate the available amount of cargo and luggage load capacity:

\*Suppose your vehicle has a 1400-pound (635-kilogram) cargo and luggage capacity. You decide to go golfing. Is there enough load capacity to carry you, four of your friends and all the golf bags? You and four friends average 220 pounds (99 kilograms) each and the golf bags weigh approximately 30 pounds (13.5 kilograms) each. The calculation would be:  $1400 - (5 \times 220) - (5 \times 30) = 1400 - 1100 - 150 = 150$  pounds. Yes, you have enough load capacity in your vehicle to transport four friends and your golf bags. In metric units, the calculation would be:  $635 \text{ kilograms} - (5 \times 99 \text{ kilograms}) - (5 \times 13.5 \text{ kilograms}) = 635 - 495 - 67.5 = 72.5$  kilograms.

\*Suppose your vehicle has a 1400-pound (635-kilogram) cargo and luggage capacity. You and one of your friends decide to pick up cement from the local home improvement store to finish that patio you have been planning for the past two years. Measuring the inside of the vehicle with the rear seat folded down, you have room for twelve 100-pound (45-kilogram) bags of cement. Do you have enough load capacity to transport the cement to your home? If you and your friend each weigh 220 pounds (99 kilograms), the calculation would be:  $1400 - (2 \times 220) - (12 \times 100) = 1400 - 440 - 1200 = -240$  pounds. No, you do not have enough cargo capacity to carry that much weight. In metric units, the calculation would

# Load Carrying

be: 635 kilograms - (2 x 99 kilograms) - (12 x 45 kilograms) = 635 - 198 - 540 = -103 kilograms. You will need to reduce the load weight by at least 240 pounds (104 kilograms). If you remove three 100-pound (45-kilogram) cement bags, then the load calculation would be: 1400 - (2 x 220) - (9 x 100) = 1400 - 440 - 900 = 60 pounds. Now you have the load capacity to transport the cement and your friend home. In metric units, the calculation would be: 635 kilograms - (2 x 99 kilograms) - (9 x 45 kilograms) = 635 - 198 - 405 = 32 kilograms.

The above calculations also assume that the loads are positioned in your vehicle in a manner that does not overload the Front or the Rear Gross Axle Weight Rating specified for your vehicle on the Safety Compliance Certification Label. The label shall be affixed to either the door hinge pillar, door-latch post, or the door edge that meets the door-latch post, next to the driver's seating position.

## REAR UNDER FLOOR STORAGE (IF EQUIPPED)

### Adjustable Load Floor

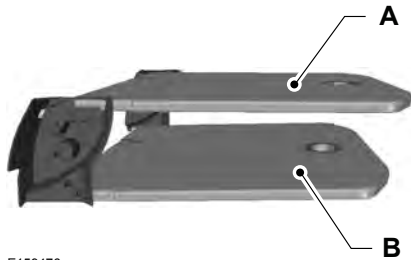

E159476

- A Upper position
- B Lower position

The load floor can be placed in either position on shelves located at the rear of the luggage compartment trim.

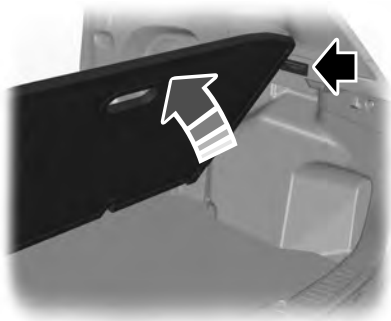

E157606

You can hold the load floor open. Use the stoppers located at the side of the luggage compartment to hold the floor up.

# Load Carrying

## CARGO NETS (IF EQUIPPED)

### Installing and Removing the Cargo Net

#### Installing the Cargo Net

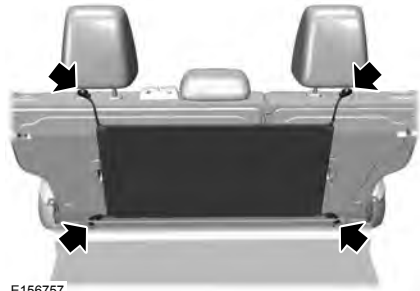

E156757

1. Raise the rear outer head restraints. See **Head Restraints** (page 105).
2. Attach the top securing clips to the head restraint outer posts.
3. Attach the bottom securing clips to the anchor points.

#### Removing the Cargo Net

1. Raise the rear outer head restraints. See **Head Restraints** (page 105).
2. Detach the top and bottom securing clips.

## LUGGAGE COVERS

### WARNING



Do not place objects on the luggage cover.

### Removing the Cover

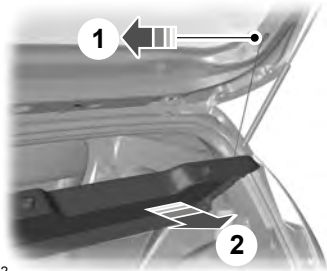

E72512

# Towing

## TOWING A TRAILER - 1.6L ECOBOOST™

### WARNING

 Your vehicle is not approved for trailer towing.

## TRANSPORTING THE VEHICLE

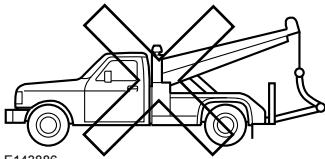
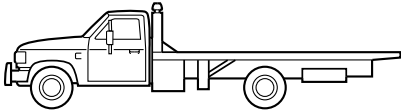
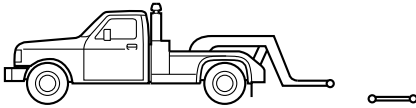

E143886

If you need to have your vehicle towed, contact a professional towing service or, if you are a member of a roadside assistance program, your roadside assistance service provider.

It is recommended that your vehicle be towed with a wheel lift and dollies or flatbed equipment. Do not tow with a slingbelt. Ford Motor Company has not approved a slingbelt towing procedure. If the vehicle is towed incorrectly, or by any other means, vehicle damage may occur.

Ford Motor Company produces a towing manual for all authorized tow truck operators. Have your tow truck operator refer to this manual for proper hook-up and towing procedures for your vehicle.

You can tow your vehicle from the front with wheel lift equipment to raise the front wheels off the ground. We recommend that you place the rear wheels on a dolly to prevent damage to the rear of your vehicle.

You can tow your vehicle from the rear with wheel lift equipment.

**Note:** You must place the front wheels on a dolly to prevent damage to the transmission.

## TOWING THE VEHICLE ON FOUR WHEELS

### Emergency Towing

If your vehicle is disabled without access to wheel dollies, a car-hauling trailer, or a flatbed transport vehicle it can be flat-towed with all wheels on the ground.

You may do this under the following conditions:

- Your vehicle is facing forward so that it is towed in a forward direction.
- The transmission gear shift lever is placed in position **N**. If the transmission gear shift lever cannot be moved to position **N**, it may need to be overridden. See **Transmission** (page 126).

# Towing

- Maximum speed is 35 mph (56 km/h).
- Maximum distance is 50 miles (80 kilometers).

## Recreational Towing

**Note:** Put your climate control system in recirculated air mode to prevent exhaust fumes from entering the vehicle.

Follow these guidelines if you have a need for recreational (RV) towing. An example of recreational towing would be towing your vehicle behind a motorhome. These guidelines are designed to ensure that your transmission is not damaged.

### Vehicles with a Manual Transmission

Your vehicle can be towed with all four wheels on the ground or with the front wheels off the ground by using a tow dolly. If you are using a tow dolly follow the instructions specified by the equipment provider. If you tow your vehicle with all wheels on the ground, follow these instructions:

1. Tow only with your vehicle in the forward direction. Release the parking brake.
2. Place the transmission in neutral.
3. Place the ignition in the accessory position. See **Starting and Stopping the Engine** (page 113).

**Note:** Do not exceed 70 mph (113 km/h) when towing your vehicle.

### Vehicles with an Automatic Transmission - with Ignition Switch

**Note:** There must be battery power to properly move the transmission's internal components to neutral in step 3. Also, moving the gearshift to the neutral position without first turning the ignition to the on **II** position limits the towing capability to 35 mph (56 km/h) and 50 miles (80 kilometers).

1. Release the parking brake.
2. Switch the ignition to the on (**II**) position.
3. Press the brake pedal, then move the gearshift to the neutral position.
4. Wait for a message indicating that the transmission is ready in the information and entertainment display, then switch the ignition off and release the brake pedal.
5. Disconnect the negative (black) cable from the battery. The anti-theft system is disabled until the battery cable is reconnected. See **Changing the 12V Battery** (page 186).

**Note:** The maximum towing speed is 70 mph (113 km/h).

**Note:** There is no limit on towing distance.

After towing, start the engine within 15 minutes of reconnecting the battery cable. See **Changing the 12V Battery** (page 186).

### Vehicles with an Automatic Transmission - with Keyless Starting

**Note:** There must be battery power to properly move the transmission's internal components to neutral in step 3. Also, moving the gearshift to the neutral position without first turning the ignition to the on **II** position limits the towing capability to 35 mph (56 km/h) and 50 miles (80 kilometers).

1. Release the parking brake.
2. Switch the ignition on by pressing the keyless start button, but do not apply the brake pedal.
3. Press the brake pedal, then move the gearshift to the neutral position. Release the brake pedal.

# Towing

---

4. Wait for a message indicating that the transmission is ready in the information and entertainment display, then switch the ignition off by pressing the keyless start button.
5. Disconnect the negative (black) cable from the battery. The door key is needed to lock and unlock doors when the battery cable is disconnected. Also, the anti-theft system is disabled until the battery cable is reconnected. See **Changing the 12V Battery** (page 186).

**Note:** *The maximum towing speed is 70 mph (113 km/h).*

**Note:** *There is no limit on towing distance.*

After towing, start the engine within 15 minutes of reconnecting the battery cable. See **Changing the 12V Battery** (page 186).

# Driving Hints

## BREAKING-IN

### Tires

#### WARNING



New tires need to be run-in for approximately 300 miles (500 kilometers). During this time, you may experience different driving characteristics.

### Brakes and Clutch

#### WARNING



Avoid heavy use of the brakes and clutch if possible for the first 100 miles (150 kilometers) in town and for the first 1000 miles (1500 kilometers) on freeways.

### Engine

#### WARNING



Avoid driving too fast during the first 1000 miles (1500 kilometers). Vary your speed frequently and change up through the gears early. Do not labor the engine.

## COLD WEATHER PRECAUTIONS

The functional operation of some components and systems can be affected at temperatures below -13°F (-25°C).

## DRIVING THROUGH WATER

**Note:** *Driving through deep water above the recommended levels can cause vehicle damage.*

If driving through deep or standing water is unavoidable, proceed very slowly. Never drive through water that is higher than the bottom of the wheel rims (for cars) or the bottom of the hubs (for trucks).

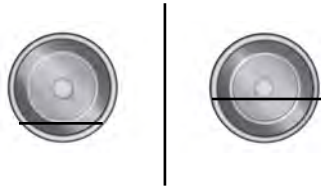

E142667

When driving through water, traction or brake capability may be limited. Also, water may enter your engine's air intake and severely damage your engine or your vehicle may stall.

Once through the water, always dry the brakes by moving your vehicle slowly while applying light pressure on the brake pedal. Wet brakes do not stop the vehicle as quickly as dry brakes.

## ECONOMICAL DRIVING

Fuel economy is affected by several things such as how you drive, the conditions you drive under and how you maintain your vehicle.

There are some things to keep in mind that may improve your fuel economy:

- Accelerate and slow down in a smooth, moderate fashion.
- Drive at steady speeds.
- Anticipate stops; slowing down may eliminate the need to stop.



## Driving Hints

- Combine errands and minimize stop-and-go driving.
  - When running errands, go to the furthest destination first and then work your way back home.
- Close the windows for high-speed driving.
- Drive at reasonable speeds. (Traveling at 65 mph/105 kph uses about 15% less fuel than traveling at 75 mph/121 kph).
- Keep the tires properly inflated and use only the recommended size.
- Use the recommended engine oil.
- Perform all regularly scheduled maintenance.

There are also some things you may want to avoid doing because they reduce your fuel economy:





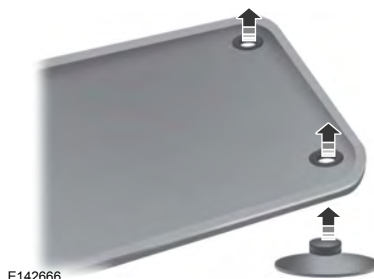

- Avoid sudden or hard accelerations.
- Avoid revving the engine before turning off the car.
- Avoid long idle periods.
- Do not warm up your vehicle on cold mornings.
- Reduce the use of air conditioning and heat.
- Avoid using speed control in hilly terrain.
- Do not rest your foot on the brake pedal while driving.
- Avoid carrying unnecessary weight (approximately 1 mpg [0.4 kilometers/liter] is lost for every 400 lbs [180 kilograms] of weight carried).
- Avoid adding particular accessories to your vehicle (e.g. bug deflectors, rollbars/light bars, running boards, ski racks).
- Avoid driving with the wheels out of alignment.

### FLOOR MATS



E142666

#### WARNINGS

-  Always use floor mats that are designed to fit the foot well of your vehicle, leaving the pedal area unobstructed, and which can be firmly secured to retention posts so that they cannot slip out of position and interfere with the pedals or impair safe operation of your vehicle in other ways.
-  Incorrectly fitted floor mats can cause the accelerator pedal to become stuck in the open position. This can cause loss of vehicle control.
-  Always correctly install the floor mats to the retention posts so that they cannot slip out of position or obstruct pedal operation.
-  Do not place unsecured floor mats or any other covering in the foot well.
-  Do not place additional floor mats or any other covering on top of the original floor mats. This will reduce the pedal clearance and interfere with the pedal operation.
-  Do not allow objects to fall or become trapped under the pedals of your vehicle. This can cause loss of vehicle control.
-  Carry out regular inspections to make sure the floor mats are secure.

## Driving Hints

---

To install the floor mats, position the floor mat eyelet over the retention post and press down to lock in position.

Remove in reverse order.

# Customer Assistance

---

## GETTING THE SERVICES YOU NEED

Warranty repairs to your vehicle must be performed by an authorized dealer. While any authorized dealer handling your vehicle line will provide warranty service, we recommend you return to your selling authorized dealer who wants to ensure your continued satisfaction.

Please note that certain warranty repairs require special training and equipment, so not all authorized dealers are authorized to perform all warranty repairs. This means that, depending on the warranty repair needed, you may have to take your vehicle to another authorized dealer.

A reasonable time must be allowed to perform a repair after taking your vehicle to the authorized dealer. Repairs will be made using Ford or Motorcraft® parts, or remanufactured or other parts that are authorized by Ford.

## Away From Home

If you are away from home when your vehicle needs service, contact the Ford Customer Relationship Center or use the online resources listed below to find the nearest authorized dealer.

In the United States:

### Mailing address

Ford Motor Company  
Customer Relationship Center  
P.O. Box 6248  
Dearborn, MI 48121

### Telephone

1-800-392-3673 (FORD)  
(TDD for the hearing impaired:  
1-800-232-5952)

### Online

Additional information and resources are available online at [www.fordowner.com](http://www.fordowner.com)

These are some of the items that can be found online:

- U.S. dealer locator by Dealer Name, City/State, or Zip Code
- Owner Manuals
- Maintenance Schedules
- Recalls
- Ford Extended Service Plans
- Ford Genuine Accessories
- Service specials and promotions.

In Canada:

### Mailing address

Customer Relationship Centre  
Ford Motor Company of Canada, Limited  
P.O. Box 2000  
Oakville, Ontario L6K 0C8

### Telephone

1-800-565-3673 (FORD)

### Online

[www.ford.ca](http://www.ford.ca)

## Additional Assistance

If you have questions or concerns, or are unsatisfied with the service you are receiving, follow these steps:

1. Contact your Sales Representative or Service Advisor at your selling/servicing authorized dealer.
2. If your inquiry or concern remains unresolved, contact the Sales Manager, Service Manager or Customer Relations Manager.
3. If you require assistance or clarification on Ford Motor Company policies, please contact the Ford Customer Relationship Center.

# Customer Assistance

---

In order to help you serve you better, please have the following information available when contacting a Customer Relationship Center:

- Vehicle Identification Number.
- Your telephone number (home and business).
- The name of the authorized dealer and city where located.
- The vehicle's current odometer reading.

In some states, you must directly notify Ford in writing before pursuing remedies under your state's warranty laws. Ford is also allowed a final repair attempt in some states.

In the United States, a warranty dispute must be submitted to the BBB AUTO LINE before taking action under the Magnuson-Moss Warranty Act, or to the extent allowed by state law, before pursuing replacement or repurchase remedies provided by certain state laws. This dispute handling procedure is not required prior to enforcing state created rights or other rights which are independent of the Magnuson-Moss Warranty Act or state replacement or repurchase laws.

## **IN CALIFORNIA (U.S. ONLY)**

California Civil Code Section 1793.2(d) requires that, if a manufacturer or its representative is unable to repair a motor vehicle to conform to the vehicle's applicable express warranty after a reasonable number of attempts, the manufacturer shall be required to either replace the vehicle with one substantially identical or repurchase the vehicle and reimburse the buyer in an amount equal to the actual price paid or payable by the consumer (less a reasonable allowance for consumer use). The consumer has the right to choose whether to receive a refund or replacement vehicle.

California Civil Code Section 1793.22(b) presumes that the manufacturer has had a reasonable number of attempts to conform the vehicle to its applicable express warranties if, within the first 18 months of ownership of a new vehicle or the first 18000 miles (29 000 km), whichever occurs first:

1. Two or more repair attempts are made on the same non-conformity likely to cause death or serious bodily injury OR
2. Four or more repair attempts are made on the same nonconformity (a defect or condition that substantially impairs the use, value or safety of the vehicle) OR
3. The vehicle is out of service for repair of nonconformities for a total of more than 30 calendar days (not necessarily all at one time).

In the case of 1 or 2 above, the consumer must also notify the manufacturer of the need for the repair of the nonconformity at the following address:

Ford Motor Company  
16800 Executive Plaza Drive  
Mail Drop 3NE-B  
Dearborn, MI 48126

You are required to submit your warranty dispute to BBB AUTO LINE before asserting in court any rights or remedies conferred by California Civil Code Section 1793.22(b). You are also required to use BBB AUTO LINE before exercising rights or seeking remedies created by the Federal Magnuson-Moss Warranty Act, 15 U.S.C. sec. 2301 et seq. If you choose to seek redress by pursuing rights and remedies not created by California Civil Code Section 1793.22(b) or the Magnuson-Moss Warranty Act, resort to BBB AUTO LINE is not required by those statutes.

## Customer Assistance

---

### **THE BETTER BUSINESS BUREAU (BBB) AUTO LINE PROGRAM (U.S. ONLY)**

Your satisfaction is important to Ford Motor Company and to your dealer. If a warranty concern has not been resolved using the three-step procedure outlined earlier in this chapter in the Getting the Services you need section, you may be eligible to participate in the BBB AUTO LINE program.

The BBB AUTO LINE program consists of two parts – mediation and arbitration. During mediation, a representative of the BBB will contact both you and Ford Motor Company to explore options for settlement of the claim. If an agreement is not reached during mediation or you do not want to participate in mediation, and if your claim is eligible, you may participate in the arbitration process. An arbitration hearing will be scheduled so that you can present your case in an informal setting before an impartial person. The arbitrator will consider the testimony provided and make a decision after the hearing.

Disputes submitted to the BBB AUTO LINE program are usually decided within forty days after you file your claim with the BBB. You are not bound by the decision, and may reject the decision and proceed to court where all findings of the BBB Auto Line dispute, and decision, are admissible in the court action. Should you choose to accept the BBB AUTO LINE decision, Ford is then bound by the decision, and must comply with the decision within 30 days of receipt of your acceptance letter.

**BBB AUTO LINE Application:** Using the information provided below, please call or write to request a program application. You will be asked for your name and address, general information about your new vehicle, information about your warranty concerns, and any steps you have

already taken to try to resolve them. A Customer Claim Form will be mailed that will need to be completed, signed and returned to the BBB along with proof of ownership. Upon receipt, the BBB will review the claim for eligibility under the Program Summary Guidelines.

**You can get more information by calling BBB AUTO LINE at 1-800-955-5100, or writing to:**

**BBB AUTO LINE  
4200 Wilson Boulevard, Suite 800  
Arlington, Virginia 22203-1833**

BBB AUTO LINE applications can also be requested by calling the Ford Motor Company Customer Relationship Center at 1-800-392-3673.

**Note:** *Ford Motor Company reserves the right to change eligibility limitations, modify procedures, or to discontinue this process at any time without notice and without obligation.*

### **UTILIZING THE MEDIATION/ARBITRATION PROGRAM (CANADA ONLY)**

For vehicles delivered to authorized Canadian dealers. In those cases where you continue to feel that the efforts by Ford of Canada and the authorized dealer to resolve a factory-related vehicle service concern have been unsatisfactory, Ford of Canada participates in an impartial third party mediation/arbitration program administered by the Canadian Motor Vehicle Arbitration Plan (CAMVAP).

The CAMVAP program is a straight forward and relatively speedy alternative to resolve a disagreement when all other efforts to produce a settlement have failed. This procedure is without cost to you and is designed to eliminate the need for lengthy and expensive legal proceedings.

# Customer Assistance

---

In the CAMVAP program, impartial third-party arbitrators conduct hearings at mutually convenient times and places in an informal environment. These impartial arbitrators review the positions of the parties, make decisions and, when appropriate, render awards to resolve disputes. CAMVAP decisions are fast, fair, and final as the arbitrator's award is binding on both you and Ford of Canada.

CAMVAP services are available in all Canadian territories and provinces. For more information, without charge or obligation, call your CAMVAP Provincial Administrator directly at 1-800-207-0685 or visit [www.camvap.ca](http://www.camvap.ca).

## GETTING ASSISTANCE OUTSIDE THE U.S. AND CANADA

Before exporting your vehicle to a foreign country, contact the appropriate foreign embassy or consulate. These officials can inform you of local vehicle registration regulations and where to find unleaded fuel.

If you cannot find unleaded fuel or can only get fuel with an anti-knock index lower than is recommended for your vehicle, contact our Customer Relationship Center.

The use of leaded fuel in your vehicle without proper conversion may damage the effectiveness of your emission control system and may cause engine knocking or serious engine damage. Ford Motor Company or Ford of Canada is not responsible for any damage caused by use of improper fuel. Using leaded fuel may also result in difficulty importing your vehicle back into the United States.

If your vehicle must be serviced while you are traveling or living in Asia-Pacific Region, Sub-Saharan Africa, U.S. Virgin Islands, Central America, the Caribbean, and Israel, contact the nearest authorized dealer. If the authorized dealer cannot help you, contact:

FORD MOTOR COMPANY  
FORD EXPORT OPERATIONS & GLOBAL INITIATIVES

Customer Relationship Center  
1555 Fairlane Drive  
Fairlane Business Park #3  
Allen Park, Michigan 48101  
U.S.A.

Telephone: (313) 594-4857

Fax: (313) 390-0804

Email: [expcac@ford.com](mailto:expcac@ford.com)

For customers in Guam, the Commonwealth of the Northern Mariana Islands (CNMI), America Samoa, and the U.S. Virgin Islands, please feel free to call our Toll-Free Number: (800) 841-FORD (3673).

If your vehicle must be serviced while you are traveling or living in Puerto Rico, contact the nearest authorized dealer. If the authorized dealer cannot help you, contact:

FORD MOTOR COMPANY  
FORD EXPORT OPERATIONS & GLOBAL INITIATIVES

Customer Relationship Center  
1555 Fairlane Drive  
Fairlane Business Park #3  
Allen Park, Michigan 48101  
U.S.A.

Telephone: (800) 841-FORD (3673)

FAX: (313) 390-0804

Email: [prcac@ford.com](mailto:prcac@ford.com)

[www.ford.com.pr](http://www.ford.com.pr)

If your vehicle must be serviced while you are traveling or living in the Middle East, contact the nearest authorized dealer. If the authorized dealer cannot help you, contact:

## Customer Assistance

Ford Middle East  
Customer Relationship Center  
P.O. Box 21470  
Dubai, United Arab Emirates  
Telephone: +971 4 3326084  
Toll-Free Number for the Kingdom of Saudi Arabia: 800 8971409  
Local Telephone Number of Kuwait: 24810575  
FAX: +971 4 3327299  
Email: [menacac@ford.com](mailto:menacac@ford.com)  
[www.me.ford.com](http://www.me.ford.com)

If you buy your vehicle in North America and then relocate to any of the above locations, register your vehicle identification number (VIN) and new address with Ford Motor Company Export Operations & Global Growth Initiatives by emailing [expcac@ford.com](mailto:expcac@ford.com).

If you are in another foreign country, contact the nearest authorized dealer. In the event your inquiry is unresolved, communicate your concern with the dealership's Sales Manager, Service Manager or Customer Relations Manager. If you require additional assistance or clarification, please contact the respective Customer Relationship Center as previously listed.

**Customers in the U.S. should call  
1-800-392-3673.**

### ORDERING ADDITIONAL OWNER'S LITERATURE

To order the publications in this portfolio, contact Helm, Incorporated at:

HELM, INCORPORATED  
47911 Halyard Drive  
Plymouth, Michigan 48170  
Attention: Customer Service

Or to order a free publication catalog, call toll free: 1-800-782-4356

Monday-Friday 8:00 a.m. - 6:00 p.m. EST

Helm, Incorporated can also be reached by their website:

[www.helminc.com](http://www.helminc.com)

(Items in this catalog may be purchased by credit card, check or money order.)

### Obtaining a French Owner's Manual

French Owner's Manual can be obtained from your authorized dealer or by contacting Helm, Incorporated using the contact information listed previously in this section.

### REPORTING SAFETY DEFECTS (U.S. ONLY)



E142557

If you believe that your vehicle has a defect which could cause a crash or could cause injury or death, you should immediately inform the National Highway Traffic Safety Administration (NHTSA) in addition to notifying Ford Motor Company.

If NHTSA receives similar complaints, it may open an investigation, and if it finds that a safety defect exists in a group of vehicles, it may order a recall and remedy campaign. However, NHTSA cannot become involved in individual problems between you, your dealer, or Ford Motor Company.

## Customer Assistance

---

To contact NHTSA, you may call the Vehicle Safety Hotline toll-free at 1-888-327-4236 (TTY: 1-800-424-9153); go to <http://www.safercar.gov>; or write to:

Administrator  
1200 New Jersey Avenue,  
Southeast  
Washington, D.C. 20590

You can also obtain other information about motor vehicle safety from <http://www.safercar.gov>.

### **REPORTING SAFETY DEFECTS (CANADA ONLY)**

If you believe that your vehicle has a defect which could cause a crash or could cause injury or death, you should immediately inform Transport Canada.

<b>Transport Canada Contact Information</b>	
Website	<a href="http://www.tc.gc.ca/eng/roadsafety/menu.htm">http://www.tc.gc.ca/eng/roadsafety/menu.htm</a>
Phone	1-800-333-0510



# Roadside Emergencies

## ROADSIDE ASSISTANCE

### Vehicles Sold In The U.S.: Getting Roadside Assistance

To fully assist you should you have a vehicle concern, Ford Motor Company offers a complimentary roadside assistance program. This program is separate from the New Vehicle Limited Warranty. The service is available:

- 24 hours, seven days a week.
- for the coverage period listed on the Roadside Assistance Card included in your Owner's Manual portfolio.

Roadside assistance will cover:

- a flat tire change with a good spare, if provided with the vehicle (except vehicles that have been supplied with a tire inflation kit).
- battery jump start.
- lock-out assistance (key replacement cost is the customer's responsibility).
- fuel delivery — Independent Service Contractors, if not prohibited by state, local or municipal law, shall deliver up to 2.0 gallons (7.5 liters) of gasoline or 5.0 gallons (18.9 liters) of diesel fuel to a disabled vehicle. Fuel delivery service is limited to two no-charge occurrences within a 12-month period.
- winch out — available within 100 feet (30.5 meters) of a paved or county maintained road, no recoveries.
- towing — Ford and Lincoln eligible vehicles towed to an authorized dealer within 35 miles (56.3 kilometers) of the disablement location or to the nearest authorized dealer. If a member requests to be towed to an authorized dealer more than 35 miles (56.3 kilometers) from the disablement location, the member shall be responsible for any mileage costs in excess of 35 miles (56.3 kilometers).

Trailers shall be covered up to \$200 if the disabled eligible vehicle requires service at the nearest authorized dealer. If the trailer is disabled, but the towing vehicle is operational, the trailer does not qualify for any roadside services.

### Vehicles Sold In The U.S. : Using Roadside Assistance

Complete the roadside assistance identification card and place it in your wallet for quick reference. This card is found in the owner's information portfolio in the glove compartment.

U.S. Ford vehicle customers who require Roadside Assistance, call 1-800-241-3673.

If you need to arrange roadside assistance for yourself, Ford Motor Company will reimburse a reasonable amount for towing to the nearest dealership within 35 miles (56.3 kilometers). To obtain reimbursement information, U.S. Ford vehicle customers call 1-800-241-3673. Customers will be asked to submit their original receipts.

### Vehicles Sold In Canada : Getting Roadside Assistance

Canadian customers who require roadside assistance, call 1-800-665-2006.

### Vehicles Sold In Canada : Using Roadside Assistance

For your convenience, you may complete the roadside assistance identification card found in the centerfold of your warranty guide and retain for future reference.

Canadian roadside coverage and benefits may differ from the U.S. coverage. If you require more information, please refer to the coverage section of your warranty guide, call us in Canada at 1-800-665-2006, or visit our website at [www.ford.ca](http://www.ford.ca).

# Roadside Emergencies

## HAZARD WARNING FLASHERS

**Note:** *If used when the vehicle is not running, the battery will lose charge. There may be insufficient power to restart your vehicle.*



The hazard warning button is located on the instrument panel. Use it when your vehicle is creating a safety hazard for other motorists.

- Press the button to turn on the hazard warning function, and the front and rear direction indicators will flash.
- Press the button again to turn them off.

## FUEL SHUTOFF

### WARNING



Failure to inspect and, if necessary, repair fuel leaks after a collision may increase the risk of fire and serious injury. Ford Motor Company recommends that the fuel system be inspected by an authorized dealer after any collision.

In the event of a moderate to severe collision, this vehicle is equipped with a fuel pump shut-off feature that stops the flow of fuel to the engine. Not every impact will cause a shut-off.

Should your vehicle shut off after a collision, you may restart your vehicle by doing the following:

1. Turn the ignition off.
2. Turn the ignition to crank.
3. Turn the ignition off.
4. Turn the ignition on again to re-enable the fuel pump.

For vehicles equipped with a push button start system:

1. Press the **START/STOP** button to turn the ignition off.
2. Press the brake pedal and press the **START/STOP** button (crank attempt).
3. Remove your foot from the brake pedal and press the **START/STOP** button (ignition off).
4. Press the **START/STOP** button again to re-enable the fuel system.

## JUMP-STARTING THE VEHICLE

### WARNINGS



Do not use fuel lines, engine rocker covers or the intake manifold as grounding points.



Connect batteries with only the same nominal voltage.



Always use booster cables with insulated clamps and adequate size cable.

**Note:** *Do not disconnect the battery from your vehicle's electrical system.*

# Roadside Emergencies

## To Connect the Booster Cables

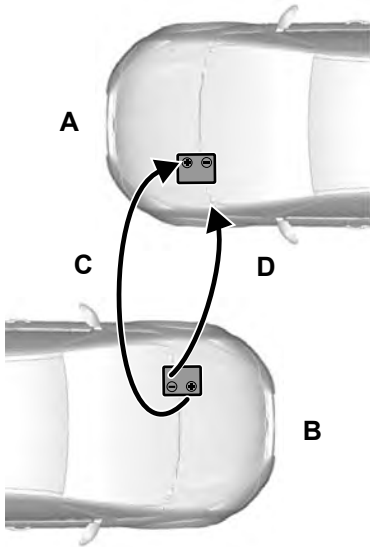

E102925

- A Vehicle with low charge battery
- B Booster battery vehicle
- C Positive connection cable
- D Negative connection cable

1. Position the vehicles so that they do not touch one another.
2. Switch off the engine and any electrical equipment.
3. Connect the positive (+) terminal of vehicle B with the positive (+) terminal of vehicle A (cable C).



E102923

4. Connect the negative (-) terminal of vehicle B to the ground connection of vehicle A (cable D).

### WARNINGS



Do not connect directly to the negative (-) terminal of the battery with low charge.



Make sure that the cables are clear of any moving parts and fuel delivery system parts.

## To Start the Engine

1. Run the engine of vehicle B at a moderately high speed.
2. Start the engine of vehicle A.
3. Run both vehicles for a minimum of three minutes before disconnecting the cables.

### WARNING



Do not switch on the headlamps when disconnecting the cables. The peak voltage could blow the bulbs.

Disconnect the cables in the reverse order.

# Fuses

## FUSE SPECIFICATION CHART

### Engine Compartment Fuse Box

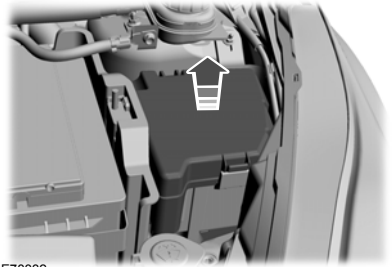

E78332

### 4-door and 5-door

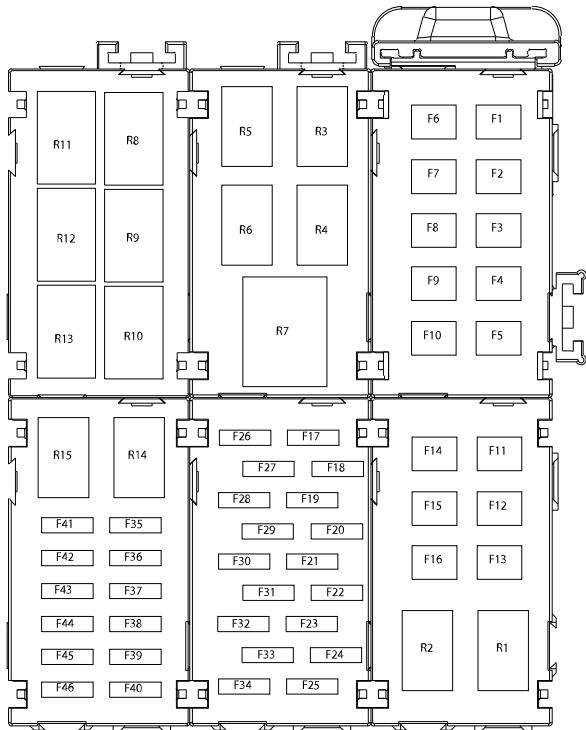

E156752

# Fuses

<b>Fuse</b>	<b>Fuse rating</b>	<b>Circuits protected</b>
1	60 A	Electronic stability program module
1	40 A	Anti-lock braking system
2	40 A	Transmission control unit
3	40 A	Engine cooling fan
3	60 A	Engine cooling fan module
4	40 A	Heater blower
5	60 A	Passenger compartment fuse box supply (battery)
6	30 A	Locking and unlocking
7	60 A	Ignition switch
8	60 A	Powertrain control module
9	40 A	Electronic stability program module
10	30 A	Engine start inhibitor
11	30 A	Fuel system
12	60 A	Power windows
13	60 A	High speed cooling fan
14	-	Not used
15	-	Not used
16	-	Not used
17	20 A	High beam
18	15 A	Powertrain control module
19	20 A	Fog lamps
20	15 A	Emissions system
21	7.5 A	Fog lamps, high beam
22	15 A	Ignition coil
22	20 A	Ignition coil
23	15 A	Exterior lamps right-hand side

## Fuses

<b>Fuse</b>	<b>Fuse rating</b>	<b>Circuits protected</b>
24	10 A	Emissions system
25	15 A	Exterior lamps left-hand side
26	20 A	Horn, battery back-up sounder, interior lamps
27	7.5 A	Engine cold start system module
27	15 A	Water pump, active grill shutter
28	15 A	Direction indicators
29	20 A	Compressed natural gas, fuel control module
30	10 A	Air conditioning clutch
31	-	Not used
32	7.5 A	Powertrain control module, transmission control unit
33	10 A	Fuel injectors
33	7.5 A	Mass air flow sensor
34	30 A	Heated exterior mirrors
35	10 A	Fog lamp left-hand side
36	10 A	Fog lamp right-hand side
37	10 A	High beam left-hand side
38	10 A	High beam right-hand side
39	-	Not used
40	-	Not used
41	-	Not used
42	-	Not used
43	-	Not used
44	-	Not used
45	-	Not used
46	-	Not used

# Fuses

---

<b>Relay</b>	<b>Circuits switched</b>
R1	Compressed natural gas fuel system
R2	Not used
R3	Powertrain control module
R4	Heater blower
R5	Engine cooling fan
R6	Air conditioning clutch
R7	High speed engine cooling fan
R8	Not used
R9	Engine start inhibitor
R10	High beam
R11	Fog lamps
R12	Reversing lamp
R13	Fuel pump

## **Passenger Compartment Fuse Box**

This fuse box is located behind the glove box. Open the glove box and empty the contents. Press the sides inwards and swivel the glove box downward.

# Fuses

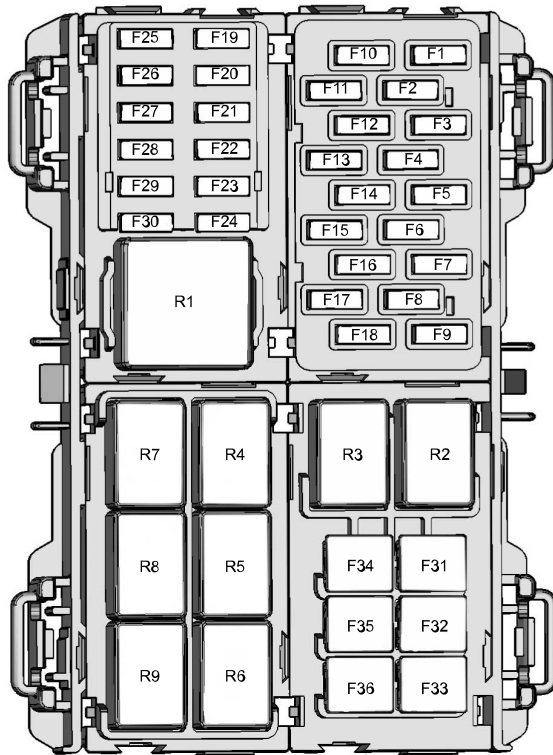

E156756

Fuse	Fuse rating	Circuits protected
1	15 A	Ignition switch
2	7.5 A	Interior mirror, autowipers, heater relay control
3	7.5 A	Instrument cluster
4	7.5 A	Passenger airbag deactivation indicator, passenger sensing system
5	15 A	On-board diagnostics connector



## Fuses

<b>Fuse</b>	<b>Fuse rating</b>	<b>Circuits protected</b>
6	10 A	Reversing lamps
7	7.5 A	Instrument panel, information and entertainment display
8	7.5 A	Moonroof
9	20 A	Keyless entry, keyless starting
10	15 A	Audio unit, SYNC
11	20 A	Windshield wipers
12	7.5 A	Climate control
13	15 A	Rear window wiper
14	20 A	Keyless entry, keyless starting
15	15 A	Wiper switch
16	5 A	Electric exterior mirrors, power windows
17	15 A	Heated seats
18	10 A	Brake lamp
19	7.5 A	Instrument cluster
20	10 A	Airbags
21	7.5 A	Electronic power assisted steering, instrument cluster, ignition, wipers, passive anti-theft system
22	7.5 A	Transmission control unit, powertrain control module, anti-lock braking system, electronic stability program
23	7.5 A	Transmission control unit
24	7.5 A	Audio unit
25	7.5 A	Electric exterior mirrors
26	7.5 A	Locking and unlocking
27	-	Not used
28	-	Not used
29	-	Not used
30	-	Not used
31	30 A	Power windows

# Fuses

Fuse	Fuse rating	Circuits protected
32	20 A	Battery back-up sounder
33	20 A	Auxilliary power points
34	30 A	Power windows
35	20 A	Moonroof
36	-	Not used

Relay	Circuits switched
R1	Ignition relay
R2	Not used
R3	Not used
R4	Driver heated seat
R5	Passenger heated seat
R6	Keyless starting
R7	Keyless starting
R8	Battery back-up sounder
R9	Accessory delay

## CHANGING A FUSE

### Fuses

#### WARNING



Always replace a fuse with one that has the specified amperage rating. Using a fuse with a higher amperage rating can cause severe wire damage and could start a fire.

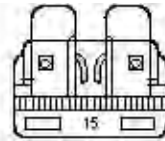

E142430

If electrical components in the vehicle are not working, a fuse may have blown. Blown fuses are identified by a broken wire within the fuse. Check the appropriate fuses before replacing any electrical components.

# Fuses

## Standard Fuse Amperage Rating and Color

<b>Color</b>				
<b>Fuse rating</b>	<b>Micro fuses</b>	<b>Dual micro fuses</b>	<b>M-type fuses</b>	<b>J-type fuses</b>
5A	Tan	Tan	-	-
7.5A	Brown	Brown	-	-
10A	Red	Red	-	-
15A	Blue	Blue	Grey	-
20A	Yellow	-	Light Blue	Blue
25A	White	-	White	White
30A	Green	-	Pink	Pink
40A	-	-	Green	Green
50A	-	-	-	Red
60A	-	-	-	Yellow

# Maintenance

## GENERAL INFORMATION

Have your vehicle serviced regularly to help maintain its roadworthiness and resale value. There is a large network of Ford authorized dealers that are there to help you with their professional servicing expertise. We believe that their specially trained technicians are best qualified to service your vehicle properly and expertly. They are supported by a wide range of highly specialized tools developed specifically for servicing your vehicle.

To help you service your vehicle, we provide scheduled maintenance information which makes tracking routine service easy. See **Scheduled Maintenance** (page 371).

If your vehicle requires professional service, your authorized dealer can provide the necessary parts and service. Check your warranty information to find out which parts and services are covered.

Use only recommended fuels, lubricants, fluids and service parts conforming to specifications. Motorcraft® parts are designed and built to provide the best performance in your vehicle.

## Precautions

- Do not work on a hot engine.
- Make sure that nothing gets caught in moving parts.
- Do not work on a vehicle with the engine running in an enclosed space, unless you are sure you have enough ventilation.
- Keep all open flames and other burning material (such as cigarettes) away from the battery and all fuel related parts.

## Working with the Engine Off

1. Set the parking brake and shift to **P** (Park).
2. Turn off the engine and remove the key (if equipped).
3. Block the wheels.

## Working with the Engine On

### WARNING



To reduce the risk of vehicle damage and/or personal burn injuries, do not start your engine with the air cleaner removed and do not remove it while the engine is running.

1. Set the parking brake and shift to **P** (Park).
2. Block the wheels

## OPENING AND CLOSING THE HOOD

### Opening the Hood

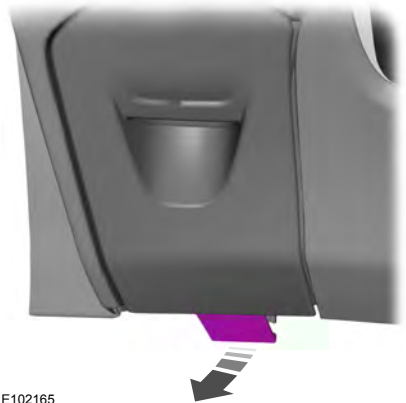

E102165

1. Pull the hood release handle.

# Maintenance

---



E163236

2. Move the catch to the left.



E87786

3. Open the hood and support it with the hood strut.



## Closing the Hood

1. Remove the hood strut from the catch and secure correctly after use.
2. Lower the hood and allow it to drop from under its own weight for the last 8 - 11 inches (20 - 30 centimeters).

**Note:** *Make sure that you have closed the hood correctly.*

# Maintenance

## UNDER HOOD OVERVIEW - 1.0L ECOBOOST™

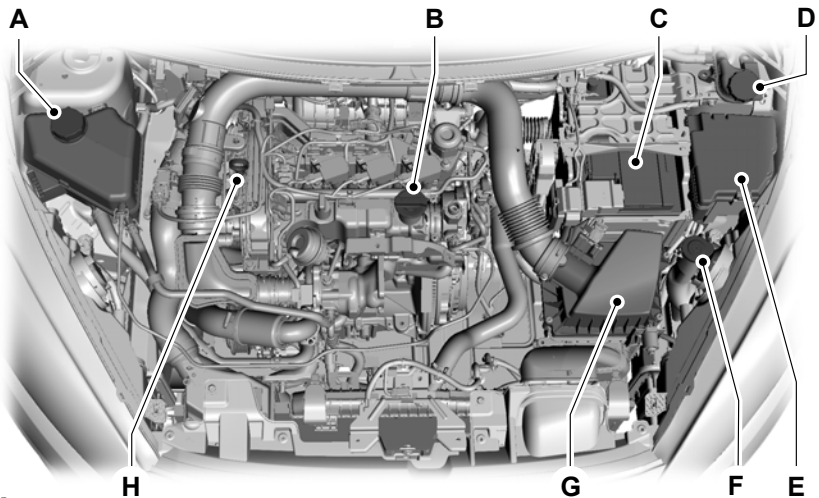

E163005

- A Engine coolant reservoir\*: See **Engine Coolant Check** (page 183).
- B Engine oil filler cap\*: See **Engine Oil Check** (page 182).
- C Battery: See **Changing the 12V Battery** (page 186).
- D Brake and clutch fluid reservoir\*: See **Brake Fluid Check** (page 185).
- E Engine compartment fuse box: See **Fuses** (page 169).
- F Windshield and rear window washer fluid reservoir: See **Washer Fluid Check** (page 186).
- G Air cleaner: See **Changing the Engine Air Filter** (page 187).
- H Engine oil dipstick\*: See **Engine Oil Check** (page 182).

\* The filler caps and the engine oil dipstick are colored for easy identification.

# Maintenance

## UNDER HOOD OVERVIEW - 1.6L DURATEC-16V TI-VCT (88KW/120PS) - SIGMA

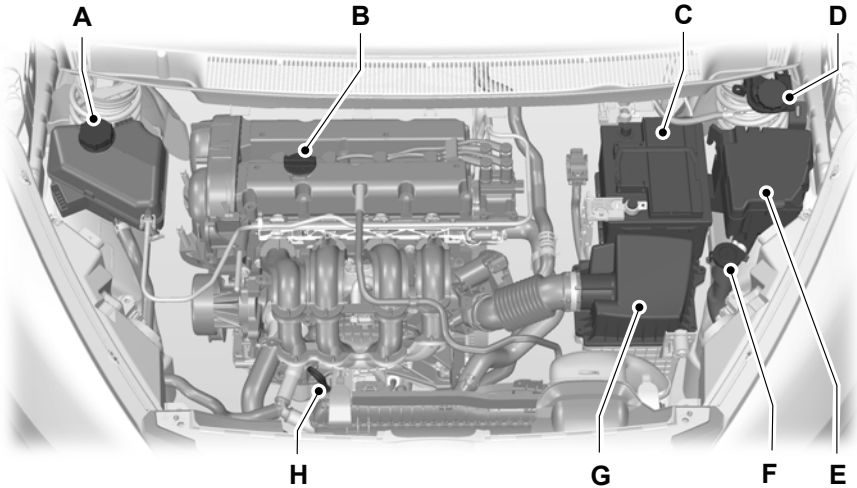

E163006

- A Engine coolant reservoir\*: See **Engine Coolant Check** (page 183).
- B Engine oil filler cap\*: See **Engine Oil Check** (page 182).
- C Battery: See **Changing the 12V Battery** (page 186).
- D Brake and clutch fluid reservoir : See **Brake Fluid Check** (page 185).
- E Engine compartment fuse box: See **Fuses** (page 169).
- F Windshield and rear window washer fluid reservoir: See **Washer Fluid Check** (page 186).
- G Air cleaner: See **Changing the Engine Air Filter** (page 187).
- H Engine oil dipstick\*: See **Engine Oil Check** (page 182).

\* The filler caps and the engine oil dipstick are colored for easy identification.

# Maintenance

## UNDER HOOD OVERVIEW - 1.6L ECOBOOST™

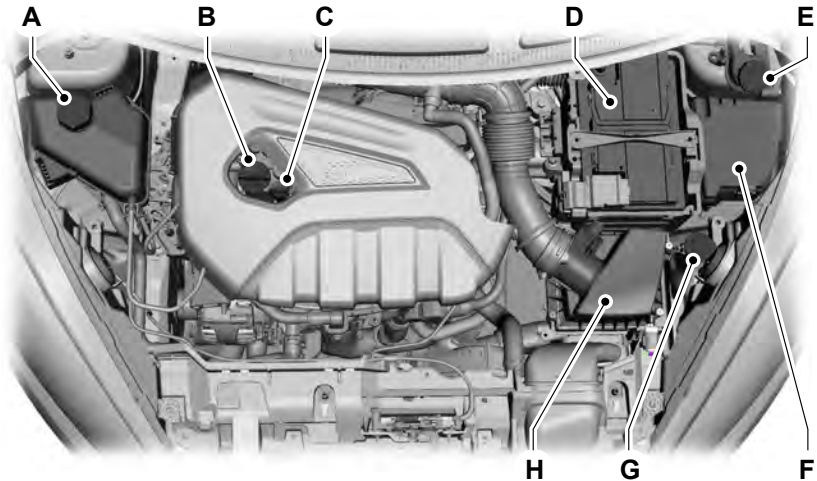

E163007

- A Engine coolant reservoir\*: See **Engine Coolant Check** (page 183).
- B Engine oil filler cap\*: See **Engine Oil Check** (page 182).
- C Engine oil dipstick\*: See **Engine Oil Check** (page 182).
- D Battery: See **Changing the 12V Battery** (page 186).
- E Brake and clutch fluid reservoir\*: See **Brake Fluid Check** (page 185).
- F Engine compartment fuse box: See **Fuses** (page 169).
- G Windshield and rear window washer fluid reservoir: See **Washer Fluid Check** (page 186).
- H Air cleaner: See **Changing the Engine Air Filter** (page 187).

\* The filler caps and the engine oil dipstick are colored for easy identification.



# Maintenance

## ENGINE OIL DIPSTICK - 1.0L ECOBOOST™

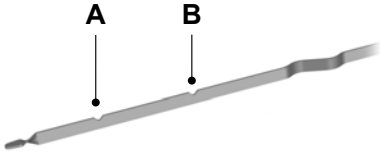

E141337

- A Minimum
- B Maximum

## ENGINE OIL DIPSTICK - 1.6L DURATEC-16V TI-VCT (88KW/120PS) - SIGMA

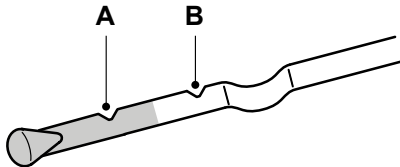

E95540

- A Minimum
- B Maximum

## ENGINE OIL DIPSTICK - 1.6L ECOBOOST™

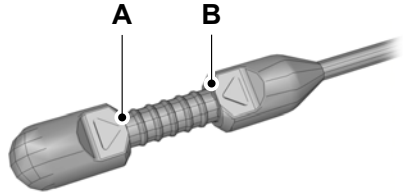

E134114

- A Minimum
- B Maximum

## ENGINE OIL CHECK

**Note:** Check the level before starting the engine.

**Note:** Make sure that the level is between the MIN and the MAX marks.

1. Make sure that your vehicle is on level ground.
2. Turn the engine off and wait 10 minutes for the oil to drain into the oil pan.
3. Remove the dipstick and wipe it with a clean, lint-free cloth. Replace the dipstick and remove it again to check the oil level.

If the level is at the MIN mark, add oil immediately.

## Adding Engine Oil

**Note:** Do not remove the filler cap when the engine is running.

**Note:** Do not add oil further than the MAX mark. Oil levels above the MAX mark may cause engine damage.

# Maintenance



E142732

Only use oils certified for gasoline engines by the American Petroleum Institute (API). An oil with this trademark symbol conforms to the current engine and emission system protection standards and fuel economy requirements of the International Lubricants Specification Advisory Council (ILSAC), comprised of U.S. and Japanese automobile manufacturers.

1. Remove the filler cap.
2. Add engine oil that meets the Ford specifications. See **Maintenance** (page 177).
3. Replace the filler cap. Turn it until you feel a strong resistance.

## Resetting the Oil Life Monitoring System

**Note:** Reset the oil life monitoring only after an oil change.

1. Turn the ignition key to the on position. Do not start the engine. For vehicles with push-button start, press and hold the start button for two seconds without pressing the brake pedal. Do not attempt to start the engine.
2. Press both the accelerator and brake pedals at the same time.
3. Keep both pedals fully pressed.

4. After three seconds, the Service: Oil reset in prog. message will be displayed.
5. After 25 seconds, the Service: Oil reset complete message will be displayed.
6. Release both the accelerator and brake pedals.
7. The Service: Oil reset complete message will no longer be displayed.
8. Rotate the key to the off position. For vehicles with push-button start, press the start button to turn the vehicle off completely.

## ENGINE COOLANT CHECK

### Checking the Engine Coolant

When the engine is cold, check the concentration and level of the engine coolant at the intervals listed in the scheduled maintenance information. See **Scheduled Maintenance** (page 371).

**Note:** Make sure that the level is between the MIN and MAX marks on the coolant reservoir.

**Note:** Coolant expands when it is hot. The level may extend beyond the MAX mark

**Note:** If the level is at the MIN mark, below the MIN mark, or empty, add coolant immediately. See **Adding Engine Coolant** in this chapter.

The coolant concentration should be maintained within 48% to 50%, which equates to a freeze point between  $-30^{\circ}\text{F}$  ( $-34^{\circ}\text{C}$ ) and  $-34^{\circ}\text{F}$  ( $-37^{\circ}\text{C}$ ).

**Note:** For best results, coolant concentration should be tested with a refractometer such as Rotunda tool 300-ROB75240 available from your authorized dealer. Ford does not recommend the use of hydrometers or coolant test strips for measuring coolant concentrations.

# Maintenance

**Note:** *Automotive fluids are not interchangeable. Do not use engine coolant or antifreeze or windshield washer fluid outside of its specified function and vehicle location.*

## Adding Engine Coolant

### WARNINGS



Do not add engine coolant when the engine is hot. Steam and scalding liquids released from a hot cooling system can burn you badly. Also, you can be burned if you spill coolant on hot engine parts.



Do not put engine coolant in the windshield washer fluid container. If sprayed on the windshield, engine coolant could make it difficult to see through the windshield.



To reduce the risk of personal injury, make sure the engine is cool before unscrewing the coolant pressure relief cap. The cooling system is under pressure; steam and hot liquid can come out forcefully when the cap is loosened slightly.



Do not add coolant further than the MAX mark.

**Note:** *Do not use stop leak pellets, cooling system sealants, or additives as they can cause damage to the engine cooling or heating systems. This damage would not be covered under your vehicle's warranty.*

**Note:** *During normal vehicle operation, the engine coolant may change color from orange to pink or light red. As long as the engine coolant is clear and uncontaminated, this color change does not indicate the engine coolant has degraded nor does it require the engine coolant to be drained, the system to be flushed, or the engine coolant to be replaced.*

- Do not mix different colors or types of coolant in your vehicle. Make sure the correct coolant is used. Mixing of engine coolants may harm your engine's cooling system. The use of an improper coolant may harm engine and cooling system components and may void the warranty. Use prediluted engine coolant meeting the Ford specification. See **Capacities and Specifications** (page 235).
- In case of emergency, a large amount of water without engine coolant may be added in order to reach a vehicle service location. In this instance, the cooling system must be drained, chemically cleaned with Motorcraft® Premium Cooling System Flush, and refilled with engine coolant as soon as possible. Water alone (without engine coolant) can cause engine damage from corrosion, overheating or freezing.
- Do not use alcohol, methanol, brine or any engine coolants mixed with alcohol or methanol antifreeze (coolant). Alcohol and other liquids can cause engine damage from overheating or freezing.
- Do not add extra inhibitors or additives to the coolant. These can be harmful and compromise the corrosion protection of the engine coolant.

Unscrew the cap slowly. Any pressure will escape as you unscrew the cap.

Add prediluted engine coolant meeting the Ford specification. See **Capacities and Specifications** (page 235).

Whenever coolant has been added, the coolant level in the coolant reservoir should be checked the next few times you drive the vehicle. If necessary, add enough prediluted engine coolant to bring the coolant level to the proper level.

# Maintenance

---

## Recycled Engine Coolant

Ford Motor Company does not recommend the use of recycled engine coolant since a Ford-approved recycling process is not yet available.

Used engine coolant should be disposed of in an appropriate manner. Follow your community's regulations and standards for recycling and disposing of automotive fluids.

## Severe Climates

If you drive in extremely cold climates:

- It may be necessary to have a Ford authorized dealer increase the coolant concentration above 50%.
- A coolant concentration of 60% will provide improved freeze point protection. Engine coolant concentrations above 60% will decrease the overheat protection characteristics of the engine coolant and may cause engine damage

If you drive in extremely hot climates:

- It may be necessary to have a Ford authorized dealer decrease the coolant concentration to 40%.
- A coolant concentration of 40% will provide improved overheat protection. Engine coolant concentrations below 40% will decrease the corrosion/freeze protection characteristics of the engine coolant and may cause engine damage.

Vehicles driven year-round in non-extreme climates should use prediluted engine coolant for optimum cooling system and engine protection.

## AUTOMATIC TRANSMISSION FLUID CHECK

**Note:** *Transmission fluid should be checked by an authorized dealer. If required, fluid should be added by an authorized dealer.*

The automatic transmission does not have a transmission fluid dipstick.

Have an authorized dealer check and change the transmission fluid and filter at the correct service interval. See **Scheduled Maintenance** (page 371). Your transmission does not consume fluid. However, the fluid level should be checked if the transmission is not working properly, (i.e., if the transmission slips or shifts slowly) or if you notice some sign of fluid leakage.

Do not use supplemental transmission fluid additives, treatments or cleaning agents. The use of these materials may affect transmission operation and result in damage to internal transmission components.

## BRAKE FLUID CHECK

Fluid levels between the MIN and MAX lines are within the normal operating range; there is no need to add fluid. If the fluid levels are outside of the normal operating range, the performance of the system could be compromised; seek service from your authorized dealer immediately.

## POWER STEERING FLUID CHECK

Your vehicle is equipped with an electric power steering (EPS) system. There is no fluid reservoir to check or fill.

# Maintenance

## FUEL FILTER

Your vehicle is equipped with a lifetime fuel filter that is integrated with the fuel tank. Regular maintenance or replacement is not needed.

## WASHER FLUID CHECK

**Note:** *The reservoir supplies the front and rear washer systems.*

When adding fluid, use a mixture of washer fluid and water to help prevent freezing in cold weather and improve the cleaning capability. We recommend that you use only high quality washer fluid.

For information on fluid dilution, refer to the product instructions.

## CHANGING THE 12V BATTERY

### WARNING



For vehicles with start-stop the battery requirement is different. You must replace the battery with one of exactly the same specification.

**Note:** *Where applicable you must reprogram the audio system using the keycode.*

The battery is located in the engine compartment. See **Maintenance** (page 177).

## CHECKING THE WIPER BLADES



E142463

Run the tip of your fingers over the edge of the blade to check for roughness.

Clean the wiper blades with washer fluid or water applied with a soft sponge or cloth.

## CHANGING THE WIPER BLADES

### Windshield Wiper Blades

#### Changing the Windshield Wiper Blades

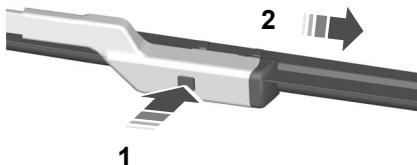

E72899

1. Press the locking button.
2. Remove the wiper blade.
3. Install in the reverse order.

**Note:** *Make sure that the wiper blade locks into place.*

### Rear Window Wiper Blade

1. Lift the wiper arm.

# Maintenance

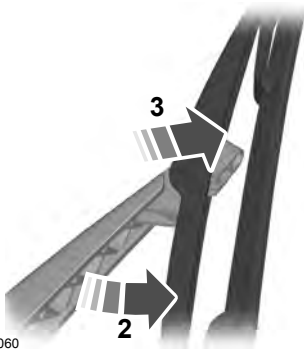

E130060

2. Slightly rotate the wiper blade from the wiper arm
3. Disengage the wiper blade from the wiper arm.
4. Remove the wiper blade.
5. Install in the reverse order.

**Note:** Make sure that the wiper blade locks into place.

## CHANGING THE ENGINE AIR FILTER

### WARNING



To reduce the risk of vehicle damage and personal burn injuries, do not start your engine with the air cleaner removed and do not remove it while the engine is running.

When changing the air filter element, use only the air filter element listed. See

**Technical Specifications** (page 236).

On vehicles with an EcoBoost engine, when servicing the air cleaner it is important that no foreign material enters the air induction system. The engine and turbocharger are susceptible to damage from even small particles.

Change the air filter element at the correct interval. See **Scheduled Maintenance** (page 371).

**Note:** Failure to use the correct air filter element may result in severe engine damage. Your warranty may be void for any damage to the engine if the correct air filter element is not used.

### Vehicles with 1.0L EcoBoost and 1.6L EcoBoost Engine

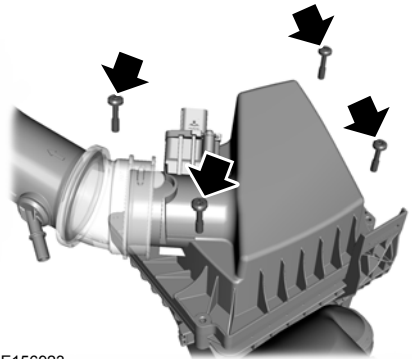

E156923

### Vehicles with 1.6L Duratec-16V Engine

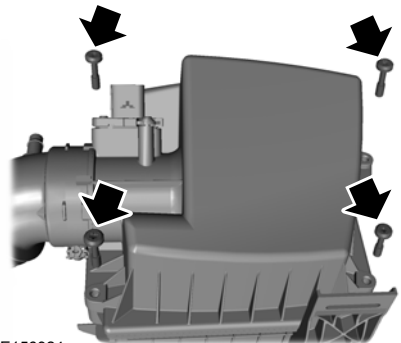

E156924

1. Remove the retaining screws that secure the air filter housing cover.
2. Carefully lift the air filter housing cover.

# Maintenance

3. Remove the air filter element from the air filter housing.
4. Wipe any dirt or debris from the air filter housing and cover to make sure no dirt gets in the engine and to make sure you have a good seal.
5. Install a new air filter element. Be careful not to crimp the filter element edges between the air filter housing and cover. This could cause filter damage and allow unfiltered air to enter the engine if not correctly seated.
6. Install the air filter housing cover.
7. Install the retaining screws to secure the air filter housing cover to the air filter housing.

## ADJUSTING THE HEADLAMPS

### Vertical Aim Adjustment

If your vehicle has been involved in an accident, have the alignment of your headlamps checked by an authorized dealer.

### Headlamp Aiming Target

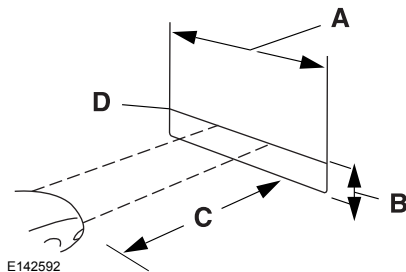

- A 8 feet (2.4 meters)
- B Center height of lamp to ground
- C 25 feet (7.6 meters)
- D Horizontal reference line

### Vertical Aim Adjustment Procedure

1. Park your vehicle directly in front of a wall or screen on a level surface, approximately 25 feet (7.6 meters) away.
2. Measure the height of the headlamp bulb center from the ground and mark an 8 foot (2.4 meter) horizontal reference line on the vertical wall or screen at this height.

**Note:** To see a clearer light pattern for adjusting, you may want to block the light from one headlamp while adjusting the other.

3. Turn on the low beam headlamps to illuminate the wall or screen and open the hood.

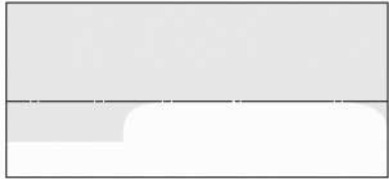

E142465

4. On the wall or screen you will observe a flat zone of high intensity light located at the top of the right hand portion of the beam pattern. If the top edge of the high intensity light zone is not at the horizontal reference line, adjust the headlamp.

# Maintenance

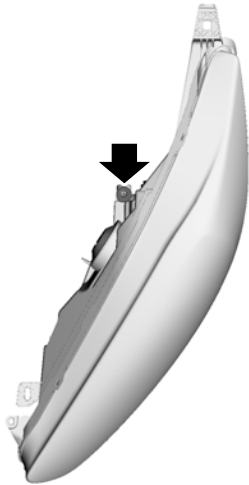

E156848

5. Locate the vertical adjuster on each headlamp. Using a Phillips #2 screwdriver, turn the adjuster either clockwise or counterclockwise in order to adjust the vertical aim of the headlamp. The horizontal edge of the brighter light should touch the horizontal reference line.
6. Close the hood and turn the lamps off.

## Horizontal Aim Adjustment

Horizontal aim is not required for this vehicle and is not adjustable.

## REMOVING A HEADLAMP

1. Open the hood. See **Opening and Closing the Hood** (page 177).

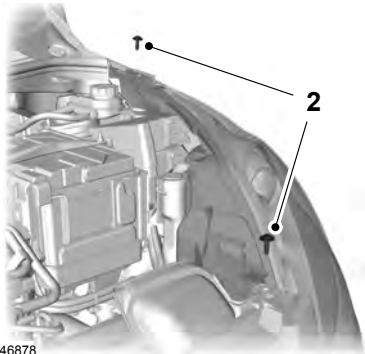

E146878

2. Remove the screws.

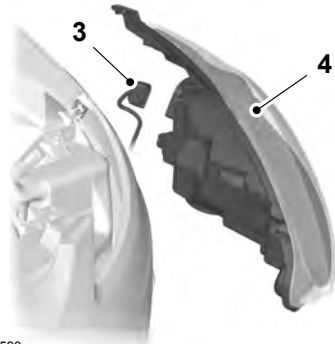

E102590

3. Disconnect the electrical connector.
4. Remove the headlamp.

**Note:** When fitting the headlamp, make sure that you reconnect the electrical connector correctly.

**Note:** When fitting the headlamp, make sure that you fully engage the headlamp in the retaining clips.



# Maintenance

## CHANGING A BULB

### WARNINGS



Switch the lamps and the ignition off.



Let the bulb cool down before removing it.



Do not touch the glass of the bulb.

**Note:** Only fit bulbs of the correct specification.

**Note:** The following instructions describe how to remove the bulbs. Fit replacements in the reverse order unless otherwise stated.

### Headlamp

**Note:** Remove the covers to gain access to the bulbs.

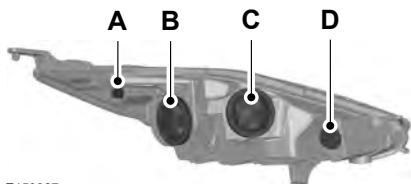

E159827

- A Side marker
- B Headlamp low beam
- C Headlamp high beam
- D Direction indicator

### Side Marker

1. Remove the headlamp. See **Removing a Headlamp** (page 189).

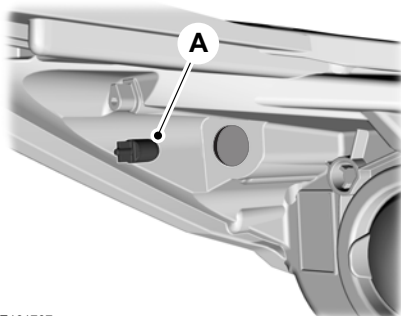

E161707

2. Remove the bulb holder.
3. Remove the bulb.

### Headlamp Low Beam

1. Remove the headlamp. See **Removing a Headlamp** (page 189).

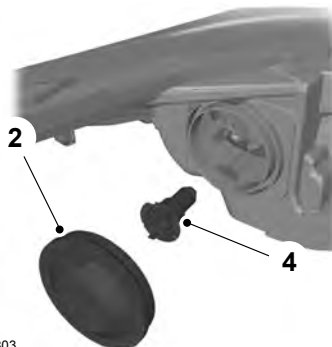

E146803

2. Remove the cover.
3. Disconnect the electrical connector.
4. Release the clip and remove the bulb.

**Note:** Do not touch the glass of the bulb.

### Headlamp High Beam

1. Remove the headlamp. See **Removing a Headlamp** (page 189).

# Maintenance

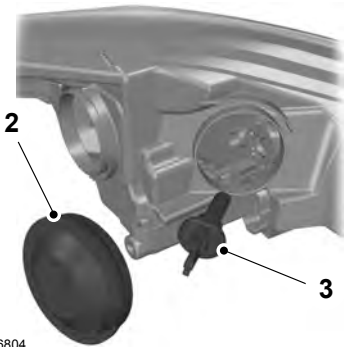

E146804

2. Remove the cover.
3. Turn the bulb counterclockwise and remove it.

**Note:** Do not touch the glass of the bulb.

## Direction Indicator

1. Remove the headlamp. See **Removing a Headlamp** (page 189).



E146805

2. Turn the bulb holder counterclockwise and remove it.
3. Gently press the bulb into the bulb holder, turn it counterclockwise and remove it.

## Side Direction Indicator

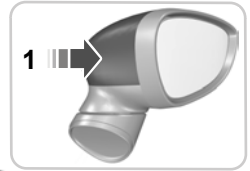

E112777

1. Press the side of the cover to release the clips.
2. Remove the cover.

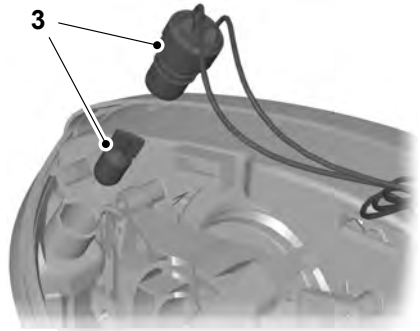

E112778

3. Remove the bulb and bulb holder. Remove the bulb.

# Maintenance

## Front Fog Lamps

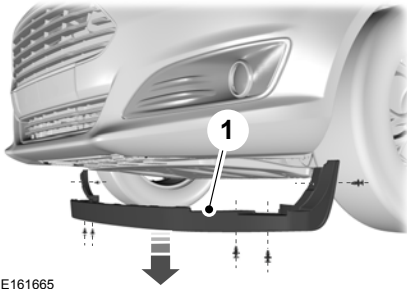

E161665

1. Remove the retaining clips to gain access to the lamp assembly.

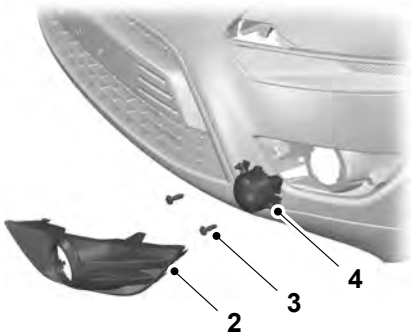

E161667

**Note:** You cannot separate the fog lamp bulb from the bulb holder.

2. Using a suitable implement, remove the cover.
3. Remove the screws.
4. Remove the lamp.

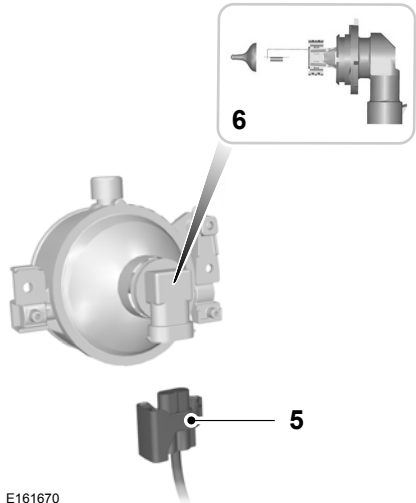

E161670

5. Disconnect the electrical connector.
6. Turn the bulb holder counterclockwise and remove it.

## Rear Lamps

### Brake, Tail and Direction Indicator Lamps

1. Remove the trim and disconnect the electrical connector.
2. Loosen the wing nut and carefully pull out the rear lamp.

# Maintenance

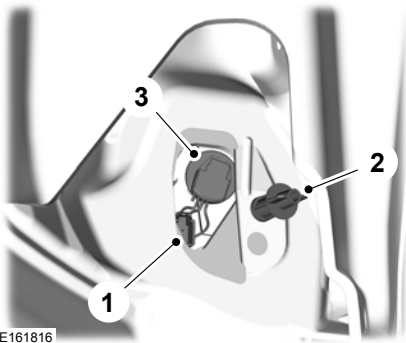

E161816

3. Unclip the bulb holder and remove it.
4. Remove the bulb.

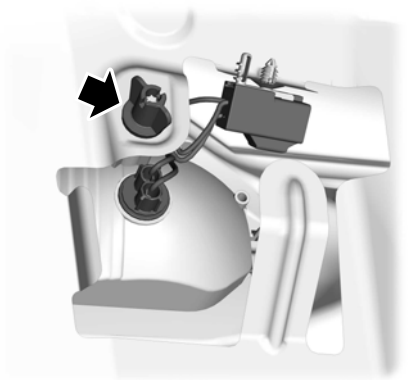

E161817

2. Loosen the wing nut and carefully pull out the rear lamp.

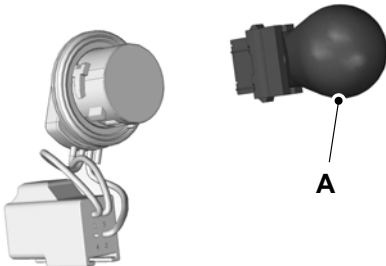

E161793

## Reversing Lamp

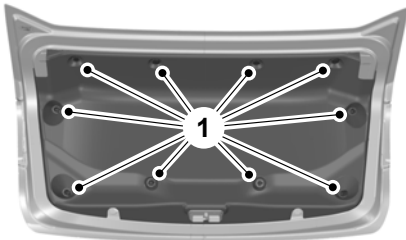

E113384

1. Remove the trim panel and disconnect the electrical connector.

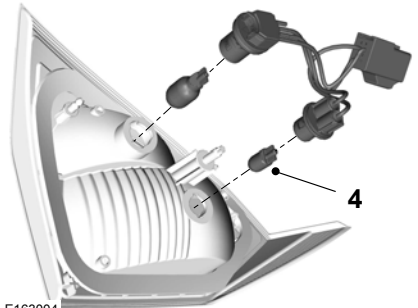

E163004

3. Turn the bulb holder counterclockwise and remove it.
4. Remove the bulb.

## Center High Mounted Stop Lamp

**Note:** The LED board is not a serviceable item, please consult your dealer if this fails.

# Maintenance

## License Plate Lamp

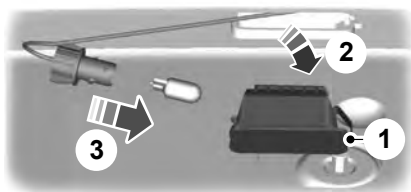

E72789

1. Carefully release the spring clip.
2. Remove the lamp.
3. Turn the bulb counterclockwise and remove it.

## Interior Lamp

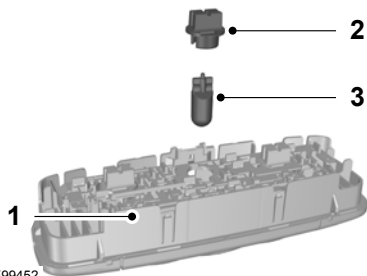

E99452

1. Carefully remove the lamp.
2. Turn the bulb holder counterclockwise and remove it.
3. Remove the bulb.

## Reading Lamps

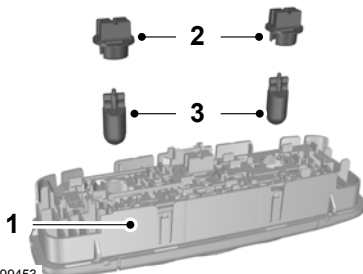

E99453

1. Carefully remove the lamp.
2. Turn the bulb holder counterclockwise and remove it.
3. Remove the bulb.

## Luggage Compartment Lamp, Footwell Lamp and Liftgate Lamp

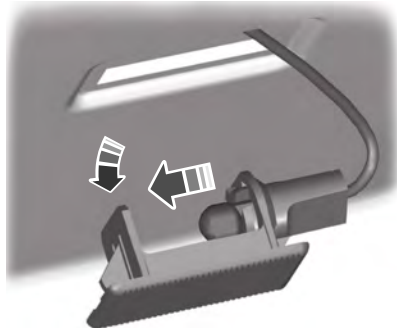

E72784

1. Carefully pry out the lamp.
2. Remove the bulb.

## CHANGING A BULB

### WARNINGS



Switch the lamps and the ignition off.

# Maintenance

## WARNINGS



Let the bulb cool down before removing it.



Do not touch the glass of the bulb.

**Note:** Only fit bulbs of the correct specification.

**Note:** The following instructions describe how to remove the bulbs. Fit replacements in the reverse order unless otherwise stated.

## Headlamp

**Note:** Remove the covers to gain access to the bulbs.

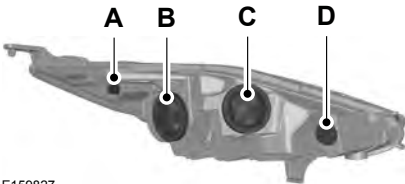

E159827

- A Side marker
- B Headlamp low beam
- C Headlamp high beam
- D Direction indicator

## Side Marker

1. Remove the headlamp. See **Removing a Headlamp** (page 189).

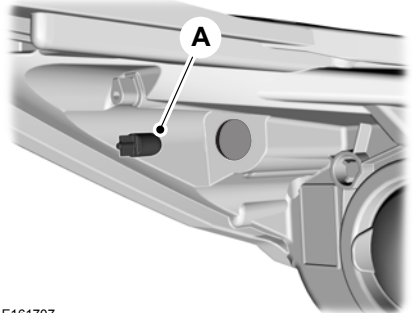

E161707

2. Remove the bulb holder.
3. Remove the bulb.

## Headlamp Low Beam

1. Remove the headlamp. See **Removing a Headlamp** (page 189).



E146803

2. Remove the cover.
3. Disconnect the electrical connector.
4. Release the clip and remove the bulb.

**Note:** Do not touch the glass of the bulb.

## Headlamp High Beam

1. Remove the headlamp. See **Removing a Headlamp** (page 189).

# Maintenance

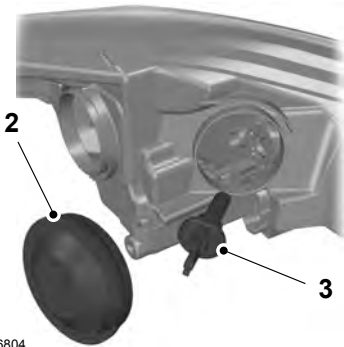

E146804

2. Remove the cover.
3. Turn the bulb counterclockwise and remove it.

**Note:** Do not touch the glass of the bulb.

## Direction Indicator

1. Remove the headlamp. See **Removing a Headlamp** (page 189).



E146805

2. Turn the bulb holder counterclockwise and remove it.
3. Gently press the bulb into the bulb holder, turn it counterclockwise and remove it.

## Side Direction Indicator

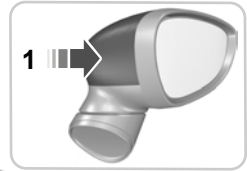

E112777

1. Press the side of the cover to release the clips.
2. Remove the cover.

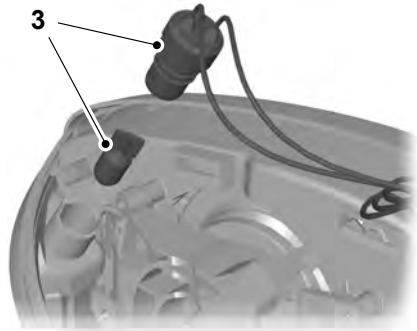

E112778

3. Remove the bulb and bulb holder. Remove the bulb.

# Maintenance

## Front Fog Lamps

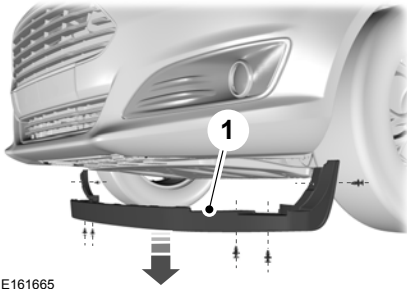

E161665

1. Remove the retaining clips to gain access to the lamp assembly.

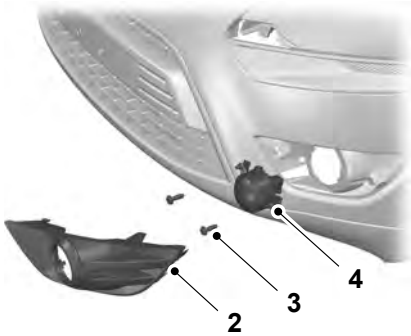

E161667

**Note:** You cannot separate the fog lamp bulb from the bulb holder.

2. Using a suitable implement, remove the cover.
3. Remove the screws.
4. Remove the lamp.

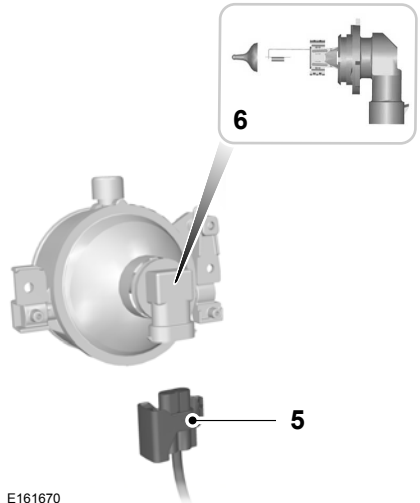

E161670

5. Disconnect the electrical connector.
6. Turn the bulb holder counterclockwise and remove it.

## Rear Lamps

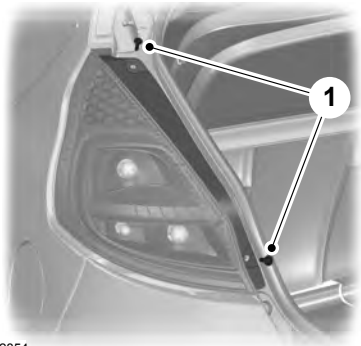

E102854

1. Remove the screws.



# Maintenance

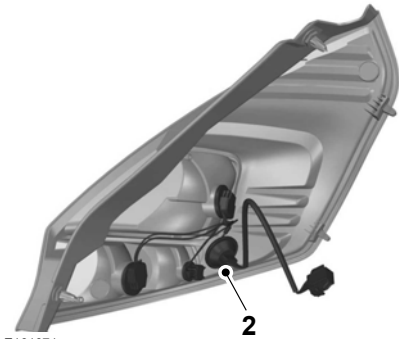

2. Disconnect the electrical connector.
3. Turn the bulb holder counterclockwise and remove it.

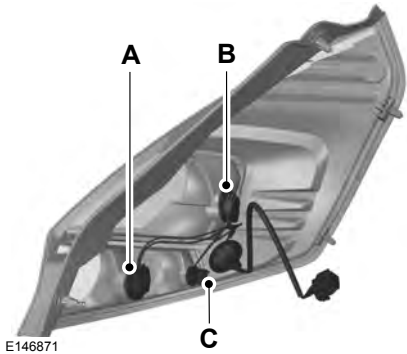

4. Gently press the bulb into the bulb holder, turn it counterclockwise and remove it.
- A. Indicator  
B. Tail and brake  
C. Reverse

## Center High Mounted Stop Lamp

**Note:** The LED board is not a serviceable item, please consult your dealer if this fails.

## License Plate Lamp

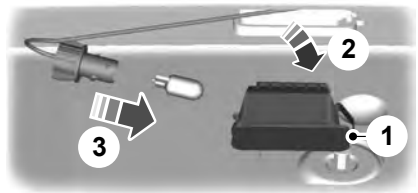

1. Carefully release the spring clip.
2. Remove the lamp.
3. Turn the bulb holder counterclockwise and remove it.

## Interior Lamp

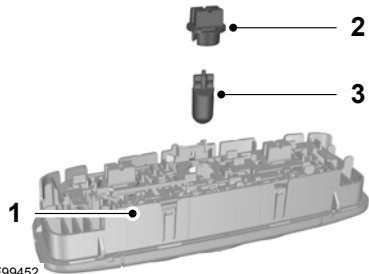

1. Carefully remove the lamp.
2. Turn the bulb holder counterclockwise and remove it.
3. Remove the bulb.

# Maintenance

## Reading Lamps

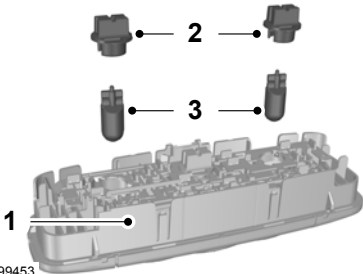

E99453

1. Carefully remove the lamp.
2. Turn the bulb holder counterclockwise and remove it.
3. Remove the bulb.

## Luggage Compartment Lamp, Footwell Lamp and Liftgate Lamp

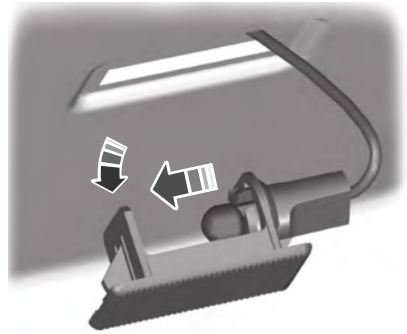

E72784

1. Carefully pry out the lamp.
2. Remove the bulb.

## BULB SPECIFICATION CHART

Lamp	Specification	Power (watt)
Front direction indicator	PY27/7	27/7
Headlamp high beam	H1LL	55
Headlamp low beam	H11	55
Front fog lamp	H11	55
Side direction indicator	WY5W	5
Rear direction indicator	PY27/7	27/7
Brake and tail lamp	PY27/7	27/7
Reversing lamp	W16W	16
License plate lamp	W5W	5
Interior lamp	W6W	6
Reading lamp	W5W	5
Luggage compartment lamp	W5W	5

# Maintenance

**Note:** On some vehicles the lamps are LED. These are not serviceable items, have your vehicle checked by an authorized dealer as soon as possible.

## TECHNICAL SPECIFICATIONS - 1.0L ECOBOOST™

### Capacities

Item	Capacity
Engine cooling system	6.1 qt (5.8 L)
Engine lubrication system - including the oil filter	4.3 qt (4.1 L)
Engine lubrication system - excluding the oil filter	4.2 qt (4.0 L)
Engine oil top-up - raise the level on the dipstick from minimum to maximum	0.8 qt (0.75 L)
Fuel tank	12.4 gal (47 L)
Automatic transmission	1.8 qt (1.7 L)
Windshield and rear window washer system - including headlamp washer	2.6 qt (2.5 L)

### Specifications

#### Materials

Name	Specification
Motorcraft® SAE 5W-20 Premium Synthetic Blend Motor Oil or Motorcraft® SAE 5W-20 Full Synthetic Motor Oil XO-5W20-QSP, XO-5W20-QFS	WSS-M2C945-A
Motorcraft® Dual Clutch Transmission Fluid XT-11-QDC	WSS-M2C200-D2
Motorcraft® Full Synthetic Manual Transmission Fluid XT-M5-QS	WSD-M2C200-C
Motorcraft® Orange Antifreeze/Coolant Prediluted VC-3DIL-B	WSS-M97B44-D2
Motorcraft® DOT 4 LV High Performance Motor Vehicle Brake Fluid PM-20	WSS-M6C65-A2
Motorcraft® Multi-Purpose Grease Spray XL-5	ESB-MIC93-B

# Maintenance

Use oil and fluids that meet the defined specification and viscosity grades.

**Note:** *If you unable to find an engine oil that meets the specification defined by WSS-M2C913-D, you must use an SAE 5W-30 engine oil defined by ACEA A5/B5 for top-up only.*

If you use oil and fluids that do not meet the defined specification and viscosity grades this may lead to:

- component damage which may not be covered by the vehicle Warranty.
- longer engine cranking periods.
- increased emission levels.
- reduced engine performance.
- reduced fuel economy.

## TECHNICAL SPECIFICATIONS - 1.6L ECOBOOST™

### Capacities

Item	Capacity
Engine cooling system	6.1 qt (5.8 L)
Engine lubrication system - including the oil filter	4.3 qt (4.1 L)
Engine lubrication system - excluding the oil filter	4 qt (3.8 L)
Engine oil top-up - raise the level on the dipstick from minimum to maximum	0.8 qt (0.75 L)
Fuel tank	12.4 gal (47 L)
Automatic transmission	1.8 qt (1.7 L)
Windshield and rear window washer system - including headlamp washer	2.6 qt (2.5 L)

### Specifications

#### Materials

Name	Specification
Motorcraft® SAE 5W-20 Premium Synthetic Blend Motor Oil or Motorcraft® SAE 5W-20 Full Synthetic Motor Oil XO-5W20-QSP, XO-5W20-QFS	WSS-M2C945-A
Motorcraft® Dual Clutch Transmission Fluid XT-11-QDC	WSS-M2C200-D2
Motorcraft® Full Synthetic Manual Transmission Fluid XT-M5-QS	WSD-M2C200-C
Motorcraft® Orange Antifreeze/Coolant Prediluted VC-3DIL-B	WSS-M97B44-D2

# Maintenance

Name	Specification
Motorcraft® DOT 4 LV High Performance Motor Vehicle Brake Fluid PM-20	WSS-M6C65-A2
Motorcraft® Multi-Purpose Grease Spray XL-5	ESB-MIC93-B

Use oil and fluids that meet the defined specification and viscosity grades.

**Note:** *If you unable to find an engine oil that meets the specification defined, you must use an SAE 5W-30 engine oil defined by ACEA A5/B5 for top-up only.*

If you use oil and fluids that do not meet the defined specification and viscosity grades this may lead to:

- component damage which may not be covered by the vehicle Warranty.
- longer engine cranking periods.
- increased emission levels.
- reduced engine performance.
- reduced fuel economy.

## TECHNICAL SPECIFICATIONS - 1.6L DURATEC-16V TI-VCT (SIGMA)

### Capacities

Item	Capacity
Engine cooling system	6.1 qt (5.8 L)
Engine lubrication system - including the oil filter	4.3 qt (4.1 L)
Engine lubrication system - excluding the oil filter	4 qt (3.8 L)
Engine oil top-up - raise the level on the dipstick from minimum to maximum	0.8 qt (0.75 L)
Fuel tank	12.4 gal (47 L)
Automatic transmission	1.8 qt (1.7 L)
Manual transmission	2.2 qt (2.1 L)
Windshield and rear window washer system - including headlamp washer	2.6 qt (2.5 L)

# Maintenance

## Specifications

### Materials

Name	Specification
Motorcraft® SAE 5W-20 Premium Synthetic Blend Motor Oil or Motorcraft® SAE 5W-20 Full Synthetic Motor Oil XO-5W20-QSP, XO-5W20-QFS	WSS-M2C945-A
Motorcraft® Dual Clutch Transmission Fluid XT-11-QDC	WSS-M2C200-D2
Motorcraft® Full Synthetic Manual Transmission Fluid XT-M5-QS	WSD-M2C200-C
Motorcraft® Orange Antifreeze/Coolant Prediluted VC-3DIL-B	WSS-M97B44-D2
Motorcraft® DOT 4 LV High Performance Motor Vehicle Brake Fluid PM-20	WSS-M6C65-A2
Motorcraft® Multi-Purpose Grease Spray XL-5	ESB-MIC93-B

Use oil and fluids that meet the defined specification and viscosity grades.

**Note:** *If you unable to find an engine oil that meets the specification defined by WSS-M2C913-D, you must use an SAE 5W-30 engine oil defined by ACEA A5/B5 for top-up only.*

If you use oil and fluids that do not meet the defined specification and viscosity grades this may lead to:

- component damage which may not be covered by the vehicle Warranty.
- longer engine cranking periods.
- increased emission levels.
- reduced engine performance.
- reduced fuel economy.

# Vehicle Care

---

## CLEANING PRODUCTS

For best results, use the following products or products of equivalent quality:

Motorcraft Bug and Tar Remover (ZC-42)

Motorcraft Custom Bright Metal Cleaner (ZC-15)

Motorcraft Detail Wash (ZC-3-A)

Motorcraft Dusting Cloth (ZC-24)

Motorcraft Engine Shampoo and Degreaser (U.S. only) (ZC-20)

Motorcraft Engine Shampoo (Canada only) (CXC-66-A)

Motorcraft Multi-Purpose Cleaner (Canada only) (CXC-101)

Motorcraft Premium Glass Cleaner (Canada only) (CXC-100)

Motorcraft Premium Quality Windshield Washer Fluid (Canada only) [CXC-37-(A, B, D or F)]

Motorcraft Premium Windshield Wash Concentrate with Bitterant (U.S. only) (ZC-32-B1)

Motorcraft Professional Strength Carpet & Upholstery Cleaner (ZC-54)

Motorcraft Spot and Stain Remover (U.S. only) (ZC-14)

Motorcraft Ultra-Clear Spray Glass Cleaner (ZC-23)

Motorcraft Wheel and Tire Cleaner (ZC-37-A)

## CLEANING THE EXTERIOR

Wash your vehicle regularly with cool or lukewarm water and a neutral pH shampoo, such as Motorcraft Detail Wash.

- Never use strong household detergents or soap, such as dish washing or laundry liquid. These products can discolor and spot painted surfaces.
- Never wash a vehicle that is “hot to the touch” or during exposure to strong, direct sunlight.
- Dry your vehicle with a chamois or soft terry cloth towel in order to eliminate water spotting.
- Immediately remove items such as gasoline, diesel fuel, bird droppings and insect deposits because they can cause damage to your vehicle’s paintwork and trim over time. Use Motorcraft Bug and Tar Remover.
- Remove any exterior accessories, such as antennas, before entering a car wash.

**Note:** *Suntan lotions and insect repellents can damage any painted surface; if these substances come in contact with your vehicle, wash off as soon as possible.*

## Stripes or Graphics (if equipped)

Do not use a commercial or high-pressure sprayer on the surface or edge of stripes and graphics. This can cause damage to the film and cause the edge of the film to peel away from the vehicle surface.

## Exterior Chrome

**Note:** *Never use abrasive materials such as steel wool or plastic pads as they can scratch the chrome surface.*

**Note:** *Do not use chrome cleaner, metal cleaner or polish on wheels and wheel covers*

# Vehicle Care

---

- Wash your vehicle first, using cool or lukewarm water and a neutral pH shampoo, such as Motorcraft Detail Wash.
- Use Motorcraft Custom Bright Metal Cleaner. Apply the product as you would a wax to clean bumpers and other chrome parts; allow the cleaner to dry for a few minutes, then wipe off the haze with a clean, dry rag.
- Do not apply cleaning product to hot surfaces and do not leave cleaning product on chrome surfaces longer than the time recommended.
- Using other non-recommended cleaners can result in severe and permanent cosmetic damage.
- Use a quality wax that does not contain abrasives.
- Follow the manufacturer's instructions to apply and remove the wax.
- Apply a small amount of wax in a back-and-forth motion, not in circles.
- Do not allow wax to come in contact with any non-body (low-gloss black) colored trim. The wax will discolor or stain the parts over time.
  - Roof racks.
  - Bumpers.
  - Grained door handles.
  - Side moldings.
  - Mirror housings.
  - Windshield cowl area.

## Underbody

Flush the complete underside of your vehicle frequently. Keep body and door drain holes free from packed dirt.

## Cleaning Plastic Exterior Parts

Use only approved products to clean plastic parts

- For routine cleaning, use Motorcraft Detail Wash.
- If tar or grease spots are present, use Motorcraft Bug and Tar Remover.

## WAXING

Regular waxing is necessary to protect your car's paint from the elements. We recommend that you wash and wax the painted surface once or twice a year.

When washing and waxing, park your vehicle in a shaded area out of direct sunlight. Always wash your vehicle before applying wax.

- Do not apply wax to glass areas.
- After waxing, your car's paint should feel smooth, and be free of streaks and smudges.

## CLEANING THE ENGINE

Engines are more efficient when they are clean because grease and dirt buildup keep the engine warmer than normal.

When washing:

- Take care when using a power washer to clean the engine. The high-pressure fluid could penetrate the sealed parts and cause damage.
- Do not spray a hot engine with cold water to avoid cracking the engine block or other engine components.
- Spray Motorcraft Engine Shampoo and Degreaser on all parts that require cleaning and pressure rinse clean. In Canada, use Motorcraft Engine Shampoo.
- Never wash or rinse the engine while it is hot or running; water in the running engine may cause internal damage.



# Vehicle Care

- Never wash or rinse any ignition coil, spark plug wire or spark plug well, or the area in and around these locations.
- Cover the battery, power distribution box, and air filter assembly to prevent water damage when cleaning the engine.

## CLEANING THE WINDOWS AND WIPER BLADES

Car wash chemicals and environmental fallout can result in windshield and wiper blade contamination. Dirty windshield and wipers will result in poor windshield wiper operation. Keep the windshield and wiper blades clean to maintain windshield wiper performance.

To clean the windshield and wiper blades:

- Clean the windshield with a non-abrasive glass cleaner.
- For windshields contaminated with tree sap, chemicals, wax or bugs, clean the entire windshield using steel wool (no greater than 0000 grade) in a circular motion and rinse with water.
- Clean the wiper blades with isopropyl rubbing alcohol or windshield washer fluid.

**Note:** Do not use razor blades or other sharp objects to clean or remove decals from the inside of the heated rear window. The vehicle warranty does not cover damage caused to the heated rear window grid lines.

## CLEANING THE INTERIOR

### WARNINGS



Do not use cleaning solvents, bleach or dye on the vehicle's safety belts, as these actions may weaken the belt webbing.

### WARNINGS



On vehicles equipped with seat-mounted airbags, do not use chemical solvents or strong detergents. Such products could contaminate the side airbag system and affect performance of the side airbag in a collision.

For fabric, carpets, cloth seats, safety belts and seats equipped with side airbags:

- Remove dust and loose dirt with a vacuum cleaner.
- Remove light stains and soil with Motorcraft Professional Strength Carpet & Upholstery Cleaner.
- If grease or tar is present on the material, spot-clean the area first with Motorcraft Spot and Stain Remover. In Canada, use Motorcraft Multi-Purpose Cleaner.
- If a ring forms on the fabric after spot cleaning, clean the entire area immediately (but do not oversaturate) or the ring will set.
- Do not use household cleaning products or glass cleaners, which can stain and discolor the fabric and affect the flame retardant abilities of the seat materials.

## REPAIRING MINOR PAINT DAMAGE

You should repair paintwork damage caused by stones from the road or minor scratches as soon as possible. A choice of products are available from an authorized dealer.

Remove particles such as bird droppings, tree sap, insect deposits, tar spots, road salt and industrial fallout before repairing paint chips.

# Vehicle Care

Always read and follow the manufacturer's instructions before using the products.

## CLEANING THE INSTRUMENT PANEL AND INSTRUMENT CLUSTER LENS

### WARNING



Do not use chemical solvents or strong detergents when cleaning the steering wheel or instrument panel to avoid contamination of the airbag system.

Clean the instrument panel and cluster lens with a clean, damp, white cotton cloth, then use a clean and dry white cotton cloth to dry these areas.

- Avoid cleaners or polishes that increase the gloss of the upper portion of the instrument panel. The dull finish in this area helps protect you from undesirable windshield reflection.
- Be certain to wash or wipe your hands clean if you have been in contact with certain products such as insect repellent and suntan lotion in order to avoid possible damage to the interior painted surfaces.
- Do not use household or glass cleaners as these may damage the finish of the instrument panel, interior trim and cluster lens.
- Do not allow air fresheners and hand sanitizers to spill onto interior surfaces. If a spill occurs, wipe off immediately. Damage may not be covered by your warranty.

If a staining liquid like coffee or juice has been spilled on the instrument panel or on interior trim surfaces, clean as follows:

1. Wipe up spilled liquid using a clean, white, cotton cloth.
2. Wipe the surface with a damp, clean, white cotton cloth. For more thorough cleaning, use a mild soap and water solution. If the spot cannot be completely cleaned by this method, the area may be cleaned using a commercially available cleaning product designed for automotive interiors.
3. If necessary, apply more soap and water solution or cleaning product to a clean, white, cotton cloth and press the cloth onto the soiled area. Allow this to set at room temperature for 30 minutes.
4. Remove the soaked cloth and if it is not soiled badly, use this cloth to clean the area by using a rubbing motion for 60 seconds.
5. Following this, wipe area dry with a clean, white, cotton cloth.

## CLEANING LEATHER SEATS (IF EQUIPPED)

For routine cleaning, wipe the surface with a soft, damp cloth. For more thorough cleaning, wipe the surface with a mild soap and water solution. Dry the area with a soft cloth.

If you cannot completely clean the leather using a mild soap and water solution, you can try a commercially available leather cleaning product designed for automotive interiors.

**Note:** To check for compatibility, first test any cleaner or stain remover on an inconspicuous part of the leather.

You should:

# Vehicle Care

---

- remove dust and loose dirt with a vacuum cleaner
- clean spills and stains as quickly as possible
- check for compatibility by first testing any cleaner or stain remover on an inconspicuous part of the leather.

Do not use the following products as these may damage the leather:

- oil/petroleum-based leather conditioners
- household cleaners
- alcohol solutions
- solvents or cleaners intended specifically for rubber, vinyl and plastics.

## CLEANING THE ALLOY WHEELS

**Note:** Do not apply a cleaning chemical to warm or hot wheel rims and covers.

**Note:** Industrial-strength (heavy-duty) cleaners, or cleaning chemicals, in combination with brush agitation to remove brake dust and dirt, could wear away the clear coat finish over a period of time.

**Note:** Do not use hydrofluoric acid-based or high caustic-based wheel cleaners, steel wool, fuels or strong household detergent.

**Note:** If you intend parking your vehicle for an extended period after cleaning the wheels with a wheel cleaner, drive your vehicle for a few minutes before doing so. This will reduce the risk of increased corrosion of the brake discs, brake pads and linings.

**Note:** Some automatic car washes may cause damage to the finish on your wheel rims and covers.

Alloy wheels and wheel covers are coated with a clear coat paint finish. To maintain their condition we recommend that you:

- Clean them weekly with the recommended wheel and tire cleaner.
- Use a sponge to remove heavy deposits of dirt and brake dust accumulation.
- Rinse them thoroughly with a pressurized stream of water when you have completed the cleaning process.

We recommend that you use Ford service wheel cleaner. Make sure that you read and follow the manufacturer's instructions.

Using other non-recommended cleaning products can result in severe and permanent cosmetic damage.

## VEHICLE STORAGE

If you plan on storing your vehicle for an extended period of time (30 days or more), read the following maintenance recommendations to make sure your vehicle stays in good operating condition.

All motor vehicles and their components were engineered and tested for reliable, regular driving. Long term storage under various conditions may lead to component degradation or failure unless specific precautions are taken to preserve the components.

### General

- Store all vehicles in a dry, ventilated place.
- Protect from sunlight, if possible.
- If vehicles are stored outside, they require regular maintenance to protect against rust and damage.

# Vehicle Care

---

## Body

- Wash your vehicle thoroughly to remove dirt, grease, oil, tar or mud from exterior surfaces, rear-wheel housing and underside of front fenders.
- Periodically wash your vehicle stored in exposed locations.
- Touch-up exposed or primed metal to prevent rust.
- Cover chrome and stainless steel parts with a thick coat of auto wax to prevent discoloration. Re-wax as necessary when your vehicle is washed.
- Lubricate all hood, door and trunk lid hinges, and latches with a light grade oil.
- Cover interior trim to prevent fading.
- Keep all rubber parts free from oil and solvents.

## Engine

- The engine oil and filter should be changed prior to storage, as used engine oil contain contaminants that may cause engine damage.
- Start the engine every 15 days. Run at fast idle until it reaches normal operating temperature
- With your foot on the brake, shift through all the gears while the engine is running.

## Fuel system

- Fill the fuel tank with high-quality fuel until the first automatic shutoff of the fuel pump nozzle.

## Cooling system

- Protect against freezing temperatures.
- When removing your vehicle from storage, check coolant fluid level. Confirm there are no cooling system leaks, and fluid is at the recommended level.

## Battery

- Check and recharge as necessary. Keep connections clean.
- If storing your vehicle for more than 30 days without recharging the battery, it may be advisable to disconnect the battery cables to ensure battery charge is maintained for quick starting.

**Note:** *If battery cables are disconnected, it will be necessary to reset memory features.*

## Brakes

- Make sure brakes and parking brake are fully released.

## Tires

- Maintain recommended air pressure.

## Miscellaneous

- Make sure all linkages, cables, levers and pins under your vehicle are covered with grease to prevent rust.
- Move vehicles at least 25 feet (8 meters) every 15 days to lubricate working parts and prevent corrosion.

## Removing Vehicle From Storage

When your vehicle is ready to come out of storage, do the following:

- Wash your vehicle to remove any dirt or grease film build-up on window surfaces.
- Check windshield wipers for any deterioration.

## Vehicle Care

---

- Check under the hood for any foreign material that may have collected during storage (mice/squirrel nests).
- Check the exhaust for any foreign material that may have collected during storage.
- Check tire pressures and set tire inflation per the Tire Label.
- Check brake pedal operation. Drive your vehicle 15 feet (4,5 meters) back and forth to remove rust build-up.
- Check fluid levels (including coolant, oil and gas) to make sure there are no leaks, and fluids are at recommended levels.
- If the battery was removed, clean the battery cable ends and inspect.

Contact your authorized dealer if you have any concerns or issues.

# Wheels and Tires

## GENERAL INFORMATION

A decal with tire pressure data is located in the driver's door opening.

Check and set the tire pressure at the ambient temperature in which you are intending to drive your vehicle and when the tires are cold.

**Note:** Check your tire pressures regularly to optimize fuel economy.

**Note:** Use only approved wheel and tire sizes. Using other sizes could damage your vehicle and will make the National Type Approval invalid.

**Note:** If you change the diameter of the tires from that fitted at the factory, the speedometer may not display the correct speed. Take your vehicle to an authorized dealer to have the engine management system reprogrammed.

**Note:** If you intend to change the size of the wheels from that fitted at the factory, check the suitability with an authorized dealer.

## TIRE CARE

**Important information for 205/40R17 low-profile tires and wheels** If your vehicle is equipped with 205/40R17 tires, they are low-profile tires. These tires and wheels are designed to give your vehicle a sport appearance. With low-profile tires, you may notice an increase in road noise and faster tire wear, depending on road conditions and

driving styles. Due to their design, low-profile tires and wheels are more prone to road damage from potholes, rough or unpaved roads, car wash rails and curb contact than standard tires and wheels.

**Note:** Your vehicle's warranty does not cover these types of damage. Tires should always be kept at the correct inflation pressures and extra caution should be taken when operating on rough roads to avoid impacts that could cause wheel and tire damage.

## Information About Uniform Tire Quality Grading



E142542

Tire Quality Grades apply to new pneumatic passenger car tires. The Quality grades can be found where applicable on the tire sidewall between tread shoulder and maximum section width. For example: **Treadwear 200 Traction AA Temperature A.**

These Tire Quality Grades are determined by standards that the United States Department of Transportation has set.

# Wheels and Tires

---

Tire Quality Grades apply to new pneumatic passenger car tires. They do not apply to deep tread, winter-type snow tires, space-saver or temporary use spare tires, light truck or LT type tires, tires with nominal rim diameters of 10 to 12 inches or limited production tires as defined in Title 49 Code of Federal Regulations Part 575.104 ©)(2).

## U.S. Department of Transportation Tire quality

**grades:** The U.S. Department of Transportation requires Ford Motor Company to give you the following information about tire grades exactly as the government has written it.

### Treadwear

The treadwear grade is a comparative rating based on the wear rate of the tire when tested under controlled conditions on a specified government test course. For example, a tire graded 150 would wear one and one-half (1 ½) times as well on the government course as a tire graded 100. The relative performance of tires depends upon the actual conditions of their use, however, and may depart significantly from the norm due to variations in driving habits, service practices, and differences in road characteristics and climate.

### Traction AA A B C

#### WARNING

 The traction grade assigned to this tire is based on straight-ahead braking traction tests, and does not include acceleration, cornering, hydroplaning or peak traction characteristics.

The traction grades, from highest to lowest are AA, A, B, and C. The grades represent the tire's ability to stop on wet pavement as measured under controlled conditions on specified government test surfaces of asphalt and concrete. A tire marked C may have poor traction performance.

### Temperature A B C

#### WARNING

 The temperature grade for this tire is established for a tire that is properly inflated and not overloaded. Excessive speed, under-inflation, or excessive loading, either separately or in combination, can cause heat buildup and possible tire failure.

The temperature grades are A (the highest), B and C, representing the tire's resistance to the generation of heat and its ability to dissipate heat when tested under controlled conditions on a specified indoor laboratory

# Wheels and Tires

---

test wheel. Sustained high temperature can cause the material of the tire to degenerate and reduce tire life, and excessive temperature can lead to sudden tire failure. The grade C corresponds to a level of performance which all passenger car tires must meet under the Federal Motor Vehicle Safety Standard No. 139. Grades B and A represent higher levels of performance on the laboratory test wheel than the minimum required by law.

## Glossary of Tire Terminology

\* **Tire label:** A label showing the OE (Original Equipment) tire sizes, recommended inflation pressure and the maximum weight the vehicle can carry.

\* **Tire Identification Number (TIN):** A number on the sidewall of each tire providing information about the tire brand and manufacturing plant, tire size and date of manufacture. Also referred to as DOT code.

\* **Inflation pressure:** A measure of the amount of air in a tire.

\* **Standard load:** A class of P-metric or Metric tires designed to carry a maximum load at 35 psi [37 psi (2.5 bar) for Metric tires]. Increasing the inflation pressure beyond this pressure will not increase the tire's load carrying capability.

\* **Extra load:** A class of P-metric or Metric tires designed to carry a heavier maximum load at 41 psi [43 psi (2.9 bar) for Metric tires]. Increasing the inflation pressure beyond this pressure will not increase the tire's load carrying capability.

\* **kPa:** Kilopascal, a metric unit of air pressure.

\* **PSI:** Pounds per square inch, a standard unit of air pressure.

\* **Cold tire pressure:** The tire pressure when the vehicle has been stationary and out of direct sunlight for an hour or more and prior to the vehicle being driven for 1 mile (1.6 kilometers).

\* **Recommended inflation pressure:** The cold inflation pressure found on the Safety Compliance Certification Label (affixed to either the door hinge pillar, door-latch post, or the door edge that meets the door-latch post, next to the driver's seating position), or Tire Label located on the B-Pillar or the edge of the driver's door.

\* **B-pillar:** The structural member at the side of the vehicle behind the front door

\* **Bead area of the tire:** Area of the tire next to the rim.

\* **Sidewall of the tire:** Area between the bead area and the tread.



# Wheels and Tires

\* **Tread area of the tire:** Area of the perimeter of the tire that contacts the road when mounted on the vehicle.

\* **Rim:** The metal support (wheel) for a tire or a tire and tube assembly upon which the tire beads are seated.

## Information Contained on the Tire Sidewall

Both U.S. and Canada Federal regulations require tire manufacturers to place standardized information on the sidewall of all tires. This information identifies and describes the fundamental characteristics of the tire and also provides a U.S. DOT Tire Identification Number for safety standard certification and in case of a recall.

## Information on P Type Tires

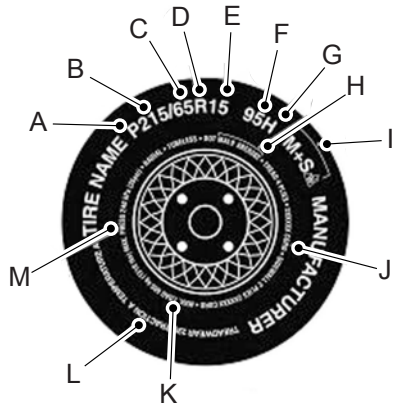

E142543

P215/65R15 95H is an example of a tire size, load index and speed rating. The definitions of these items are listed below. (Note that the tire size, load index and speed rating for your vehicle may be different from this example.)

**A. P:** Indicates a tire, designated by the Tire and Rim Association (T&RA), that may be used for service on cars, SUVs, minivans and light trucks. **Note:** If your tire size does not begin with a letter this may mean it is designated by either ETRTO (European Tire and Rim Technical Organization) or JATMA (Japan Tire Manufacturing Association).

# Wheels and Tires

**B. 215:** Indicates the nominal width of the tire in millimeters from sidewall edge to sidewall edge. In general, the larger the number, the wider the tire.

**C. 65:** Indicates the aspect ratio which gives the tire's ratio of height to width.

**D. R:** Indicates a radial type tire.

**E. 15:** Indicates the wheel or rim diameter in inches. If you change your wheel size, you will have to purchase new tires to match the new wheel diameter.

**F. 95:** Indicates the tire's load index. It is an index that relates to how much weight a tire can carry. You may find this information in your owner's manual. If not, contact a local tire dealer.

**Note:** *You may not find this information on all tires because it is not required by federal law.*

**G. H:** Indicates the tire's speed rating. The speed rating denotes the speed at which a tire is designed to be driven for extended periods of time under a standard condition of load and inflation pressure. The tires on your vehicle may operate at different conditions for load and inflation pressure. These speed ratings may need to be adjusted for the difference in conditions. The ratings range from 81 mph (130 km/h) to 186 mph (299 km/h). These ratings are listed in the following chart.

**Note:** *You may not find this information on all tires because it is not required by federal law.*

Letter rating	Speed rating - mph (km/h)
M	81 mph (130 km/h)
N	87 mph (140 km/h)
Q	99 mph (159 km/h)
R	106 mph (171 km/h)
S	112 mph (180 km/h)
T	118 mph (190 km/h)
U	124 mph (200 km/h)
H	130 mph (210 km/h)
V	149 mph (240 km/h)
W	168 mph (270 km/h)
Y	186 mph (299 km/h)

**Note:** *For tires with a maximum speed capability over 149 mph (240 km/h), tire manufacturers sometimes use the letters ZR. For those with a maximum speed capability over 186 mph (299 km/h), tire manufacturers always use the letters ZR.*

**H. U.S. DOT Tire Identification Number (TIN):** This begins with the letters DOT and indicates that the tire meets all federal standards. The next two numbers or letters are the plant code designating where it was manufactured, the next two are

# Wheels and Tires

---

the tire size code and the last four numbers represent the week and year the tire was built. For example, the numbers 317 mean the 31st week of 1997. After 2000 the numbers go to four digits. For example, 2501 means the 25th week of 2001. The numbers in between are identification codes used for traceability. This information is used to contact customers if a tire defect requires a recall.

**I. M+S or M/S:** Mud and Snow, or

**AT:** All Terrain, or

**AS:** All Season.

## **J. Tire Ply Composition and Material Used:**

Indicates the number of plies or the number of layers of rubber-coated fabric in the tire tread and sidewall. Tire manufacturers also must indicate the ply materials in the tire and the sidewall, which include steel, nylon, polyester, and others.

**K. Maximum Load:** Indicates the maximum load in kilograms and pounds that can be carried by the tire. Refer to the Safety Compliance Certification Label (affixed to either the door hinge pillar, door-latch post, or the door edge that meets the door-latch post, next to the driver's seating position), for the correct tire pressure for your vehicle.

## **L. Treadwear, Traction and Temperature Grades:**

**\*Treadwear** The treadwear grade is a comparative rating based on the wear rate of the tire when tested under controlled conditions on a specified government test course. For example, a tire graded 150 would wear one and one-half times as well on the government course as a tire graded 100.

**\*Traction:** The traction grades, from highest to lowest are AA, A, B, and C. The grades represent the tire's ability to stop on wet pavement as measured under controlled conditions on specified government test surfaces of asphalt and concrete. A tire marked C may have poor traction performance.

**\*Temperature:** The temperature grades are A (the highest), B and C, representing the tire's resistance to the generation of heat and its ability to dissipate heat when tested under controlled conditions on a specified indoor laboratory test wheel.

## **M. Maximum Inflation**

**Pressure:** Indicates the tire manufacturers' maximum permissible pressure or the pressure at which the maximum load can be carried by the tire. This pressure is normally higher than the vehicle manufacturer's recommended cold inflation pressure which can be found on the Safety Compliance Certification Label (affixed to either the door hinge pillar, door-latch post, or the door edge

# Wheels and Tires

that meets the door-latch post, next to the driver's seating position), or Tire Label which is located on the B-Pillar or the edge of the driver's door. The cold inflation pressure should never be set lower than the recommended pressure on the vehicle label.

The tire suppliers may have additional markings, notes or warnings such as standard load, radial tubeless, etc.

## Additional Information Contained on the Tire Sidewall for LT Type Tires

**Note:** *Tire Quality Grades do not apply to this type of tire.*

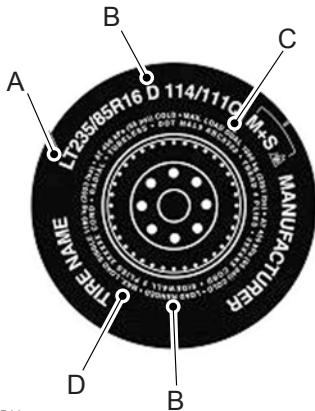

E142544

LT type tires have some additional information beyond those of P type tires; these differences are described below.

**A. LT:** Indicates a tire, designated by the Tire and Rim Association (T&RA), that is intended for service on light trucks.

**B. Load Range and Load Inflation Limits:** Indicates the tire's load-carrying capabilities and its inflation limits.

**C. Maximum Load Dual lb (kg) at psi (kPa) cold:** Indicates the maximum load and tire pressure when the tire is used as a dual; defined as four tires on the rear axle (a total of six or more tires on the vehicle).

**D. Maximum Load Single lb (kg) at psi (kPa) cold:** Indicates the maximum load and tire pressure when the tire is used as a single; defined as two tires (total) on the rear axle.

## Information on T Type Tires

T145/80D16 is an example of a tire size.

**Note:** *The temporary tire size for your vehicle may be different from this example. Tire Quality Grades do not apply to this type of tire.*

# Wheels and Tires

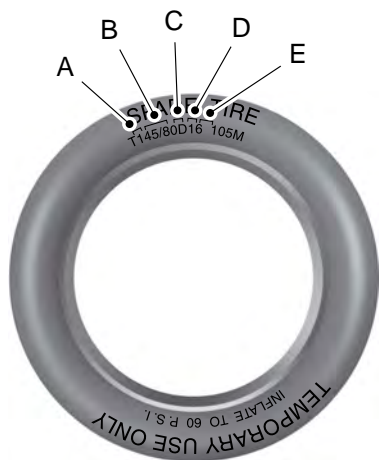

E142545

T type tires have some additional information beyond those of P type tires; these differences are described below:

**A. T:** Indicates a type of tire, designated by the Tire and Rim Association (T&RA), that is intended for temporary service on cars, SUVs, minivans and light trucks.

**B. 145:** Indicates the nominal width of the tire in millimeters from sidewall edge to sidewall edge. In general, the larger the number, the wider the tire.

**C. 80:** Indicates the aspect ratio which gives the tire's ratio of height to width. Numbers of 70 or lower indicate a short sidewall.

**D. D:** Indicates a diagonal type tire.

**R:** Indicates a radial type tire.

**E. 16:** Indicates the wheel or rim diameter in inches. If you change your wheel size, you will have to purchase new tires to match the new wheel diameter.

## Location of the Tire Label

You will find a Tire Label containing tire inflation pressure by tire size and other important information located on the B-Pillar or the edge of the driver's door.

## Inflating Your Tires

Safe operation of your vehicle requires that your tires are properly inflated. Remember that a tire can lose up to half of its air pressure without appearing flat.

Every day before you drive, check your tires. If one looks lower than the others, use a tire gauge to check pressure of all tires and adjust if required.

At least once a month and before long trips, inspect each tire and check the tire pressure with a tire gauge (including spare, if equipped). Inflate all tires to the inflation pressure recommended by Ford Motor Company.

## Wheels and Tires

---

You are strongly urged to buy a reliable tire pressure gauge, as automatic service station gauges may be inaccurate. Ford recommends the use of a digital or dial-type tire pressure gauge rather than a stick-type tire pressure gauge.

Use the recommended cold inflation pressure for optimum tire performance and wear. Under-inflation or over-inflation may cause uneven treadwear patterns

### WARNING



Under-inflation is the most common cause of tire failures and may result in severe tire cracking, tread separation or blowout, with unexpected loss of vehicle control and increased risk of injury. Under-inflation increases sidewall flexing and rolling resistance, resulting in heat buildup and internal damage to the tire. It also may result in unnecessary tire stress, irregular wear, loss of vehicle control and accidents. A tire can lose up to half of its air pressure and not appear to be flat!

Always inflate your tires to the Ford recommended inflation pressure even if it is less than the maximum inflation pressure information found on the tire. The Ford recommended tire inflation pressure is found on the Safety Compliance Certification Label

(affixed to either the door hinge pillar, door-latch post, or the door edge that meets the door-latch post, next to the driver's seating position), or Tire Label which is located on the B-Pillar or the edge of the driver's door. Failure to follow the tire pressure recommendations can cause uneven treadwear patterns and adversely affect the way your vehicle handles

**Maximum Inflation Pressure** is the tire manufacturer's maximum permissible pressure and the pressure at which the maximum load can be carried by the tire. This pressure is normally higher than the manufacturer's recommended cold inflation pressure which can be found on the Safety Compliance Certification Label (affixed to either the door hinge pillar, door-latch post, or the door edge that meets the door-latch post, next to the driver's seating position), or Tire Label which is located on the B-Pillar or the edge of the driver's door. The cold inflation pressure should never be set lower than the recommended pressure on the Safety Compliance Certification Label or Tire Label.

## Wheels and Tires

---

When weather temperature changes occur, tire inflation pressures also change. A 10°F (6°C) temperature drop can cause a corresponding drop of 1 psi (7 kPa) in inflation pressure. Check your tire pressures frequently and adjust them to the proper pressure which can be found on the Safety Compliance Certification Label or Tire Label.

To check the pressure in your tire(s):

1. Make sure the tires are cool, meaning they are not hot from driving even a mile.

**Note:** *If you are checking tire pressure when the tire is hot, (i.e. driven more than 1 mile [1.6 km]), never bleed or reduce air pressure. The tires are hot from driving and it is normal for pressures to increase above recommended cold pressures. A hot tire at or below recommended cold inflation pressure could be significantly under-inflated.*

**Note:** *If you have to drive a distance to get air for your tire(s), check and record the tire pressure first and add the appropriate air pressure when you get to the pump. It is normal for tires to heat up and the air pressure inside to go up as you drive.*

2. Remove the cap from the valve on one tire, then firmly press the tire gauge onto the valve and measure the pressure.

3. Add enough air to reach the recommended air pressure.

**Note:** *If you overfill the tire, release air by pressing on the metal stem in the center of the valve. Then recheck the pressure with your tire gauge.*

4. Replace the valve cap.

5. Repeat this procedure for each tire, including the spare.

**Note:** *Some spare tires operate at a higher inflation pressure than the other tires. For T type mini-spare tires (refer to the Dissimilar spare wheel and tire assembly information for a description): Store and maintain at 60 psi (4.15 bar). For full-size and dissimilar spare tires (refer to the Dissimilar spare wheel and tire assembly information for a description): Store and maintain at the higher of the front and rear inflation pressure as shown on the Tire Label.*

6. Visually inspect the tires to make sure there are no nails or other objects embedded that could poke a hole in the tire and cause an air leak.

7. Check the sidewalls to make sure there are no gouges, cuts or bulges.

# Wheels and Tires

## Inspecting Your Tires and Wheel Valve Stems

Periodically inspect the tire treads for uneven or excessive wear and remove objects such as stones, nails or glass that may be wedged in the tread grooves. Check the tire and valve stems for holes, cracks, or cuts that may permit air leakage and repair or replace the tire and replace the valve stem. Inspect the tire sidewalls for cracking, cuts, bruises and other signs of damage or excessive wear. If internal damage to the tire is suspected, have the tire demounted and inspected in case it needs to be repaired or replaced. For your safety, tires that are damaged or show signs of excessive wear should not be used because they are more likely to blow out or fail.

Improper or inadequate vehicle maintenance can cause tires to wear abnormally. Inspect all your tires, including the spare, frequently, and replace them if one or more of the following conditions exist:

## Tire Wear

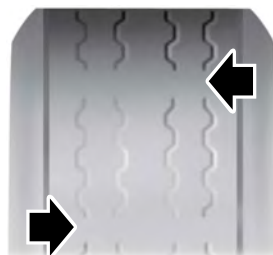

E142546

When the tread is worn down to one sixteenth of an inch (2 mm), tires must be replaced to help prevent your vehicle from skidding and hydroplaning. Built-in treadwear indicators, or wear bars, which look like narrow strips of smooth rubber across the tread will appear on the tire when the tread is worn down to one sixteenth of an inch (2 mm)

When the tire tread wears down to the same height as these wear bars, the tire is worn out and must be replaced.

## Damage

Periodically inspect the tire treads and sidewalls for damage (such as bulges in the tread or sidewalls, cracks in the tread groove and separation in the tread or sidewall). If damage is observed



# Wheels and Tires

---

or suspected have the tire inspected by a tire professional. Tires can be damaged during off-road use, so inspection after off-road use is also recommended.

## Age

### WARNING



Tires degrade over time depending on many factors such as weather, storage conditions, and conditions of use (load, speed, inflation pressure, etc.) the tires experience throughout their lives.

In general, tires should be replaced after six years regardless of tread wear. However, heat caused by hot climates or frequent high loading conditions can accelerate the aging process and may require tires to be replaced more frequently.

You should replace your spare tire when you replace the road tires or after six years due to aging even if it has not been used.

## U.S. DOT Tire Identification Number (TIN)

Both U.S. and Canada Federal regulations require tire manufacturers to place standardized information on the sidewall of all tires. This information identifies and

describes the fundamental characteristics of the tire and also provides a U.S. DOT Tire Identification Number for safety standard certification and in case of a recall.

This begins with the letters DOT and indicates that the tire meets all federal standards. The next two numbers or letters are the plant code designating where it was manufactured, the next two are the tire size code and the last four numbers represent the week and year the tire was built. For example, the numbers 317 mean the 31st week of 1997. After 2000 the numbers go to four digits. For example, 2501 means the 25th week of 2001. The numbers in between are identification codes used for traceability. This information is used to contact customers if a tire defect requires a recall.

## Tire Replacement Requirements

Your vehicle is equipped with tires designed to provide a safe ride and handling capability.

### WARNINGS



Only use replacement tires and wheels that are the same size, load index, speed rating and type (such as P-metric versus LT-metric or all-season versus all-terrain) as those originally provided by Ford. The recommended tire and wheel size

# Wheels and Tires

---

## WARNINGS

may be found on either the Safety Compliance Certification Label (affixed to either the door hinge pillar, door-latch post, or the door edge that meets the door-latch post, next to the driver's seating position), or the Tire Label which is located on the B-Pillar or edge of the driver's door. If this information is not found on these labels then you should contact your authorized dealer as soon as possible. Use of any tire or wheel not recommended by Ford can affect the safety and performance of your vehicle, which could result in an increased risk of loss of vehicle control, vehicle rollover, personal injury and death. Additionally the use of non-recommended tires and wheels could cause steering, suspension, axle, transfer case or power transfer unit failure. If you have questions regarding tire replacement, contact your authorized dealer as soon as possible.



When mounting replacement tires and wheels, you should not exceed the maximum pressure indicated on the sidewall of the tire to set the beads without additional precautions listed below. If the beads do not seat at the maximum pressure indicated, re-lubricate and try again

## WARNINGS

When inflating the tire for mounting pressures up to 20 psi (1.38 bar) greater than the maximum pressure on the tire sidewall, the following precautions must be taken to protect the person mounting the tire:

1. Make sure that you have the correct tire and wheel size.
2. Lubricate the tire bead and wheel bead seat area again.
3. Stand at a minimum of 12 ft (3.66 m) away from the wheel and tire assembly.
4. Use both eye and ear protection.

For a mounting pressure more than 20 psi (1.38 bar) greater than the maximum pressure, a Ford dealer or other tire service professional should do the mounting.

Always inflate steel carcass tires with a remote air fill with the person inflating standing at a minimum of 12 ft (3.66 m) away from the wheel and tire assembly

---

**Important:** Remember to replace the wheel valve stems when the road tires are replaced on your vehicle

# Wheels and Tires

---

It is recommended that the two front tires or two rear tires generally be replaced as a pair.

The tire pressure sensors mounted in the wheels (originally installed on your vehicle) are not designed to be used in aftermarket wheels.

The use of wheels or tires not recommended by Ford Motor Company may affect the operation of your tire pressure monitoring system.

If the TPMS indicator is flashing, your TPMS is malfunctioning. Your replacement tire might be incompatible with your TPMS, or some component of the TPMS may be damaged.

## Safety Practices

### WARNINGS



If your vehicle is stuck in snow, mud, sand, etc., do not rapidly spin the tires; spinning the tires can tear the tire and cause an explosion. A tire can explode in as little as three to five seconds.



Do not spin the wheels at over 35 mph (56 km/h). The tires may fail and injure a passenger or bystander.

---

## Driving habits have a great deal to do with your tire mileage and safety.

\*Observe posted speed limits

\*Avoid fast starts, stops and turns

\*Avoid potholes and objects on the road

\*Do not run over curbs or hit the tire against a curb when parking

## Highway Hazards

No matter how carefully you drive there's always the possibility that you may eventually have a flat tire on the highway. Drive slowly to the closest safe area out of traffic. This may further damage the flat tire, but your safety is more important.

If you feel a sudden vibration or ride disturbance while driving, or you suspect your tire or vehicle has been damaged, immediately reduce your speed. Drive with caution until you can safely pull off the road. Stop and inspect the tires for damage. If a tire is under-inflated or damaged, deflate it, remove wheel and replace it with your spare tire and wheel. If you cannot detect a cause, have the vehicle towed to the nearest repair facility or tire dealer to have the vehicle inspected.

# Wheels and Tires

## Tire and Wheel Alignment

A bad jolt from hitting a curb or pothole can cause the front end of your vehicle to become misaligned or cause damage to your tires. If your vehicle seems to pull to one side when you're driving, the wheels may be out of alignment. Have an authorized dealer check the wheel alignment periodically.

Wheel misalignment in the front or the rear can cause uneven and rapid treadwear of your tires and should be corrected by an authorized dealer. Front-wheel drive vehicles and those with an independent rear suspension (if equipped) may require alignment of all four wheels.

The tires should also be balanced periodically. An unbalanced tire and wheel assembly may result in irregular tire wear.

## Tire Rotation

**Note:** *If your tires show uneven wear ask an authorized dealer to check for and correct any wheel misalignment, tire imbalance or mechanical problem involved before tire rotation.*

**Note:** *Your vehicle may be equipped with a dissimilar spare wheel and tire assembly. A dissimilar spare wheel and tire assembly is defined as a spare wheel and tire assembly that is different in brand, size or appearance from the road tires and wheels. If you have a dissimilar spare wheel and tire assembly it is intended for temporary use only and should not be used in a tire rotation.*

**Note:** *After having your tires rotated, inflation pressure must be checked and adjusted to the vehicle requirements.*

Rotating your tires at the recommended interval (as indicated in the Scheduled Maintenance chapter) will help your tires wear more evenly, providing better tire performance and longer tire life.

Front-wheel drive vehicles (front tires on the left side of the diagram)

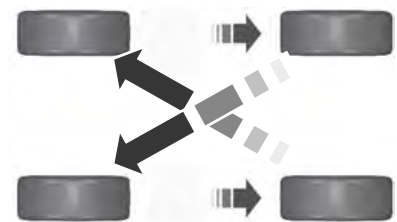

E142547

Sometimes irregular tire wear can be corrected by rotating the tires.

# Wheels and Tires

## Summer Tires

Your Ford vehicle may be equipped with summer tires to provide superior performance on wet and dry roads. Summer tires do not have the Mud and Snow (M+S or M/S) tire traction rating on the tire side wall. Since summer tires do not have the same traction performance as All-season or Snow tires, Ford does not recommend using summer tires when temperatures drop to approximately 40°F (5°C) or below (depending on tire wear and environmental conditions) or in snow and ice conditions. Like any tire, summer tire performance is affected by tire wear and environmental conditions. If you must drive in those conditions, Ford recommends using Mud and Snow (M+S, M/S), All-season or Snow tires.

## USING WINTER TIRES

### WARNING



When you use winter tires on your vehicle, you must make sure that you use the correct lug nuts.

If winter tires are used, you must make sure that you use the correct tire pressures.

## USING SNOW CHAINS

### WARNING



Your vehicle is not approved for use with snow chains.

## TIRE PRESSURE MONITORING SYSTEM

### WARNING



The tire pressure monitoring system is not a substitute for manually checking tire pressure. The tire pressure should be checked periodically (at least monthly) using a tire gauge, see Inflating your tires in this chapter. Failure to properly maintain your tire pressure could increase the risk of tire failure, loss of control, vehicle rollover and personal injury.



Each tire, including the spare (if provided), should be checked monthly when cold and inflated to the inflation pressure recommended by the vehicle manufacturer on the vehicle placard or tire inflation pressure label. (If your vehicle has tires of a different size than the size indicated on the vehicle placard or tire inflation pressure label, you should determine the proper tire inflation pressure for those tires.)

As an added safety feature, your vehicle has been equipped with a Tire Pressure Monitoring System (TPMS) that illuminates a low tire pressure telltale when one or more of your tires is significantly under-inflated. Accordingly, when the low tire pressure telltale illuminates, you should stop and check your tires as soon as possible, and inflate them to the proper pressure. Driving on a significantly under-inflated tire causes the tire to overheat and can lead to tire failure. Under-inflation also reduces fuel efficiency and tire tread life, and may affect the vehicle's handling and stopping ability.

# Wheels and Tires

Please note that the TPMS is not a substitute for proper tire maintenance, and it is the driver's responsibility to maintain correct tire pressure, even if under-inflation has not reached the level to trigger illumination of the TPMS low tire pressure telltale.

Your vehicle has also been equipped with a TPMS malfunction indicator to indicate when the system is not operating properly. The TPMS malfunction indicator is combined with the low tire pressure telltale. When the system detects a malfunction, the telltale will flash for approximately one minute and then remain continuously illuminated. This sequence will continue upon subsequent vehicle start-ups as long as the malfunction exists.

When the malfunction indicator is illuminated, the system may not be able to detect or signal low tire pressure as intended. TPMS malfunctions may occur for a variety of reasons, including the installation of replacement or alternate tires or wheels on the vehicle that prevent the TPMS from functioning properly. Always check the TPMS malfunction telltale after replacing one or more tires or wheels on your vehicle to ensure that the replacement or alternate tires and wheels allow the TPMS to continue to function properly.

The tire pressure monitoring system complies with part 15 of the FCC rules and with RSS-210 of Industry Canada. Operation is subject to the following two conditions: (1) This device may not cause harmful interference, and (2) This device must accept any interference received, including interference that may cause undesired operation.

## Changing Tires With a Tire Pressure Monitoring System



E142549

**Note:** Each road tire is equipped with a tire pressure sensor located inside the wheel and tire assembly cavity. The pressure sensor is attached to the valve stem. The pressure sensor is covered by the tire and is not visible unless the tire is removed. Take care when changing the tire to avoid damaging the sensor

You should always have your tires serviced by an authorized dealer.

Check the tire pressure periodically (at least monthly) using an accurate tire gauge. See *Inflating Your Tires* in this chapter.

## Understanding Your Tire Pressure Monitoring System

The tire pressure monitoring system measures pressure in your four road tires and sends the tire pressure readings to your vehicle. The low tire pressure warning light will turn on if the tire pressure is significantly low. Once the light is illuminated, your tires are under-inflated and need to be inflated to the manufacturer's recommended tire pressure. Even if the light turns on and a short time later turns off, your tire pressure still needs to be checked.

# Wheels and Tires

---

## **When Your Temporary Spare Tire is Installed**

When one of your road tires needs to be replaced with the temporary spare, the system will continue to identify an issue to remind you that the damaged road wheel and tire assembly needs to be repaired and put back on your vehicle.

To restore the full function of the tire pressure monitoring system, have the damaged road wheel and tire assembly repaired and remounted on your vehicle.

## **When You Believe Your System is Not Operating Properly**

The main function of the tire pressure monitoring system is to warn you when your tires need air. It can also warn you in the event the system is no longer capable of functioning as intended. See the following chart for information concerning your tire pressure monitoring system:

# Wheels and Tires

Low tire pressure warning light	Possible cause	Customer action required
Solid warning light	Tire(s) under-inflated	Make sure tires are at the proper pressure. See <a href="#">Inflating your tires</a> in this chapter. After inflating your tires to the manufacturer's recommended pressure as shown on the Tire Label (located on the edge of driver's door or the B-Pillar), the vehicle must be driven for at least two minutes over 20 mph (32 km/h) before the light turns off.
	Spare tire in use	Repair the damaged road wheel and tire assembly and reinstall it on the vehicle to restore system function. For a description on how the system functions, see <b>When your temporary spare tire is installed</b> in this section.
	TPMS malfunction	If the tires are properly inflated and the spare tire is not in use but the light remains on, contact your authorized dealer as soon as possible.
Flashing warning light	Spare tire in use	Repair the damaged road wheel and tire assembly and reinstall it on the vehicle to restore system function. For a description on how the system functions, see <b>When your temporary spare tire is installed</b> in this section.
	TPMS malfunction	If the tires are properly inflated and the spare tire is not in use but the light remains on, contact your authorized dealer as soon as possible.

## When Inflating Your Tires

When putting air into your tires (such as at a gas station or in your garage), the tire pressure monitoring system may not respond immediately to the air added to your tires.

It may take up to two minutes of driving over 20 mph (32 km/h) for the light to turn off after you have filled your tires to the recommended inflation pressure



# Wheels and Tires

## How Temperature Affects Your Tire Pressure

The tire pressure monitoring system monitors tire pressure in each pneumatic tire. While driving in a normal manner, a typical passenger tire inflation pressure may increase about 2 to 4 psi (14 to 28 kPa) from a cold start situation. If the vehicle is stationary overnight with the outside temperature significantly lower than the daytime temperature, the tire pressure may decrease about 3 psi (21 kPa) for a drop of 30°F (17°C) in ambient temperature. This lower pressure value may be detected by the tire pressure monitoring system as being significantly lower than the recommended inflation pressure and activate the system warning light for low tire pressure. If the low tire pressure warning light is on, visually check each tire to verify that no tire is flat. If one or more tires are flat, repair as necessary. Check the air pressure in the road tires. If any tire is under-inflated, carefully drive the vehicle to the nearest location where air can be added to the tires. Inflate all the tires to the recommended inflation pressure.

## CHANGING A ROAD WHEEL

### WARNINGS



The use of tire sealants may damage your tire pressure monitoring system and should not be used. However, if you must use a sealant, the tire pressure monitoring system sensor and valve stem on the wheel must be replaced by an authorized Ford dealer.



See **Tire Pressure Monitoring System** (page 226). If the tire pressure monitor sensor becomes damaged, it will no longer function.

**Note:** *The tire pressure monitoring system indicator light will illuminate when the spare tire is in use. To restore the full functionality of the monitoring system, all road wheels equipped with tire pressure monitoring sensors must be mounted on the vehicle.*

If you get a flat tire while driving, do not apply the brake heavily. Instead, gradually decrease your speed. Hold the steering wheel firmly and slowly move to a safe place on the side of the road.

Have a flat serviced by an authorized dealer in order to prevent damage to the tire pressure monitoring system sensors. See **Tire Pressure Monitoring System** (page 226). Replace the spare tire with a road tire as soon as possible. During repairing or replacing of the flat tire, have an authorized dealer inspect the tire pressure monitoring system sensor for damage.

## Dissimilar Spare Wheel and Tire Assembly Information

### WARNING



Failure to follow these guidelines could result in an increased risk of loss of vehicle control, injury or death.

If you have a dissimilar spare wheel and tire, then it is intended for temporary use only. This means that if you need to use it, you should replace it as soon as possible with a road wheel and tire assembly that is the same size and type as the road tires and wheels that were originally provided by Ford. If the dissimilar spare tire or wheel is damaged, it should be replaced rather than repaired.

A dissimilar spare wheel and tire assembly is defined as a spare wheel and tire assembly that is different in brand, size or appearance from the road tires and wheels and can be one of three types:

# Wheels and Tires

**1. T-type mini-spare:** This spare tire begins with the letter T for tire size and may have Temporary Use Only molded in the sidewall.

**2. Full-size dissimilar spare with label on wheel:** This spare tire has a label on the wheel that states: THIS WHEEL AND TIRE ASSEMBLY FOR TEMPORARY USE ONLY.

When driving with one of the dissimilar spare tires listed above, do not:

- Exceed 50 mph (80 km/h)
- Load the vehicle beyond maximum vehicle load rating listed on the Safety Compliance Label.
- Tow a trailer.
- Use more than one dissimilar spare tire at a time.
- Use commercial car washing equipment.
- Try to repair the dissimilar spare tire.

Use of one of the dissimilar spare tires listed above at any one wheel location can lead to impairment of the following:

- Handling, stability and braking performance.
- Comfort and noise.
- Ground clearance and parking at curbs.
- Winter weather driving capability.
- Wet weather driving capability.
- All-wheel driving capability (if applicable).

**3. Full-size dissimilar spare without label on wheel**

When driving with the full-size dissimilar spare wheel and tire assembly, do not:

- Exceed 70 mph (113 km/h).
- Use more than one dissimilar spare wheel and tire assembly at a time.
- Use commercial car washing equipment.

The usage of a full-size dissimilar spare wheel and tire assembly can lead to impairment of the following:

- Handling, stability and braking performance.
- Comfort and noise.
- Ground clearance and parking at curbs.
- Winter weather driving capability.
- Wet weather driving capability.
- All-wheel driving capability

When driving with the full-size dissimilar spare wheel and tire assembly additional caution should be given to:

- Towing a trailer.
- Driving vehicles equipped with a camper body.
- Driving vehicles with a load on the cargo rack.

Drive cautiously when using a full-size dissimilar spare wheel and tire assembly and seek service as soon as possible.

## Tire Change Procedure

### WARNINGS



When one of the front wheels is off the ground, the transmission alone will not prevent the vehicle from moving or slipping off the jack, even if the transmission selector lever is in position **P**.



To help prevent your vehicle from moving when you change a tire, be sure to place the transmission selector lever in position **P**, set the parking brake and block (in both directions) the wheel that is diagonally opposite (other side and end of the vehicle) to the tire being changed.



Never get underneath a vehicle that is supported only by a jack. If your vehicle slips off the jack, you or someone else could be seriously injured.

# Wheels and Tires

## WARNINGS



Do not attempt to change a tire on the side of the vehicle close to moving traffic. Pull far enough off the road to avoid the danger of being hit when operating the jack or changing the wheel.



Always use the jack provided as original equipment with your vehicle. If using a jack other than the one provided as original equipment with your vehicle, make sure the jack capacity is adequate for the vehicle weight, including any vehicle cargo or modifications.



Make sure there is no lubrication (grease or oil) on the threads or the surface between the wheel lugs and nuts. This can cause the lug nuts to loosen while driving.

**Note:** *Passengers should not remain in the vehicle when the vehicle is being jacked.*

1. Park on a level surface, set the parking brake and activate the hazard flashers.
2. Place the transmission selector lever in position **P** (automatic transmission) or position **R** (manual transmission) and turn the engine off.
3. Remove the carpeted wheel cover.
4. Remove the spare tire bolt securing the spare tire by turning it counterclockwise.
5. Remove the spare tire from the spare tire compartment.



E142550

6. Remove the lug wrench and jack from the foam holder.

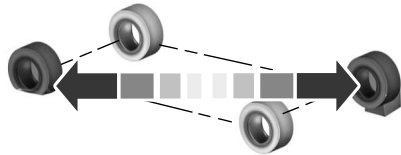

E142551

7. Block the diagonally opposite wheel.
8. Loosen each wheel lug nut one-half turn counterclockwise but do not remove them until the wheel is raised off the ground.

**Note:** *Jack at the specified locations to avoid damage to the vehicle.*

9. The vehicle jacking points are shown here, and are depicted on the yellow warning label on the jack.



E145908

# Wheels and Tires

10. Indentations in the sills show the location of the jacking points.



E142553

11. Remove the lug nuts with the lug wrench.
12. Replace the flat tire with the spare tire, making sure the valve stem is facing outward. Reinstall the lug nuts until the wheel is snug against the hub. Do not fully tighten the lug nuts until the wheel has been lowered.
13. Lower the wheel by turning the jack handle counterclockwise.

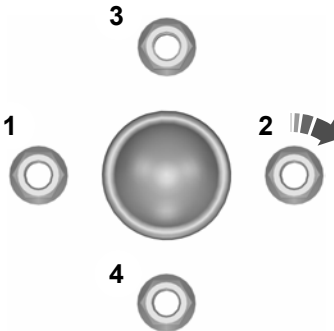

E90589

14. Remove the jack and fully tighten the lug nuts in the order shown. See **Technical Specifications** (page 234).

## Stowing the flat tire

The full-size road wheel can be stowed in the spare tire compartment.

1. Lift the carpeted wheel cover at an angle to access the spare tire compartment.
2. Place the wheel in the spare tire well with the valve stem facing down. Use the mini-spare bolt to secure the wheel through one of the lug holes.
3. Place the jack, tools and foam block back into the spare tire compartment.
4. Replace the carpeted wheel cover.



E146026

# Wheels and Tires

## TECHNICAL SPECIFICATIONS

### Wheel Lug Nut Torque Specifications

#### WARNING



When a wheel is installed, always remove any corrosion, dirt or foreign materials present on the mounting surfaces of the wheel or the surface of the wheel hub, brake drum or brake disc that contacts the wheel. Make sure that any fasteners that attach the rotor to the hub are secured so they do not interfere with the mounting surfaces of the wheel. Installing wheels without correct metal-to-metal contact at the wheel mounting surfaces can cause the wheel nuts to loosen and the wheel to come off while your vehicle is in motion, resulting in loss of control.

Bolt size	lb-ft (Nm)*
M12 x 1.5	100 (135)

\*Torque specifications are for nut and bolt threads free of dirt and rust. Use only Ford recommended replacement fasteners.

Retighten the lug nuts to the specified torque within 100 miles (160 kilometers) after any wheel disturbance (such as tire rotation, changing a flat tire, wheel removal).



E145950

A Wheel pilot bore

Inspect the wheel pilot bore and mounting surface prior to installation. Remove any visible corrosion or loose particles.

# Capacities and Specifications

## ENGINE SPECIFICATIONS

Engine	1.0L EcoBoost	1.6L Duratec-16V Ti-VCT	1.6L EcoBoost
Cubic inches	61	98	98
Required fuel	Minimum 87 octane	Minimum 87 octane	Minimum 87 octane
Compression ratio	10:1	11:1	10:1

### Drivebelt Routing

#### 1.0L EcoBoost

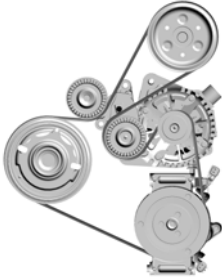

E163197

#### 1.6L Duratec-16V Ti-VCT

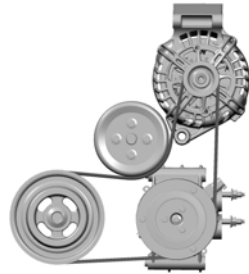

E163198

#### 1.6L EcoBoost



E161372

# Capacities and Specifications

## MOTORCRAFT PARTS

Component	1.0L EcoBoost	1.6L Duratec-16V Ti-VCT	1.6L EcoBoost
Air filter element <sup>1</sup>	FA-1914		
Oil filter <sup>2</sup>	FL-910S		
Battery	BXT-96R-500 BXT-96R-590		
Spark plugs <sup>3</sup>	SP-532	SP-525	SP-532
Cabin air filter	FP-69		
Windshield wiper blade	WW-1613 (driver side) WW-2430 (passenger side)		

<sup>1</sup> Failure to use the correct air filter element may result in severe engine damage. Your warranty may be void for any damage to the engine if the correct air filter element is not used.

<sup>2</sup> Only use the specified replacement oil filter. The use of a non-specified oil filter can result in engine damage. See **Scheduled Maintenance** (page 371).

<sup>3</sup> For spark plug replacement, see an authorized dealer. Replace the spark plugs at the appropriate intervals.

**Note:** *Replace the spark plugs with ones that meet Ford material and design specifications for your vehicle, such as Motorcraft or equivalent replacement parts. Your warranty may be void for any damage to the engine if the correct spark plugs are not used.*

Do not use American Petroleum Institute S category oils labeled as SN, SM, SL or a lower category unless the label also displays the American Petroleum Institute certification mark. These oils do not meet all of the requirements of your vehicle's engine and emissions system.

# Capacities and Specifications

## VEHICLE IDENTIFICATION NUMBER

The vehicle identification number is located on the left-hand side of the instrument panel.

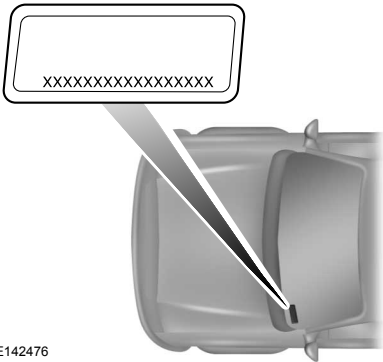

E142476

Please note that in the graphic, XXXX is representative of your vehicle identification number.

The Vehicle Identification Number contains the following information:

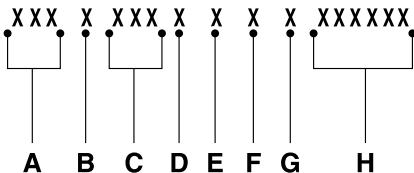

E142477

- A World manufacturer identifier
- B Brake system, Gross Vehicle Weight Rating, Restraint Devices and their locations

- C Make, vehicle line, series, body type
- D Engine type
- E Check digit
- F Model year
- G Assembly plant
- H Production sequence number

## VEHICLE CERTIFICATION LABEL

**MFD. BY FORD MOTOR CO.**

DATE: XX/XX	GVWR: XXXX KG ( XXXX LB)	
FRONT GAWR:	REAR GAWR:	
XXXX KG ( XXXX LB)	WITH XXXX KG ( XXXX LB)	WITH
XXXXXXXXXXXXXXXXXX	TIRES XXXXXXXXXXXXXXXXXXXX	TIRES
XXXXXXX	RIMS XXXXXX	RIMS
AT XXXX kPa/ XXX PSI COLD	AT XXXX kPa/ XXX PSI COLD	RIMS

THIS VEHICLE CONFORMS TO ALL APPLICABLE FEDERAL MOTOR VEHICLE SAFETY AND THEFT PREVENTION STANDARDS IN EFFECT ON THE DATE OF MANUFACTURE SHOWN ABOVE.

VIN: XXXXXXXXXXXXXXXXXXXX XXXXX  
XXXXX

TYPE: XXXX

EXT PNT: XX	XXXXXX	RC: XX	DSO: XXXX
WB	INT TR	TP/PS	R AXLE
XXX	XX	XX	X
		XXX	XXXX XXXX
		XXXXXXXXXXXXXX	XXX XXXX-XXXXXX-XX

E167469



# Capacities and Specifications

The National Highway Traffic Safety Administration Regulations require that a Safety Compliance Certification Label be affixed to a vehicle and prescribe where the Safety Compliance Certification Label may be located. The Safety Compliance Certification Label shall be affixed to either the door hinge pillar, the door latch post, or the edge of the door near the door latch, next to the driver's seating position.

## TRANSMISSION CODE DESIGNATION

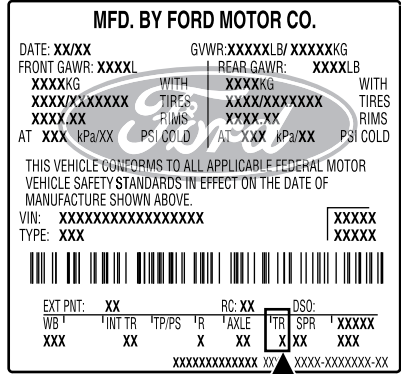

E142806

The transmission code is on the Safety Compliance Certification Label. The following table shows the transmission code along with the transmission description.

Description	Code
Six-speed automatic transmission	A
Six-speed manual transmission	M
Five-speed manual transmission	C

# Accessories

---

For a complete listing of the accessories that are available for your vehicle, please contact your dealer or visit our online store at: **Accessories.Ford.com** (U.S. only).

Ford Custom Accessories are available for your vehicle through your local Ford or Ford of Canada dealer. Ford Motor Company will repair or replace any properly dealer-installed Ford Custom Accessories found to be defective in factory-supplied materials or workmanship during the warranty period, as well as any component damaged by the defective accessories. The accessories will be warranted for whichever provides you the greatest benefit:

- 12 months or 12,000 miles (20,000 km) (whichever occurs first), or
- the remainder of your new vehicle limited warranty.

Contact your dealer for details and a copy of the warranty.

## Exterior style

- Graphics kit
- Hood deflectors
- Side window deflectors
- Splash guards
- Rear spoiler
- Wheels
- Bumper protectors

## Interior style

- All-weather floor mats
- Rear seat entertainment\*
- Premium carpeted floor mats
- Lighted door sill plates

## Lifestyle

- Ash cup / smoker's packages
- Roof racks and carriers\*

## Peace of mind

- Remote start
- Vehicle security systems
- Wheel locks
- Bumper-mounted parking sensor\*
- Locking fuel plug for capless fuel system

\*Ford Licensed Accessories (FLA) are warranted by the accessory manufacturer's warranty. Ford Licensed Accessories are fully designed and developed by the accessory manufacturer and have not been designed or tested to Ford Motor Company engineering requirements. Contact your Ford dealer for details regarding the manufacturer's limited warranty and a copy of the FLA product limited warranty offered by the accessory manufacturer.

For maximum vehicle performance, keep the following information in mind when adding accessories or equipment to your vehicle:

- When adding accessories, equipment, passengers and luggage to your vehicle, do not exceed the total weight capacity of the vehicle or of the front or rear axle (GVWR or GAWR as indicated on the Safety Compliance Certification label). Consult your authorized dealer for specific weight information.
- The Federal Communications Commission (FCC) and Canadian Radio Telecommunications Commission (CRTC) regulate the use of mobile communications systems — such as two-way radios, telephones and theft alarms — that are equipped with radio transmitters. Any such equipment installed in your vehicle should comply with FCC or CRTC regulations and should be installed only by a qualified service technician.

# Accessories

---

- Mobile communications systems may harm the operation of your vehicle, particularly if they are not properly designed for automotive use.
- To avoid interference with other vehicle functions, such as anti-lock braking systems, amateur radio users who install radios and antennas onto their vehicle should not locate the amateur radio antennas in the area of the driver's side hood.
- Any non-Ford custom electrical or electronic accessories or components that are added to the vehicle by the authorized dealer or the owner, may adversely affect battery performance and durability, and may also adversely affect the performance of other electrical systems in the vehicle.

# Ford Extended Service Plan (ESP)

---

PROTECT YOURSELF FROM THE RISING COST OF VEHICLE REPAIRS WITH A FORD EXTENDED SERVICE PLAN.

## **SERVICE PLANS (U.S. Only)**

More than 32 million Ford and Lincoln owners have discovered the powerful protection of Ford Extended Service Plan. It is the only extended service plan backed by Ford Motor Company, and provides peace of mind protection beyond the New Vehicle Limited Warranty coverage.

### **Ford ESP Can Quickly Pay for Itself**

One service bill – the cost of parts and labor – can easily exceed the price of your Ford Extended Service Plan. With Ford ESP, you minimize your risk for unexpected repair bills and rising repair costs.

### **Up to 500+ Covered Vehicle Components**

There are four Extended Service Plans with different levels of coverage. Ask your authorized dealer for details.

1. PremiumCARE - Our most comprehensive coverage. With over 500 covered components, this plan is so complete that we generally only discuss what's not covered.
2. ExtraCARE - Covers 113 components, and includes many high-tech items.
3. BaseCARE - Covers 84 components.
4. PowertrainCARE - Covers 29 critical components.

Ford Extended Service Plan is honored by all authorized Ford and Lincoln dealers in the U.S. and Canada. It is the only extended service plan authorized and backed by Ford Motor Company.

That means you get:

- Reliable, quality service anywhere you go
- Repairs performed by factory trained technicians, using Genuine Ford and Lincoln parts

### **Rental Car Reimbursement**

#### ***1st day Rental Benefit***

You take advantage of replacement transportation if your vehicle is at your authorized dealer for same day covered repairs.

#### ***Extended Rental Benefits***

If your vehicle is kept overnight for covered repairs, you are eligible for rental car coverage, including Bumper to Bumper warranty repairs, or Field Service Actions.

### **Roadside Assistance**

Exclusive 24/7 roadside assistance, including:

- Towing, flat-tire change and battery jump starts
- Out of fuel and lock-out assistance
- Travel expense reimbursement for lodging, meals and rental car
- Destination assistance for taxi, shuttle, rental car coverage and emergency transportation

### **Transferable Coverage**

If you sell your vehicle before your Ford Extended Service Plan coverage expires, you can transfer any remaining coverage to the new owner. Whenever you sell your vehicle, prospective buyers may have a higher degree of confidence that vehicle was properly maintained with Ford ESP, thereby improving resale value.

# Ford Extended Service Plan (ESP)

## Avoid the Rising Cost of Properly Maintaining Your Vehicle!

Ford Extended Service Plan also offers a Premium Maintenance Plan that covers all scheduled maintenance, and select items that routinely wear out.

The coverage is prepaid, so you never have to worry about affording your vehicle maintenance. It covers regular checkups, routine inspections, preventive care and replacement of select items that require periodic attention for normal wear:

- Windshield Wiper Blades
- Spark Plugs (except in California)
- The Clutch Disc
- Brake Pads and Linings
- Shock Absorbers
- Belts and Hoses
- Diesel Exhaust Fluid Replenishment

Contact your selling authorized Ford or Lincoln dealership today so they can customize a Ford Extended Service Plan that fits your driving lifestyle and budget.

## Interest Free Finance Options Available

Take advantage of our interest free installment payment plan. Just a 10% down payment will provide you with an affordable, no interest, no fee payment program.

To learn more, call our Ford ESP specialists at 800-367-3377. Don't forget to ask about our interest free payment program, allowing you all the security and benefits Ford ESP has to offer while paying over time. You are pre-approved with no credit checks, no hassles!

Complete the information below and mail to:

Ford ESP  
P.O. Box 8072  
Royal Oak, MI 48068-0039

<b>Name (PLEASE PRINT)</b>		
<b>ADDRESS</b>	<b>APT.#</b>	
<b>CITY</b>	<b>STATE</b>	<b>ZIP</b>
<b>E-MAIL</b>		

# Ford Extended Service Plan (ESP)

---

## SERVICE PLANS (CANADA ONLY)

You can get more protection for your vehicle by purchasing a Ford Extended Service Plan. Ford Extended Service Plan is the only service contract backed by Ford Motor Company of Canada, Limited. Depending on the plan you purchase, Ford Extended Service Plan provides benefits such as:

- Rental reimbursement
- Coverage for certain maintenance and wear items
- Protection against repair costs after your New Vehicle Limited Warranty Coverage expires
- Roadside Assistance benefits

There are several Ford Extended Service Plans available in various time, distance and deductible combinations. Each plan is tailored to fit your own driving needs, including reimbursement for towing and rental.

When you purchase Ford Extended Service Plan, you receive added peace-of-mind protection throughout Canada and the United States, provided by a network of participating authorized Ford Motor Company dealers. The Lincoln Maintenance Protection Plan is honored at authorized Lincoln dealers.

**Note:** *Repairs performed outside of Canada and the United States are not eligible for Ford Extended Service Plan coverage.*

This information is subject to change.

For more information, visit your local Ford of Canada dealer or [www.ford.ca](http://www.ford.ca) to find the Ford Extended Service Plan that is right for you.

# Audio System

## GENERAL INFORMATION

### Radio Frequencies and Reception Factors

Radio reception factors	
Distance and Strength	The further you travel away from an FM station, the weaker the signal and the weaker the reception.
Terrain	Hills, mountains, tall buildings, bridges, tunnels, freeway overpasses, parking garages, dense tree foliage and thunderstorms can interfere with the reception.
Station overload	When you pass near a radio transmission tower, a stronger signal can override a weaker signal and can cause interference in the audio system.

### CD and CD Player Information

**Note:** *CD units play commercially pressed 4.75-inch (12 centimeter) audio compact discs only. Due to technical incompatibility, certain recordable and re-recordable compact discs may not function correctly when used in Ford CD players.*

**Note:** *Do not insert CDs with homemade paper (adhesive) labels into the CD player as the label may peel and cause the CD to become jammed. You should use a permanent felt tip marker rather than adhesive labels on your homemade CDs. Ballpoint pens may damage CDs. Please contact an authorized dealer for further information.*

**Note:** *Do not use any irregularly shaped discs or discs with a scratch protection film attached.*

Always handle discs by their edges only. Clean the disc with an approved CD cleaner only. Wipe it from the center of the disc toward the edge. Do not clean in a circular motion.

Do not expose discs to direct sunlight or heat sources for extended periods.

### MP3 and WMA Track and Folder Structure

Audio systems capable of recognizing and playing MP3 and WMA individual tracks and folder structures work as follows:

- There are two different modes for MP3 and WMA disc playback: MP3 and WMA track mode (system default) and MP3 and WMA folder mode.
- MP3 and WMA track mode ignores any folder structure on the MP3 and WMA disc. The player numbers each MP3 and WMA track on the disc (noted by the .mp3 or .WMA file extension) from T001 to a maximum of T255. The maximum number of playable MP3 and WMA files may be less depending on the structure of the CD and exact model of radio present.

# Audio System

---

- MP3 and WMA folder mode represents a folder structure consisting of one level of folders. The CD player numbers all MP3 and WMA tracks on the disc (noted by the .mp3 or .WMA file extension) and all folders containing MP3 and WMA files, from F001 (folder) T001 (track) to F253 T255.
- Creating discs with only one level of folders helps with navigation through the disc files.

If you are burning your own MP3 and WMA discs, it is important to understand how the system reads the structures you create. While various files may be present, (files with extensions other than mp3 and WMA), only files with the .mp3 and WMA extension are played; other files are ignored by the system. This enables you to use the same MP3 and WMA disc for a variety of tasks on your work computer, home computer and your in-vehicle system.

In track mode, the system displays and plays the structure as if it were only one level deep (all .mp3 files play, regardless of being in a specific folder). In folder mode, the system only plays the .mp3 files in the current folder.

## **AUDIO UNIT - VEHICLES WITH: AM/FM/CD**

### **WARNING**



Driving while distracted can result in loss of vehicle control, crash and injury. We strongly recommend that you use extreme caution when using any device that may take your focus off the road. Your primary responsibility is the safe operation of your vehicle. We recommend against the use of any handheld device while driving and encourage the use of voice-operated systems when possible. Make sure you are aware of all applicable local laws that may affect the use of electronic devices while driving.

---



# Audio System

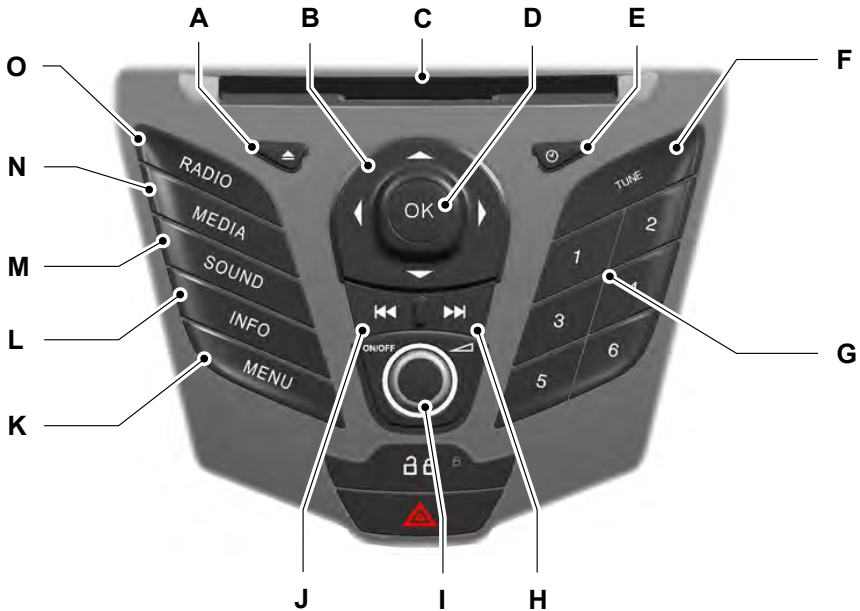

E156613

- A **Eject:** Press the button to eject a CD.
- B **Cursor arrows:** Press a button to scroll through on-screen choices.
- C **CD slot:** Where you insert a CD.
- D **OK:** Press the button to confirm on-screen selections.
- E **Clock:** Press to set the time. Use the **H** and **M** buttons outside the audio display to adjust the hours and minutes. Press **OK** to finish. (The clock can also be set by pressing **MENU**, then scrolling to the clock settings menu.)
- F **Tune:** Press the button to manual tune on AM and FM wavebands.
- G **Numeric keypad:** Press the button to recall a previously stored station. To store a favorite station press and hold until the sound returns.
- H **Seek up:** Press the button to go to the next station up the radio frequency band or the next track on a CD.
- I **On, Off and Volume:** Press the button to switch the audio system on or off. Turn the dial to adjust the volume.

# Audio System

---

- J **Seek down:** Press the button to go to the next station down the radio frequency band or the previous track on a CD.
- K **MENU:** Press the button to access different audio system features.
- L **INFO:** Press the button to access radio or CD information.
- M **SOUND:** Press the button to adjust the sound settings for bass, treble, middle, balance and fade.
- N **MEDIA:** Press the button to access the AUX and SYNC features, it will also cancel the menu or list browsing.
- O **RADIO:** Press the button to select different radio bands, it will also cancel the menu or list browsing.

## Sound Button

This will allow you to adjust the sound settings (for example bass, middle and treble).

1. Press the **SOUND** button.
2. Use the up and down arrow buttons to select the required setting.
3. Use the left and right arrow buttons to make the necessary adjustment. The display indicates the level selected.
4. Press the **OK** button to confirm the new settings.

## Waveband Button

Press the **RADIO** button to select from the wavebands available.

You can use the selector to return to radio reception when you have been listening to another source.

Alternatively, press the left arrow button to display the available wavebands. Scroll to the required waveband and press **OK**.

## Station Tuning Control

### Seek Tuning

Select a waveband and briefly press one of the seek buttons. The unit will stop at the first station it finds in the direction you have chosen.

### Manual Tuning

1. Press the **MENU** button.
2. Select **RADIO** mode and then **Manual**.
3. Use the left and right arrow buttons to tune down or up the waveband in small increments or press and hold to increment quickly, until you find a station you want to listen to.
4. Press **OK** to continue listening to a station.

### Scan Tuning

Scan allows you to listen to a few seconds of each station detected.

1. Press the **MENU** button.
2. Select **RADIO** mode and then **Scan**.
3. Use the seek buttons to scan up or down the selected waveband.
4. Press **OK** to continue listening to a station.

# Audio System

---

## Station Preset Buttons

This feature allows you to store your favorite stations, they can be recalled by selecting the appropriate waveband and pressing one of the preset buttons.

1. Select a waveband.
2. Tune to the station required.
3. Press and hold one of the preset buttons. A progress bar and message will appear. When the progress bar completes the station has been stored. The audio unit will also mute momentarily as confirmation.

You can repeat this on each waveband and for each preset button.

**Note:** *When you drive to another part of the country, stations that broadcast on alternative frequencies and are stored on preset buttons, may be updated with the correct frequency and station name for that area.*

## Autostore Control

**Note:** *This will store up to a maximum of the six strongest signals available, either from the AM or the FM waveband and overwrite the previously stored stations. You can also store stations manually in the same way as other wavebands.*

- Press and hold the **RADIO** button.
- When the search is complete, sound is restored and the strongest signals are stored on the autostore presets.

## Automatic Volume Control

When available, automatic volume control adjusts the volume level to compensate for engine noise and road speed noise.

1. Press the **MENU** button and select **Audio Settings**.
2. Select **Spd. Comp. Vol.**

3. Use the left or right arrow button to adjust the setting.
4. Press the **OK** button to confirm your selection.
5. Press the **MENU** button to return.

## News Broadcasts

Your audio unit may interrupt normal reception to broadcast news bulletins from stations on the FM waveband, radio data system or other enhanced network linked stations.

The display will indicate there is an incoming announcement during news broadcasts. When the audio unit interrupts for a news broadcast the preset volume level will be the same as traffic announcements.

1. Press the **MENU** button.
2. Select **Audio Settings**.
3. Scroll to **News** and turn on or off with the **OK** button.
4. Press the **MENU** button to return.

## Alternative Frequencies

The majority of programs that broadcast on the FM waveband have a program identification code that can be recognized by audio units.

When your vehicle moves from one transmission area to another with the alternative frequencies tuning switched on, this function will search for the strongest station signal.

Under certain conditions, alternative frequencies tuning may temporarily disrupt normal reception.

# Audio System

---

When selected, the unit continually evaluates signal strength and if a better signal becomes available, the unit will switch to that alternative. It mutes while it checks a list of alternative frequencies and if necessary, it will search once across the selected waveband for a genuine alternative frequency.

It will restore radio reception when it finds one or if one is not found, the unit will return to the original stored frequency.

When selected, **AF** will be shown in the display.

1. Press the **MENU** button.
2. Select **Audio Settings**.
3. Scroll to **Alternat. freq.** or **Alt. Frequency** and turn on or off with the **OK** button.
4. Press the **MENU** button to return.

## Regional Mode

Regional mode controls the behavior of alternative frequencies switching between regionally related networks of a parent broadcaster. A broadcaster may run a fairly large network across a large part of the country. At various times of the day this large network may be broken down into a number of smaller regional networks, typically centered on major towns or cities. When the network is not split into regional variants, the whole network carries the same programming.

Regional mode ON: This prevents random alternative frequency switches when neighboring regional networks are not carrying the same programming.

Regional mode OFF: This allows a larger coverage area if neighboring regional networks are carrying the same programming, but can cause random alternative frequency switches if they are not.

1. Press the **MENU** button.
2. Select **Audio Settings**.
3. Scroll to **RDS regional** and turn on or off with the **OK** button.
4. Press the **MENU** button to return.

## AUDIO UNIT - VEHICLES WITH: AM/FM/CD/SYNC

### WARNING



Driving while distracted can result in loss of vehicle control, crash and injury. We strongly recommend that you use extreme caution when using any device that may take your focus off the road. Your primary responsibility is the safe operation of your vehicle. We recommend against the use of any handheld device while driving and encourage the use of voice-operated systems when possible. Make sure you are aware of all applicable local laws that may affect the use of electronic devices while driving.

**Note:** *An integrated multi function display is situated above the unit. This shows important information regarding control of your system. Additionally, there are various icons placed around the display screen which light up when a function is active (for example CD, Radio or Aux).*

# Audio System

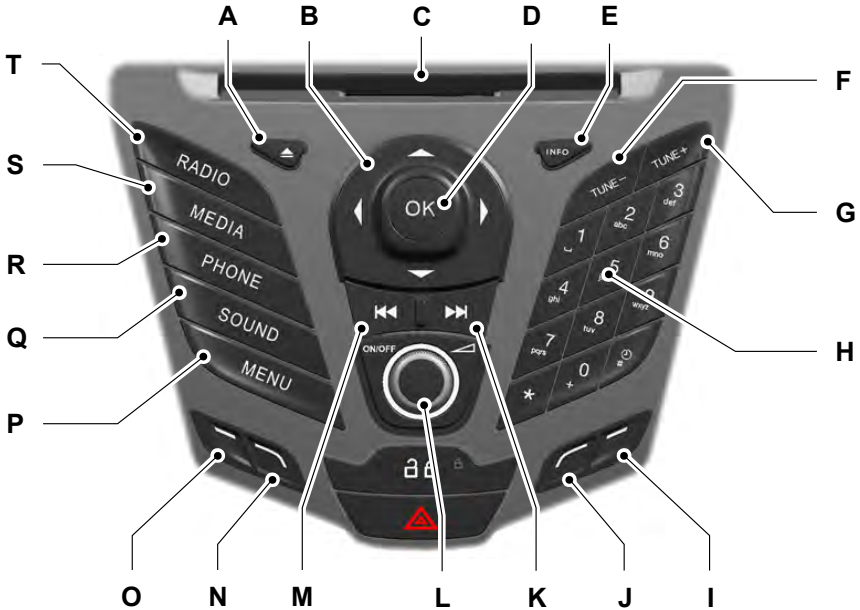

E156629

- A **Eject:** Press the button to eject a CD.
- B **Cursor arrows:** Press a button to scroll through on-screen choices.
- C **CD slot:** Where you insert a CD.
- D **OK:** Press the button to confirm on-screen selections.
- E **INFO:** Press the button to access radio, CD, USB and iPod information.
- F **TUNE -:** Press the button to manual tune down the waveband.
- G **TUNE +:** Press the button to manual tune up the waveband.
- H **Numeric keypad:** Press the button to recall a previously stored station. To store a favorite station press and hold until the sound returns.
- I **Function button 4:** Press the button to select different functions of the audio system depending on which mode (i.e. radio or CD) you are in.
- J **Function button 3:** Press the button to select different functions of the audio system depending on which mode (i.e. radio or CD) you are in.

# Audio System

- K Seek up:** Press the button to go to the next station up the radio frequency band or the next track on a CD.
- L On, Off and Volume:** Press the button to switch the audio system on or off. Turn the dial to adjust the volume.
- M Seek down:** Press the button to go to the next station down the radio frequency band or the previous track on a CD.
- N Function button 2:** Press the button to select different functions of the audio system depending on which mode (i.e. radio or CD) you are in.
- O Function button 1:** Press the button to select different functions of the audio system depending on which mode (i.e. radio or CD) you are in.
- P MENU:** Press the button to access different audio system features.
- Q SOUND:** Press the button to adjust the sound settings for bass, treble, middle, balance and fade.
- R PHONE:** Press the button to access the phone feature of the SYNC system by pressing **PHONE** then **MENU**. See separate manual.
- S MEDIA:** Press the button to access the AUX and SYNC features, it will also cancel the menu or list browsing.
- T RADIO:** Press the button to select different radio bands, it will also cancel the menu or list browsing.

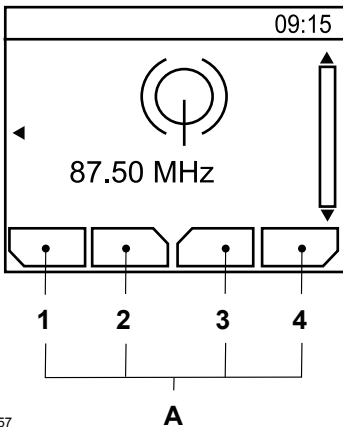

E104157

- A** Descriptions for function buttons 1-4

Function buttons 1 to 4 are context dependent, and change according to the current unit mode. The description for the current function displays in the screen.

## Sound Button

This will allow you to adjust the sound settings (for example bass, middle and treble).

1. Press the **SOUND** button.
2. Use the up and down arrow buttons to select the required setting.
3. Use the left and right arrow buttons to make the necessary adjustment. The display indicates the level selected.
4. Press the **OK** button to confirm the new settings.

# Audio System

---

## Waveband Button

Press the **RADIO** button to select from the wavebands available.

You can use the selector to return to radio reception when you have been listening to another source.

Alternatively, press the left arrow button to display the available wavebands. Scroll to the required waveband and press **OK**.

## Station Tuning Control

### Seek Tuning

Select a waveband and briefly press one of the seek buttons. The unit will stop at the first station it finds in the direction you have chosen.

### Manual Tuning

1. Press **function button 2**.
2. Use the left and right arrow buttons to tune down or up the waveband in small increments or press and hold to increment quickly, until you find a station you want to listen to.
3. Press **OK** to continue listening to a station.

### Scan Tuning

Scan allows you to listen to a few seconds of each station detected.

1. Press **function button 3**.
2. Use the seek buttons to scan up or down the selected waveband.
3. Press **function button 3** again or **OK** to continue listening to a station.

## Station Preset Buttons

This feature allows you to store your favorite stations, they can be recalled by selecting the appropriate waveband and pressing one of the preset buttons.

1. Select a waveband.
2. Tune to the station required.
3. Press and hold one of the preset buttons. A progress bar and message will appear. When the progress bar completes the station has been stored. The audio unit will also mute momentarily as confirmation.

You can repeat this on each waveband and for each preset button.

**Note:** *When you drive to another part of the country, stations that broadcast on alternative frequencies, and are stored on preset buttons, may be updated with the correct frequency and station name for that area.*

## Autostore Control

**Note:** *This will store up to a maximum of the 10 strongest signals available, either from the AM or the FM waveband, and overwrite the previously stored stations. You can also store stations manually in the same way as other wavebands.*

- Press and hold the **RADIO** button.
- When the search is complete, sound is restored and the strongest signals are stored on the autostore presets.

## Automatic Volume Control

When available, automatic volume control adjusts the volume level to compensate for engine noise and road speed noise.

1. Press the **MENU** button and select **Audio Settings**.
2. Select **Spd. Comp. Vol.**
3. Use the left or right arrow button to adjust the setting.
4. Press the **OK** button to confirm your selection.
5. Press the **MENU** button to return.

# Audio System

---

## News Broadcasts

Your audio unit may interrupt normal reception to broadcast news bulletins from stations on the FM waveband, radio data system or other enhanced network linked stations.

The display will indicate there is an incoming announcement, during news broadcasts. When the audio unit interrupts for a news broadcast the preset volume level will be the same as traffic announcements.

1. Press the **MENU** button.
2. Select **Audio Settings**.
3. Scroll to **News** and turn on or off with the **OK** button.
4. Press the **MENU** button to return.

## Alternative Frequencies

The majority of programs that broadcast on the FM waveband have a program identification code, it can be recognized by audio units.

When your vehicle moves from one transmission area to another with the alternative frequencies tuning switched on, this function will search for the strongest station signal.

Under certain conditions, alternative frequencies tuning may temporarily disrupt normal reception.

When selected, the unit continually evaluates signal strength and, if a better signal becomes available, the unit will switch to that alternative. It mutes while it checks a list of alternative frequencies and if necessary, it will search once across the selected waveband for a genuine alternative frequency.

It will restore radio reception when it finds one or if one is not found, the unit will return to the original stored frequency.

When selected, **AF** will be shown in the display.

1. Press the **MENU** button.
2. Select **Audio Settings**.
3. Scroll to **Alternat. freq.** or **Alt. Frequency** and turn on or off with the **OK** button.
4. Press the **MENU** button to return.

## Regional Mode

Regional mode controls the behavior of alternative frequencies switching between regionally related networks of a parent broadcaster. A broadcaster may run a fairly large network across a large part of the country. At various times of the day this large network may be broken down into a number of smaller regional networks, typically centered on major towns or cities. When the network is not split into regional variants, the whole network carries the same programming.

Regional mode ON: This prevents random alternative frequency switches when neighboring regional networks are not carrying the same programming.

Regional mode OFF: This allows a larger coverage area if neighboring regional networks are carrying the same programming, but can cause random alternative frequency switches if they are not.

1. Press the **MENU** button.
2. Select **Audio Settings**.
3. Scroll to **RDS regional** and turn on or off with the **OK** button.
4. Press the **MENU** button to return.



# Audio System

## AUDIO UNIT - VEHICLES WITH: TOUCHSCREEN DISPLAY

**Note:** The MyFord Touch® system controls most of the audio features. See **MyFord Touch™** (page 295).

### WARNING

 Driving while distracted can result in loss of vehicle control, crash and injury. We strongly recommend that you use extreme caution when using any device that may take your focus off the road. Your primary responsibility is the safe operation of your vehicle. We recommend against the use of any handheld device while driving and encourage the use of voice-operated systems when possible. Make sure you are aware of all applicable local laws that may affect the use of electronic devices while driving.

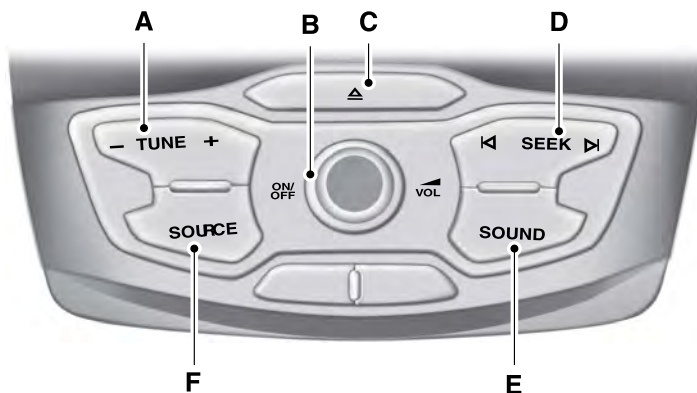

E143843

- A **Tune:** Press these buttons when in radio mode to manually search up or down through the radio frequency band. In SIRIUS mode, press these buttons to find the next or previous available satellite radio station.
- B **On, Off and Volume:** Press the button to switch the audio system on or off. Turn the dial to adjust the volume.
- C **Eject:** Press the button to eject a CD.

# Audio System

---

- D **SEEK** Press these buttons when you are in radio mode to go to the next station up or down the radio frequency band, or to go to the next or previous track on a CD. In SIRIUS mode, press these buttons to select the next or previous channel. If a specific category is selected (for example Jazz, Rock or News), use these buttons to find the next or previous channel in the selected category.
- E **SOUND:** Press the button to adjust the sound settings for bass, treble, middle, balance and fade.
- F **SOURCE:** Press the button to access different audio modes, such as AM, FM and A/V input.

**Note:** *The MyFord Touch® system controls most of the audio features. See **MyFord Touch™** (page 295).*

## **AUDIO UNIT - VEHICLES WITH: SONY AUDIO SYSTEM/ TOUCHSCREEN DISPLAY**

### **WARNING**



Driving while distracted can result in loss of vehicle control, crash and injury. We strongly recommend that you use extreme caution when using any device that may take your focus off the road. Your primary responsibility is the safe operation of your vehicle. We recommend against the use of any handheld device while driving and encourage the use of voice-operated systems when possible. Make sure you are aware of all applicable local laws that may affect the use of electronic devices while driving.

---

# Audio System

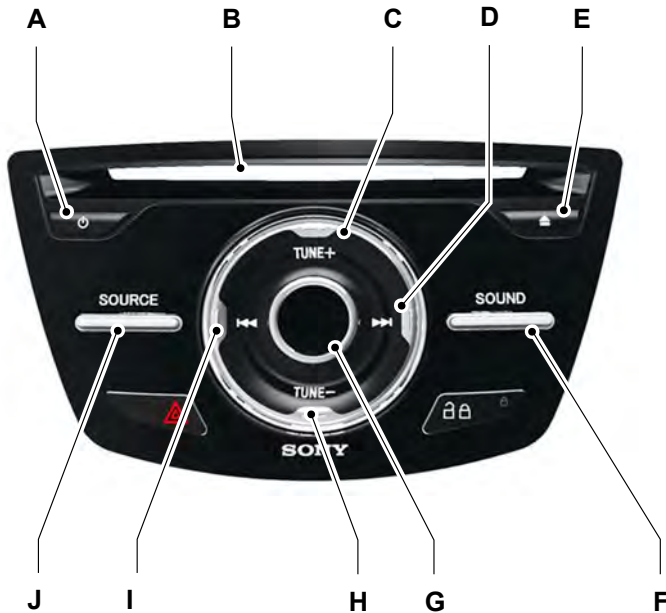

E156663

- A **On, Off:** Press the button to switch the audio system on or off.
- B **CD Slot** Where you insert a CD.
- C **TUNE +:** In radio mode, press this button to manually search forward through the radio frequency band. In SIRIUS mode, press this button to find the next available satellite radio station.
- D **Seek up** In radio mode, press this button to go to the next station up the radio frequency band. Press to go to the next track on a CD. In SIRIUS mode, press this button to select the next channel. If a specific category is selected (for example Jazz, Rock or News), use this button to find the next channel in the selected category.
- E **Eject:** Press the button to eject a CD.
- F **SOUND:** Press the button to adjust the sound settings for bass, treble, middle, balance and fade.
- G **Volume** Turn the dial to adjust the volume.

# Audio System

- H **TUNE-:** In radio mode, press this button to manually search backward through the radio frequency band. In SIRIUS mode, press this button to find the previous available satellite radio station.
- I **Seek down** In radio mode, press this button to go to the next station down the radio frequency band. Press to go to the previous track on a CD. In SIRIUS mode, press this button to select the previous channel. If a specific category is selected (for example Jazz, Rock or News), use this button to find the previous channel in the selected category.
- J **SOURCE:** Press the button to access different audio modes, such as AM, FM and A/V input.

## AUXILIARY INPUT JACK

### WARNINGS



Driving while distracted can result in loss of vehicle control, crash and injury. We strongly recommend that you use extreme caution when using any device that may take your focus off the road. Your primary responsibility is the safe operation of your vehicle. We recommend against the use of any hand-held device while driving and encourage the use of voice-operated systems when possible. Make sure you are aware of all applicable local laws that may affect the use of electronic devices while driving.



For safety reasons, do not connect or adjust the settings on your portable music player while your vehicle is moving.



Store the portable music player in a secure location, such as the center console or the glove box, when your vehicle is moving. Hard objects may become projectiles in a collision or sudden stop, which may increase the risk of serious injury. The audio extension cable must be long enough to allow the portable music player to be safely stored while your vehicle is moving.



E149149

The auxiliary input jack allows you to connect and play music from your portable music player through your vehicle speakers. You can use any portable music player designed for use with headphones. Your audio extension cable must have male 1/8th-inch (3.5 millimeter) connectors at each end.

1. Switch off the engine, radio and portable music player. Set the parking brake and put the transmission in position **P** (vehicle with an automatic transmission) or neutral (vehicle with a manual transmission).
2. Plug the extension cable from the portable music player into the auxiliary input jack.
3. Switch the radio on. Select either a tuned FM station or a CD.
4. Adjust the volume as desired.

# Audio System

---

5. Switch your portable music player on and adjust its volume to half its maximum level.
6. Press **AUX** until **LINE** or **LINE IN** appears in the display. You should hear music from your device even if it is low.
7. Adjust the volume on your portable music player until it reaches the volume level of the FM station or CD. Do this by switching back and forth between the AUX and FM or CD controls.

## AUDIO TROUBLESHOOTING

Audio unit display	Rectification
PLEASE CHECK CD	General error message for CD fault conditions, such as cannot read the CD, data-CD inserted, etc. Make sure the disc is loaded correct way up. Clean and re-try, or replace disc with known music disc. If error persists contact your dealer.
CD DRIVE MALFUNCTION	General error message for CD fault conditions such as possible mechanism fault.
CD DRIVE HIGH TEMP	Ambient temperature too hot – unit will not work until it has cooled down.

## GENERAL INFORMATION

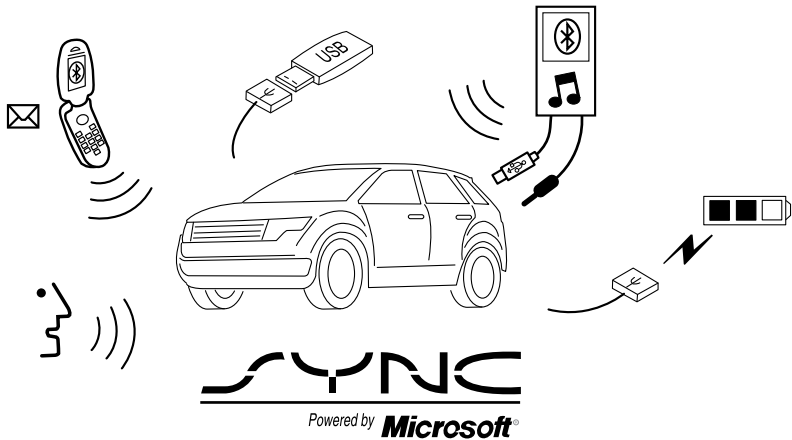

E142598

SYNC is an in-vehicle communications system that works with your Bluetooth-enabled cellular phone and portable media player. This allows you to:

- Make and receive calls.
- Access and play music from your portable music player.
- Use 911 Assist, Vehicle Health Report and SYNC Services (Traffic, Directions & Information).\*
- Use applications, such as Pandora and Stitcher, via SYNC AppLink.
- Access phonebook contacts and music using voice commands.
- Stream music from your connected phone.
- Text message.

- Use the advanced voice recognition system
- Charge your USB device (if your device supports this).

\*These features require activation.

Make sure that you review your device's manual before using it with SYNC.

### Support

The SYNC support team is available to help you with any questions you cannot answer on your own.

Monday-Saturday, 8:30am-9:00pm EST.

Sunday, 10:30am-7:30pm EST.

In the United States, call 1-800-392-3673.

In Canada, call 1-800-565-3673.

Times are subject to change due to holidays.

## SYNC Owner Account

Why do I need a SYNC owner account?

- Required to activate Vehicle Health Report and to view the reports online.
- Required to activate the subscription-based SYNC Services and to personalize your Saved Points and Favorites.
- Essential for keeping up with the latest software downloads available for SYNC.
- Access to customer support for any questions you may have.

## Driving Restrictions

For your safety, certain features are speed-dependent and restricted when your vehicle is traveling over 3 mph (5 km/h).

## Safety Information

### WARNING



Driving while distracted can result in loss of vehicle control, crash and injury. We strongly recommend that you use extreme caution when using any device that may take your focus off the road. Your primary responsibility is the safe operation of your vehicle. We recommend against the use of any hand-held device while driving and encourage the use of voice-operated systems when possible. Make sure you are aware of all applicable local laws that may affect the use of electronic devices while driving.

---

When using SYNC:

- Do not operate playing devices if the power cords or cables are broken, split or damaged. Place cords and cables out of the way, so they do not interfere with the operation of pedals, seats, compartments or safe driving abilities.
- Do not leave playing devices in your vehicle during extreme conditions as it could cause them damage. See your device's manual for further information.
- Do not attempt to service or repair the system. See an authorized dealer.

## Privacy Information

When a cellular phone is connected to SYNC, the system creates a profile within your vehicle that is linked to that cellular phone. This profile is created in order to offer you more cellular features and to operate more efficiently. Among other things, this profile may contain data about your cellular phone book, text messages (read and unread), and call history, including history of calls when your cellular phone was not connected to the system. In addition, if you connect a media device, the system creates and retains an index of supported media content. The system also records a short development log of approximately 10 minutes of all recent system activity. The log profile and other system data may be used to improve the system and help diagnose any problems that may occur.

The cellular profile, media device index, and development log will remain in the vehicle unless you delete them and are generally accessible only in the vehicle when the cellular phone or media player is connected. If you no longer plan to use the system or the vehicle, we recommend you perform a Master Reset to erase all stored information.

System data cannot be accessed without special equipment and access to the vehicle's SYNC module. Ford Motor Company and Ford of Canada will not access the system data for any purpose other than as described absent consent, a court order, or where required by law enforcement, other government authorities, or other third parties acting with lawful authority. Other parties may seek to access the information independently of Ford Motor Company and Ford of Canada. For further privacy information, see the sections on 911 Assist, Vehicle Health Report, and Traffic, Directions and Information.

## USING VOICE RECOGNITION

This system helps you control many features using voice commands. This allows you to keep your hands on the wheel and focus on what is in front of you.

### Initiating a Voice Session



Push the voice icon. A tone sounds and Listening appears in the display. Say any of the following:

Say	If You Want To
"Bluetooth audio"	Stream audio from your phone.
"Cancel"	Cancel the requested action.
"Line in"	Access the device connected to the auxiliary input jack.
"Mobile apps" *	Access mobile applications.
"Phone"	Make calls.
"Services" *	Access the SYNC Services portal.
"SYNC"	Return to the main menu.
"USB"	Access the device connected to your USB port.
"Vehicle health report" *	Run a vehicle health report.
"Voice settings"	Adjust the level of voice interaction and feedback.
"Help"	Hear a list of voice commands available in the current mode.

\* This is an optional feature and available in the United States only.



## System Interaction and Feedback

The system provides feedback through audible tones, prompts, questions and spoken confirmations depending on the situation and the chosen level of interaction (voice settings). You can customize the voice recognition system to provide more or less instruction and feedback.

The default setting is to a higher level of interaction in order to help you learn to use the system. You can change these settings at any time.

### Adjusting the Interaction Level



Push the voice icon. Say "Voice settings" when prompted, then any of the following:

When you say:	The system:
"Interaction mode standard"	Provides more detailed interaction and guidance.
"Interaction mode advanced"	Provides less audible interaction and more tone prompts.

The system defaults to the standard interaction mode.

Confirmation prompts are short questions the system asks when it is not sure of your request or when there are multiple possible responses to your request. For example, the system may ask "Phone, is that correct?". If turned off, the system simply makes a best guess as to what you requested and may ask you to confirm settings.

When you say:	The system:
"Confirmation prompts off"	Makes a best guess from the command; you may still occasionally be asked to confirm settings.
"Confirmation prompts on"	Clarifies your voice command with a short question.

The system creates candidate lists when it has the same confidence level of several options based on your voice command. When turned on, it may prompt you with as many as four possibilities for clarification.

For example, say "Say 1 after the tone to call John Doe at home. Say 2 after the tone to call Johnny Doe on mobile. Say 3 after the tone to call Jane Doe at home." You could also say "Say 1 after the tone to play John Doe, Say 2 after the tone to play Johnny Doe."

<b>When you say:</b>	<b>The system:</b>
"Media candidate lists off"	Makes a best guess from the media candidate list. You may still occasionally be asked questions.
"Media candidate lists on"	Clarifies your voice command for media candidates.
"Phone candidate lists off"	Makes a best guess from the phone candidate list. You may still occasionally be asked questions.
"Phone candidate lists on"	Clarifies your voice command for phone candidates

## Helpful Hints

- Make sure the interior of your vehicle is as quiet as possible. Wind noise from open windows and road vibrations may prevent the system from correctly recognizing spoken commands.
- After pressing the voice icon, wait until after the tone sounds and Listening appears before saying a command. Any command spoken before this does not register with the system.
- Speak naturally, without long pauses between words.
- At any time, you can interrupt the system while it is speaking by pressing the voice icon.

## USING SYNC™ WITH YOUR PHONE

Hands-free calling is one of the main features of SYNC. While the system supports a variety of features, many are dependent on your cellular phone's functionality. At a minimum, most cellular phones with Bluetooth wireless technology support the following functions:

- Answering an incoming call.
- Ending a call.
- Using privacy mode.
- Dialing a number.
- Redialing.
- Call waiting notification.
- Caller ID.

Other features, such as text messaging using Bluetooth and automatic phonebook download, are phone-dependent features. To check your phone's compatibility, see your phone's manual and visit [www.SYNCMYRide.com](http://www.SYNCMYRide.com), [www.SYNCMYRide.ca](http://www.SYNCMYRide.ca) or [www.syncmaroute.ca](http://www.syncmaroute.ca).

## Pairing a Phone for the First Time

**Note:** SYNC can support downloading up to approximately 1000 entries per Bluetooth-enabled cellular phone.

**Note:** Make sure to switch on the ignition and the radio. Put the transmission in position **P**.

**Note:** To scroll through the menus, press the up and down arrows on your audio system.

Wirelessly pairing your phone with SYNC allows you to make and receive hands-free calls.

1. Press the phone button. When the display indicates there is no phone paired, press **OK**.
2. When **Find SYNC** appears in the display, press **OK**.
3. Put your phone into Bluetooth discovery mode. See your device's manual if necessary.
4. When prompted on your phone's display, enter the six-digit PIN provided by SYNC in the radio display. The display indicates when the pairing is successful.

Depending on your phone's capability and your market, the system may prompt you with questions, such as setting the current phone as the primary phone (the phone SYNC automatically tries to connect with first upon vehicle start-up) and downloading your phonebook.

## Pairing Subsequent Phones

**Note:** Make sure to switch on the ignition and the radio. Put the transmission in position **P**.

**Note:** To scroll through the menus, press the up and down arrows on your audio system.

1. Press the phone button, and then scroll to System Settings. Press **OK**.
2. Scroll to Bluetooth Devices. Press **OK**.
3. Scroll to Add Bluetooth Device. Press **OK**.
4. When **Find SYNC** appears in the display, press **OK**.
5. Put your phone into Bluetooth discovery mode. See your phone's manual if necessary.
6. When prompted on your phone's display, enter the six-digit PIN provided by SYNC in the radio display. The display indicates when the pairing is successful.

The system then prompts with questions, such as if you would like to set the current phone as the primary phone (the phone SYNC automatically tries to connect with first upon vehicle start-up) and download your phone book.

## Phone Voice Commands

Press the voice icon and say "Phone". Say any of the following:

"PHONE"
"Call <name>" <sup>1,2</sup>
"Call <name> at home" <sup>1,2</sup>
"Call <name> at work" <sup>1,2</sup>
"Call <name> in office" <sup>1,2</sup>
"Call <name> on mobile OR cell" <sup>1,2</sup>
"Call <name> on other" <sup>1,2</sup>
"Call history incoming" <sup>2</sup>
"Call history missed" <sup>2</sup>

"PHONE"
"Call history outgoing" <sup>2</sup>
"Connections" <sup>2</sup>
"Dial" <sup>1,3</sup>
"Go to privacy"
"Hold"
"Join"
"Menu" <sup>2,4</sup>
"Phone book <name>" <sup>2</sup>
"Phone book <name> at home" <sup>2</sup>
"Phone book <name> at office" <sup>2</sup>
"Phone book <name> at work" <sup>2</sup>
"Phone book <name> on mobile OR cell" <sup>2</sup>
"Phone book <name> on other" <sup>2</sup>

<sup>1</sup> This command does not require you to say "Phone" first.

<sup>2</sup> This command is not available until phone information is completely downloaded using Bluetooth.

<sup>3</sup> See **Dial** table below.

<sup>4</sup> See **Menu** table below.

**Phone book commands:** When you ask SYNC to access things such as a phonebook name or number, the requested information appears in the display to view. Press the phone button and say, "Call" to call the contact.

"DIAL"
"411 (four-one-one)", "911" (nine-one-one)
"700" (seven hundred)
"800" (eight hundred)
"900" (nine hundred)
"Pound" (#)
"Number <0-9>"
"Asterisk" (*)
"Clear" (deletes all entered digits)
"Delete" (deletes one digit)
"Plus"
"Star"

**Note:** To exit dial mode, press and hold the phone button or press **MENU** to go to the phone menu.

"MENU"
"(Phone) connections"
"(Phone) settings (message) notification off"
"(Phone) settings (message) notification on"
"(Phone) settings (set) phone ringer"
"(Phone) settings (set) ringer 1"
"(Phone) settings (set) ringer 2"
"(Phone) settings (set) ringer 3"
"(Phone) settings (set) ringer off"
"Battery"
"Phone name"

<b>"MENU"</b>
"Signal"
"Text message inbox"

Words in ( ) are optional and do not have to be spoken for the system to understand the command.

## Making Calls

Press the voice icon and when prompted say:

1. Say "Call <name>" or "Dial", then the desired number.
2. When the system confirms the number, say, "Dial" again to initiate the call.

To erase the last spoken digit, say, "Delete" or press the left arrow button. To erase all spoken digits, say "Clear" or press and hold the left arrow button.

To end the call, press and hold the phone button.

## Receiving Calls

When receiving a call, you can:

- Answer the call by pressing the phone button.
- Reject the call by pressing and holding the phone button.
- Ignore the call by doing nothing.

## Phone Options during an Active Call

During an active call, you have more menu features that become available, such as putting a call on hold or joining calls. Use the arrow buttons to scroll through the menu options.

1. Press **MENU** during an active call.
2. After selecting Active Call Menu, press **OK**.
3. Scroll to cycle through the following options:

<b>When you select:</b>	<b>You can:</b>
Mute Call?	Mute the call.
Privacy	Switch a call from an active hands-free environment to your cellular phone for a more private conversation. Press <b>OK</b> when <b>Privacy on/off</b> appears. (The display indicates In Privacy and the system transfers your call.)
Call Hold	Put an active call on hold. Press <b>OK</b> when <b>Hold on/off</b> appears. To answer another call at this time, press the phone button.
Enter Tones	Enter "tones", such as numbers for passwords. Scroll until the desired number appears in the display, then press <b>OK</b> ; a tone sounds as confirmation. Repeat as necessary.
Join Calls	Join two separate calls. (SYNC supports a maximum of three callers on a multiparty call or conference call.) 1. Press the phone button.

When you select:	You can:
	2. Access the desired contact through SYNC or use voice commands to place the second call. Once actively in the second call, press <b>MENU</b> . 3. Scroll to Join Calls, and press <b>OK</b> . Press <b>OK</b> again when <b>Join Calls?</b> appears.
Phonebook	Access your phonebook contacts. 1. Press <b>OK</b> to select, and then scroll through your phonebook contacts. 2. Press <b>OK</b> again when the desired selection appears in the display. 3. Press the phone button.
Call History	Access your call history log. 1. Press <b>OK</b> to select, then scroll through your call history options (incoming, outgoing or missed). 2. Press <b>OK</b> when the desired selection appears in the display. 3. Press the phone button to call the selection.
Return	Exit the current menu.

## Accessing Features through the Phone Menu

SYNC's phone menu allows you to redial a number, access your call history and phonebook and sends text messages as well as access phone and system settings. You can also access advanced features, such as 911 Assist, Vehicle Health Report and SYNC Services.

1. Press the phone button to enter the phone menu.
2. Scroll to cycle through:

When you select:	You can:
Phone Redial	Redial the last number called (if available). Press <b>OK</b> to select, and then press <b>OK</b> again to confirm.
Call History <sup>1</sup>	Access any previously dialed, received or missed calls after you connect your Bluetooth-enabled phone to SYNC. 1. Press <b>OK</b> to select. 2. Scroll to select from Call History Incoming, Call History Outgoing or Call History Missed. Press <b>OK</b> to make your selection. 3. Press <b>OK</b> or the phone button to call the desired selection.

# SYNC™

When you select:	You can:
	<b>Note:</b> The system attempts to automatically re-download your phonebook and call history each time your phone connects to SYNC (if the auto download feature is on and your Bluetooth-enabled cellular phone supports this feature).
Phonebook <sup>1,2</sup>	Access and call any contacts in your previously downloaded phonebook. 1. Press <b>OK</b> to confirm and enter. If your phonebook has fewer than 255 listings, they appear alphabetically in flat file mode. If there are more than 255 entries, the system organizes them into alphabetical categories. 2. Scroll until the desired contact appears, then press <b>OK</b> . 3. Press <b>OK</b> or the phone button.
Text Message <sup>1</sup>	Send, download and delete text messages.
Phone Settings <sup>1</sup>	View your phone's status, set ring tones, select your message notification, change phone book entries and automatically download your cellular phone among other features.
SYNC Services <sup>3</sup>	Access the SYNC Services portal where you can request various types of information, traffic reports and directions.
911 Assist <sup>4</sup>	Place an emergency call to a 911 operator for you after an accident, when used properly.
Vehicle Health Report <sup>3</sup>	Create and receive a diagnostic report card on your vehicle.
Mobile Apps <sup>3</sup>	Interact with SYNC-capable mobile applications on your smartphone.
System Settings	Access Bluetooth Devices menu listings (Add, Connect, Set as Primary, On and Off, Delete) as well as Advanced menu listings (prompts, languages, defaults, master reset, install application and system information).
Exit Phone Menu	Exit the phone menu by pressing OK.

<sup>1</sup> This is a phone-dependent feature.

<sup>2</sup> This is a phone-dependent and speed-dependent feature.

<sup>3</sup> This is an optional feature and available in the United States only.

<sup>4</sup> This is an optional feature and available in the United States and Canada only.

## Text Messaging

**Note:** *This is a phone-dependent feature.*

SYNC allows you to receive, send, download and delete text messages. The system can also read incoming text messages to you so that you do not have to take your eyes off the road.

### Receiving a Text Message

**Note:** *This is a phone-dependent feature. Your phone must support downloading text messages using Bluetooth to receive incoming text messages.*

When a new message arrives, an audible tone sounds and the display indicates you have a new message. You have these options:

- Press the voice button, wait for the prompt and say "Read message" to have SYNC read the message to you.
- Press **OK** to receive and open the text message or do nothing and the message goes into your text message inbox. Press **OK** again and SYNC reads your message aloud as you are not able to view the message. You can then also choose to reply or forward the message.
- Press **OK** and scroll to choose between:
  - **Reply to Text Message:** Press **OK** to access and then scroll through the list of pre-defined messages to send.
  - **Forward Text Message:** Press **OK** to forward the message to anyone in your Phonebook or Call History. You can also choose Enter Number.

## Sending, Downloading and Deleting Your Text Messages

**Note:** *Forwarding a text message is a speed-dependent feature and is only available when your vehicle is traveling at 3 mph (5 km/h) or less.*

**Note:** *You can only have one recipient per text message.*

Text messaging is a phone-dependent feature. If your phone is compatible, SYNC allows you to receive, send, download and delete text messages.

1. Press the phone button.
2. Scroll to Text Message, and then press **OK**.

Scroll to select from the following options:

- **Send Text Message?** allows you to send a new text message based on a pre-defined set of 15 messages.
- **Download Unread Msgs** allows you to download your unread messages (only) to SYNC. To download the messages, press **OK** to select. The display indicates that it is downloading your messages. When it is complete, SYNC takes you to your inbox.
- **Delete All Messages?** allows you to delete current text messages from SYNC (not your phone). To delete the messages, press **OK** to select. The display indicates when it is finished deleting all your text messages. SYNC returns you to the text message menu.
- **Return** exits the current menu when you press **OK**.

If you select **Send Text Message?**:

1. Press **OK** to select. If the system detects your phone does not support this feature, **Unsupported** appears in the display and SYNC returns to the main menu.
2. Scroll to cycle through the message options in the following chart.



3. Press **OK** when the desired selection is in the display.
4. Enter the name of the recipient. Scroll to cycle through Phonebook or Call History entries. You can also select Enter Number to say the desired number.
5. Press **OK** to enter the desired menu and scroll to select the specific contact.
6. Press **OK** when the contact appears and press **OK** again to confirm when the system asks if you would like to send the message. The system sends each text message with the following signature: "This message was sent from my <Ford or Lincoln>".

Pre-defined text message options
No
Why?
Thanks
Where R you?
I need more directions
I love you
Too funny
Can't wait to see you
I'm stuck in traffic

Pre-defined text message options
Can't talk right now
Call me
Call U later
Be there in 10 minutes
Be there in 20 minutes
Yes

## Accessing Your Phone Settings

These are phone-dependent features. Your phone settings allow you to access and adjust features such as your ring tone, text message notification, modify your phonebook and set up automatic download.

1. Press the phone button.
2. Scroll to Phone Settings, and then press **OK**.
3. Scroll to select from the following options:

When you select:	You can:
Phone Status	See the provider, name, signal power, battery power and roaming status of your connected phone. Press <b>OK</b> to select and scroll to view the information. When done, press <b>OK</b> again to return to the phone status menu.
Set Ringer	Select which ring tone sounds during an incoming call (one of the system's or your phone's). <ol style="list-style-type: none"> <li>1. Press <b>OK</b> to select and scroll to hear Ringer 1, Ringer 2, Ringer 3 and Phone Ringer.</li> <li>2. Press <b>OK</b> to select.</li> </ol>

When you select:	You can:
	If your phone supports in-band ringing, your phone's ring tone plays when you choose Phone Ringer.
Message Notification	Have the option of hearing an audible tone to notify you when a text message arrives. 1. Press <b>OK</b> to select and scroll between Message Notification On and Message Notification Off. 2. Press <b>OK</b> to select.
Modify Phonebook	<p>Modify the contents of your phonebook (such as add, delete or download). Press <b>OK</b> to choose between:</p> <p>Add Contacts: Press <b>OK</b> to add more contacts from your phone book. Push the desired contact(s) on your phone. See your phone's manual on how to push contacts.</p> <p>Delete Phonebook: Press <b>OK</b> to delete the current phone book and call history. When <b>Delete Phonebook</b> appears, press <b>OK</b> to confirm. SYNC takes you back to the Phone Settings menu.</p> <p>Download Phonebook: Press <b>OK</b> to select, then and press <b>OK</b> again when <b>Confirm Download?</b> appears.</p>
Auto Download	Automatically download your phone book each time your phone connects to SYNC.* Press <b>OK</b> to select. When <b>Auto Download On?</b> appears, press <b>OK</b> to have your phonebook automatically downloaded each time.** Select Off if you do not want to download your phonebook every time your phone connects to SYNC. Your phonebook, call history and text messages can only be accessed when your specific phone is connected to SYNC.
Return	Exit the current menu.

\*Downloading times are phone-dependent and quantity-dependent.

\*\*When Auto Download is on, it automatically deletes any changes, additions or deletions saved since your last download.

## System Settings

This menu provides access to your Bluetooth Devices and Advanced menu features. Use the arrow buttons to scroll through the menu options.

## Bluetooth Devices

The Bluetooth Devices menu allows you to add, connect and delete devices, set a phone as primary as well as turn your Bluetooth feature on and off.

# SYNC™

1. Press the phone button to enter the phone menu
2. Scroll to System Settings. Press **OK**.
3. Scroll to Bluetooth Devices. Press **OK**.
4. Scroll to select from the following options:

If you select:	You can:
Add Bluetooth Device*	See <b>Using SYNC™ With Your Phone</b> (page 263).
Connect Bluetooth Device	Connect a previously paired Bluetooth-enabled phone.** 1. Press <b>OK</b> to select and view a list of previously paired phones. 2. Scroll until you find the desired device, and then press <b>OK</b> to connect the phone.
Set as Primary Phone	Set a previously paired phone as your primary phone. Press <b>OK</b> to select and scroll to select the desired phone. Press <b>OK</b> to confirm. SYNC attempts to connect with the primary phone at every ignition cycle. When you select a phone as a primary phone, it appears first in the list and the system marks it with an asterisk.
Set Bluetooth	Turn the Bluetooth feature on and off. Press <b>OK</b> and scroll to toggle between On and Off. Make a selection, and then press <b>OK</b> . Setting Bluetooth to off disconnects all Bluetooth devices and turns off all Bluetooth features.
Delete Device	Delete a paired phone. Press <b>OK</b> and scroll to select the device. Press <b>OK</b> to confirm.
Delete All Devices	Delete all previously paired phones (and all information originally saved with those phones). Press <b>OK</b> to select.
Return	Exit the current menu.

\* This is a speed-dependent feature.

\*\*You can only connect one device at a time. When another phone is connected, the previous one is disconnected.

## Advanced

The Advanced menu allows you to access and set prompts, languages, defaults, perform a master reset, install an application and view system information.

1. Press the phone button to enter the phone menu
2. Scroll to System Settings. Press **OK**.
3. Scroll to Advanced. Press **OK**.
4. Scroll to select from the following options:

If you select:	You can:
Prompts	Get help from SYNC by using questions, helpful hints or asking you for a specific action. To turn these prompts on or off: 1. Press <b>OK</b> to select and scroll to select between On and Off. 2. Press <b>OK</b> when the desired selection appears in the display. SYNC takes you back to the Advanced menu.
Languages	Choose between English, Français and Español. Once selected, all of the radio displays and prompts are in the selected language. 1. Press <b>OK</b> to select and then scroll through the languages. 2. Press <b>OK</b> when the desired selection appears in the display. If you change the language setting, the display indicates that the system is updating. When complete, SYNC takes you back to the Advanced menu.
Factory Defaults	Return to the factory default settings. This selection does not erase your indexed information (phonebook, call history, text messages and paired devices). 1. Press <b>OK</b> to select and then press <b>OK</b> again when <b>Restore Defaults?</b> appears in the display. 2. Press <b>OK</b> to confirm.
Master Reset	Completely erase all information stored on SYNC (phonebook, call history, text messages and paired devices) and return to the factory default settings. Press <b>OK</b> to select. The display indicates when complete and SYNC takes you back to the Advanced menu.
Install Application?	Install applications you have downloaded. Press <b>OK</b> and scroll to select. Press <b>OK</b> to confirm.
Delete All Devices	Delete all previously paired phones (and all information originally saved with those phones). Press <b>OK</b> to select.
System Info	Access the Auto Version number as well as the FDN number.

If you select:	You can:
	Press <b>OK</b> to select.
MAP Profile	This is a Bluetooth component, which can further help your phone with the exchange of text messages.
Return	Exit the current menu.

## SYNC™ APPLICATIONS AND SERVICES

In order for the following features to work, your cellular phone must be compatible with SYNC. To check your phone's compatibility, visit [www.SYNCMyRide.com](http://www.SYNCMyRide.com), [www.SYNCMyRide.ca](http://www.SYNCMyRide.ca) or [www.syncmaroute.ca](http://www.syncmaroute.ca).

- SYNC Services\*: Provides access to traffic, directions and information such as travel, horoscopes, stock prices and more.
- 911 Assist: Can alert 911 in the event of an emergency.
- Vehicle Health Report\*: Provides a diagnostic and maintenance report card of your vehicle.

\*This is an optional feature and available in the United States only.

### 911 Assist

#### WARNINGS



Unless the 911 Assist setting is set on before a crash, the system will not dial for help which could delay response time, potentially increasing the risk of serious injury or death after a crash.

#### WARNINGS



Do not wait for 911 Assist to make an emergency call if you can do it yourself. Dial emergency services immediately to avoid delayed response time which could increase the risk of serious injury or death after a crash. If you do not hear 911 Assist within five seconds of the crash, the system or phone may be damaged or non-functional.



Always place your phone in a secure location in your vehicle so it does not become a projectile or get damaged in a crash. Failure to do so may cause serious injury to someone or damage the phone which could prevent 911 Assist from working properly.

**Note:** *The SYNC 911 Assist feature must be set on before the incident.*

**Note:** *Before setting this feature on, make sure that you read the 911 Assist Privacy Notice later in this section for important information.*

**Note:** *If any user turns 911 Assist on or off, that setting applies for all paired phones. If 911 Assist is turned off, either a voice message plays or a display message (or icon) comes on (or both) when your vehicle is started after a previously paired phone connects.*

**Note:** *Every phone operates differently. While SYNC 911 Assist works with most cellular phones, some may have trouble using this feature.*

If a crash deploys an airbag (excluding knee airbags and rear inflatable safety belts [if equipped]) or activates the fuel pump shut-off, your SYNC-equipped vehicle may be able to contact emergency services by dialing 911 through a paired and connected Bluetooth-enabled phone. You can learn more about the 911 Assist feature, visit [www.SYNCMyRide.com](http://www.SYNCMyRide.com), [www.SYNCMyRide.ca](http://www.SYNCMyRide.ca) or [www.syncmaroute.ca](http://www.syncmaroute.ca).

See **Supplementary Restraints System** (page 34). Important information about airbag deployment is in this chapter.

See **Roadside Emergencies** (page 166). Important information about the fuel pump shut-off is in this chapter.

## Setting 911 Assist On

1. Press the phone button to enter the phone menu.
2. Scroll to select 911 Assist.
3. Press **OK** to confirm and enter the 911 Assist menu.
4. Scroll to select between On and Off.
5. Press **OK** when the desired option appears in the radio display. **Set On** or **Set Off** appears in the display as confirmation.

Off selections include:

- Off with reminder: Provides a display and voice reminder at phone connection at vehicle start.
- Off without reminder: Provides a display reminder only without a voice reminder at phone connection.

To make sure that 911 Assist works properly:

- SYNC must be powered and working properly at the time of the incident and throughout feature activation and use.
- The 911 Assist feature must be set on before the incident.

- You must pair and connect a Bluetooth-enabled and compatible cell phone to SYNC.
- A connected Bluetooth-enabled phone must have the ability to make and maintain an outgoing call at the time of the incident.
- A connected Bluetooth-enabled phone must have adequate network coverage, battery power and signal strength.
- The vehicle must have battery power and be located in the U.S., Canada or in a territory in which 911 is the emergency number.

## In the Event of a Crash

Not all crashes will deploy an airbag or activate the fuel pump shut-off (the triggers for 911 Assist). If a connected cell phone sustains damage or loses its connection to SYNC during a crash, SYNC will search for and try to connect to a previously paired cell phone; SYNC will then attempt to call the emergency services.

Before making the call:

- SYNC provides a short window of time (about 10 seconds) to cancel the call. If you fail to cancel the call, SYNC attempts to dial 911.
- SYNC says the following, or a similar message: "SYNC will attempt to call 911, to cancel the call, press Cancel on your screen or press and hold the phone button on your steering wheel."

If you do not cancel the call, and SYNC makes a successful call, a pre-recorded message plays for the 911 operator, and then the occupant(s) in your vehicle is able to talk with the operator. Be prepared to provide your name, phone number and location immediately, because not all 911 systems are capable of receiving this information electronically.

## 911 Assist May Not Work If

- Your cellular phone or 911 Assist hardware sustains damage in a crash.
- The vehicle's battery or the SYNC system has no power.
- The phone(s) thrown from your vehicle are the ones paired and connected to the system.

## 911 Assist Privacy Notice

When you turn on 911 Assist, it may disclose to emergency services that your vehicle has been in a crash involving the deployment of an airbag or activation of the fuel pump shut-off. Certain versions or updates to 911 Assist may also be capable of electronically or verbally disclosing to 911 operators your vehicle location or other details about your vehicle or crash to assist 911 operators to provide the most appropriate emergency services. If you do not want to disclose this information, do not turn the feature on.

## Vehicle Health Report

### WARNING



Always follow scheduled maintenance instructions, regularly inspect your vehicle, and seek repair for any damage or problem you suspect. Vehicle Health Report supplements, but cannot replace, normal maintenance and vehicle inspection. Vehicle Health Report only monitors certain systems electronically monitored by your vehicle and will not monitor or report the status of any other system, (such as brake lining wear). Failure to perform scheduled maintenance and regularly inspect your vehicle may result in vehicle damage and serious injury.

**Note:** This feature is only available in the United States.

**Note:** Your Vehicle Health Report feature requires activation before use. Visit [www.SYNCMYride.com](http://www.SYNCMYride.com) to register. There is no fee or subscription associated with Vehicle Health Report, but you must register to use this feature.

**Note:** This feature may not function properly if you have enabled caller ID blocking on your cellular phone. Before running a report, review the Vehicle Health Report Privacy Notice.

**Note:** In order to allow a break-in period for your vehicle, you may not be able to create a Vehicle Health Report until your vehicle odometer has reached 200 miles.

**Note:** Cellular phone and SMS charges may apply when making a report.

Register for Vehicle Health Report and set your report preferences at [www.SYNCMYride.com](http://www.SYNCMYride.com). After registering, you can request a Vehicle Health Report (inside your vehicle). Return to your account at [www.SYNCMYride.com](http://www.SYNCMYride.com) to view your report. You can also choose for SYNC to remind you automatically to run reports at specific mileage intervals.

The system allows you to check your vehicle's overall health in the form of a diagnostic report card. The vehicle health report contains valuable information such as:

- Vehicle diagnostic information
- Scheduled maintenance
- Open recalls and Field Service Actions
- Items noted during vehicle inspections by an authorized dealer that still need servicing.

You can run a report (after your vehicle has been running a minimum of 60 seconds) by pressing the voice button and saying "Vehicle health report", or pressing the phone button.

To run a report using the phone button:

1. Press the phone button to enter phone menu.
2. Scroll to select Vehicle Health, and then press **OK**.
3. Scroll to select from the following options:

Vehicle health report options	
User Preferences: Press <b>OK</b> to select and enter the menu. Scroll to select from:	<b>Automatic Reports:</b> Press <b>OK</b> to and select On or Off. Select On to have SYNC automatically prompt you to run a health report at certain mileage intervals.*
	<b>Mileage Intervals:</b> Press <b>OK</b> . Scroll to select between 5000, 7500 or 10000-mile intervals and press <b>OK</b> to make your selection.
	<b>Return:</b> Press OK to exit the menu.
Run Report?	Press <b>OK</b> for SYNC to run a health report of your vehicle's diagnostic systems and send the results to Ford where it combines with scheduled maintenance information, open recalls and other field service actions and vehicle inspection items that still need servicing from an authorized dealer.

\*You must first turn this feature on before you can select the desired mileage interval.

## Vehicle Health Report Privacy Notice

When you create a Vehicle Health Report, Ford Motor Company may collect your cellular phone number (to process your report request) and diagnostic information about your vehicle. Certain versions or updates to Vehicle Health Report may also collect more vehicle information. Ford may use your vehicle information it collects for any purpose. If you do not want to disclose your cellular phone number or vehicle information, do not run the feature or set up your Vehicle Health Report profile at [www.SYNCMyRide.com](http://www.SYNCMyRide.com). See [www.SYNCMyRide.com](http://www.SYNCMyRide.com) (Vehicle Health Report Terms and Conditions, and Privacy Statement) for more information.

## SYNC Services: Traffic, Directions & Information (TDI)

**Note:** SYNC Services requires activation before use. Visit [www.SYNCMyRide.com](http://www.SYNCMyRide.com) to register and check your eligibility for complimentary services. Standard phone and message rates may apply. Subscription may be required. You must also have the active SYNC Services Bluetooth-enabled cellular phone paired and connected to the system in order to connect to, and use, SYNC Services. See **Using SYNC™ With Your Phone** (page 263).

**Note:** This feature does not function properly if you have enabled caller ID blocking on your cellular phone. Make sure your cellular phone is not blocking caller ID before using SYNC Services.



**Note:** *The driver is ultimately responsible for the safe operation of the vehicle, and therefore, must evaluate whether it is safe to follow the suggested directions. Any navigation features provided are only an aid. Make your driving decisions based on your observations of local conditions and existing traffic regulations. Do not follow the route suggestions if doing so would result in an unsafe or illegal maneuver, place you in an unsafe situation, or if you would be directed into an area that you consider unsafe. Maps used by this system may be inaccurate because of errors, changes in roads, traffic conditions or driving conditions.*

**Note:** *When you connect, the service uses GPS technology and advanced vehicle sensors to collect your vehicle's current location, travel direction and speed to help provide you with the directions, traffic reports, or business searches you request. Further, to provide the services you request, for continuous improvement, the service may collect and record call details and voice communications. For more information, see SYNC Services Terms and Conditions at [www.SYNCMyRide.com](http://www.SYNCMyRide.com). If you do not want Ford or its service providers to collect your vehicle travel information or other information identified in the Terms and Conditions, do not subscribe or use the service.*

SYNC Services uses advanced vehicle sensors, integrated GPS technology and comprehensive map and traffic data, to give you personalized traffic reports, precise turn-by-turn directions, business search, news, sports, weather and more. For a complete list of services, or to learn more, please visit [www.SYNCMyRide.com](http://www.SYNCMyRide.com).

### **Connecting to SYNC Services Using Voice Commands**

1. Press the voice button.

2. When prompted, say "Services". This initiates an outgoing call to SYNC Services using your paired and connected Bluetooth-enabled cellular phone.
3. Once you connect to the service, follow the voice prompts to request the desired service, such as Traffic or Directions. You can also say, "What are my choices?" to receive a list of available services from which to choose.
4. Say, "Services" to return to the Services main menu or for help, say, "Help".

### **Connecting to SYNC Services Using the Phone Menu**

1. Press the phone button to enter the phone menu.
2. Scroll to Services.
3. Press **OK** to confirm and enter the Services menu. The display indicates the system is connecting.
4. Press **OK**. SYNC initiates the call to the Services portal.
5. Once you connect to the service, follow the voice prompts to request the desired service, such as Traffic or Directions. You can also say, "What are my choices?" to receive a list of available services from which to choose.
6. Say, "Services" to return to the Services main menu or for help, say, "Help".

### **Receiving Turn-by-Turn Directions**

1. When connected to SYNC Services, say "Directions" or "Business search". To find the closest business or type of business to your current location, just say "Business search" and then "Search near me". If you need further assistance in finding a location you can say "Operator" at any time within a

Directions or Business search to speak with a live operator. The system may prompt you to speak with an operator when it has difficulty matching your voice request. The live operator can assist you by searching for businesses by name or by category, residential addresses by street address or by name or specific street intersections. Operator Assist is a feature of your SYNC Services subscription. For more information on Operator Assist, visit [www.SYNCMyRide.com/support](http://www.SYNCMyRide.com/support).

2. Follow the voice prompts to select your destination. Once you select your destination, the system uploads your current vehicle location, calculates a route based on current traffic conditions and sends it back to your vehicle. After the route download is complete, the phone call automatically ends. You then receive audible and visual driving instructions as you travel toward your destination.

3. While on an active route, you can select or say "Route summary" or "Route status" to view the Route Summary turn list or the Route Status ETA. You can also turn voice guidance on or off, cancel the route or update the route.

If you miss a turn, SYNC automatically asks if you want the route updated. Just say, "Yes" when prompted and the system sends a new route to your vehicle.

### Disconnecting from SYNC Services

1. Press and hold the phone button on the steering wheel.
2. Say "Goodbye" from the SYNC Services main menu.

<b>SYNC Services quick tips</b>	
Personalizing	You can personalize your Services feature to provide quicker access to your most used or favorite information. You can save address points such as work or home. You can also save favorite information like sports teams or a news category. You can learn more about personalization by logging onto <a href="http://www.SYNCMyRide.com">www.SYNCMyRide.com</a> .
Push to interrupt	Press the voice button at any time (while connected to SYNC Services) to interrupt a voice prompt or an audio clip (such as a sports report) and say your voice command.
Portable	Your subscription is associated with your Bluetooth-enabled cellular phone number, not your VIN (Vehicle Identification Number). You can pair and connect your phone to any vehicle equipped with SYNC Services and continue enjoying your personalized services. You can even access your account outside your vehicle. Just use the number on your phone's call history. Traffic and Directions features do not function properly but information services and the 411 connect and text message features are available.

## SYNC AppLink

**Note:** This feature is only available in the United States.

**Note:** You must pair and connect your smartphone to SYNC to access AppLink.

**Note:** iPhone users need to connect the phone to the USB port in order to start the application. We recommend you lock your iPhone after starting an application.

**Note:** The AppLink feature is not available if your vehicle is equipped with the MyFord Touch or MyLincoln Touch system.

**Note:** Depending on your display type, you can access AppLink from the media menu, the phone menu, or by using voice commands. Once an app is running through AppLink, you can control main features of the app through voice commands and steering wheel controls.

### To Access Using the Phone Menu

1. Press the phone button to access the SYNC phone menu on-screen.
2. Scroll to Mobile Apps and press OK to access a list of available applications.
3. Scroll through the list of available applications and press OK to select a particular app.
4. Once an app is running through SYNC, you can access an app's menu by pressing the **MENU** button to first access the SYNC menu.
5. Select "SYNC-Media" by pressing **OK**.
6. Scroll until "<App name> Menu" is displayed (such as, Pandora Menu), then press **OK**. From here, you can access an application's features, such as Thumbs up and Thumbs down. For more information, please visit [www.SYNCMyRide.com](http://www.SYNCMyRide.com).

### To Access Using the Media Menu

1. Press the **AUX** button on the center console.
2. Press **MENU** to access the SYNC menu.
3. Select "SYNC-Media" by pressing **OK**.
4. Scroll to Mobile Apps and press **OK** to access a list of available applications.
5. Scroll through the list of available applications and press **OK** to select a particular app.
6. Once an app is running through SYNC, you can access an app's menu by pressing the **MENU** button to first access the SYNC menu.
7. Select "SYNC-Media" by pressing **OK**.
8. Scroll until "<App name> Menu" is displayed (such as, Pandora Menu), then press **OK**. From here, you can access an application's features, such as Thumbs up and Thumbs down. For more information, please visit [www.SYNCMyRide.com](http://www.SYNCMyRide.com).

### To Access Using Voice Commands

1. Press the voice icon.
2. When prompted, say "Mobile Apps".
3. Say the name of the application after the tone.
4. The app should start. While an app is running through SYNC, you can press the voice button and speak commands specific to the app, such as "Play Station Quickmix". Say "Help" to discover available voice commands.

## USING SYNC™ WITH YOUR MEDIA PLAYER

You can access and play music from your digital music player over your vehicle's speaker system using the system's media menu or voice commands. You can also sort and play your music by specific categories, such as artist and album.

SYNC is capable of hosting nearly any digital media player including: iPod®, Zune™, Plays from device players, and most USB drives. SYNC also supports audio formats, such as MP3, WMA, WAV and ACC.

### Connecting Your Digital Media Player to the USB Port

**Note:** *If your digital media player has a power switch, make sure you switch it on before plugging it in.*

#### To Connect Using Voice Commands

1. Plug the device into the USB port.
2. Press the voice icon and when prompted, say "USB".
3. You can now play music by saying any of the appropriate voice commands. See the media voice commands.

#### To Connect Using the System Menu

1. Plug the device into the USB port.
2. Press **AUX** and then **MENU** to enter the media menu.
3. Scroll to Select Source. Press **OK**.
4. Scroll to USB. Press **OK**.
5. Depending on how many digital media files are on your connected device, **Indexing** may appear in the radio display. When indexing is complete, the screen returns to the Play menu.

Press **OK** and scroll through selections of:

- Play All
- Albums
- Genres
- Playlists
- Tracks
- Explore USB
- Similar Music
- Return

### What's Playing?

At any time when a track is playing, you can press the voice icon and ask the system "What's playing?". The system reads the metadata tags (if populated) of the playing track to you.

### Media Voice Commands



Press the voice icon. When prompted, say "USB", then any of the following:

<b>"USB"</b>
"Autoplay off"
"Autoplay on"
"Connections"
"Pause"
"Play"
"Play album <name>" <sup>1,2</sup>
"Play all"
"Play artist <name>" <sup>1,2</sup>
"Play genre <name>" <sup>1,2</sup>
"Play next folder" <sup>1,3</sup>
"Play next track"

"USB"
"Play playlist <name>" <sup>1,2</sup>
"Play previous folder" <sup>3</sup>
"Play previous track"
"Play song <name>" <sup>1,2</sup>
"Play track <name>" <sup>1,2</sup>
"Refine album <name>" <sup>1,2</sup>
"Refine artist <name>" <sup>1,2</sup>
"Refine song <name>" <sup>1,2</sup>
"Refine track <name>" <sup>1,2</sup>
"Repeat off"
"Repeat on"
"Search album <name>" <sup>1,2</sup>

"USB"
"Search artist <name>" <sup>1,2</sup>
"Search genre <name>" <sup>1,2</sup>
"Search song <name>" <sup>1,2</sup>
"Search track <name>" <sup>1,2</sup>
"Shuffle off"
"Shuffle on"
"Similar music"
"What's playing?"

<sup>1</sup> <name> is a dynamic listing, meaning that it could be the name of anything, such as a group, artist or song.

<sup>2</sup> This voice command is not available until indexing is complete.

<sup>3</sup> This voice command is only available in folder mode.

Voice command guide	
"Autoplay"	Turn autoplay on to listen to music processed during indexing. Turn autoplay off to allow the indexing process to finish before the system plays any of your music.*
"Search genre" or "Play genre"	The system searches all the data from your indexed music and, if available, begins to play the chosen type of music. You can only play genres of music that are present in the GENRE metadata tags that you have on your digital media player.
"Similar music"	The system compiles a playlist and then plays music similar to what is currently playing from the USB port using indexed metadata information.

Voice command guide	
"Search" or "Play" artist, track or album	The system searches for specific artist, track or album information from the music indexed through the USB port.
"Refine"	This allows you to make your previous command more specific. For example, if you asked to search and play all music by a certain artist, you could then say, "Refine album" and choose a specific album from the list to view. If you then select Play, the system only plays music from that specific album.

\*Indexing times can vary from device to device and with regard to the number of songs the system needs to process.

Press the voice icon. When prompted, say, "Bluetooth audio", then any of the following:

"BLUETOOTH AUDIO"
"Connections"
"Pause"
"Play"
"Play next track"
"Play previous track"

## Media Menu Features

The media menu allows you to select your media source, how to play your music (such as by artist, genre, shuffle or repeat), and also to add, connect or delete devices.

1. Press **AUX** and then **MENU** to enter the media menu.
2. Scroll to cycle through:

When you select:	You can:
Play Menu	Play your music by artist, album, genre, playlist, track, similar music or play all music. You can also choose to Explore USB to view the supported digital music files on your playing device.
Select Source	Select and play music from your USB port, auxiliary input jack (line in) or stream music from your Bluetooth-enabled phone.  SYNC USB: Press <b>OK</b> to access music plugged into your USB port. You can also plug in devices to charge them (if supported by your device). Once connected, the system indexes any readable media files. <sup>1</sup>

# SYNC™

When you select:	You can:
	<p>Bluetooth Audio: This is a phone-dependent feature that allows you to stream music playing on your Bluetooth-enabled phone. If supported by your device, you can press <b>SEEK</b> to play the previous or next track.</p> <p>SYNC Line In: Press <b>OK</b> to select and play music from your portable music player over your vehicle's speakers.<sup>2</sup></p>
Media Settings	<p>Choose to shuffle or repeat your music and select your Autoplay settings. Once you turn these selections on, they remain on you turn them off. Press <b>SEEK</b> to play the previous or next track.<sup>3</sup></p> <p>Shuffle: Press <b>OK</b> to shuffle available media files in the current playlist. To shuffle all media tracks, you must select Play All in the play menu and then select Shuffle.</p> <p>Repeat: Press <b>OK</b> to repeat any song.</p> <p>Autoplay: Turn autoplay on to listen to music processed during indexing. Turn autoplay off to allow the indexing process to finish before the system plays any of your music.<sup>4</sup></p>
Mobile Apps	Interact with SYNC-capable mobile applications on your smartphone.

When you select:	You can:
System Settings	Access Bluetooth Device menu listings (Add, Connect, Set as Primary, On and Off, Delete) as well as Advanced menu listings (prompts, languages, defaults, master reset, install application and system information).
Exit Media Menu	Press <b>OK</b> to exit the media menu.

<sup>1</sup>The time required to complete this depends on the size of the media the system needs to index. If autoplay is on, you can listen to media processed during indexing. If autoplay is off, you cannot listen to music until the system finishes indexing media. SYNC is capable of indexing thousands of average size media and notifies you if it reaches the maximum indexing file size.

<sup>2</sup>If you have already connected a device to the USB port, you cannot access the line in feature. Some digital media players require both USB and line in ports to stream data and music separately.

<sup>3</sup>Some digital media players require both USB and line in ports to stream data and music separately

<sup>4</sup>Indexing times can vary from device to device and with regard to the number of songs the system needs to process.

## Accessing Your Play Menu

This menu allows you to select and play your media by artist, album, genre, playlist, track, similar music or even to explore what is on your USB device.

**Note:** *If your digital media player has a power switch, make sure you switch it on before plugging it in.*

1. Press **AUX** and then **MENU** to enter the media menu.
2. Scroll to Play. Press **OK**.

If there are no media files to access, the display indicates there is no media. If there are media files, you have the following options:

When you select:	You can:
Play All	Play all indexed media (tracks) from your playing device in flat file mode, one at a time in numerical order. Press <b>OK</b> to select. The first track title appears in the display.
Artists	Sort all indexed media by artist. Once selected, the system lists and then play all artists and tracks alphabetically. If there are fewer than 255 indexed artists, the system lists them alphabetically in flat file mode. If there are more than 255, the system categorizes them alphabetically.



# SYNC™

When you select:	You can:
	1. Press <b>OK</b> to select. You can select to play All Artists or any indexed artist. 2. Scroll to choose the desired artist. Press <b>OK</b> .
Albums	Sort all indexed media by albums. If there are fewer than 255 indexed albums, the system lists them alphabetically in flat file mode. If there are more than 255, the system categorizes them alphabetically. 1. Press <b>OK</b> to enter the album menu and select from playing all albums or from any individual indexed album. 2. Scroll to choose the desired album. Press <b>OK</b> .
Genres	Sort indexed music by genre (category) type. SYNC lists the genres alphabetically in flat file mode. If there are more than 255, the system categorizes them alphabetically. 1. Press <b>OK</b> to select. 2. Scroll to select the desired genre. Press <b>OK</b> .
Playlists	Access your playlists (from formats, such as .ASX, .M3U, .WPL or .MTP). The system lists your playlists alphabetically in flat-file mode. If there are more than 255, the system categorizes them alphabetically. 1. Press <b>OK</b> to select. 2. Scroll to select the desired playlist. Press <b>OK</b> .
Tracks	Search for and play a specific indexed track. SYNC lists your tracks alphabetically in flat file mode. If there are more than 255, the system categorizes them alphabetically. 1. Press <b>OK</b> to select. 2. Scroll to select the desired track. Press <b>OK</b> .
Explore USB	Explore all supported digital media on your media device connected to the USB port. You can only view media content which is compatible with SYNC; other files saved are not visible. 1. Press <b>OK</b> to select. 2. Scroll to explore indexed media on your flash drive.
Similar Music*	Play music similar to what is currently playing from the USB port. The system uses the metadata information of each song to compile a playlist for you.

When you select:	You can:
	Press <b>OK</b> to select. The system creates a new list of similar songs and begins playing. This feature does not include tracks with incomplete metadata information.
Return	Exit the current menu.

\*With certain playing devices, if your metadata tags are not populated, the tracks are not available in voice recognition, play menu or similar music. However, if you place these tracks onto your playing device in "Mass Storage Device Mode", they are available in voice recognition, play menu browsing and similar music. The system places Unknown items into any unpopulated metadata tag.

## System Settings

### Bluetooth Devices

The Bluetooth Devices menu allows you to add, connect and delete a device as turn the Bluetooth feature on and off.

1. Press **AUX** and then **MENU** to enter the media menu.
2. Scroll to System Settings. Press **OK**.
3. Scroll to Bluetooth Devices. Press **OK**.

When you select:	You can:
Add Bluetooth Device*	Pair more devices to the system. 1. Press <b>OK</b> to select and press <b>OK</b> again when <b>Find SYNC</b> appears in the display. 2. Follow the directions in your phone's manual to put your phone into discovery mode. A six-digit PIN appears in the display. 3. When prompted on your phone's six-digit display, enter the PIN.
Connect Bluetooth Device	Connect a previously paired Bluetooth-enabled device. 1. Press <b>OK</b> to select and view a list of previously paired devices. 2. Scroll until you find the desired device, and then press <b>OK</b> to connect the device.
Set Bluetooth	Turn the Bluetooth feature on and off.** 1. Press <b>OK</b> and scroll to toggle between On and Off. 2. Make a selection, and then press <b>OK</b> .
Delete Device	Delete a paired media device. 1. Press <b>OK</b> and scroll to select the device. 2. Press <b>OK</b> to confirm.
Delete All Devices	Delete all previously paired devices.

# SYNC™

When you select:	You can:
	Press <b>OK</b> to select.
Return	Exit the current menu.

\*This is a speed-dependent feature.

\*\*Setting Bluetooth to off disconnects all Bluetooth devices and turns off all Bluetooth features.

## Advanced

The Advanced menu allows you to access and set prompts, languages, defaults and perform a master reset.

1. Press **AUX** and then **MENU** to enter the media menu.
2. Scroll to System Settings. Press **OK**.
3. Scroll to Advanced. Press **OK**.

When you select:	You can:
Prompts	Have SYNC guide you by asking questions, helpful hints or ask you for a specific action. 1. Press <b>OK</b> to select and scroll to select between on or off. 2. Press <b>OK</b> when the desired selection appears in the display. SYNC takes you back to the Advanced menu.
Languages	Choose from English, Français or Español. The displays and prompts are in the selected language. 1. Press <b>OK</b> to select and then scroll through the languages. 2. Press <b>OK</b> when the desired selection appears in the display. 3. If you change the language setting, the display indicates that the system is updating. When complete, SYNC takes you back to the Advanced menu.
Factory Defaults	Return to the factory default settings. This selection does not erase your indexed information (phonebook, call history, text messages and paired devices). 1. Press <b>OK</b> to select. 2. Press <b>OK</b> again when <b>Restore Defaults?</b> appears in the display. 3. Press <b>OK</b> to confirm.

# SYNC™

When you select:	You can:
Master Reset	Completely erase all information stored on SYNC (all phonebook, call history, text messages and all paired devices) and return to the factory default settings.
Application	Download new software applications (if available) and then load the desired applications through your USB port. See the web site for more information.
Return	Exit the current menu.

## SYNC™ TROUBLESHOOTING

Your SYNC system is easy to use. However, should questions arise, see the tables below.

Use the website at any time to check your phone's compatibility, register your account and set preferences as well as access a customer representative via an online chat (during certain hours). Visit [www.SYNCMYride.com](http://www.SYNCMYride.com), [www.SYNCMYride.ca](http://www.SYNCMYride.ca) or [www.syncmaroute.ca](http://www.syncmaroute.ca) for more information.

Phone issues		
Issue	Possible cause(s)	Possible solution(s)
There is excessive background noise during a phone call.	The audio control settings on your phone may be affecting SYNC performance.	Review your phone's manual about audio adjustments.
During a call, I can hear the other person but they cannot hear me.	This may be a possible phone malfunction.	Try turning off the device, resetting the device, removing the device's battery, then trying again.
SYNC is not able to download my phonebook.	<ul style="list-style-type: none"> <li>· This is a phone-dependent feature.</li> <li>· This may be a possible phone malfunction.</li> </ul>	<ul style="list-style-type: none"> <li>· Go to the website to review your phone's compatibility.</li> <li>· Try turning off the device, resetting the device or removing the device's battery, then trying again.</li> <li>· Try pushing your phonebook contacts to SYNC by using the Add Contacts feature.</li> <li>· Use the SYNCmyphone feature available on the website.</li> </ul>

# SYNC™

<b>Phone issues</b>		
<b>Issue</b>	<b>Possible cause(s)</b>	<b>Possible solution(s)</b>
The system says Phonebook Downloaded but the phonebook in SYNC is empty or missing contacts.	This may be a limitation on your phone's capability.	<ul style="list-style-type: none"> <li>· Try pushing your phonebook contacts to SYNC by using the Add Contacts feature.</li> <li>· If the missing contacts are stored on your SIM card, try moving them to the device memory.</li> <li>· Remove any pictures or special ring tones associated with the missing contact.</li> </ul>
I am having trouble connecting my phone to SYNC.	<ul style="list-style-type: none"> <li>· This is a phone-dependent feature.</li> <li>· This may be a possible phone malfunction.</li> </ul>	<ul style="list-style-type: none"> <li>· Go to the website to review your phone's compatibility.</li> <li>· Try turning off the device, resetting the device or removing the device's battery, then trying again.</li> <li>· Try deleting your device from SYNC, deleting SYNC from your device and trying again.</li> <li>· Check the security and auto accept and prompt always settings relative to the SYNC Bluetooth connection on your phone.</li> <li>· Update your device's firmware.</li> <li>· Turn off the Auto phonebook download setting.</li> </ul>
Text messaging is not working on SYNC.	<ul style="list-style-type: none"> <li>· This is a phone-dependent feature.</li> <li>· This may be a possible phone malfunction.</li> </ul>	<ul style="list-style-type: none"> <li>· Go to the website to review your phone's compatibility.</li> <li>· Try turning off the device, resetting the device or removing the device's battery, then trying again.</li> </ul>

<b>USB and media issues</b>		
<b>Issue</b>	<b>Possible cause(s)</b>	<b>Possible solution(s)</b>
I am having trouble connecting my device.	This may be a possible device malfunction.	<ul style="list-style-type: none"> <li>· Try turning off the device, resetting the device, removing the device's battery, then trying again.</li> <li>· Make sure you are using the manufacturer's cable.</li> <li>· Make sure you insert the USB cable properly into the device and the USB port.</li> <li>· Make sure that the device does not have an auto-install program or active security settings.</li> </ul>
SYNC does not recognize my device when I turn on the car.	This is a device limitation.	Make sure you are not leaving the device in your vehicle during very hot or cold temperatures.
Bluetooth audio does not stream.	<ul style="list-style-type: none"> <li>· This is a phone-dependent feature.</li> <li>· The device is not connected.</li> </ul>	Make sure you properly connect the device to SYNC and that you have pressed play on your device.
SYNC does not recognize music that is on my device.	<ul style="list-style-type: none"> <li>· Your music files may not contain the proper artist, song title, album or genre information.</li> <li>· The file may be corrupted.</li> <li>· The song may have copy-right protection, which does not allow it to play.</li> </ul>	<ul style="list-style-type: none"> <li>· Make sure that all song details are populated.</li> <li>· Some devices require you to change the USB settings from mass storage to MTP class.</li> </ul>

<b>Vehicle Health Report and Services (Traffic, Directions and Information) issues</b>		
<b>Issue</b>	<b>Possible cause(s)</b>	<b>Possible solution(s)</b>
I received a text that I did not activate Vehicle Health Report.	<ul style="list-style-type: none"> <li>· You did not activate your account on the website.</li> <li>· You may have the wrong VIN (vehicle identification number) listed.</li> </ul>	<ul style="list-style-type: none"> <li>· This is a free feature, but you must first register online to use it.</li> </ul>

<b>Vehicle Health Report and Services (Traffic, Directions and Information) issues</b>		
<b>Issue</b>	<b>Possible cause(s)</b>	<b>Possible solution(s)</b>
		<ul style="list-style-type: none"> <li>· Make sure that your VIN is correctly listed in your account.</li> </ul>
I am unable to retrieve the report on the website, or I receive a system error.	The preferred dealer information did not load correctly.	When you register your account, you must choose a preferred dealer. If it already lists a dealer, try selecting another dealer and logging out. Log back in, change it back to your preferred dealer, and retrieve the report.
I am unable to submit a report.	<ul style="list-style-type: none"> <li>· This could be due to your phone's compatibility.</li> <li>· Bad signal strength.</li> <li>· You did not activate your phone on the website.</li> </ul>	<ul style="list-style-type: none"> <li>· Update your cellular number in your account on the website.</li> <li>· Make sure you have full signal strength and that your Bluetooth volume level has been turned up.</li> <li>· Try deleting your phone and performing a clean pairing.</li> </ul>
I heard a commercial when I tried to use Traffic, Directions and Information.	<ul style="list-style-type: none"> <li>· You did not activate this phone for this service.</li> <li>· Your phone has ID blocker active.</li> </ul>	<ul style="list-style-type: none"> <li>· This is a free feature, but you must first register online to use it.</li> <li>· Turn off ID blocker on your phone as the system recognizes you by your phone number.</li> <li>· Make sure the currently connected phone is the same one that is registered on your SYNCMyRide account.</li> </ul>

# SYNC™

<b>Voice command issues</b>		
<b>Issue</b>	<b>Possible cause(s)</b>	<b>Possible solution(s)</b>
SYNC does not understand what I am saying.	<ul style="list-style-type: none"> <li>· You may be using the wrong voice commands.</li> <li>· You may be speaking too soon or at the wrong time.</li> </ul>	<ul style="list-style-type: none"> <li>· Review the phone voice commands and the media voice commands at the beginning of their respective sections.</li> <li>· Be aware that SYNC's microphone is either in your rear view mirror or in the headliner just above the windshield.</li> </ul>
SYNC does not understand the name of a song or artist.	<ul style="list-style-type: none"> <li>· You may be using the wrong voice commands.</li> <li>· You may be saying the name differently than the way you saved it.</li> <li>· The system may not be reading the name the same way you are saying it.</li> </ul>	<ul style="list-style-type: none"> <li>· Review the media voice commands at the beginning of the media section.</li> <li>· Say the song or artist exactly as listed. If you say "Play Artist Prince", the system does not play music by Prince and the Revolution or Prince and the New Power Generation.</li> <li>· Make sure you are saying the complete title, such as "California remix featuring Jennifer Nettles".</li> <li>· If the song titles are in all CAPS, you have to spell them. LOLA requires you to say "L-O-L-A".</li> <li>· Do not use special characters in the title. The system does not recognize them.</li> </ul>
SYNC does not understand or is calling the wrong contact when I want to make a call.	<ul style="list-style-type: none"> <li>· You may be using the wrong voice commands.</li> <li>· You may be saying the name differently than the way you saved it.</li> <li>· Contacts in your phone-book may be very short and similar, or they may contain special characters.</li> </ul>	<ul style="list-style-type: none"> <li>· Review the Phone voice commands at the beginning of the phone section.</li> <li>· Make sure you are saying the contacts exactly as they are listed. For example, if you save a contact as Joe Wilson, say "Call Joe Wilson".</li> </ul>



# SYNC™

<b>Voice command issues</b>		
<b>Issue</b>	<b>Possible cause(s)</b>	<b>Possible solution(s)</b>
	<ul style="list-style-type: none"><li>· Your phonebook contacts may be in CAPS.</li></ul>	<ul style="list-style-type: none"><li>· The system works better if you list full names, such as "Joe Wilson" rather than "Joe".</li><li>· Do not use special characters, such as 123 or ICE, as the system does not recognize them.</li><li>· If a contact is in CAPS, you have to spell it. JAKE requires you to say "Call J-A-K-E".</li></ul>

## GENERAL INFORMATION

### WARNING



Driving while distracted can result in loss of vehicle control, crash and injury. We strongly recommend that you use extreme caution when using any device that may take your focus off the road. Your primary responsibility is the safe operation of your vehicle. We recommend against the use of any handheld device while driving and encourage the use of voice-operated systems when possible. Make sure you are aware of all applicable local laws that may affect the use of electronic devices while driving

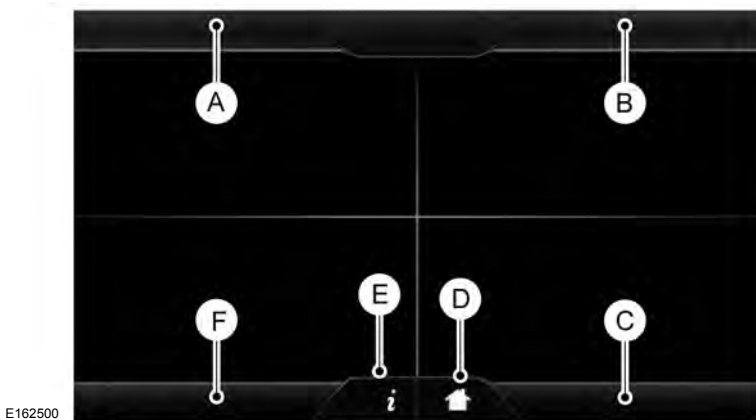

- A Phone
- B Navigation
- C Settings
- D Home icon
- E Information icon
- F Entertainment

# MyFord Touch™ (If Equipped)

This system uses a four-corner strategy to provide quick access to several vehicle features and settings. The touchscreen provides easy interaction with your cell phone, entertainment, information and system settings. The corners display active modes within the menus, for example; your cell phone's status.

**Note:** Some features are not available while your vehicle is moving.

**Note:** You can access the Home or Information menus by pressing the relevant button on the steering wheel controls.

**Note:** You can access the entertainment features for 30 minutes after you switch the ignition off, and no doors are opened.

## PHONE

Press to select any of the following:

- Phone
- Quick Dial
- Phonebook
- History
- Messaging
- Settings

## NAVIGATION

Press to select any of the following:

- My Home
- Favorites
- Previous Destinations
- Point of Interest
- Emergency
- Street Address
- Intersection
- City Center
- Map
- Edit Route Cancel Route



## SETTINGS

Press to select any of the following:

- Clock
- Display
- Sound
- Vehicle
- Settings
- Help



## HOME

Press to access the home screen.

**Note:** Depending on your vehicle's option package and software, the screens may vary in appearance from the descriptions in this section. The features may also be limited depending on the market. Check with an authorized dealer for availability.



## INFORMATION

Press to select any of the following:

- Services
- Travel Link
- Alerts
- Calendar
- Apps

## ENTERTAINMENT

Press to select any of the following:

- AM
- FM
- SIRIUS
- CD
- USB
- BT Stereo
- SD Card
- Line In

## Using the Touch-Sensitive Controls

To turn a feature on or off using the touch-sensitive controls:

- Make sure your hands are clean and dry.
- Press firmly on the center of a control graphic or menu item.
- Keep metal objects or other conductive material away from the surface of the touchscreen.

Depending on your vehicle's option package and software, it may also have the following controls:

- **Power:** Switch the media features on or off.
- **VOL:** Adjust the volume of playing media.
- **Seek:** Use as you normally would in media modes.
- **Tune:** Use as you normally would in media modes.
- **Eject:** Eject a CD from the entertainment system.
- **SOURCE:** Touch the control repeatedly to switch between media modes.
- **SOUND:** Adjust the settings for:
  - Bass
  - Treble
  - Midrange
  - Balance
  - Fade
  - DSP (Digital Signal Processing)
  - Occupancy Mode
  - Speed Compensated Volume.
- **Hazard warning flasher:** Switch the hazard warning flashers on or off.

## Cleaning the Touchscreen Display

Use a dry, clean, soft cloth. If dirt or fingerprints are still visible, apply a small amount of alcohol to the cloth. Do not pour or spray alcohol onto the display. Do not use detergent or any type of solvent to clean the display.

## Support

The SYNC support team is available:

- Monday-Saturday, 8:30am-8:00pm EST.
- United States: 1-888-270-1055
- Canada: 1-800-565-3673

**Note:** *Times are subject to change due to holidays.*

## Safety Information

### WARNING



Driving while distracted can result in loss of vehicle control, crash and injury. We strongly recommend that you use extreme caution when using any device that may take your focus off the road. Your primary responsibility is the safe operation of your vehicle. We recommend against the use of any handheld device while driving and encourage the use of voice-operated systems when possible. Make sure you are aware of all applicable local laws that may affect the use of electronic devices while driving

- Do not attempt to service or repair the system. Have your vehicle checked by an authorized dealer.
- Do not operate media devices if the power cables are broken or damaged.

# MyFord Touch™ (If Equipped)

- Make sure the power cables do not interfere with the safe operation of your vehicle's controls or affect your safe driving abilities.
- Some SYNC functions are speed-dependent. Their use is limited to when your vehicle is travelling at speeds below 3 mph (5 km/h).

Make sure that you review your device's manual before using it with SYNC.

## Speed-restricted Features

Some features of this system are restricted from use unless your vehicle is stationary.

- Screens crowded with information, for example:
  - Point of Interest reviews and ratings
  - SIRIUS Travel Link sports scores
  - Movie times
  - Ski conditions.
- Any action that requires keyboard use, for example: entering a navigation destination or editing information.
- All lists are limited, for example: phone contacts.

See the following chart for more specific examples.

<b>Restricted Features</b>	
Cell phone	Pairing a cell phone
	Adding or editing phonebook contacts
	Phone contacts and recent phone call entries
System Functionality	Enabling Valet Mode
	Editing settings while the rear view camera or active park assist are active
Wi-Fi and Wireless	Editing wireless settings
	Editing the list of wireless networks
Photos and Graphics	Adding or editing wallpaper
Text Messages	Composing text messages
	Viewing received text messages
	Editing preset text messages
Navigation	Using the keyboard to enter a destination
	Demo navigation route
	Adding or editing Address Book or Avoid Area entries

## Privacy Information

When you connect a cell phone to SYNC, the system creates a profile within your vehicle that links to that cell phone. This profile helps in offering you more cellular features and operating more efficiently. Among other things, this profile may contain data about your cell phone book, text messages (read and unread), and call history, including history of calls when your cell phone was not connected to the system. In addition, if you connect a media device, the system creates and retains an index of supported media content. The system also records a short development log of approximately 10 minutes of all recent system activity. The log profile and other system data may be used to improve the system and help diagnose any problems that may occur.

The cellular profile, media device index, and development log remain in your vehicle unless you delete them, and are generally accessible only in your vehicle when your cell phone or media player is connected. If you no longer plan to use the system or your vehicle, we recommend you carry out a Master Reset to erase all stored information.

System data cannot be accessed without special equipment and access to your vehicle's SYNC module. Ford Motor Company and Ford of Canada do not access the system data for any purpose other than as described without consent,

a court order, or where required by law enforcement, other government authorities, or other third parties acting with lawful authority. Other parties may seek to access the information independently of Ford Motor Company and Ford of Canada. For further privacy information, see the sections on 911 Assist®, Vehicle Health Report, and Traffic, Directions and Information.

## Using Voice Commands

This system helps you control many features using voice commands. This allows you to keep your hands on the wheel and focus on what is in front of you. The system provides feedback through audible tones, prompts, questions and spoken confirmations depending on the situation and the chosen level of interaction (voice settings).

The system also asks short questions (confirmation prompts) when it is not sure of your request or when there are multiple possible responses to your request.

When using voice commands, words and icons may appear in the lower left status bar indicating the status of the voice command session (such as Listening, Success, Failed, Paused or Try Again).

## How to Use Voice Commands



Press the voice command icon. After the tone, speak your voice command clearly.

### These voice commands can be said at any time during a voice command session

"Main menu"

"List of commands"

"What can I say?"

"Next page"

"Previous page"

# MyFord Touch™ (If Equipped)

## These voice commands can be said at any time during a voice command session

"Go back"

"Cancel"

"Exit"

"Help"

### What Can I Say?

To access the available voice commands for the current voice command session, do one of the following:

- During a voice command session, press the Help icon **?** in the lower left status bar of the screen.
- Say, "What can I say?" for an on-screen listing of the possible voice commands associated with your current voice command session.
- Press the voice command icon. After the tone, say, "Help" to hear a list of possible voice commands.

### Helpful Hints

- Make sure the interior of your vehicle is as quiet as possible. Wind noise from open windows and road vibrations may prevent the system from correctly recognizing spoken voice commands.
- After pressing the voice command icon, wait until after the tone sounds and Listening appears before saying a voice command. Any voice command spoken prior to this will not register with the system.

- Speak naturally, without long pauses between words.
- At any time, you can interrupt the system while it is speaking by pressing the voice command icon.

### Accessing a List of Available Voice Commands

If you use the touchscreen, press:

1. **Settings.**
2. **Help.**
3. **Voice Command List.**

If you use the steering wheel control, press the voice command button. After the tone, speak your voice command clearly.

## Available Voice Commands

"Audio list of commands"

"Radio list of commands"

"Bluetooth audio list of commands"

"SD card list of commands"

"Browse list of commands"

"Sirius satellite list of commands" \*

# MyFord Touch™ (If Equipped)

Available Voice Commands	
"CD list of commands"	"Travel link list of commands" *
"Climate control list of commands"	"USB list of commands"
"List of commands"	"Voice instructions list of commands"
"Navigation list of commands" *	"Voice settings list of commands"
"Phone list of commands"	"Help"

\* These voice commands are only available when your vehicle is fitted with a navigation system, and the navigation system SD card is in the SD card slot.

## Voice Command Settings

These allow you to customize the level of system interaction, help and feedback. The system defaults to standard interaction that uses candidate lists and confirmation prompts as these provide the highest level of guidance and feedback.

- **Interaction Mode:** Novice mode provides detailed interaction and guidance. Advanced mode has less audible interaction and more tone prompts.
- **Confirmation Prompts:** The system uses these short questions to confirm your voice command. If turned off, the system simply makes a best guess as to what you requested. The system may still occasionally ask you to confirm a voice command.
- **Phone and Media Candidate Lists:** Candidate lists are lists of possible results from your voice commands. The system creates these lists when it has the same confidence level of several options based on your voice command.

To access these settings using the touchscreen, press:

1. **Settings** icon.
2. **Settings.**
3. **Voice Control.**

Then select from the following:

- Interaction Mode
- Confirmation Prompts
- Media Candidate Lists
- Phone Candidate Lists
- Voice Control Volume.

To access these settings using voice commands, press the voice command icon. Wait for the prompt "Please say a command". Another tone sounds to let you know the system is listening.



## MyFord Touch™ (If Equipped)

---

<b>Voice command settings</b>
"Interaction mode novice"
"Interaction mode advanced"
"Confirmation prompts on"
"Confirmation prompts off"
"Phone candidate lists on"
"Phone candidate lists off"
"Media candidate lists on"
"Media candidate lists off"
"Help"

### ***Using Voice Commands with the Touchscreen Options***

The voice command system has a dual mode feature which allows you to switch between using voice commands and making on-screen selections. This is available only when the system displays a list of candidates generated during a voice command session. For example, when entering a street address or trying to call a contact from a cell phone paired to the system.

## SETTINGS



E161968

- A Clock
- B Display
- C Sound
- D Vehicle
- E Settings
- F Help



Under this menu, you can set your clock, access and adjust the display, sound and vehicle settings as well as access settings for specific modes or the help feature.

### Clock

To make adjustments using the touchscreen, press:

**Note:** You cannot manually set the date. Your vehicle's GPS does this for you.

**Note:** If the battery has been disconnected, your vehicle needs to acquire a GPS signal to update the clock. Once your vehicle acquires the signal, it may take a few minutes for the update to display the correct time.



1. **Settings** icon.
2. **Clock**.
3. **+ or -** to adjust the time.

# MyFord Touch™ (If Equipped)

From this screen, you can also make other adjustments such as 12-hour or 24-hour mode, activate GPS time synchronization and have the system automatically update new time zones.

You can also turn the outside air temperature display off and on. It appears at the top center of the touchscreen, next to the time and date.

The system automatically saves any updates you make to the settings.

## Display

You can adjust the touchscreen display through the touchscreen or by pressing the voice button on the steering wheel controls and when prompted, say, "Display settings".



To make adjustments using the touchscreen, press:

1. **Settings** icon.
2. **Display**.

Then select from the following:

- **Brightness** allows you to make the screen display brighter or dimmer.
- **Mode** allows you to turn the display off. It also allows you to set the screen to a certain brightness or have the system automatically change based on the outside light level.
  - If you select **AUTO** or **NIGHT**, you have the options of turning the display's Auto Dim feature on or off and changing the Auto Dim Manual Offset feature.
- **Edit Wallpaper** allows you to display the default photo or upload your own.

## Uploading Photos for Your Home Screen Wallpaper

**Note:** You cannot load photos directly from your camera. You must access the photos either from your USB mass storage device or from an SD card.

**Note:** Photographs with extremely large dimensions (such as 2048 x 1536) may not be compatible and appear as a blank (black) image on the display.

Your system allows you to upload and view up to 32 photos.



To access, press:

1. **Settings** icon.
2. **Display**.
3. **Edit Wallpaper**.
4. follow the system prompts to upload your photographs.

Only the photograph(s), which meets the following conditions, display:

- Compatible file formats are as follows: .jpg, .gif, .png, .bmp
- Each file must be 1.5 MB or less.
- Recommended dimensions: 800 x 384

## Sound



To make adjustments using the touchscreen, press:

1. **Settings** icon.
2. **Sound**.

Then select from the following:

- Bass
- Midrange
- Treble
- Set Balance and Fade
- Occupancy Mode

- Speed Compensated Volume
- DSP.\*

**Note:** \* *Your vehicle may not have these sound settings.*

## Vehicle



To make adjustments using the touchscreen, press:

1. **Settings** icon.
2. **Vehicle**.

Then select from the following:

- Active Park Assist
- Vehicle Health Report
- Rear View Camera
- Enable Valet Mode
- MyKey
- Traction Control
- Electronic Stability Control
- Hill Start Assist

## Active Park Assist

When activated, your system displays directions for you regarding the active park assist process.

You can find more information on the active park assist system in another chapter. See **Parking Aids** (page 138).

## Vehicle Health Report

Turn **Automatic Reminders** on and off and set the mileage interval at which you would like to receive the reports. Press the **?** for more information on these selections.

When done making your selections, press **Run Vehicle Health Report Now** if you want your report.

You can find more information on Vehicle Health Report in this chapter.

## Rear View Camera

This menu allows you to access settings for your rear view camera.



To make adjustments using the touchscreen, press:

1. **Settings** icon.
2. **Vehicle**.
3. **Rear View Camera**.

Then select from the following:

- Rear Camera Delay
- Visual Park Aid Alert
- Guidelines.

You can find more information on the rear view camera system in another chapter. See **Parking Aids** (page 138).

## Enable Valet Mode

**Note:** *If the system locks, and you need to reset the PIN, enter 3681 and the system unlocks.*

Valet mode allows you to lock the system. No information is accessible until the system is unlocked with the correct PIN.



To access, press:

1. **Settings** icon.
2. **Vehicle**.
3. **Enable Valet Mode**.
4. **Continue**

**Note:** *After you press Continue the system locks until you enter the PIN again.*

## Settings

Access and adjust system settings, voice features, as well as phone, navigation and wireless settings.

# MyFord Touch™ (If Equipped)

## System



To access, press:

1. **Settings** icon.
2. **Settings**.
3. **System**.

Then select from the following:

System	
Language	Select to have the touchscreen display in English, Spanish or French.
Distance	Select to display units in kilometers or miles.
Temperature	Select to display units in Celsius or Fahrenheit.
System Prompt Volume	Adjust the volume of voice prompts from the system.
Touch Screen Button Beep	Select to have the system beep to confirm choices made through the touchscreen.
Touch Panel Button Beep	Select to have the system beep to confirm button choices made through the climate or audio system.
Keyboard Layout	Have the touchscreen keyboard display in QWERTY or ABC format.
Install Applications	Install any downloaded applications or view the current software licenses.
Master Reset	Select to restore factory defaults. This erases all personal settings and personal data.

## Voice Control



To access, press:

1. **Settings** icon.
2. **Settings**.
3. **Voice Control**.

Then select from the following:

Voice Control	
Interaction Mode	Standard interaction mode provides more detailed interaction and guidance. Advanced mode has less audible interaction and more tone prompts.
Confirmation Prompts	Have the system ask you short questions if it has not clearly heard or understood your request.

## MyFord Touch™ (If Equipped)

Voice Control	
	<b>Note:</b> Even with confirmation prompts turned off, the system may occasionally ask you to confirm settings.
Media Candidate Lists	Candidate lists are possible results from your voice commands. The system simply makes a best guess at your request with these turned off.
Phone Candidate Lists	Candidate lists are possible results from your voice commands. The system simply makes a best guess at your request with these turned off.
Voice Control Volume	This allows you to adjust the system's voice volume level.

### Media Player



To access, press:

1. **Settings** icon.
2. **Settings**.
3. **Media Player**.

Then select from the following:

Media Player	
Autoplay	When this feature is on, the system automatically switches to the media source upon initial connection. This allows you to listen to music during the indexing process. When this feature is off, the system does not automatically switch to the inserted media source.
Bluetooth Devices	Select to connect, disconnect, add or delete a device. You can also set a device as your favorite so that the system automatically attempts to connect to that device at every ignition cycle.
Gracenote® Database Info	This allows you to view the version level of the Gracenote Database.
Gracenote® Mgmt	With this feature on, the Gracenote Database supplies metadata information for your music files. This overrides information from your device. This feature defaults to off.
Cover Art Priority	With this feature on, the Gracenote Database supplied cover art for your music files. This overrides any art from your device. This feature defaults to Media Player.

# MyFord Touch™ (If Equipped)

## Navigation



To access, press:

1. **Settings** icon,
2. **Settings**,
3. **Navigation**,

Then select from the following:

<b>Navigation</b>	
Map Preferences	Turn breadcrumbs on and off.
	Have the system display your turn list top to bottom or bottom to top.
	Turn the Parking POI notification on and off.
Route Preferences	Select shortest route, fastest route or ecological route as your preferred route. This route will be displayed first.
	Always use preferred route. If set to yes, the system will only calculate a single route. This speeds up your destination entry process.
	Select a low, medium or high cost for the calculated ecological route. This may incur a time penalty.
	Have the system avoid freeways.
	Have the system avoid tollroads.
	Have the system avoid ferries or car trains.
	Have the system use HOV (high-occupancy vehicle) lanes.
Navigation Preferences	Have the system use guidance prompts.
	Have the system automatically fill-in State/Province information.
Traffic Preferences	Have the system automatically avoid traffic concerns or allow you to accept or decline an alternative route.
	Have the system automatically alert you to traffic concerns that occur on your route.
	Have the system display areas where roadwork occurs.
	Have the system display incident icons.
	Have the system display areas where difficult driving conditions may occur.

## MyFord Touch™ (If Equipped)

Navigation	
	Have the system display areas with snow and ice on the road may occur.
	Have the system display any smog alerts.
	Have the system display weather warnings.
	Have the system display where there may be reduced visibility.
	Have the system turn on your radio for traffic announcements.
Avoid Areas	Enter specific areas that would like to avoid on planned navigation routes.

### Phone



To access, press:

1. **Settings** icon.
2. **Settings**.
3. **Phone**.

Then select from the following:

Phone	
Bluetooth Devices	Connect, disconnect, add or delete a device, as well as save it as a favorite.
Bluetooth	Turn Bluetooth on and off.
Do Not Disturb	Have all calls go directly to your voice mail and not ring inside your vehicle. With this feature turned on, text message notifications are also suppressed and do not ring inside your vehicle.
911 Assist	Turn on or turn off the 911 Assist feature. See <b>Information</b> (page 337).
Phone Ringer	Select the type of notification for phone calls - ring tone, beep, text to speech, or have it be silent.
Text Message Notification	Select the type of notification for text messages - alert tone, beep, text to speech, or have it be silent.



# MyFord Touch™ (If Equipped)

Phone	
Internet Data Connection	If compatible with your phone, you can adjust your internet data connection. Select to make your connection profile with the personal area network or to turn off your connection. You can also choose to adjust your settings or have the system always connect, never connect when roaming or query on connect. Press <b>?</b> for more information.
Manage Phonebook	Access features, such as automatic phonebook download, re-download your phonebook, add contacts from your phone as well as delete or upload your phonebook.
Roaming Warning	Have the system alert you when in Roaming mode.

## Wireless & Internet

Your system has a Wi-Fi feature that creates a wireless network within your vehicle, thereby allowing other devices (such as personal computers or phones) in your vehicle to speak to each other, share files or play games. Using this Wi-Fi feature, everyone in your vehicle can also gain access the internet if you have a USB mobile broadband connection inside your vehicle, your phone supports personal area networking and if you park outside a wireless hotspot.



To access, press:

1. **Settings** icon.
2. **Settings**.
3. **Wireless & Internet**.

Then select from the following:

Wi-Fi	
Wi-Fi Settings	<p><b>Wi-Fi Network (Client) Mode</b> turns the Wi-Fi feature on and off in your vehicle. Make sure you turn it on for connectivity purposes.</p> <p><b>Choose a Wireless Network</b> allows you to use a previously stored wireless network. You can categorize by alphabetical listing, priority and signal strength. You can also choose to search for a network, connect to a network, disconnect from a network, receive more information, prioritize a network or delete a network.</p> <p><b>Gateway (Access Point) Mode</b> makes SYNC an access point for a phone or a computer when turned on. This forms the local area network within your vehicle for things, such as game playing, file transfer and internet browsing. Press <b>?</b> for more information.</p>

## MyFord Touch™ (If Equipped)

<b>Wi-Fi</b>	
	<p><b>Gateway (Access Point) Settings</b> allows you to view and change settings for using SYNC as the internet gateway.</p> <p><b>Gateway (Access Point) Device List</b> allows you to view recent connections to your Wi-Fi system.</p>
USB Mobile Broadband	<p>Instead of using Wi-Fi, your system can also use a USB mobile broadband connection to access the internet. (You must turn on your mobile broadband device on your personal computer before connecting it to the system.) This screen allows you to set up what is your typical area for your USB mobile broadband connection. (USB mobile broadband settings may not display if the device is already on.) You can select the following: Country, Carrier, Phone Number, User Name and Password.</p>
Bluetooth Settings	<p>Shows you the currently paired devices as well as giving you your typical Bluetooth options to connect, disconnect, set as favorite, delete and add device. Bluetooth is a registered trademark of the Bluetooth SIG.</p>
Prioritize Connection Methods	<p>Choose your connection methods and change them as needed. You can select to Change Order and have the system either always attempt to connect using a USB mobile broadband or using Wi-Fi.</p>



E142626

The Wi-Fi CERTIFIED Logo is a certification mark of the Wi-Fi Alliance.

### Help



To access, press:

1. **Settings** icon.
2. **Help**.

Then select from the following:

## MyFord Touch™ (If Equipped)

<b>Help</b>	
Where Am I?	View your vehicle's current location, if your vehicle is equipped with navigation. If your vehicle is not equipped with navigation, nothing displays.
System Information	Touchscreen system serial number
	Your vehicle identification number (VIN)
	Touchscreen system software version
	Navigation system version
	Map database version
	Sirius satellite radio ESN
	Gracenote® Database Information and Library version
Software Licenses	View the licenses for any software and applications installed on your system.
Driving Restrictions	Certain features are not accessible when your vehicle is moving.
911 Assist	Turn on and turn off the 911 Assist feature. See <b>Information</b> (page 337). <b>In Case of Emergency (ICE) Quick Dial:</b> allows you to save up to two numbers as ICE contacts for quick access if there is an emergency. Select <b>Edit</b> to access your phonebook and then select the desired contacts. The numbers then appear as options on this screen for the ICE 1 and ICE 2 buttons. The ICE contacts you select appear at the end of the 911 Assist call process.
Voice Command List	View categorized lists of voice commands.

To access Help using the voice commands, press the voice button, then, after the tone, say "Help". The system provides allowable voice commands for the current mode.

## ENTERTAINMENT

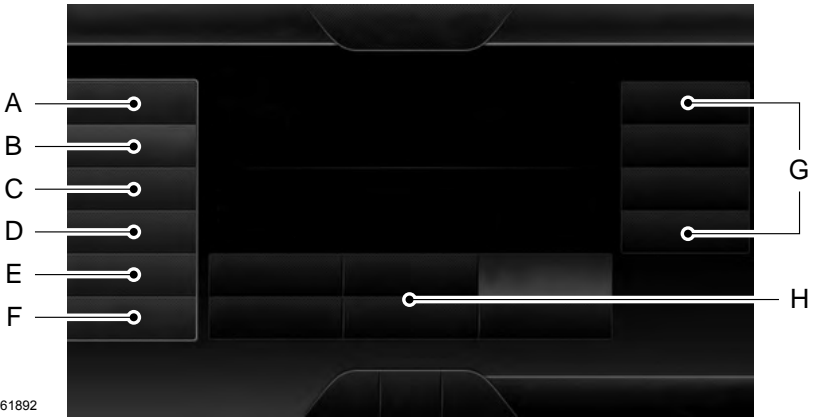

E161892

- A AM 1, and AM AST
- B FM 1, FM 2 and FM AST
- C SIRIUS
- D CD
- E USB
- F Touch this button to scroll down for more options, such as SD Card, BT Stereo and Line In
- G These buttons change with the media mode you are in.
- H Radio memory presets and CD controls.

**Note:** Some features may not be available in your area. Contact an authorized dealer for more information.

You can access these options using the touchscreen or voice commands.

### Browsing Device Content

When listening to any type of audio, you can browse through other devices without having to change sources. For example, if you are currently listening to the radio, you can browse all the artists that are stored on your USB device.



Press the voice icon on the steering wheel. When prompted, you can say:

## MyFord Touch™ (If Equipped)

---

<b>"BROWSE" within devices</b>
"Browse"
"Browse <league> games"***
"Browse <Sirius category> channels"***
"Browse SD card"
"Browse Sirius channel guide"***
"Browse USB"
"Help"

\* If you only say, "Browse", you can then say any commands in the following chart.

\*\*\*This command is only usable if you have an active subscription to SIRIUS® satellite radio.

<b>"BROWSE"</b>
"<League> Games"*
"<Sirius category> channels"*
"SD card"*
"Sirius Channel Guide"*
"USB"***
"Help"

\* This command is only usable if you have an active subscription to SIRIUS® satellite radio.

\*\* For more commands in SD card or USB mode, see the "SD Card and USB Port" section of this chapter.

## MyFord Touch™ (If Equipped)

Sample commands
"<87.9-107.9>"
"<530-1710>"
"<Channel name>".
"AM <530-1710>"
"FM <87.9-107.9>"
"Play [album] <name>".**
"Play [artist] <name>".**
"Play [genre] <name>".**
"Play [playlist] <name>".**
"Play [song] <name>".**
"Play <name>"
"Play <name (song or album)> by <artist name>"
"Sirius <0-223>".
"Sports games".

\* This command is only usable if you have an active subscription to SIRIUS satellite radio.

\*\* The commands that have [ ] around the word means that the word is optional. For example, if you say, "Play Metallica", this is the same as the voice command, "Play [artist] <name>".

### AM/FM Radio



Touch the **AM** or **FM** tab to listen to the radio.

To change between AM and FM presets, just touch the **AM** or **FM** tab.

### Memory Presets

Save a station by pressing and holding one of the memory preset areas. There is a brief mute while the radio saves the station. Sound returns when finished.

## HD Radio

Touch this button to turn HD Radio on. The light on the button illuminates when the feature is on. HD Radio allows you to receive radio broadcasts digitally, where available, providing free, crystal-clear sound. See HD Radio information later in this chapter.

## Scan

Touch this button to go to the next strong AM or FM radio station. The light on the button illuminates when the feature is on.

## Options

### Sound Settings

Touch this button to adjust settings for:

- Bass
- Midrange
- Treble
- Balance and Fade
- DSP (Digital Signal processing)
- Occupancy Mode
- Speed Compensated Volume.

**Note:** *Your vehicle may not have all these sound settings.*

### Set PTY for Seek/Scan

This allows you to select a category of music you would like to search for. You can then choose to either seek or scan for the stations playing that category.

### RDS Text Display

This allows you to view the information broadcast by FM stations.

## AST

AST (Autostore) allows you to have the system automatically store the six strongest stations in your current location.

## TAG Button

This feature is available when HD Radio is on, and allows you to tag a song to download later. When you select On, **TAG** appears on-screen when HD Radio is active. You can touch **TAG** to save the information of the song that is playing. When you plug in your portable music player, the information transfers, if supported by your device. When you are connected to iTunes®, the tags appear to remind you of the songs you would like to download. See HD Radio information later in this chapter.

## Direct Tune

Touch this button to enter the desired station number when prompted. Touch **Enter** when you are done.

## HD Radio™ Information (If Available)

**Note:** *HD Radio broadcasts are not available in all markets.*

HD Radio technology is the digital evolution of analog AM/FM radio. Your system has a special receiver that allows it to receive digital broadcasts (where available) in addition to the analog broadcasts, it already receives. Digital broadcasts provide a better sound quality than analog broadcasts with free, crystal-clear audio and no static or distortion. For more information, and a guide to available stations and programming, please visit [www.hdradio.com](http://www.hdradio.com).

When HD Radio is on and you tune to a station broadcasting HD Radio technology, you may notice the following indicators on your screen:



E142616

The HD Radio logo blinks when acquiring a digital station and stays solid when digital audio is playing. When this logo is available, you may also see Title and Artist fields on-screen.

The multicast indicator appears in FM mode (only) if the current station is broadcasting multiple digital broadcasts. The highlighted numbers signify available digital channels where new or different content is available. HD1 signifies the main programming status and is available in analog and digital broadcasts. Other multicast stations (HD2 through HD7) are only available digitally.

**TAG** allows you to save a song to download later when you are on an acquired HD Radio station and the feature is on. To turn the feature on and use it, press:

1. **AM** or **FM**.
  2. **Options**.
  3. **TAG Button**.
  4. **On**.
5. When you hear a song you like, press **TAG**.

The system automatically saves the song's information and transfers it to your portable music player (if supported) when you connect it to the system. The system automatically transfers the tag to your player (if already connected) and a pop-up confirms the transfer.

When you access iTunes® with your portable music player, the tags appear to you as a reminder. The system allows you to tag up to approximately 100 songs. For a list of devices that support tagging, see [www.SYNCMyRide.com](http://www.SYNCMyRide.com), [www.SYNCMyRide.ca](http://www.SYNCMyRide.ca) or [www.syncmaroute.ca](http://www.syncmaroute.ca).

When HD Radio broadcasts are active, you can access the following functions:

- **Scan** allows you to hear a brief sampling of all available stations. This feature still works when HD Radio reception is on, although it does not scan for HD2-HD7 channels. You may see the HD logo appear if the station has a digital broadcast.
- **Memory presets** allow you to save an active channel as a memory preset. Touch and hold a memory preset slot until the sound returns. There is a brief mute while the radio saves the station. Sound returns when finished. When switching to an HD2 or HD3 memory preset, the sound mutes before the digital audio plays, because the system has to reacquire the digital signal.

**Note:** *As with any saved radio station, you cannot access the saved station if your vehicle is outside the station's reception area.*



# MyFord Touch™ (If Equipped)

## HD Radio Reception and Station Troubleshooting

<b>Potential reception issues</b>	
Reception area	If you are listening to a multicast station and you are on the fringe of the reception area, the station may mute due to weak signal strength.
	If you are listening to HD1, the system switches back to the analog broadcast until the digital broadcast is available again. However, if you are listening to any of the possible HD2-HD7 multicast channels, the station mutes and stays muted unless it is able to connect to the digital signal again.
Station blending	When the system first receives a station (aside from HD2-HD7 multicast stations), it first plays the station in the analog version. Once the receiver verifies the station is an HD Radio station, it shifts to the digital version. Depending on the station quality, you may hear a slight sound change when the station changes from analog to digital. Blending is the shift from analog to digital sound or digital back to analog sound.

In order to provide the best possible experience, use the contact form to report any station issues found while listening to a station broadcasting with HD Radio technology. Independent entities own and operate each station. These stations are responsible for ensuring all audio streams and data fields are accurate.

## MyFord Touch™ (If Equipped)

Potential station issues		
Issues	Cause	Action
Echo, stutter, skip or repeat in audio. Increase or decrease in audio volume.	This is poor time alignment by the radio broadcaster.	No action required. This is a broadcast issue.
Sound fading or blending in and out.	The radio is shifting between analog and digital audio.	No action required. The reception issue may clear up as you continue to drive.
There is an audio mute delay when selecting HD2 or HD3, multicast preset or <b>Direct Tune</b> .	The digital multicast is not available until the HD Radio broadcast is decoded. Once decoded, the audio is available.	No action required. This is normal behavior. Wait until the audio is available.
Cannot access HD2 or HD3 multicast channel when recalling a preset or from a direct tune.	The previously stored multicast preset or direct tune is not available in your current reception area.	No action required. The station is not available in your current location.
Text information does not match currently playing audio.	Data service issue by the radio broadcaster.	Fill out the station issue form at website listed below.*
There is no text information shown for currently selected frequency.	Data service issue by the radio broadcaster.	Fill out the station issue form at website listed below.*
HD2-HD7 stations not found when <b>Scan</b> is pressed.	Pressing <b>Scan</b> disables HD2-HD7 channel search.	No action required. This is normal behavior.

\* [http://www.ibiquity.com/automotive/report\\_radio\\_station\\_experiences](http://www.ibiquity.com/automotive/report_radio_station_experiences)

HD Radio Technology manufactured under license from iBiquity Digital Corp. U.S. and foreign patents. HD Radio and the HD and HD Radio logos are proprietary trademarks of iBiquity Digital Corp. Ford Motor Company and iBiquity Digital Corp. are not responsible for the content sent using HD Radio technology. Content may be changed, added or deleted at any time at the station owner's discretion.

### Radio Voice Commands



If you are listening to the radio, press the voice button on the steering wheel controls. When prompted, say any of the following commands.

If you are not listening to the radio, press the voice button and, after the tone, say "Radio", then any of the following commands.

## MyFord Touch™ (If Equipped)

<b>"RADIO"</b>	
"<87.9-107.9>"	"FM autosest preset <#>"
"<87.9-107.9> HD" <sup>1</sup>	"FM preset <#>"
"<530-1710>"	"FM 1"
"AM"	"FM 1 preset <#>"
"AM <530-1710>"	"FM 2"
"AM autosest"	"FM 2 preset <#>"
"AM autosest preset <#>"	"HD <#>" <sup>1</sup>
"AM preset <#>"	"Preset <#>"
"Browse" <sup>2</sup>	"Radio off"
"FM"	"Radio on"
"FM <87.9-107.9>"	"Set PTY"
"FM <87.9-107.9> HD <#>" <sup>1</sup>	"Tune" <sup>3</sup>
"FM autosest"	"Help"

<sup>1</sup> If available

<sup>2</sup> If you have said "Browse", see the "Browse" chart later in this section.

<sup>3</sup> If you have said "Tune", see the following "Tune" chart.

<b>"TUNE"</b>	
"<530-1710>"	"FM autosest"
"<87.9-107.9> HD <#>" <sup>*</sup>	"FM autosest preset <#>"
"AM"	"FM preset <#>"
"AM <530-1710>"	"FM1"
"AM preset <#>"	"FM1 preset <#>"
"AM autosest"	"FM2"
"AM autosest preset <#>"	"FM2 preset <#>"

# MyFord Touch™ (If Equipped)

"TUNE"	
"<87.9-107.9>"	"HD <#>"*
"FM"	"Preset <#>"
"FM <87.9-107.9>"	"Help"
"FM <87.9-107.9> HD <#>"*	

\* If available

## SIRIUS® Satellite Radio (If Activated)



Press the lower left corner of the touchscreen, and then select the **SIRIUS** tab.

### Memory Presets

Save a channel by pressing and holding one of the memory preset areas. There is a brief mute while the radio saves the channel. Sound returns when finished.

### ALERT

Save the current song, artist, or team as a favorite. The system alerts you when it plays again on any channel.

### Replay

Replay audio on the current channel. You can replay approximately 45 minutes of audio as long as you have remained tuned to the current station. Changing stations erases the previous audio.

While in replay mode:

- Press and release the seek buttons to hear the previous or next song.
- Press and hold the seek buttons to reverse or fast forward in the current track.

- Press play or pause to play or pause the audio.
- Press **Replay** to return to live audio if you have been using the feature to replay audio.

### Scan

Touch this button to hear a brief sampling of channels.

### Options

Touch this button to view and adjust various media settings.

### Sound Settings

Touch this button to adjust settings for:

- Bass
- Midrange
- Treble
- Balance and Fade
- DSP (Digital Signal processing)
- Occupancy Mode
- Speed Compensated Volume.

**Note:** *Your vehicle may not have all these sound settings.*

### Set Category for Seek/Scan

This allows you to select a category of music you would like to search for. You can then choose to either seek or scan for the stations playing that category.

# MyFord Touch™ (If Equipped)

## Parental Lockout

This allows you to lock and unlock channels, change or reset your PIN or unlock all channels. To use this feature, you need your initial PIN, which is 1234.

## Artist/Title/Team Alerts

This feature allows you to select Artists, Titles and Teams that you would like the system to alert you to when they are playing on other channels. Press Edit Alerts to delete or turn off alerts. You can also set all alerts to on or off. When an alert appears on the screen, you can choose to Tune to the channel, to Cancel the alert or to Disable Alerts. If you are listening to a sporting event, you can save your favorite teams so that the system can alert you when they are playing on a satellite radio channel.

**Note:** SIRIUS does not support the Alert feature on all channels. Ford Motor Company shall not be responsible for Alert feature variation.

## Electronic Serial Number (ESN)

SIRIUS requires this number when communicating with you about your account.

## Direct Tune

Touch this button to enter the satellite channel number when prompted. Touch **Enter** when you are done.

## Browse

Touch this button to view a list of all available stations. Scroll to see more categories. Touch the station you want to listen to.

Touch **Skip** if you want to skip this channel.

Touch **Lock** if you do not want anyone to listen to this channel.

Touch **Title** or **Artist** to see song and artists on other stations.

## SIRIUS Satellite Radio Information

**Note:** SIRIUS reserves the unrestricted right to change, rearrange, add or delete programming including canceling, moving or adding particular channels, and its prices, at any time, with or without notice to you. Ford Motor Company shall not be responsible for any such programming changes.



E142593

SIRIUS satellite radio is a subscription-based satellite radio service that broadcasts a variety of music, sports, news, weather, traffic and entertainment programming. Your factory-installed SIRIUS satellite radio system includes hardware and a limited subscription term that begins on the date of sale or lease of your vehicle. See an authorized dealer for availability.

For more information on extended subscription terms (a service fee is required), the online media player and a list of SIRIUS satellite radio channels, and other features, please visit [www.siriusxm.com](http://www.siriusxm.com) in the United States, [www.sirius.ca](http://www.sirius.ca) in Canada, or call SIRIUS at 1-888-539-7474.

**Note:** This receiver includes the eCos real-time operating system. eCos is published under the eCos License.

## MyFord Touch™ (If Equipped)

### Satellite Radio Electronic Serial Number (ESN)

You need your ESN to activate, modify or track your satellite radio account. The ESN is on the System Information Screen (SR

ESN:XXXXXXXXXXXX). To access your ESN, press the bottom left corner of the touchscreen, then Press:

1. **SIRIUS.**
2. **Options.**

### SIRIUS Satellite Radio Reception Factors and Troubleshooting

Potential reception issues	
Antenna obstructions	For optimal reception performance, keep the antenna clear of snow and ice build-up and keep luggage and other materials as far away from the antenna as possible.
Terrain	Hills, mountains, tall buildings, bridges, tunnels, freeway overpasses, parking garages, dense tree foliage and thunderstorms can interfere with your reception.
Station overload	When you pass a ground-based broadcast-repeating tower, a stronger signal may overtake a weaker one and the audio system may mute.
Satellite radio signal interference	Your display may show ACQUIRING... to indicate the interference and the audio system may mute.

Troubleshooting tips		
Radio display	Cause	Action
Acquiring...	Radio requires more than two seconds to produce audio for the selected channel.	No action required. This message should disappear shortly.
Sat Fault/SIRIUS System Failure.	There is an internal module or system failure present.	If this message does not clear shortly, or with an ignition key cycle, your receiver may have a fault. See an authorized dealer for service.
Invalid Channel.	The channel is no longer available.	Tune to another channel or choose another preset.
Unsubscribed Channel.	Your subscription does not include this channel.	Contact SIRIUS at 1-888-539-7474 to subscribe to the channel, or tune to another channel.

## MyFord Touch™ (If Equipped)

Troubleshooting tips		
Radio display	Cause	Action
No Signal.	The signal is lost from the SIRIUS satellite or SIRIUS tower to your vehicle antenna.	The signal is blocked. When you move into an open area, the signal should return.
Updating.	Update of channel programming in progress.	No action required. The process may take up to three minutes.
Call SIRIUS 1-888-539-7474.	Your satellite service is no longer available.	Contact SIRIUS at 1-888-539-7474 to resolve subscription issues.
No Channels Available.	All the channels in the selected category are either skipped or locked.	Use the channel guide to turn off the Lock or Skip function on that station.
Subscription Updated.	SIRIUS has updated the channels available for your vehicle.	No action required.

### SIRIUS Satellite Radio Voice Commands



If you are listening to SIRIUS satellite radio, press the voice button on the steering wheel controls. When prompted, say any of the following commands.

If you are not listening to SIRIUS satellite radio, press the voice button and, after the tone, say "SIRIUS", then any of the following commands.

"SIRIUS"	
"SIRIUS <0-223>"	"SAT 2 preset <#>"
"<Channel name>"	"SAT 3"
"Preset <#>"	"SAT 3 preset <#>"
"SAT"	"SIRIUS off"
"SAT preset <#>"	"SIRIUS on"
"SAT 1"	"Sports game"

## MyFord Touch™ (If Equipped)

<b>"SIRIUS"</b>	
"SAT 1 Preset <#>"	"Tune"***
"SAT 2"	"Help"

\* If you have said "Sports game", see the following "Sports game" chart.

\*\* If you have said "Tune", see the following "Tune" chart.

<b>"SPORTS GAME"</b>
"Tune to the <college name> game"
"Tune to the <team city> game"
"Tune to the <team city> <team name> game"
"Tune to the <team name> game"
"Help"

<b>"TUNE"</b>
"<0-223>"
"<Channel Name>"
"Preset <#>"
"SAT"
"SAT 1"
"SAT 1 preset <#>"
"SAT 2"
"SAT 2 preset <#>"
"SAT 3"
"SAT 3 preset <#>"
"Help"



# MyFord Touch™ (If Equipped)

## CD



Press the lower left corner of the touchscreen and press the **CD** tab.

You can also advance and reverse the current track or current folder, if applicable.

### Repeat

Touch this button to repeat the currently playing track, all tracks on the disc or turn the feature off if already on.

### Shuffle

Touch this button to play the tracks or entire albums in random order, or turn the feature off if already on.

### Scan

Touch this button to hear a brief sampling of all available tracks.

### More Info

Touch this button to see disc information.

### Options

#### Sound Settings

Touch this button to adjust settings for:

- Bass
- Midrange
- Treble
- Balance and Fade
- DSP (Digital Signal processing)
- Occupancy Mode
- Speed Compensated Volume.

**Note:** *Your vehicle may not have all these sound settings.*

#### Compression

Touch this button to turn the compression feature on and off.

#### Browse

Touch this button to look through all available CD tracks.

#### CD Voice Commands



If you are listening to a CD, press the voice button on the steering wheel controls. When prompted, say any of the following commands.

If you are not listening to a CD, press the voice button and, after the tone, say "CD", then any of the following commands.

"CD"
"Pause"
"Play"
"Play next track"
"Play previous track"
"Play track <1-512>"
"Repeat"
"Repeat folder"

## MyFord Touch™ (If Equipped)

"CD"
"Repeat off"
"Repeat track"
"Shuffle"
"Shuffle CD"*
"Shuffle folder"*
"Shuffle off"
"Help"

\*This applies to WMA or MP3 files only.

### SD Card Slot and USB Port

#### SD Card

**Note:** Your SD card slot is spring-loaded. To remove the SD card, press the card in and the system ejects it. Do not attempt to pull the card to remove it as this could cause damage.

**Note:** The navigation system also uses this card slot. See **Navigation** (page 346).



E142620

SD logo is a trademark of SD-3C, LLC.

#### USB Port

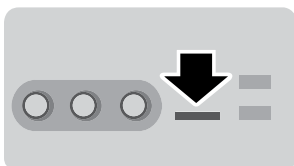

E142619

The SD card slot is located either in the center console or behind a small access door in the instrument panel. To access and play music from your device, press the lower left corner of the touchscreen.

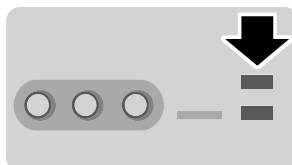

E142621

The USB ports are located either in the center console or behind a small access door in the instrument panel. To access and play music from your device, press the lower left corner of the touchscreen.

## MyFord Touch™ (If Equipped)

This feature allows you to plug in media playing devices, memory sticks, flash drives or thumb drives, and charge devices if they support this feature.

In order to playback video from your iPod® or iPhone®, you must have a special combination USB/RCA composite video cable (which you can buy from Apple®). When the cable is connected to your iPod® or iPhone®, plug the other end into both the RCA jacks and the USB port.

### Playing Music from Your Device



Insert your device and select the **SD Card** or **USB** tab once the system recognizes it. You can then select from the following options:

#### Repeat

This feature replays the currently playing song or album.

#### Shuffle

Touch this button to play music on the selected album or folder in random order.

#### Similar Music

This feature allows you to choose music similar to what is currently playing.

#### More Info

Touch this button to see disc information such as current track, artist name, album and genre.

#### Options

Touch this button to view and adjust various media settings.

**Sound Settings** allows you to adjust settings for:

- Bass
- Midrange

- Treble
- Balance and Fade
- DSP (Digital Signal processing)
- Occupancy Mode
- Speed Compensated Volume.

**Note:** *Your vehicle may not have all these sound settings.*

**Media Player Settings** allows you to select more settings, which is under Media Player. See **Settings** (page 303).

**Device Information** displays software and firmware information about the currently connected media device.

**Update Media Index** indexes your device each time you connect it to make sure you have the latest voice commands available for all media on the device.

#### Browse

This feature allows you to view the contents of the device. It also allows you to search by categories, such as genre, artist or album.

If you want to view song information such as Title, Artist, File, Folder, Album, and Genre, touch the on-screen album art.

You can also touch **What's Playing** to hear how the system pronounces the current band and song. This can be helpful when using voice commands to make sure the system correctly plays your request.

#### SD Card and USB Voice Commands



If you are listening to a USB device or an SD card, press the voice button on the steering wheel controls. When prompted, say any of the following commands.

If you are not listening to a USB device or an SD card, press the voice button and, after the tone, say "USB" or "SD card", then any of the following commands.

## MyFord Touch™ (If Equipped)

<b>"USB" or "SD CARD"</b>	
"Browse"	"Play podcast episode <name>"
"Next"	"Play similar music"
"Pause"	"Play song <name>"
"Play"	"Play TV show <name>"**
"Play album <name>"	"Play TV show episode <name>"**
"Play all"	"Play video <name>"**
"Play artist <name>"	"Play video podcast episode <name>"**
"Play audiobook <name>"	"Play video playlist <name>"**
"Play author <name>"	"Previous"
"Play composer <name>"	"Repeat all"
"Play folder <name>"	"Repeat off"
"Play genre <name>"	"Repeat one"
"Play movie <name>"**	"Shuffle"
"Play music video <name>"**	"Shuffle off"
"Play playlist <name>"	"What's this?"
"Play podcast <name>"	"Help"
"Play video podcast <name>"	

\* If you have said you would like to browse your USB or SD card, the system prompts you to specify what you would like to browse. When prompted, see the following "Browse" chart.

\*\* These commands are only available in USB mode and are device-dependent.

## MyFord Touch™ (If Equipped)

<b>"BROWSE"</b>	
"Album <name>"	"All video podcasts"*
"All albums"	"All videos"
"All artists"	"Artist <name>"
"All audiobooks"	"Audiobook <name>"
"All authors"	"Author <name>"
"All composers"	"Composer <name>"
"All folders"	"Folder <name>"
"All genres"	"Genre <name>"
"All movies"	"Playlist <name>"
"All music videos"*	"Podcast <name>"
"All playlists"	"TV show <name>"*
"All podcasts"	"Video <name>"*
"All songs"	"Video playlist <name>"*
"All TV shows"*	"Video podcast <name>"*
"All video playlists"*	"Help"

\* These commands are only available in USB mode and are device-dependent.

### Supported Media Players, Formats and Metadata Information

SYNC is capable of hosting nearly any digital media player, including iPod®, Zune™, plays from device players, and most USB drives. Supported audio formats include MP3, WMA, WAV and AAC.

It is also able to organize your indexed media from your playing device by metadata tags. Metadata tags, which are descriptive software identifiers embedded in the media files, provide information about the file.

If your indexed media files contain no information embedded in these metadata tags, SYNC may classify the empty metadata tags as **Unknown**.

## MyFord Touch™ (If Equipped)

In order to playback video from your iPod® or iPhone®, you must have a special combination USB/RCA composite video cable (which you can buy from Apple®). When the cable is connected to your iPod® or iPhone®, plug the other end into both the RCA jacks and the USB port.

### Bluetooth Audio

Your system allows you to stream audio over your vehicle's speakers from your connected, Bluetooth-enabled cellular phone.



To access, press the lower left corner on the touchscreen, then select the **BT Stereo** tab.

### Bluetooth Audio Voice Commands



If you are listening to a Bluetooth audio device, press the voice button on the steering wheel control. When prompted, say "Next song", "Pause", "Play" or "Previous song".

If you are not listening to a Bluetooth audio device, press the voice button and, after the tone, say "Next song", "Pause", "Play" or "Previous song".

## PHONE



E161968

- A Phone
- B Quick Dial
- C Phonebook
- D History
- E Messaging
- F Settings

# MyFord Touch™ (If Equipped)

Hands-free calling is one of the main features of SYNC®. Once you pair your phone, you can access many options using the touchscreen or voice commands. While the system supports a variety of features, many are dependent on your cellular phone's functionality.

At a minimum, most cellular phones with Bluetooth wireless technology support the following functions:

- Answering an incoming call.
- Ending a call.
- Using privacy mode.
- Dialing a number.
- Redialing.
- Call waiting notification.
- Caller ID.

Other features, such as text messaging using Bluetooth and automatic phonebook download, are phone-dependent features. To check your phone's compatibility, see your phone's user manual and visit [www.SYNCMYride.com](http://www.SYNCMYride.com), [www.SYNCMYride.ca](http://www.SYNCMYride.ca) or [www.syncmaroute.ca](http://www.syncmaroute.ca).

## Pairing Your Phone for the First Time

### WARNING



Driving while distracted can result in loss of vehicle control, crash and injury. We strongly recommend that you use extreme caution when using any device that may take your focus off the road. Your primary responsibility is the safe operation of your vehicle. We recommend against the use of any handheld device while driving and encourage the use of voice-operated systems when possible. Make sure you are aware of all applicable local laws that may affect the use of electronic devices while driving.

The first thing you must do to use the phone features of SYNC is to pair your Bluetooth-enabled cellular phone with SYNC. This allows you to use your phone in a hands-free manner.

**Note:** *Put the transmission in position P. Turn on your vehicle ignition and the radio.*

1. Touch **Add Phone** in the upper left corner of the touchscreen. **Find SYNC** appears on the screen, and instructs you to begin the pairing process from your device.
2. Make sure that Bluetooth is set to **On** and that your cellular phone is in the proper mode. See your phone's manual if necessary.

**Note:** *Select **SYNC**, and a six-digit PIN appears on your device.*

3. If you are prompted to enter a PIN on your device, it does not support Secure Simple Pairing. To pair, enter the PIN displayed on the touchscreen. Skip the next step.
4. When prompted on your phone's display, confirm that the PIN provided by SYNC matches the PIN displayed on your cellular phone.
5. The display indicates when the pairing is successful.

SYNC may prompt you with more phone options. For more information on your phone's capability, see your phone's manual and visit the website.

## Pairing Subsequent Phones

**Note:** *Put the transmission in position P. Turn on your vehicle ignition and the radio.*

Make sure that Bluetooth is set to **On** and that your cellular phone is in the proper mode. See your device's manual if necessary. To pair a subsequent phone, press:

1. **Phone.**

# MyFord Touch™ (If Equipped)

2. **Settings.**
3. **BT Devices.**
4. **Add Device.**
5. When prompted on your phone's display, enter the six-digit PIN provided by SYNC on the screen. The display indicates when the pairing is successful.

SYNC may prompt you with more phone options. For more information on your phone's capability, see your phone's manual and visit the website.

## Making Calls



Press the voice button on the steering wheel controls. When prompted, say, "Call <name>" or say "Dial", then the desired number.



To end the call or exit phone mode, press and hold the phone button.

## Receiving Calls

During an incoming call, an audible tone sounds. Call information appears in the display if it is available.



Accept the call by pressing **Accept** on the touchscreen or by pressing the phone button on the steering wheel.



Reject the call by pressing **Reject** on the touchscreen or by pressing the phone button on the steering wheel.

Ignore the call by doing nothing. SYNC logs it as a missed call.

## Phone Menu Options

Press the top left corner on your touchscreen to select from the following options:

## Phone

Touch this button to access the on-screen numerical pad to enter a number and place a call. During an active call, you can also choose to:

- Mute the call.
- Put the call on hold.
- Turn on the privacy feature.
- Join two calls.
- End the call.

## Quick Dial

Select and call contacts stored in your phonebook contacts and call history folder.

## Phonebook

Touch this button to access and call any contacts in your previously downloaded phone book. The system places the entries in alphabetical categories summarized at the top of the screen.

To turn on contact picture settings, if your device supports this feature, press:

1. **Phone.**
2. **Settings.**
3. **Manage Phonebook.**
4. **Download photos from Phonebook.**
5. **On.**

Certain smartphones may support transferring street addresses when listed with phone book contact information. If your phone supports this feature, you can select and use these addresses as destinations and save them as favorites.

## History

After you connect your Bluetooth-enabled phone to SYNC, you can access any previously dialed, received or missed calls. You can also choose to save these to your Favorites or to Quick Dial.



# MyFord Touch™ (If Equipped)

**Note:** *This is a phone-dependent feature. If your phone does not support downloading call history using Bluetooth, SYNC keeps track of calls made with the SYNC system.*

## Messaging

Send text messages using your touchscreen. See **Text messaging** later in this section.

## Settings

Touch this button to access various phone settings, such as turning Bluetooth on and off, managing your phonebook and more. See **Phone settings** later in this section.

## Text Messaging

**Note:** *Downloading and sending text messages using Bluetooth are phone-dependent features.*

**Note:** *Certain features in text messaging are speed-dependent and not available when your vehicle is traveling at speeds over 3 mph (5 km/h).*

**Note:** *SYNC does not download read text messages from your phone.*

You can send and receive text messages using Bluetooth, read them aloud and translate text messaging acronyms, such as LOL.

1. Touch the top left corner of the display to access the **Phone** menu.

2. Select **Messaging**.
3. Choose from the following:
  - Listen (speaker icon)
  - Dial
  - Send Text
  - View
  - Delete.

## Composing a Text Message

**Note:** *This is a speed-dependent feature. It is unavailable when your vehicle is traveling at speeds over 5 mph (8 km/h).*

**Note:** *Downloading and sending text messages using Bluetooth are phone-dependent features.*

1. Press **Phone**.
2. **Messaging**.
3. **Send Text**.
4. Enter a phone number or choose from your phonebook.

You can select from the following options:

- **Send**, which sends the message as it is.
- **Edit Text**, which allows you to customize the pre-defined message or create a message on your own.

You can then preview the message, verify the recipient as well as update the message list, and send it to a connected device (such as a USB drive).

Text message options
I'll call you back in a few minutes.
I just left, I'll be there soon.
Can you give me a call?
I'm on my way.
I'm running a few minutes late.

# MyFord Touch™ (If Equipped)

Text message options
I'm ahead of schedule, so I'll be there early.
I'm outside.
I'll call you when I get there.
OK
Yes
No
Thanks
Stuck in traffic.
Call me later.
LOL

## Receiving a Text Message

**Note:** *If you select View and your vehicle is traveling over 3 mph (5 km/h), the system offers to read the message to you instead of allowing you to view it while driving.*

When a new message arrives, an audible tone sounds and the screen displays a pop-up with the caller name and ID, if supported by your phone. You can press:

- **View** to view the text message.
- **Listen** for SYNC to read the message to you.
- **Dial** to call the contact.
- **Ignore** to exit the screen.

## Phone Settings

To enter the phone settings menu press:

1. **Phone.**
2. **Settings.**
3. Choose from the following:

## Bluetooth Devices

Touch this tab to connect, disconnect, add or delete a device, as well as save it as a favorite.

### Bluetooth

Touch this tab to turn Bluetooth off or on.

### Do Not Disturb

Touch this tab if you want all calls to go directly to your voice mail and not ring in the vehicle. When this feature is on, text message notifications do not ring inside the cabin either.

### 911 Assist

Turn on or turn off the 911 Assist feature. See **Information** (page 337).

### Phone Ringer

Select the ring tone you want to hear when you receive a call. Choose from possible system ring tones, your currently paired phone's ring tone, a beep, text-to-speech or a silent notification.

# MyFord Touch™ (If Equipped)

## Text Message Notification

Select a text message notification, if supported by your phone. Choose from possible system alert tones, text-to-speech or silent.

## Internet Data Connection

If your phone is compatible, use this screen to adjust your internet data connection. Select to make your connection profile with the personal area network or to turn off your connection. You can also choose to adjust your settings or have the system always connect, never connect when roaming or query on connect. Press ? for more information.

## Manage Phonebook

Touch this button to access features such as automatic phonebook download, re-download your phonebook, add contacts from your phone as well as delete or upload your phonebook.

## Roaming Warning

Touch this button to have the system alert you when your phone is in roaming mode.

## Phone Voice Commands



Press the voice button on the steering wheel controls. When prompted, say any of the following commands:

"PHONE"	
"Call"	"Join calls" <sup>1</sup>
"Call <name>"	"Listen to text message <#>"
"Call <name> at home"	"Listen to text messages"
"Call <name> at work"	"Messages" <sup>2</sup>
"Call <name> on cell"	"Mute call" <sup>1</sup>
"Call <name> on other"	"Pair phone"
"Call voicemail"	"Privacy on" <sup>1</sup>
"Dial"	"Read text message"
"Do not disturb off"	"Reply to text messages"
"Do not disturb on"	"Turn ringer off"
"Forward text messages"	"Turn ringer on"
"Go to hands free" <sup>1</sup>	"Unmute call" <sup>1</sup>

## MyFord Touch™ (If Equipped)

"PHONE"	
"Hold call off" <sup>1</sup>	"Help"
"Hold on" <sup>1</sup>	

<sup>1</sup> These commands are only available during an active call.

<sup>2</sup> If you say "Messages", see the following "Messages" chart for additional commands.

"MESSAGES"
"Call"
"Forward text messages"
"Listen to text message <#>"
"Listen to text messages"
"Reply to text messages"
"Help"

## INFORMATION



E161889

## MyFord Touch™ (If Equipped)

- A SYNC Services
- B SIRIUS Travel Link
- C Alerts
- D Calendar
- E SYNC Applications

Under the Information menu, you can access features such as:

- SYNC Services
- SIRIUS Travel Link
- Alerts
- Calendar
- SYNC Applications



If your vehicle is equipped with Navigation, press the **Information** button to access these features. If your vehicle is not equipped with Navigation, press the corner of the touchscreen with the green tab.

### **SYNC Services (If Equipped, United States Only)**

**Note:** SYNC Services requires activation before use. Visit [www.SYNCMyRide.com](http://www.SYNCMyRide.com) to register and check your eligibility for complimentary services. Standard phone and message rates may apply. Subscription may be required. You must also have the active SYNC Services Bluetooth-enabled cellular phone paired and connected to the system in order to connect to, and use, SYNC Services. See **Phone** (page 331).

**Note:** This feature does not function properly if you have enabled caller ID blocking on your cellular phone. Make sure your cellular phone is not blocking caller ID before using SYNC Services.

**Note:** The driver is ultimately responsible for the safe operation of the vehicle, and therefore, must evaluate whether it is safe to follow the suggested directions. Any navigation features provided are only an aid. Make your driving decisions based on your observations of local conditions and existing traffic regulations. Do not follow the route suggestions if doing so would result in an unsafe or illegal maneuver, if you would be placed in an unsafe situation, or if you would be directed into an area that you consider unsafe. Maps used by this system may be inaccurate because of errors, changes in roads, traffic conditions or driving conditions.

**Note:** When you connect, the service uses GPS technology and advanced vehicle sensors to collect your vehicle's current location, travel direction and speed to help provide you with the directions, traffic reports, or business searches you request. Further, to provide the services you request, for continuous improvement, the service may collect and record call details and voice communications. For more information, see SYNC Services Terms and Conditions at [www.SYNCMyRide.com](http://www.SYNCMyRide.com). If you do not want Ford or its service providers to collect your vehicle travel information or other information identified in the Terms and Conditions, do not subscribe or use the service.

# MyFord Touch™ (If Equipped)

SYNC Services uses advanced vehicle sensors, integrated GPS technology and comprehensive map and traffic data, to give you personalized traffic reports, precise turn-by-turn directions, business search, news, sports, weather and more. For a complete list of services, or to learn more, please visit [www.SYNCMyRide.com](http://www.SYNCMyRide.com).

## Connecting to SYNC Services Using Voice Commands



1. Press the voice button.
2. When prompted, say "Services". This initiates an outgoing call to SYNC Services using your paired and connected Bluetooth-enabled cellular phone.
3. Once you connect to the service, follow the voice prompts to request the desired service, such as "Traffic" or "Directions". You can also say, "What are my choices?" to receive a list of available services from which to choose.
4. Say, "Services" to return to the Services main menu or for help, say, "Help".

## Connecting to SYNC Services Using the Touchscreen



If your vehicle is equipped with Navigation, press the **Information** button.

If your vehicle is not equipped with Navigation, press the green tab on your touchscreen.

1. Select **Connect to Services** to initiate an outgoing call to SYNC Services using your phone.

2. Once connected, follow the voice prompts to request your desired Service, such as "Traffic" or "Directions". You can also say, "What are my choices?" to receive a list of available services from which to choose.
3. Say, "Services" to return to the Services main menu or for help, say, "Help".

## Receiving Turn-by-Turn Directions

1. When connected to SYNC Services, say "Directions" or "Business search". To find the closest business or type of business to your current location, just say "Business search" and then "Search near me". If you need further assistance in finding a location you can say "Operator" at any time within a Directions or Business search to speak with a live operator. The system may prompt you to speak with an operator when it has difficulty matching your voice request. The live operator can assist you by searching for businesses by name or by category, residential addresses by street address or by name or specific street intersections. Operator Assist is a feature of your SYNC Services subscription. For more information on Operator Assist, visit [www.SYNCMyRide.com/support](http://www.SYNCMyRide.com/support).
2. Follow the voice prompts to select your Destination. After the route download is finished, the phone call automatically ends.

# MyFord Touch™ (If Equipped)

If your vehicle is not equipped with Navigation:

- Turn-by-turn directions appear in the information display, in the status bar of your touchscreen system and on the SYNC Services screen. You also receive driving instructions from audible prompts.
- When on an active route, you can select **Route Summary** or **Route Status** using the touchscreen controls or voice commands to view the **Route Summary Turn List** or the **Route Status ETA**. You can also turn voice guidance on or off, cancel the route or update the route.

If you miss a turn, SYNC automatically asks if you want the route updated. Just say, "Yes" when prompted and the system delivers a new route to your vehicle.

If your vehicle is equipped with Navigation, SYNC Services downloads your requested destination to the navigation system. The navigation system then calculates the route and provides driving instructions. See **Navigation** (page 346).

## Disconnecting from SYNC Services

1. Press and hold the hang-up phone button on the steering wheel.
2. Say "Good-bye" from the SYNC Services main menu.

SYNC Services quick tips	
Personalizing	You can personalize your Services feature to provide quicker access to your most used or favorite information. You can save address points, such as work or home. You can also save favorite information like sports teams, such as Detroit Lions, or a news category. You can learn more about personalization by logging onto <a href="http://www.SYNCMYride.com">www.SYNCMYride.com</a> .
Push to interrupt	Press the voice button at any time (while connected to SYNC Services) to interrupt a voice prompt or an audio clip (such as a sports report) and say your voice command.
Portable	Your subscription is associated with your Bluetooth-enabled cellular phone number, not your VIN (Vehicle Identification Number). You can pair and connect your phone to any vehicle equipped with SYNC Services and continue enjoying your personalized services.

## SYNC Services Voice Commands



When a route has been downloaded (non-navigation systems), press the voice button on the steering wheel controls. When prompted, say any of the following commands:

<b>"SERVICES"</b>
"Cancel route"
"Navigation voice off"
"Navigation voice on"
"Next turn"

## MyFord Touch™ (If Equipped)

<b>"SERVICES"</b>
"Route status"
"Route summary"
"Services"
"Update route"
"Help"

### SIRIUS Travel Link (If Equipped)

#### WARNING



Driving while distracted can result in loss of vehicle control, crash and injury. We strongly recommend that you use extreme caution when using any device that may take your focus off the road. Your primary responsibility is the safe operation of your vehicle. We recommend against the use of any handheld device while driving and encourage the use of voice-operated systems when possible. Make sure you are aware of all applicable local laws that may affect the use of electronic devices while driving.

**Note:** In order to use SIRIUS Travel Link, your vehicle must be equipped with navigation and your navigation SD card must be in the SD card slot.

**Note:** A paid subscription is required to access and use these features. Go to [www.siriusxm.com/travellink](http://www.siriusxm.com/travellink) for more information.

**Note:** Visit [www.siriusxm.com/traffic#](http://www.siriusxm.com/traffic#) and click on Coverage map and details for a complete listing of all traffic areas covered by SIRIUS Travel Link.

**Note:** Neither SIRIUS nor Ford is responsible for any errors or inaccuracies in the SIRIUS Travel Link services or its use in vehicles.

When you subscribe to SIRIUS Travel Link, it can help you locate the best gas prices, find movie listings, get current traffic alerts, view the current weather map, get accurate ski conditions and see scores to current sports games.



If your vehicle is equipped with Navigation, touch the i (Information) button to access these features. If your vehicle is not equipped with Navigation, touch the corner of the touchscreen with the green tab.

### Traffic On Route and Traffic Nearby

Touch these buttons to identify traffic incidents on your route, nearby your vehicle's current location or near any of your favorite places, if programmed.

### Fuel Prices

Touch this button to view fuel prices at stations close to your vehicle's location or on an active navigation route.

### Movie Listings

Touch this button to view nearby movie theaters and their show times, if available.

### Weather

Touch this button to view the nearby weather, current weather, or the five day forecast for the chosen area. Select **Map** to see the weather map, which can show storms, radar information, charts and winds. Select **Area** to select from a listing of weather locations.

### Sports Info

Touch this button to view scores and schedules from a variety of sports. You can also save up to 10 favorite teams for easier access. The score automatically refreshes when a game is in progress.



# MyFord Touch™ (If Equipped)

## Ski Conditions

Touch this button to view ski conditions for a specific area.

## SIRIUS Travel Link Voice Commands



Press the voice button on the steering wheel controls. When prompted, say any of the following commands:

"SIRIUS TRAVEL LINK"
"5-day weather forecast"
"Fuel prices"
"Movie listings"
"Sports headlines"*
"Sports schedules"*
"Sports scores"*
"Traffic"
"Weather"
"Weather map"
"Help"

\* If you say "Sports headlines", "Sports schedules" or "Sports scores", you can then say any of the commands in the following chart.

Sports-related commands
"Baseball"
"College basketball"
"College football"
"Golf"
"MLS"

Sports-related commands
"My teams"
"NBA"
"NFL"
"NHL"
"WNBA"
"Help"

Additional sports-related voice commands
"Baseball headlines"
"Baseball schedule"
"Baseball scores"
"College basketball headlines"
"College basketball schedule"
"College basketball scores"
"College football headlines"
"College football schedule"
"College football scores"
"Golf headlines"
"Golf leaderboard"
"Golf schedule"
"MLS headlines"
"MLS schedule"
"MLS scores"
"Motor sports headlines"
"Motor sports order"
"Motor sports schedule"
"My team headlines"

## MyFord Touch™ (If Equipped)

### Additional sports-related voice commands

"My teams schedule"
"My teams scores"
"NBA headlines"
"NBA schedule"
"NBA scores"
"NFL headlines"
"NFL schedule"
"NFL scores"
"NHL headlines"
"NHL schedule"
"NHL scores"
"WNBA headlines"
"WNBA schedule"
"WNBA scores"
"Help"

### Alerts

 If your vehicle is equipped with Navigation, touch the **i** (Information) button to access these features. If your vehicle is not equipped with Navigation, touch the corner of the touchscreen with the green tab.

Press **Alerts**, and then choose from any of the following services:

- **View** the complete message.
- **Delete** the message.
- **Delete All** messages.

This screen displays any system messages (such as an SD card fault).

**Note:** The system alerts you to any messages by turning the information icon yellow. After you read or delete the messages, the icon returns to white.

### Calendar

 If your vehicle is equipped with Navigation, touch the **i** (Information) button to access these features. If your vehicle is not equipped with Navigation, touch the corner of the touchscreen with the green tab.

Press **Calendar**. You can view the current calendar by day, week or month.

### 911 Assist (If Equipped)

#### WARNINGS



Unless the 911 Assist setting is set on before a crash, the system will not dial for help, which could delay response time, potentially increasing the risk of serious injury or death after a crash.



Do not wait for 911 Assist to make an emergency call if you can do it yourself. Dial emergency services immediately to avoid delayed response time, which could increase the risk of serious injury or death after a crash. If you do not hear 911 Assist within five seconds of the crash, the system or phone may be damaged or non-functional.



Always place your phone in a secure location in your vehicle so it does not become a projectile or damaged in a crash. Failure to do so may cause serious injury to someone or damage the phone, which could prevent 911 Assist from working properly.

**Note:** The SYNC 911 Assist feature must be set on prior to the incident.

## MyFord Touch™ (If Equipped)

**Note:** Before setting this feature on, make sure that you read the 911 Assist Privacy Notice later in this section for important information.

**Note:** If any user turns 911 Assist on or off, that setting applies for all paired phones. If 911 Assist is turned off, either a voice message plays or a display message (or icon) comes on (or both) when your vehicle is started after a previously paired phone connects.

**Note:** Every phone operates differently. While SYNC 911 Assist works with most cellular phones, some may have trouble using this feature.

If a crash deploys an airbag (excludes knee airbags and rear inflatable safety belts [if equipped]) or activates the fuel pump shut-off, your SYNC-equipped vehicle may be able to contact emergency services by dialing 911 through a paired and connected Bluetooth-enabled phone. You can learn more about the 911 Assist feature, visit [www.SYNCMyRide.com](http://www.SYNCMyRide.com), [www.SYNCMyRide.ca](http://www.SYNCMyRide.ca) or [www.syncmaroute.ca](http://www.syncmaroute.ca).

See **Supplementary Restraints System** (page 34). Important information regarding airbag deployment is in this chapter.

See **Roadside Emergencies** (page 166). Important information regarding the fuel pump shut-off is in this chapter.

### Setting 911 Assist On



If your vehicle is equipped with Navigation, touch the i (Information) button to access these features. If your vehicle is not equipped with Navigation, touch the corner of the touchscreen with the green tab.

Touch **Apps > 911 Assist**, then select **On**.



You can also access 911 Assist by:

- Pressing the Settings icon > **Settings > Phone > 911 Assist**, or
- Pressing the Settings icon > **Help > 911 Assist**.

To make sure that 911 Assist works properly:

- SYNC must be powered and working properly at the time of the incident and throughout feature activation and use.
- The 911 Assist feature must be set on prior to the incident.
- You must pair and connect a Bluetooth-enabled and compatible phone to SYNC.
- A connected Bluetooth-enabled phone must have the ability to make and maintain an outgoing call at the time of the incident.
- A connected Bluetooth-enabled phone must have adequate network coverage, battery power and signal strength.
- The vehicle must have battery power and be located in the United States, Canada or in a territory in which 911 is the emergency number.

### In the Event of a Crash

Not all crashes deploy an airbag or activate the fuel pump shut-off (which would trigger 911 Assist); however, SYNC tries to contact emergency services if 911 Assist triggers. If a connected phone sustains damage or loses connection to SYNC, SYNC searches for, and tries to connect to, any available previously paired phone and tries to make the call to 911.

Before making the call:

- SYNC provides a short window of time (about 10 seconds) to cancel the call. If you fail to cancel the call, SYNC attempts to dial 911.
- SYNC says the following, or a similar message: "SYNC will attempt to call 911, to cancel the call, press Cancel on your screen or press and hold the phone button on your steering wheel."

If you do not cancel the call, and SYNC makes a successful call, a pre-recorded message plays for the 911 operator, and then the occupant(s) in your vehicle is able to talk with the operator. Be prepared to provide your name, phone number and location immediately, because not all 911 systems are capable of receiving this information electronically.

## 911 Assist May Not Work If

- Your cellular phone or 911 Assist hardware sustains damage in a crash.
- The vehicle's battery or the SYNC system has no power.
- The phone(s) thrown from your vehicle are the ones paired and connected to the system.

## 911 Assist Privacy Notice

When you turn on 911 Assist, it may disclose to emergency services that your vehicle has been in a crash involving the deployment of an airbag or activation of the fuel pump shut-off. Certain versions or updates to 911 Assist may also be capable of electronically or verbally disclosing to 911 operators your vehicle location or other details about your vehicle or crash to assist 911 operators to provide the most appropriate emergency services. If you do not want to disclose this information, do not turn the feature on.

## Vehicle Health Report (If Equipped)

### WARNING



Always follow scheduled maintenance instructions, regularly inspect your vehicle, and seek repair for any damage or problem you suspect. Vehicle Health Report supplements, but cannot replace, normal maintenance and vehicle inspection. Vehicle Health Report only monitors certain systems electronically monitored by your vehicle and will not monitor or report the status of any other system, (such as brake lining wear). Failure to perform scheduled maintenance and regularly inspect your vehicle may result in vehicle damage and serious injury.

**Note:** This feature is only available in the United States.

**Note:** Your Vehicle Health Report feature requires activation prior to use. Visit [www.SYNCMYride.com](http://www.SYNCMYride.com) to register. There is no fee or subscription associated with Vehicle Health Report, but you must register to use this feature.

**Note:** This feature may not function properly if you have enabled caller ID blocking on your cellular phone. Before running a report, review the Vehicle Health Report Privacy Notice.

**Note:** In order to allow a break-in period for your vehicle, you may not be able to create a Vehicle Health Report until your vehicle odometer has reached 200 miles.

**Note:** Cellular phone and SMS charges may apply when making a report.

## MyFord Touch™ (If Equipped)

Register for Vehicle Health Report and set your report preferences at [www.SYNCMYRide.com](http://www.SYNCMYRide.com). After registering, you can request a Vehicle Health Report (inside your vehicle). Return to your account at [www.SYNCMYRide.com](http://www.SYNCMYRide.com) to view your report. You can also choose for SYNC to remind you automatically to run reports at specific mileage intervals. Cellular phone airtime usage may apply when reporting.

The system allows you to check your vehicle's overall health in the form of a diagnostic report card. The Vehicle Health Report contains valuable information, such as:

- Vehicle diagnostic information
- Scheduled maintenance
- Open recalls and Field Service Actions
- Items noted during vehicle inspections by your authorized dealer that still need servicing.

### Making a Report



If you want to run a report by using the touchscreen, touch **Apps > Vehicle Health Report**.



To run a report by voice command, press the voice button on the steering wheel and, when prompted, say "Vehicle health report".

### Vehicle Health Report Privacy Notice

When you create a Vehicle Health Report, Ford Motor Company may collect your cellular phone number (to process your report request) and diagnostic information about your vehicle. Certain versions or updates to Vehicle Health Report may also collect more vehicle information. Ford may

use your vehicle information it collects for any purpose. If you do not want to disclose your cellular phone number or vehicle information, do not run the feature or set up your Vehicle Health Report profile at [www.SYNCMYRide.com](http://www.SYNCMYRide.com). See [www.SYNCMYRide.com](http://www.SYNCMYRide.com) (Vehicle Health Report Terms and Conditions, and Privacy Statement) for more information.

### NAVIGATION

**Note:** *The navigation SD card must be in the SD card slot to operate the navigation system. If you need a replacement SD card, see an authorized dealer.*

**Note:** *The SD card slot is spring-loaded. To remove the SD card, just push the card in and release it. Do not attempt to pull the card out to remove it; this could cause damage.*

For SD card slot location: See **Entertainment** (page 313).

Your navigation system is comprised of two main features, destination mode and map mode.

To set a destination, press the green corner of your touchscreen, then the **Dest** button when it appears. See **Setting a destination** later in this chapter.

To view the navigation map and your vehicle's current location, touch the green bar in the upper right hand corner of the touchscreen, or, press **Dest**, then **Map**. See **Map mode** later in this chapter.

### Setting a Destination

Press the green corner of your touchscreen, then the **Dest** button when it appears. Choose any of the following:

## MyFord Touch™ (If Equipped)

Destination	
My Home	Street Address
Favorites	Intersection
Previous Destinations	City Center
Point of Interest (POI)	Map
Emergency	Edit Route Cancel Route

1. Enter the necessary information into the highlighted text fields (in any order). For address destination entry, the **Go!** button appears once all the necessary information has been entered. Pressing the **Go!** button makes the address location appear on the map. If you choose **Previous Destination**, the last 20 destinations you have selected appear.
2. Select **Set as Dest** to make this your destination. You can also choose to set this as a waypoint (have the system route to this point on the way to your current destination) or save it as a favorite. The system considers any **Avoid Areas** selections in its route calculation.
3. Choose from up to three different types of routes, and then select **Start Route**.
  - Fastest: Uses the fastest moving roads possible.
  - Shortest: Uses the shortest distance possible.
  - Eco Route: Uses the most fuel-efficient route.

You can cancel the route or have the system demo the route for you. Select **Route Prefs** to set route preferences like avoiding freeways, tollroads, ferries and car trains as well as to use or not use high-occupancy vehicle lanes. (High-occupancy vehicle lanes also known as carpool or diamond lanes. People who ride in buses, vanpools or carpools use these lanes.)

**Note:** *If your vehicle is on a recognized road and you do not press the **Start Route** button, the system defaults to the Fastest Route option and begins guidance.*

During route guidance, you can press the talking bubble icon that appears in the upper right navigation corner (green bar) if you want the system to repeat route guidance information. When the system repeats the last guidance instruction, it updates the distance to the next guidance instruction, since it detects when the vehicle is moving.

# MyFord Touch™ (If Equipped)

## Point of Interest (POI) Categories

Main Categories	
Food/Drink & Dining	Automotive
Travel & Transportation	Shopping
Financial	Entertainment & Arts
Emergency	Recreation & Sports
Community	Government
Health & Medicine	Domestic Services

Subcategories
Restaurant
Golf
Parking
Home & Garden
Personal Care Services
Auto Dealership
Government Office
Public Transit
Education

To expand these listings, press the + in front of the listing.

When programming a point of interest destination, the system allows you to sort the resulting lists alphabetically, by distance or by cityseekr listings (if available).

Pressing the **Search Area** button allows you to search for points of interest nearby, near a city or state or near a destination, if a route is active.

Pressing the **Search By Name** button allows you to directly enter the point of interest name into the system by using the keyboard.

### cityseekr

**Note:** *cityseekr point of interest information is limited to approximately 912 cities (881 in the U.S., 20 in Canada and 11 in Mexico).*



E142634

cityseekr, when available, is a service that provides more information about certain points of interest such as restaurants, hotels and attractions.

When you have selected a point of interest, the location and information appear, such as address and phone number. If cityseekr lists the point of interest, more information is available, such as a brief description, hotel check-in and checkout times or restaurant hours.

Press **More Information** for a longer review, a list of services and facilities, the average room or meal price as well as the website link.

This screen displays either a facility photo (if available) or point of interest icons, such as:



Hotel



Coffeehouse



Food & Drink



Nightlife



Attraction



This icon appears when your selection exists in multiple categories within the system.

When you are viewing more information for hotels, cityseekr also tells you if the hotel has certain services and facilities using icons.

For restaurants, cityseekr can provide information such as star rating, average cost, review, handicap access, hours of operation, and website address.

For hotels, cityseekr can provide information such as star rating, price category, review, check in/out times, hotel service icons and website address.

## Setting Your Navigation Preferences

Select settings for the system to take into account when planning your route.



To access, press:

1. **Settings** icon.
2. **Settings**.
3. **Navigation**.

## Map Preferences

### Breadcrumbs

Display your vehicle's previously traveled route with white dots. Turn this feature **ON** or **OFF**.

### Turn List Format

Have the system display your turn list **Top to Bottom** or **Bottom to Top**.



## **Parking POI Notification**

Set the automatic parking points of interest notification. Turn this feature **ON** or **OFF**. When parking points of interest notification is on, the icons display on the map when you get close to your destination. This may not be very useful in dense areas, and may clutter the map when other points of interest display.

## **Route Preferences**

### **Preferred Route**

Choose to have the system display the Shortest, Fastest or most Ecological route.

### **Always Use Preferred Route**

Bypass route selection in destination programming. The system only calculates one route based on preferred route settings.

### **Eco Time Penalty**

Select a low, medium or high cost for the calculated Eco Route. The higher the setting, the longer the time allotment is for the route.

### **Avoid**

These features allow you to choose to have the system avoid freeways, toll roads, ferries and car trains when planning your route. Turn these features ON or OFF.

### **Use HOV Lanes**

Have the system use high-occupancy vehicle lanes, if available, when planning your route.

## **Navigation Preferences**

### **Guidance Prompts**

Have the system use **Voice & Tones** or **Tone Only** on your programmed route.

## **Auto - Fill State/Province**

Have the system automatically fill in the state and province based on the information already entered into the system. Turn this feature **ON** or **OFF**.

## **Traffic Preferences**

### **Avoid Traffic Problems**

Choose how you want the system to handle traffic problems along your route.

- **Automatic:** Have the system reroute you to avoid traffic incidents that develop and impact the current route. The system does not provide a traffic alert notification.
- **Manual:** Have the system always provide a traffic alert notification for traffic incidents along the planned route. You have a choice to accept or ignore the notification before making the route deviation.

### **Traffic Alert Notification**

Have the system display traffic alert notifications.

Other traffic alert features allows you to turn on certain, or all, traffic icons on the map such as road work, incident, accidents and closed roads. Scroll down to view all the different types of alerts. Turn these features **ON** or **OFF**.

### **Avoid Areas**

Choose areas which you want the system to avoid when calculating a route for you.

Press **Add** to program an entry. Once you make a selection, the system tries to avoid the area(s) if possible for all routes. To delete a selection, choose the listing on the screen. When the screen changes to **Avoid Areas Edit**, you can press **Delete** at the bottom right of the screen.

## Map Mode

Press the green bar in the upper right area of the touchscreen to view map mode. Map mode shows advanced viewing comprised of both 2D city maps as well as 3D landmarks (when available).

2D city maps show detailed outlines of buildings, visible land use and land elements and detailed railway infrastructure for the most essential cities around the globe. These maps also contain features, such as town blocks, building footprints, and railways.

3D landmarks appear as clear, visible objects that are typically recognizable and have a certain tourist value. The 3D landmarks appear in 3D map mode only. Coverage varies, and improves with updated map releases.



E162051

Change the appearance of the map display by repeatedly pressing the arrow button in the upper left corner of the screen. It toggles between three different map modes: Heading up, North up, and 3D.



**Heading up (2D map)** always shows the direction of forward travel to be upward on the screen.

This view is available for map scales up to 2.5 miles (4 kilometers). The system remembers this setting for larger map scales, but shows the map in North up only. If the scale returns below this level, the system restores Heading up.



**North up (2D map)** always shows the northern direction to be upward on the screen.



**3D map mode** provides an elevated perspective of the map. This viewing angle can be adjusted and the map can be rotated 180 degrees by touching the map twice, and then dragging your finger along the shaded bar with arrows at the bottom of the map.

**View** toggles between full map, street list and exit view in route guidance.

**Menu** allows access to navigation settings, view or edit route, SIRIUS Travel Link, guidance mute and cancel route.



**Re-centering the map** by pressing this icon whenever you scroll the map away from your vehicle's current location.

## Auto Zoom

Press the green bar to access map mode, then select the + or - zoom button to bring up the zoom level and Auto buttons on the touchscreen. When you press **Auto**, Auto Zoom turns on and Auto displays in the bottom left corner of the screen in the map scale. The map zoom level then synchronizes with vehicle speed. The slower your vehicle is traveling, the farther in the map zooms; the faster your vehicle is traveling, the farther the map zooms out. To turn the feature off, just press the + or - button again.

In 3D mode, rotate the map view by swiping your finger across the shaded bar with the arrows.

## Map Icons



**Vehicle mark** shows the current location of your vehicle. It stays in the center of the map display, except when in scroll mode.



**Scroll cursor** allows you to scroll the map; the fixed icon is in the center of the screen. The map position closest to the cursor is in a window on the top center part of the screen.



**Address book entry default icon(s)** indicates the location on the map of an address book entry. This is the default symbol shown after the entry has been stored to the Address Book by any method other than the map. You can select from any of the 22 icons available. You can use each icon more than once.



**Home** indicates the location on the map currently stored as the home position. You can only save one address from the Address Book as your Home entry. You cannot change this icon.



**POI (Point Of Interest) icons** indicate locations of any point of interest categories you choose to display on the map. You can choose to display three point of interest categories on the map at one time.



**Starting point** indicates the starting point of a planned route.



**Waypoint** indicates the location of a waypoint on the map. The number inside the circle is different for each waypoint and represents the position of the waypoint in the route list.



**Destination symbol** indicates the ending point of a planned route.



**Next maneuver point** indicates the location of the next turn on the planned route.



**No GPS symbol** indicates that insufficient GPS satellite signals are available for accurate map positioning. This icon may display under normal operation in an area with poor GPS access.

## Quick-touch Buttons

When in map mode, touch anywhere on the map display to access the following options:

### Set as Dest

Touch this button to select a scrolled location on the map as your destination. You may scroll the map by pressing your index finger on the map display. When you reach the desired location, simply let go and then touch **Set as Dest**.

### Set as Waypoint

Touch this button to set the current location as a waypoint.

### Save to Favorites

Touch this button to save the current location to your favorites.

### POI Icons

Touch this button to select icons to display on the map. You can select up to three icons to display on the map at the same time. Turn these **ON** or **OFF**.

### Cancel Route

Touch this button to cancel the active route.

### View/Edit Route

Access these features when a route is active:

- View Route
- Edit Destination/Waypoints

# MyFord Touch™ (If Equipped)

- Edit Turn List
- Detour
- Edit Route Preferences
- Edit Traffic Preferences
- Cancel Route.

Navteq is the digital map provider for the navigation application. If you find map data errors, you may report them directly to Navteq by going to <http://mapreporter.navteq.com>. Navteq evaluates all reported map errors and responds with the result of their investigation by e-mail.

## Navigation Map Updates

Annual navigation map updates are available for purchase through your dealership, by calling 1-800-NAVMAPS (in Mexico, call 01-800-557-5539) or going to [www.navigation.com/ford](http://www.navigation.com/ford). You need to specify the make and model of your vehicle to determine if there is an update available.

## Navigation Voice Commands



When in navigation mode, press the voice button on the steering wheel controls. After the tone, say any of the following commands:

### Navigation System Voice Commands

"Cancel next waypoint" <sup>1</sup>	"Navigation" <sup>3</sup>
"Cancel route" <sup>1</sup>	"Repeat instruction" <sup>1</sup>
"Destination" <sup>2</sup>	"Show 3D"
"Destination <nametag>"	"Show heading up"
"Destination <POI category>"	"Show map"
"Destination favorites"	"Show north up"
"Destination home"	"Show route" <sup>1</sup>
"Destination intersection"	"Show turn list" <sup>1</sup>
"Destination nearest <POI category>"	"Voice off"
"Destination nearest POI"	"Voice on"
"Destination play nametags"	"Voice volume decrease"
"Destination POI"	"Voice volume increase"
"Destination POI category"	"Where am I?"
"Destination previous destination"	"Zoom in"

## MyFord Touch™ (If Equipped)

Navigation System Voice Commands	
"Destination street address"	"Zoom out"
"Detour" <sup>1</sup>	"Help"

<sup>1</sup> These commands are only available when a navigation route is active.

<sup>2</sup> If you say "Destination", you can then say any command in the following "Destination" chart.

<sup>3</sup> If you say "Navigation", you can then say any command in the following "Navigation" chart.

"DESTINATION"
"<nametag>"
"<POI category>"
"Favorites"
"Home"
"Intersection"
"Nearest <POI category>"
"Nearest POI"
"Play nametags"
"POI category"
"Previous destination"
"Street address"
"Help"

"NAVIGATION"
"Destination"*
"Zoom city"
"Zoom country"
"Zoom minimum"

## MyFord Touch™ (If Equipped)

---

<b>"NAVIGATION"</b>
"Zoom maximum"
"Zoom province"
"Zoom state"
"Zoom street"
"Zoom to <distance>"
"Help"

\* If you say "Destination", you can then say any command in the "Destination" chart.

### **One-shot Destination Street Address**

If your vehicle is equipped with the SD card navigation feature, you have the ability to enter in a street address using a feature called one-shot street address. When you say either "Navigation destination street address" or "Destination street address", the system asks you to say the full address. The system displays an example on-screen. You can then speak the address naturally, such as "One two three four Main Street, Anytown".

# Appendices

---

## END USER LICENSE AGREEMENT

### SYNC® End User License Agreement (EULA)

- You have acquired a device ("DEVICE") that includes software licensed by Ford Motor Company and its affiliates ("FORD MOTOR COMPANY") from an affiliate of Microsoft Corporation ("MS"). Those installed software products of MS origin, as well as associated media, printed materials, and "online" or electronic documentation ("MS SOFTWARE") are protected by international intellectual property laws and treaties. The MS SOFTWARE is licensed, not sold. All rights reserved.
- The MS SOFTWARE may interface with and/or communicate with, or may be later upgraded to interface with and/or communicate with additional software and/or systems provided by FORD MOTOR COMPANY. The additional software and systems of FORD MOTOR COMPANY origin, as well as associated media, printed materials, and "online" or electronic documentation ("FORD SOFTWARE") are protected by international intellectual property laws and treaties. The FORD SOFTWARE is licensed, not sold. All rights reserved.

- The MS SOFTWARE and/or FORD SOFTWARE may interface with and/or communicate with, or may be later upgraded to interface with and/or communicate with additional software and/or systems provided by third party software and service suppliers. The additional software and services of third party origin, as well as associated media, printed materials, and "online" or electronic documentation ("THIRD PARTY SOFTWARE") are protected by international intellectual property laws and treaties. The THIRD PARTY SOFTWARE is licensed, not sold. All rights reserved.
- The MS SOFTWARE, FORD SOFTWARE and THIRD PARTY SOFTWARE hereinafter collectively and individually will be referred to as "SOFTWARE".

**IF YOU DO NOT AGREE TO THIS END USER LICENSE AGREEMENT ("EULA") DO NOT USE THE DEVICE OR COPY THE SOFTWARE. ANY USE OF THE SOFTWARE, INCLUDING BUT NOT LIMITED TO USE ON THE DEVICE, WILL CONSTITUTE YOUR AGREEMENT TO THIS EULA (OR RATIFICATION OF ANY PREVIOUS CONSENT).**

**GRANT OF SOFTWARE LICENSE:** This EULA grants you the following license:

- You may use the SOFTWARE as installed on the DEVICE and as otherwise interfacing with systems and/or services provide by or through FORD MOTOR COMPANY or its third party software and service providers.

# Appendices

---

## Description of Other Rights and Limitations

- **Speech Recognition:** If the SOFTWARE includes speech recognition component(s), you should understand that speech recognition is an inherently statistical process and that recognition errors are inherent in the process. Neither FORD MOTOR COMPANY nor its suppliers shall be liable for any damages arising out of errors in the speech recognition process.
- **Limitations on Reverse Engineering, Decompilation and Disassembly:** You may not reverse engineer, decompile, or disassemble nor permit others to reverse engineer, decompile or disassemble the SOFTWARE, except and only to the extent that such activity is expressly permitted by applicable law notwithstanding this limitation.
- **Limitations on Distributing, Copying, Modifying and Creating Derivative Works:** You may not distribute, copy, make modifications to or create derivative works based on the SOFTWARE, except and only to the extent that such activity is expressly permitted by applicable law notwithstanding this limitation.
- **Single EULA:** The end user documentation for the DEVICE and related systems and services may contain multiple EULAs, such as multiple translations and/or multiple media versions (e.g., in the user documentation and in the software). Even if you receive multiple EULAs, you are licensed to use only one (1) copy of the SOFTWARE.
- **SOFTWARE Transfer:** You may permanently transfer your rights under this EULA only as part of a sale or transfer of the DEVICE, provided you retain no copies, you transfer all of the SOFTWARE (including all component parts, the media and printed materials, any upgrades, and, if applicable, the Certificate(s) of Authenticity), and the recipient agrees to the terms of this EULA. If the SOFTWARE is an upgrade, any transfer must include all prior versions of the SOFTWARE.
- **Termination:** Without prejudice to any other rights, FORD MOTOR COMPANY or MS may terminate this EULA if you fail to comply with the terms and conditions of this EULA.
- **Security Updates/Digital Rights Management:** Content owners use the WMDRM technology included in your DEVICE to protect their intellectual property, included copyrighted content. Portions of the SOFTWARE on your DEVICE use WMDRM software to access WMDRM-protected content. If the WMDRM software fails to protect the content, content owners may ask Microsoft to revoke the SOFTWARE's ability to use WMDRM to play or copy protected content. This action does not affect unprotected content. When your DEVICE downloads licenses for protected content, you agree that Microsoft may include a revocation list with the licenses. Content owners may require you to upgrade the SOFTWARE on your DEVICE to access their content. If you decline an upgrade, you will not be able to access content that requires the upgrade.



# Appendices

---

- **Consent to Use of Data:** You agree that MS, Microsoft Corporation, FORD MOTOR COMPANY, third party software and systems suppliers, their affiliates and/or their designated agent may collect and use technical information gathered in any manner as part of product support services related to the SOFTWARE or related services. MS, Microsoft Corporation, FORD MOTOR COMPANY, third party software and services suppliers, their affiliates and/or their designated agent may use this information solely to improve their products or to provide customized services or technologies to you. MS, Microsoft Corporation, FORD MOTOR COMPANY, third party software and systems suppliers, their affiliates and/or their designated agent may disclose this information to others, but not in a form that personally identifies you.

- **Internet-Based Services Components:** The SOFTWARE may contain components that enable and facilitate the use of certain Internet-based services. You acknowledge and agree that MS, Microsoft Corporation, FORD MOTOR COMPANY, third party software and service suppliers, their affiliates and/or their designated agent may automatically check the version of the SOFTWARE and/or its components that you are utilizing and may provide upgrades or supplements to the SOFTWARE that may be automatically downloaded to your DEVICE.

- **Additional Software/Services:** The SOFTWARE may permit FORD MOTOR COMPANY, third party software and service suppliers, MS, Microsoft Corporation, their affiliates and/or their designated agent to provide or make available to you SOFTWARE updates,

supplements, add-on components, or Internet-based services components of the SOFTWARE after the date you obtain your initial copy of the SOFTWARE ("Supplemental Components").

If FORD MOTOR COMPANY or third party software and services suppliers provide or make available to you Supplemental Components and no other EULA terms are provided along with the Supplemental Components, then the terms of this EULA shall apply.

If MS, Microsoft Corporation, their affiliates and/or their designated agent make available Supplemental Components, and no other EULA terms are provided, then the terms of this EULA shall apply, except that the MS, Microsoft Corporation or affiliate entity providing the Supplemental Component(s) shall be the licensor of the Supplemental Component(s).

FORD MOTOR COMPANY, MS, Microsoft Corporation, their affiliates and/or their designated agent reserve the right to discontinue without liability any Internet-based services provided to you or made available to you through the use of the SOFTWARE.

# Appendices

---

- **Links to Third Party Sites:** The MS SOFTWARE may provide you with the ability to link to third party sites through the use of the SOFTWARE. The third party sites are not under the control of MS, Microsoft Corporation, their affiliates and/or their designated agent. Neither MS nor Microsoft Corporation nor their affiliates nor their designated agent are responsible for (i) the contents of any third party sites, any links contained in third party sites, or any changes or updates to third party sites, or (ii) webcasting or any other form of transmission received from any third party sites. If the SOFTWARE provides links to third party sites, those links are provided to you only as a convenience, and the inclusion of any link does not imply an endorsement of the third party site by MS, Microsoft Corporation, their affiliates and/or their designated agent.
- **Obligation to Drive Responsibly:** You recognize your obligation to drive responsibly and keep attention on the road. You will read and abide with the DEVICE operating instructions particularly as they pertain to safety and assumes any risk associated with the use of the DEVICE.

## **UPGRADES AND RECOVERY MEDIA:**

If the SOFTWARE is provided by FORD MOTOR COMPANY separate from the DEVICE on media such as a ROM chip, CD ROM disk(s) or via web download or other means, and is labeled "For Upgrade Purposes Only" or "For Recovery Purposes Only" you may install one (1) copy of such SOFTWARE onto the DEVICE as a replacement copy for the existing SOFTWARE, and use it in accordance with this EULA, including any additional EULA terms accompanying the upgrade SOFTWARE.

## **INTELLECTUAL PROPERTY RIGHTS:**

All title and intellectual property rights in and to the SOFTWARE (including but not limited to any images, photographs, animations, video, audio, music, text and "applets" incorporated into the SOFTWARE), the accompanying printed materials, and any copies of the SOFTWARE, are owned by MS, Microsoft Corporation, FORD MOTOR COMPANY, or their affiliates or suppliers. The SOFTWARE is licensed, not sold. You may not copy the printed materials accompanying the SOFTWARE. All title and intellectual property rights in and to the content which may be accessed through use of the SOFTWARE is the property of the respective content owner and may be protected by applicable copyright or other intellectual property laws and treaties. This EULA grants you no rights to use such content. All rights not specifically granted under this EULA are reserved by MS, Microsoft Corporation, FORD MOTOR COMPANY, third party software and service providers, their affiliates and suppliers. Use of any on-line services which may be accessed through the SOFTWARE may be governed by the respective terms of use relating to such services. If this SOFTWARE contains documentation that is provided only in electronic form, you may print one copy of such electronic documentation.

**EXPORT RESTRICTIONS:** You acknowledge that the SOFTWARE is subject to U.S. and European Union export jurisdiction. You agree to comply with all applicable international and national laws that apply to the SOFTWARE, including the U.S. Export Administration Regulations, as well as end-user, end-use and destination restrictions issued by U.S. and other governments. For additional information, see <http://www.microsoft.com/exporting/>.

# Appendices

---

**TRADEMARKS:** This EULA does not grant you any rights in connection with any trademarks or service marks of FORD MOTOR COMPANY, MS, Microsoft Corporation, third party software or service providers, their affiliates or suppliers.

**PRODUCT SUPPORT:** Product support for the SOFTWARE is not provided by MS, its parent corporation Microsoft Corporation, or their affiliates or subsidiaries. For product support, please refer to FORD MOTOR COMPANY instructions provided in the documentation for the DEVICE. Should you have any questions concerning this EULA, or if you desire to contact FORD MOTOR COMPANY for any other reason, please refer to the address provided in the documentation for the DEVICE.

**No Liability for Certain Damages:** EXCEPT AS PROHIBITED BY LAW, FORD MOTOR COMPANY, ANY THIRD PARTY SOFTWARE OR SERVICES SUPPLIERS, MS, MICROSOFT CORPORATION AND THEIR AFFILIATES SHALL HAVE NO LIABILITY FOR ANY INDIRECT, SPECIAL, CONSEQUENTIAL OR INCIDENTAL DAMAGES ARISING FROM OR IN CONNECTION WITH THE USE OR PERFORMANCE OF THE SOFTWARE. THIS LIMITATION SHALL APPLY EVEN IF ANY REMEDY FAILS OF ITS ESSENTIAL PURPOSE. IN NO EVENT SHALL MS, MICROSOFT CORPORATION AND/OR THEIR AFFILIATES BE LIABLE FOR ANY AMOUNT IN EXCESS OF U.S. TWO HUNDRED FIFTY DOLLARS (U.S. \$250.00).

- THERE ARE NO WARRANTIES OTHER THAN THOSE THAT MAY EXPRESSLY BE PROVIDED FOR YOUR NEW VEHICLE.

## **Adobe**

Contains Adobe® [Flash® Player] or [AIR®] technology by Adobe Systems Incorporated. This [Licensee Product] contains [Adobe® Flash® Player] [Adobe® AIR®] software under license from Adobe Systems Incorporated, Copyright ©1995-2009 Adobe Macromedia Software LLC. All rights reserved. Adobe, Flash and AIR are trademarks of Adobe Systems Incorporated.

## **End User Notice**

### **Microsoft® Windows® Mobile for Automotive Important Safety Information**

This system Ford SYNC™ contains software that is licensed to Manufacturer FORD MOTOR COMPANY by an affiliate of Microsoft Corporation pursuant to a license agreement. Any removal, reproduction, reverse engineering or other unauthorized use of the software from this system in violation of the license agreement is strictly prohibited and may subject you to legal action.

**Read and follow instructions:** Before using your Windows Automotive- based system, read and follow all instructions and safety information provided in this end user manual ("User's Guide"). Not following precautions found in this User's Guide can lead to an accident or other serious consequences.

**Keep User's Guide in vehicle:** When kept in the vehicle, the User's Guide will be a ready reference for you and other users unfamiliar with the Windows Automotive-based system. Please make certain that before using the system for the first time, all persons have access to the User's Guide and read its instructions and safety information carefully.

# Appendices

---

## WARNING



Operating certain parts of this system while driving can distract your attention away from the road, and possibly cause an accident or other serious consequences. Do not change system settings or enter data non-verbally (using your hands) while driving. Stop the vehicle in a safe and legal manner before attempting these operations. This is important since while setting up or changing some functions you might be required to distract your attention away from the road and remove your hands from the wheel.

---

### General Operation

**Voice Command Control:** Functions within the Windows Automotive-based system may be accomplished using only voice commands. Using voice commands while driving allows you to operate the system without removing your hands from the wheel.

**Prolonged Views of Screen:** Do not access any function requiring a prolonged view of the screen while you are driving. Pull over in a safe and legal manner before attempting to access a function of the system requiring prolonged attention. Even occasional short scans to the screen may be hazardous if your attention has been diverted away from your driving task at a critical time.

**Volume Setting:** Do not raise the volume excessively. Keep the volume at a level where you can still hear outside traffic and emergency signals while driving. Driving while unable to hear these sounds could cause an accident.

### Use of Speech Recognition Functions:

Speech recognition software is inherently a statistical process which is subject to errors. It is your responsibility to monitor any speech recognition functions included in the system and address any errors.

**Navigation Features:** Any navigation features included in the system are intended to provide turn by turn instructions to get you to a desired destination. Please make certain all persons using this system carefully read and follow instructions and safety information fully.

**Distraction Hazard:** Any navigation features may require manual (non-verbal) setup. Attempting to perform such set-up or insert data while driving can seriously distract your attention and could cause an accident or other serious consequences. Stop the vehicle in a safe and legal manner before attempting these operations.

**Let Your Judgment Prevail:** Any navigation features are provided only as an aid. Make your driving decisions based on your observations of local conditions and existing traffic regulations. Any such feature is not a substitute for your personal judgment. Any route suggestions made by this system should never replace any local traffic regulations or your personal judgment or knowledge of safe driving practices.

**Route Safety:** Do not follow the route suggestions if doing so would result in an unsafe or illegal maneuver, if you would be placed in an unsafe situation, or if you would be directed into an area that you consider unsafe. The driver is ultimately responsible for the safe operation of the vehicle and therefore, must evaluate whether it is safe to follow the suggested directions.

# Appendices

---

**Potential Map Inaccuracy:** Maps used by this system may be inaccurate because of changes in roads, traffic controls or driving conditions. Always use good judgment and common sense when following the suggested routes.

**Emergency Services:** Do not rely on any navigation features included in the system to route you to emergency services. Ask local authorities or an emergency services operator for these locations. Not all emergency services such as police, fire stations, hospitals and clinics are likely to be contained in the map database for such navigation features.

## **TeleNav Software End User License Agreement**

Please read these terms and conditions carefully before you use the TeleNav Software. Your use of the TeleNav Software indicates that you accept these terms and conditions. If you do not accept these terms and conditions, do not break the seal of the package, launch, or otherwise use the TeleNav Software.

TeleNav may revise this Agreement and the privacy policy at any time, with or without notice to you. You agree to visit <http://www.telenav.com> from time to time to review the then current version of this Agreement and of the privacy policy.

### **1. Safe and Lawful Use**

You acknowledge that devoting attention to the TeleNav Software may pose a risk of injury or death to you and others in situations that otherwise require your undivided attention, and you therefore agree to comply with the following when using the TeleNav Software: (a) observe all traffic laws and otherwise drive safely; (b) use your own personal judgment while driving. If you feel that a route suggested by the TeleNav Software instructs you to perform an unsafe or illegal maneuver,

places you in an unsafe situation, or directs you into an area that you consider to be unsafe, do not follow such instructions; (c) do not input destinations, or otherwise manipulate the TeleNav Software, unless your vehicle is stationary and parked; (d) do not use the TeleNav Software for any illegal, unauthorized, unintended, unsafe, hazardous, or unlawful purposes, or in any manner inconsistent with this Agreement; (e) arrange all GPS and wireless devices and cables necessary for use of the TeleNav Software in a secure manner in your vehicle so that they will not interfere with your driving and will not prevent the operation of any safety device (such as an airbag).

You agree to indemnify and hold TeleNav harmless against all claims resulting from any dangerous or otherwise inappropriate use of the TeleNav Software in any moving vehicle, including as a result of your failure to comply with the directions above.

### **2. Account Information**

You agree: (a) when registering the TeleNav Software, to provide TeleNav with true, accurate, current, and complete information about yourself, and (b) to inform TeleNav promptly of any changes to such information, and to keep it true, accurate, current and complete.

### **3. Software License**

Subject to your compliance with the terms of this Agreement, TeleNav hereby grants to you a personal, non-exclusive, non-transferable license (except as expressly permitted below in connection with your permanent transfer of the TeleNav Software license), without the right to sublicense, to use the TeleNav Software (in object code form only) in order to access and use the TeleNav Software. This license shall terminate upon

# Appendices

---

any termination or expiration of this Agreement. You agree that you will use the TeleNav Software only for your personal business or leisure purposes, and not to provide commercial navigation services to other parties.

## **3.1 License Limitations**

You agree not to do any of the following: (a) reverse engineer, decompile, disassemble, translate, modify, alter or otherwise change the TeleNav Software or any part thereof; (b) attempt to derive the source code, audio library or structure of the TeleNav Software without the prior express written consent of TeleNav; (c) remove from the TeleNav Software, or alter, any of TeleNav's or its suppliers' trademarks, trade names, logos, patent or copyright notices, or other notices or markings; (d) distribute, sublicense or otherwise transfer the TeleNav Software to others, except as part of your permanent transfer of the TeleNav Software; or (e) use the TeleNav Software in any manner that (i) infringes the intellectual property or proprietary rights, rights of publicity or privacy or other rights of any party, (ii) violates any law, statute, ordinance or regulation, including but not limited to laws and regulations related to spamming, privacy, consumer and child protection, obscenity or defamation, or (iii) is harmful, threatening, abusive, harassing, tortuous, defamatory, vulgar, obscene, libelous, or otherwise objectionable; and (f) lease, rent out, or otherwise permit unauthorized access by third parties to the TeleNav Software without advanced written permission of TeleNav.

## **4. Disclaimers**

To the fullest extent permissible pursuant to applicable law, in no event will TeleNav, its licensors and suppliers, or agents or employees of any of the foregoing, be liable for any decision made or action taken by you or anyone else in reliance on the information provided by the TeleNav Software. TeleNav also does not warrant the accuracy of the map or other data used for the TeleNav Software. Such data may not always reflect reality due to, among other things, road closures, construction, weather, new roads and other changing conditions. You are responsible for the entire risk arising out of your use of the TeleNav Software. For example but without limitation, you agree not to rely on the TeleNav Software for critical navigation in areas where the well-being or survival of you or others is dependent on the accuracy of navigation, as the maps or functionality of the TeleNav Software are not intended to support such high risk applications, especially in more remote geographical areas.

TELENAV EXPRESSLY DISCLAIMS AND EXCLUDES ALL WARRANTIES IN CONNECTION WITH THE TELENAV SOFTWARE, WHETHER STATUTORY, EXPRESS OR IMPLIED, INCLUDING ALL WARRANTIES WHICH MAY ARISE FROM COURSE OF DEALING, CUSTOM OR TRADE AND INCLUDING, BUT NOT LIMITED TO, THE IMPLIED WARRANTIES OF MERCHANTABILITY, FITNESS FOR A PARTICULAR PURPOSE AND NON-INFRINGEMENT OF THIRD PARTY RIGHTS WITH RESPECT TO THE TELENAV SOFTWARE. Certain jurisdictions do not permit the disclaimer of certain warranties, so this limitation may not apply to you.

# Appendices

---

## **5. Limitation of Liability**

TO THE EXTENT PERMITTED UNDER APPLICABLE LAW, UNDER NO CIRCUMSTANCES SHALL TELENAV OR ITS LICENSORS AND SUPPLIERS BE LIABLE TO YOU OR TO ANY THIRD PARTY FOR ANY INDIRECT, INCIDENTAL, CONSEQUENTIAL, SPECIAL OR EXEMPLARY DAMAGES (INCLUDING IN EACH CASE, BUT NOT LIMITED TO, DAMAGES FOR THE INABILITY TO USE THE EQUIPMENT OR ACCESS DATA, LOSS OF DATA, LOSS OF BUSINESS, LOSS OF PROFITS, BUSINESS INTERRUPTION OR THE LIKE) ARISING OUT OF THE USE OF OR INABILITY TO USE THE TELENAV SOFTWARE, EVEN IF TELENAV HAS BEEN ADVISED OF THE POSSIBILITY OF SUCH DAMAGES.

NOTWITHSTANDING ANY DAMAGES THAT YOU MIGHT INCUR FOR ANY REASON WHATSOEVER (INCLUDING, WITHOUT LIMITATION, ALL DAMAGES REFERENCED HEREIN AND ALL DIRECT OR GENERAL DAMAGES IN CONTRACT, TORT (INCLUDING NEGLIGENCE) OR OTHERWISE), THE ENTIRE LIABILITY OF TELENAV AND OF ALL OF TELENAV'S SUPPLIERS SHALL BE LIMITED TO THE AMOUNT ACTUALLY PAID BY YOU FOR THE TELENAV SOFTWARE. SOME STATES AND/OR JURISDICTIONS DO NOT ALLOW THE EXCLUSION OR LIMITATION OF INCIDENTAL OR CONSEQUENTIAL DAMAGES, SO THE ABOVE LIMITATIONS OR EXCLUSIONS MAY NOT APPLY TO YOU.

## **6. Arbitration and Governing Law**

You agree that any dispute, claim or controversy arising out of or relating to this Agreement or the TeleNav Software shall be settled by independent arbitration involving a neutral arbitrator and administered by the American Arbitration Association in the County of Santa Clara, California. The arbitrator shall apply the

Commercial Arbitration Rules of the American Arbitration Association, and the judgment upon the award rendered by the arbitrator may be entered by any court having jurisdiction. Note that there is no judge or jury in an arbitration proceeding and the decision of the arbitrator shall be binding upon both parties. You expressly agree to waive your right to a jury trial.

This Agreement and performance hereunder will be governed by and construed in accordance with the laws of the State of California, without giving effect to its conflict of laws provisions. To the extent judicial action is necessary in connection with the binding arbitration, both TeleNav and you agree to submit to the exclusive jurisdiction of the courts of the County of Santa Clara, California. The United Nations Convention on Contracts for the International Sale of Goods shall not apply.

## **7. Assignment**

You may not resell, assign, or transfer this Agreement or any of your rights or obligations, except in totality, in connection with your permanent transfer of the TeleNav Software, and expressly conditioned upon the new user of the TeleNav Software agreeing to be bound by the terms and conditions of this Agreement. Any such sale, assignment or transfer that is not expressly permitted under this paragraph will result in immediate termination of this Agreement, without liability to TeleNav, in which case you and all other parties shall immediately cease all use of the TeleNav Software. Notwithstanding the foregoing, TeleNav may assign this Agreement to any other party at any time without notice, provided the assignee remains bound by this Agreement.



# Appendices

---

## **8. Miscellaneous**

### **8.1**

This Agreement constitutes the entire agreement between TeleNav and you with respect to the subject matter hereof.

### **8.2**

Except for the limited licenses expressly granted in this Agreement, TeleNav retains all right, title and interest in and to the TeleNav Software, including without limitation all related intellectual property rights. No licenses or other rights which are not expressly granted in this Agreement are intended to, or shall be, granted or conferred by implication, statute, inducement, estoppel or otherwise, and TeleNav and its suppliers and licensors hereby reserve all of their respective rights other than the licenses explicitly granted in this Agreement

### **8.3**

By using the TeleNav Software, you consent to receive from TeleNav all communications, including notices, agreements, legally required disclosures or other information in connection with the TeleNav Software (collectively, "Notices") electronically. TeleNav may provide such Notices by posting them on TeleNav's Website or by downloading such Notices to your wireless device. If you desire to withdraw your consent to receive Notices electronically, you must discontinue your use of the TeleNav Software.

### **8.4**

TeleNav's or your failure to require performance of any provision shall not affect that party's right to require performance at any time thereafter, nor shall a waiver of any breach or default of this Agreement constitute a waiver of any subsequent breach or default or a waiver of the provision itself.

### **8.5**

If any provision herein is held unenforceable, then such provision will be modified to reflect the intention of the parties, and the remaining provisions of this Agreement will remain in full force and effect

### **8.6**

The headings in this Agreement are for convenience of reference only, will not be deemed to be a part of this Agreement, and will not be referred to in connection with the construction or interpretation of this Agreement. As used in this Agreement, the words "include" and "including" and variations thereof, will not be deemed to be terms of limitation, but rather will be deemed to be followed by the words "without limitation".

## **9. Other Vendors Terms and Conditions**

The TeleNav Software utilizes map and other data licensed to TeleNav by third party vendors for the benefit of you and other end users. This Agreement includes end-user terms applicable to these companies (included at the end of this Agreement), and thus your use of the TeleNav Software is also subject to such terms. You agree to comply with the following additional terms and conditions, which are applicable to TeleNav's third party vendor licensors:

### **NavTeq End User License Agreement**

#### **END USER TERMS**

The content provided ("Data") is licensed, not sold. By opening this package, or installing, copying, or otherwise using the Data, you agree to be bound by the terms of this agreement. If you do not agree to the terms of this agreement, you are not permitted to install, copy, use, resell or transfer the Data. If you wish to reject the terms of this agreement, and have not



# Appendices

---

installed, copied, or used the Data, you must contact your retailer or NAVTEQ North America, LLC ("NT") within thirty (30) days of purchase for a refund of your purchase price. To contact NT, please visit [www.navteq.com](http://www.navteq.com).

The Data is provided for your personal, internal use only and may not be resold. It is protected by copyright, and is subject to the following terms (this "End User License Agreement") and conditions which are agreed to by you, on the one hand, and NAVTEQ North America, LLC ("NT") and its licensors (including their licensors and suppliers) on the other hand.

The Data for areas of Canada includes information taken with permission from Canadian authorities, including: © Her Majesty the Queen in Right of Canada, © Queen's Printer for Ontario, © Canada Post Corporation, GeoBase®.

NT holds a nonexclusive license from the United States Postal Service ® to publish and sell ZIP+4 ® information.

© United States Postal Service ® 2009. Prices are not established, controlled or approved by the United States Postal Service ®. The following trademarks and registrations are owned by the USPS: United States Postal Service, USPS, and ZIP+4.

The Data for Mexico includes certain Data from Instituto Nacional de Estadística y Geografía.

## TERMS AND CONDITIONS

**License Limitations on Use:** You agree that your license to use this Data is limited to and conditioned on use for solely personal, noncommercial purposes, and not for service bureau, timesharing or other similar purposes. Except as otherwise set forth herein, you agree not to otherwise

reproduce, copy, modify, decompile, disassemble or reverse engineer any portion of this Data, and may not transfer or distribute it in any form, for any purpose, except to the extent permitted by mandatory laws.

**License Limitations on Transfer:** Your limited license does not allow transfer or resale of the Data, except on the condition that you may transfer the Data and all accompanying materials on a permanent basis if: (a) you retain no copies of the Data; (b) the recipient agrees to the terms of this End User License Agreement; and (c) you transfer the Data in the exact same form as you purchased it by physically transferring the original media (e.g., the CD-ROM or DVD you purchased), all original packaging, all Manuals and other documentation. Specifically, Multi-disc sets may only be transferred or sold as a complete set as provided to you and not as a subset thereof.

**Additional License Limitations:** Except where you have been specifically licensed to do so by NT in a separate written agreement, and without limiting the preceding paragraph, your license is conditioned on use of the Data as prescribed in this agreement, and you may not (a) use this Data with any products, systems, or applications installed or otherwise connected to or in communication with vehicles capable of vehicle navigation, positioning, dispatch, real time route guidance, fleet management or similar applications; or (b) with, or in communication with, including without limitation, cellular phones, palmtop and handheld computers, pagers, and personal digital assistants or PDAs.

# Appendices

## WARNING



This Data may contain inaccurate or incomplete information due to the passage of time, changing circumstances, sources used and the nature of collecting comprehensive geographic Data, any of which may lead to incorrect results.

**No Warranty:** This Data is provided to you "as is", and you agree to use it at your own risk. NT and its licensors (and their licensors and suppliers) make no guarantees, representations or warranties of any kind, express or implied, arising by law or otherwise, including but not limited to, content, quality, accuracy, completeness, effectiveness, reliability, fitness for a particular purpose, usefulness, use or results to be obtained from this Data, or that the Data or server will be uninterrupted or error free.

**Disclaimer of Warranty:** NT AND ITS LICENSORS (INCLUDING THEIR LICENSORS AND SUPPLIERS) DISCLAIM ANY WARRANTIES, EXPRESS OR IMPLIED, OF QUALITY, PERFORMANCE, MERCHANTABILITY, FITNESS FOR A PARTICULAR PURPOSE OR NON-INFRINGEMENT. Some States, Territories and Countries do not allow certain warranty exclusions, so to that extent the above exclusion may not apply to you.

**Disclaimer of Liability:** NT AND ITS LICENSORS (INCLUDING THEIR LICENSORS AND SUPPLIERS) SHALL NOT BE LIABLE TO YOU IN RESPECT OF ANY CLAIM, DEMAND OR ACTION, IRRESPECTIVE OF THE NATURE OF THE CAUSE OF THE CLAIM, DEMAND OR ACTION ALLEGING ANY LOSS, INJURY OR DAMAGES, DIRECT OR INDIRECT, WHICH MAY RESULT FROM THE USE OR POSSESSION OF THIS DATA; OR FOR ANY LOSS OF PROFIT, REVENUE, CONTRACTS

OR SAVINGS, OR ANY OTHER DIRECT, INDIRECT, INCIDENTAL, SPECIAL OR CONSEQUENTIAL DAMAGES ARISING OUT OF YOUR USE OF OR INABILITY TO USE THIS DATA, ANY DEFECT IN THIS DATA, OR THE BREACH OF THESE TERMS OR CONDITIONS, WHETHER IN AN ACTION IN CONTRACT OR TORT OR BASED ON A WARRANTY, EVEN IF NT OR ITS LICENSORS HAVE BEEN ADVISED OF THE POSSIBILITY OF SUCH DAMAGES. Some States, Territories and Countries do not allow certain liability exclusions or damages limitations, so to that extent the above may not apply to you.

**Export Control:** You agree not to export from anywhere any part of the Data or any direct product thereof except in compliance with, and with all licenses and approvals required under, applicable export laws, rules and regulations, including but not limited to the laws, rules and regulations administered by the Office of Foreign Assets Control of the U.S. Department of Commerce and the Bureau of Industry and Security of the U.S. Department of Commerce. To the extent that any such export laws, rules or regulations prohibit NT from complying with any of its obligations hereunder to deliver or distribute Data, such failure shall be excused and shall not constitute a breach of this Agreement.

**Entire Agreement:** These terms and conditions constitute the entire agreement between NT (and its licensors, including their licensors and suppliers) and you pertaining to the subject matter hereof, and supersedes in their entirety any and all written or oral agreements previously existing between us with respect to such subject matter.

# Appendices

---

**Severability:** You and NT agree that if any portion of this agreement is found illegal or unenforceable, that portion shall be severed and the remainder of the Agreement shall be given full force and effect.

**Governing Law:** The above terms and conditions shall be governed by the laws of the State of Illinois, without giving effect to (i) its conflict of laws provisions, or (ii) the United Nations Convention for Contracts for the International Sale of Goods, which is explicitly excluded. You agree to submit to the personal jurisdiction of the State of Illinois for any and all disputes, claims and actions arising from or in connection with the Data provided to you hereunder.

**Government End Users:** If the Data is being acquired by or on behalf of the United States government or any other entity seeking or applying rights similar to those customarily claimed by the United States government, this Data is a "commercial term" as that term is defined at 48 C.F.R. ("FAR") 2.101, is licensed in accordance with this End User License Agreement, and each copy of Data delivered or otherwise furnished shall be marked and embedded as appropriate with the following "Notice of Use", and be treated in accordance with such Notice:

## **NOTICE OF USE**

CONTRACTOR  
(MANUFACTURER/SUPPLIER)

NAME:

## **NAVTEQ**

CONTRACTOR  
(MANUFACTURER/SUPPLIER)

ADDRESS:

**425 West Randolph Street, Chicago, IL 60606.**

This Data is a commercial item as defined in FAR 2.101

and is subject to the End User License Agreement under

which this Data was provided.

© 2011 NAVTEQ. All rights reserved.

If the Contracting Officer, federal government agency, or any federal official refuses to use the legend provided herein, the Contracting Officer, federal government agency, or any federal official must notify NAVTEQ prior to seeking additional or alternative rights in the Data.

Wi-Fi hotspot data provided by JiWire, © 2013 JiWire.

## **Gracenote® Copyright**

CD and music-related data from Gracenote, Inc., copyright© 2000–2007 Gracenote. Gracenote Software, copyright © 2000–2007 Gracenote. This product and service may practice one or more of the following U.S. Patents #5,987,525, #6,061,680, #6,154,773, #6,161,132, #6,230,192, #6,230,207, #6,240,459, #6,330,593 and other patents issued or pending. Some services supplied under license from Open Globe, Inc. for U.S. Patent: #6,304,523.

Gracenote and CDDB are registered trademarks of Gracenote. The Gracenote logo and logotype, and the "Powered by Gracenote™" logo are trademarks of Gracenote.

## **Gracenote® End User License Agreement (EULA)**

This device contains software from Gracenote, Inc. of 2000 Powell Street Emeryville, California 94608 ("Gracenote").

## Appendices

---

The software from Gracenote (the "Gracenote Software") enables this device to do disc and music file identification and obtain music-related information, including name, artist, track, and title information ("Gracenote Data") from online servers ("Gracenote Servers"), and to perform other functions. You may use Gracenote Data only by means of the intended End User functions of this device.

This device may contain content belonging to Gracenote's providers. If so, all of the restrictions set forth herein with respect to Gracenote Data shall also apply to such content and such content providers shall be entitled to all of the benefits and protections set forth herein that are available to Gracenote.

You agree that you will use the content from Gracenote ("Gracenote Content"), Gracenote Data, the Gracenote Software, and Gracenote Servers for your own personal, non-commercial use only. You agree not to assign, copy, transfer or transmit the Gracenote Content, Gracenote Software or any Gracenote Data (except in a Tag associated with a music file) to any third party. YOU AGREE NOT TO USE OR EXPLOIT GRACENOTE CONTENT, GRACENOTE DATA, THE GRACENOTE SOFTWARE, OR GRACENOTE SERVERS, EXCEPT AS EXPRESSLY PERMITTED HEREIN.

You agree that your non-exclusive licenses to use the Gracenote Content, Gracenote Data, the Gracenote Software, and Gracenote Servers will terminate if you violate these restrictions. If your licenses terminate, you agree to cease any and all use of the Gracenote Content, Gracenote Data, the Gracenote Software, and Gracenote Servers. Gracenote, respectively, reserve all rights in Gracenote Data, the Gracenote Software, and the Gracenote Servers and Gracenote Content, including all ownership rights. Under no circumstances will either Gracenote

become liable for any payment to you for any information that you provide, including any copyrighted material or music file information. You agree that Gracenote may enforce its respective rights, collectively or separately, under this agreement against you, directly in each company's own name.

Gracenote uses a unique identifier to track queries for statistical purposes. The purpose of a randomly assigned numeric identifier is to allow Gracenote to count queries without knowing anything about who you are. For more information, see the web page at [www.gracenote.com](http://www.gracenote.com) for the Gracenote Privacy Policy.

THE GRACENOTE SOFTWARE, EACH ITEM OF GRACENOTE DATA AND THE GRACENOTE CONTENT ARE LICENSED TO YOU "AS IS". NEITHER GRACENOTE MAKES ANY REPRESENTATIONS OR WARRANTIES, EXPRESS OR IMPLIED, REGARDING THE ACCURACY OF ANY GRACENOTE DATA FROM THE GRACENOTE SERVERS OR GRACENOTE CONTENT. GRACENOTE COLLECTIVELY AND SEPARATELY RESERVE THE RIGHT TO DELETE DATA AND/OR CONTENT FROM THE COMPANIES' RESPECTIVE SERVERS OR, IN THE CASE OF GRACENOTE, CHANGE DATA CATEGORIES FOR ANY CAUSE THAT GRACENOTE DEEMS SUFFICIENT. NO WARRANTY IS MADE THAT EITHER GRACENOTE CONTENT OR THE GRACENOTE SOFTWARE OR GRACENOTE SERVERS ARE ERROR-FREE OR THAT THE FUNCTIONING OF THE GRACENOTE SOFTWARE OR GRACENOTE SERVERS WILL BE UNINTERRUPTED. GRACENOTE IS NOT OBLIGATED TO PROVIDE YOU WITH ANY ENHANCED OR ADDITIONAL DATA TYPES THAT GRACENOTE MAY CHOOSE TO PROVIDE IN THE FUTURE AND IS FREE TO DISCONTINUE ITS ONLINE SERVICES AT ANY TIME. GRACENOTE DISCLAIMS ALL

# Appendices

---

WARRANTIES EXPRESS OR IMPLIED, INCLUDING, BUT NOT LIMITED TO, IMPLIED WARRANTIES OF MERCHANTABILITY, FITNESS FOR A PARTICULAR PURPOSE, TITLE, AND NON-INFRINGEMENT. NEITHER GRACENOTE WARRANTS THE RESULTS THAT WILL BE OBTAINED BY YOUR USE OF THE GRACENOTE SOFTWARE OR ANY GRACENOTE SERVER. IN NO CASE WILL GRACENOTE BE LIABLE FOR ANY CONSEQUENTIAL OR INCIDENTAL DAMAGES OR FOR ANY LOST PROFITS OR LOST REVENUES FOR ANY REASON WHATSOEVER.

© Gracenote 2007.

FCC ID: KMHSYNG2

IC: 1422A-SYNG2

This device complies with Part 15 of the FCC Rules and with RSS-210 of Industry Canada. Operation is subject to the following two conditions: (1) This device may not cause harmful interference, and (2) this device must accept any interference received, including interference that may cause undesired operation.

## WARNING



Changes or modifications not expressly approved by the party responsible for compliance could void the user's authority to operate the equipment. The term "IC" before the radio certification number only signifies that Industry Canada technical specifications were met.

The antenna used for this transmitter must not be co-located or operating in conjunction with any other antenna or transmitter.

# Scheduled Maintenance

---

## General Maintenance Information

### Why Maintain Your Vehicle?

Carefully following the maintenance schedule helps protect against major repair expenses resulting from neglect or inadequate maintenance and may also help to increase the value of your vehicle when you sell or trade it. Keep all receipts for completed maintenance with your vehicle.

Regular maintenance intervals for your vehicle have been established based upon rigorous testing. It is important that you have your vehicle serviced at the proper times. These intervals serve two purposes; one is to maintain the reliability of your vehicle and the second is to keep your cost of owning your vehicle down.

It is your responsibility to see that all scheduled maintenance is performed and that the materials used meet the specifications identified in this owner's manual. See **Capacities and Specifications** (page 235).

Failure to perform scheduled maintenance invalidates warranty coverage on parts affected by the lack of maintenance.

### Why Maintain Your Vehicle at Your Dealership?

#### **Factory-Trained Technicians**

Service technicians participate in extensive factory-sponsored certification training to help them become experts on the operation of your vehicle. Ask your dealership about the training and certification their technicians have received.

### **Genuine Ford and Motorcraft® Replacement Parts**

Dealerships stock Ford, Motorcraft and Ford-authorized branded re-manufactured replacement parts. These parts meet or exceed our specifications. Parts installed at your dealership carry a nationwide 12 month or 12000 mile (20000 kilometer) parts and labor limited warranty.

If you do not use Ford authorized parts they may not meet our specifications and depending on the part it could affect emissions compliance.

#### **Convenience**

Many dealerships have extended evening and Saturday hours to make your service visit more convenient and they offer one stop shopping. They can perform any services that are required on your vehicle, from general maintenance to collision repairs.

**Note:** *Not all dealers have extended hours or body shops. Please contact your dealer for details.*

#### **Protecting Your Investment**

Maintenance is an investment that pays dividends in the form of improved reliability, durability and resale value. To maintain the proper performance of your vehicle and its emission control systems, it is imperative that scheduled maintenance be completed at the designated intervals.

Your vehicle is equipped with a message center which displays a message in the information display at the proper oil change service interval. This interval is one year or 10000 miles (16000 kilometers) under normal driving conditions.

# Scheduled Maintenance

---

When **ENGINE OIL CHANGE DUE** or **OIL CHANGE REQUIRED** appears in the information display, it is time for an oil change. The oil change must be done within two weeks or 500 miles (800 kilometers) of the message appearing. The oil minder system must be reset after each oil change. See **Engine Oil Check** (page 182).

If your information display is prematurely reset or becomes inoperative, you should perform the oil change interval at six months or 5000 miles (8000 kilometers) from your last oil change. Never exceed one year or 10000 miles (16000 kilometers) between oil change intervals.

Your vehicle is very sophisticated and built with multiple, complex, performance systems. Every manufacturer develops these systems using different specifications and performance features. That is why it is important to rely upon your dealership to properly diagnose and repair your vehicle.

Ford Motor Company has recommended maintenance intervals for various parts and component systems based upon engineering testing. Ford Motor Company relies upon this testing to determine the most appropriate mileage for replacement of oils and fluids to protect your vehicle at the lowest overall cost to you and recommends against maintenance schedules that deviate from the scheduled maintenance information.

Ford strongly recommends the use of only genuine Ford, Motorcraft® or Ford-authorized re-manufactured replacement parts because they are engineered for your vehicle.

## **Additives and Chemicals**

Recommended additives and chemicals are listed in this owner's manual and in the Ford Workshop Manual. Additional chemicals or additives not approved by Ford Motor Company are not recommended as part of normal maintenance. Please consult your warranty information.

## **Oils, Fluids and Flushing**

In many cases, fluid discoloration is a normal operating characteristic and, by itself, does not necessarily indicate a concern or that the fluid needs to be changed. However, discolored fluids that also show signs of overheating or foreign material contamination should be inspected immediately by a qualified expert, such as the factory-trained technicians at your dealership.

Your vehicle's oils and fluids should be changed at the specified intervals or in conjunction with a repair. Flushing is a viable way to change fluid for many vehicle sub-systems during scheduled maintenance. It is critical that systems are flushed only with new fluid that is the same as that required to fill and operate the system or using a Ford-approved flushing chemical.

## **Owner Checks and Services**

Certain basic maintenance checks and inspections should be performed every month or at six month intervals.

### **Check Every Month**

- Engine oil level.
- Function of all interior and exterior lights.
- Tires (including spare) for wear and proper pressure.
- Windshield washer fluid level.

# Scheduled Maintenance

## Check Every Six Months

- Battery connections. Clean if necessary.
- Body and door drain holes for obstructions. Clean if necessary.
- Cooling system fluid level and coolant strength.
- Door weatherstrips for wear. Lubricate if necessary.
- Hinges, latches and outside locks for proper operation. Lubricate if necessary.
- Parking brake for proper operation.
- Safety belts and seat latches for wear and function.

- Safety warning lamps (brake, ABS, airbag and safety belt) for operation.
- Washer spray and wiper operation. Clean or replace blades as necessary.

## Multi-point Inspection

In order to keep your vehicle running right, it is important to have the systems on your vehicle checked regularly. This can help identify potential issues and prevent major problems. We recommend the following multi-point inspection be performed at every scheduled maintenance interval to help ensure your vehicle keeps running great.

Multi-point Inspection	
Accessory drive belt(s)	Half-shaft dust boots
Battery performance	Horn operation
Clutch operation (if equipped)	Radiator, cooler, heater and A/C hoses
Engine air filter	Suspension components for leaks or damage
Exhaust system	Steering and linkage
Exterior lamps and hazard warning system operation	Tires (including spare) for wear and proper pressure
Fluid levels*; fill if necessary	Windshield for cracks, chips or pits
For oil and fluid leaks	Washer spray and wiper operation

\* Brake, coolant recovery reservoir, automatic transmission and window washer

Be sure to ask your dealership service advisor or technician about the multi-point vehicle inspection. It is a comprehensive way to perform a thorough inspection of your vehicle. It is your checklist that gives you immediate feedback on the overall

condition of your vehicle. You know what has been checked, what is okay as well as those things that may require future or immediate attention. The multi-point vehicle inspection is one more way to keep your vehicle running great.



# Scheduled Maintenance

## Normal Scheduled Maintenance

Your vehicle is equipped with an oil minder system that indicates when the engine oil should be changed under normal operating conditions.

This means you do not have to remember to change the oil on a mileage-based schedule; the vehicle lets you know when an oil change is due by displaying **ENGINE OIL CHANGE DUE** or **OIL CHANGE REQUIRED** in the information display.

Every 10000 miles (16000 kilometers) or 12 months
Change engine oil and filter.**
Rotate the tires.
Perform a multi-point inspection (recommended).
Inspect the automatic transmission fluid level. Consult your dealer for requirements.
Inspect the brake pads, shoes, rotors, drums, brake linings, hoses and parking brake.
Inspect the cabin air filter.
Inspect the engine cooling system strength and hoses.
Inspect the exhaust system and heat shields.
Inspect the half-shaft boots.
Inspect the steering linkage, ball joints, suspension, tire-rod ends, driveshaft and U-joints. Lubricate any areas with grease fittings.
Inspect the tires, tire wear and measure the tread depth.
Inspect the wheels and related components for abnormal noise, wear, looseness or drag.

\* Do not exceed one year or 10000 miles (16000 kilometers) between service intervals.

\*\* Reset the oil minder system after each engine oil and filter change. See **Engine Oil Check** (page 182).

Additional Maintenance Items <sup>1</sup>	
Every 20000 miles (32000 km)	Replace cabin air filter.
Every 30000 miles (48000 km)	Replace engine air filter.
At 100000 miles (160000 km)	Change engine coolant. <sup>2</sup>

# Scheduled Maintenance

Additional Maintenance Items <sup>1</sup>	
Every 100000 miles (160000 km)	Replace spark plugs.
	Inspect accessory drive belt(s). <sup>3</sup>
Every 150000 miles (240000 km)	Change transmission fluid.
	Replace accessory drive belt(s). <sup>4</sup>
	Replace timing belt (1.0L, 1.6L engine).
	Replace oil pump drive belt.

<sup>1</sup> Additional maintenance items can be performed within 3000 miles (4800 kilometers) of the last engine oil and filter change. Do not exceed the designated distance for the interval.

<sup>2</sup> Initial replacement at six years or 100000 miles (160000 kilometers), then every three years or 50000 miles (80000 kilometers).

<sup>3</sup> After initial inspection, inspect every other oil change until replaced.

<sup>4</sup> If not replaced within the last 100000 miles (160000 kilometers).

## Maintenance Schedule Log

<input type="radio"/> Repair Order #:	Dealer stamp
<input type="radio"/> Distance:	
<input type="radio"/> Engine hours (optional):	
<input type="radio"/> Multi-point inspection (recommended): <input type="checkbox"/>	
<input type="radio"/> Signature:	

# Scheduled Maintenance

<input type="radio"/> Repair Order #:	<p>Dealer stamp</p>
<input type="radio"/> Distance:	
<input type="radio"/> Engine hours (optional):	
<input type="radio"/> Multi-point inspection (recommended): <input type="checkbox"/>	
<input type="radio"/> Signature:	

<input type="radio"/> Repair Order #:	<p>Dealer stamp</p>
<input type="radio"/> Distance:	
<input type="radio"/> Engine hours (optional):	
<input type="radio"/> Multi-point inspection (recommended): <input type="checkbox"/>	
<input type="radio"/> Signature:	

<input type="radio"/> Repair Order #:	<p>Dealer stamp</p>
<input type="radio"/> Distance:	
<input type="radio"/> Engine hours (optional):	
<input type="radio"/> Multi-point inspection (recommended): <input type="checkbox"/>	
<input type="radio"/> Signature:	

# Scheduled Maintenance

<input type="radio"/> Repair Order #:	<p>Dealer stamp</p>	<input type="radio"/> Signature:
<input type="radio"/> Distance:		
<input type="radio"/> Engine hours (optional):		
<input type="radio"/> Multi-point inspection (recommended): <input type="checkbox"/>		

<input type="radio"/> Repair Order #:	<p>Dealer stamp</p>	<input type="radio"/> Signature:
<input type="radio"/> Distance:		
<input type="radio"/> Engine hours (optional):		
<input type="radio"/> Multi-point inspection (recommended): <input type="checkbox"/>		

<input type="radio"/> Repair Order #:	<p>Dealer stamp</p>	<input type="radio"/> Signature:
<input type="radio"/> Distance:		
<input type="radio"/> Engine hours (optional):		
<input type="radio"/> Multi-point inspection (recommended): <input type="checkbox"/>		

# Scheduled Maintenance

<input type="radio"/> Repair Order #:	<p>Dealer stamp</p>
<input type="radio"/> Distance:	
<input type="radio"/> Engine hours (optional):	
<input type="radio"/> Multi-point inspection (recommended): <input type="checkbox"/>	
<input type="radio"/> Signature:	

<input type="radio"/> Repair Order #:	<p>Dealer stamp</p>
<input type="radio"/> Distance:	
<input type="radio"/> Engine hours (optional):	
<input type="radio"/> Multi-point inspection (recommended): <input type="checkbox"/>	
<input type="radio"/> Signature:	

<input type="radio"/> Repair Order #:	<p>Dealer stamp</p>
<input type="radio"/> Distance:	
<input type="radio"/> Engine hours (optional):	
<input type="radio"/> Multi-point inspection (recommended): <input type="checkbox"/>	
<input type="radio"/> Signature:	

# Scheduled Maintenance

<input type="radio"/> Repair Order #:	<p>Dealer stamp</p>
<input type="radio"/> Distance:	
<input type="radio"/> Engine hours (optional):	
<input type="radio"/> Multi-point inspection (recommended): <input type="checkbox"/>	
<input type="radio"/> Signature:	

<input type="radio"/> Repair Order #:	<p>Dealer stamp</p>
<input type="radio"/> Distance:	
<input type="radio"/> Engine hours (optional):	
<input type="radio"/> Multi-point inspection (recommended): <input type="checkbox"/>	
<input type="radio"/> Signature:	

## Special Operating Conditions

If you operate your vehicle **primarily** in any of the following conditions, you need to perform additional maintenance as indicated. If you operate your vehicle **occasionally** under any of these conditions, it is not necessary to perform the additional maintenance. For specific recommendations, see your dealership service advisor or technician.

## Scheduled Maintenance

<b>Towing a Trailer or Using a Car-top Carrier</b>	
As required	Change engine oil and filter as indicated by the information display and perform services listed in the Normal Scheduled Maintenance chart.
Inspect frequently, service as required	Inspect and lubricate U-joints.
Every 30000 miles (48000 km)	Change automatic transmission fluid.
Every 60000 miles (96000 km)	Change manual transmission fluid.

<b>Extensive Idling or Low-speed Driving for Long Distances, as in Heavy Commercial Use (i.e. Delivery, Taxi, Patrol Car or Livery)</b>	
As required	Change engine oil and filter as indicated by the information display and perform services listed in the Normal Scheduled Maintenance chart.
Inspect frequently, service as required	Replace cabin air filter (if equipped). Replace engine air filter.
Every 30000 miles (48000 km)	Change automatic transmission fluid.
Every 60000 miles (96000 km)	Replace spark plugs.

<b>Operating in Dusty or Sandy Conditions Such as Unpaved or Dusty Roads</b>	
Inspect frequently, service as required	Replace cabin air filter (if equipped). Replace engine air filter.
Every 5000 miles (8000 km)	Inspect the wheels and related components for abnormal noise, wear, looseness or drag. Rotate tires, inspect tires for wear and measure tread depth.
Every 5000 miles (8000 km) or six months	Change engine oil and filter. Perform multi-point inspection.

# Scheduled Maintenance

Operating in Dusty or Sandy Conditions Such as Unpaved or Dusty Roads	
Every 30000 miles (48000 km)	Change automatic transmission fluid.
Every 50000 miles (80000 km)	Change manual transmission fluid.

Reset your oil life monitor system after each engine oil and filter change. See **Engine Oil Check** (page 182).

Exclusive Use of E85 (Flex Fuel Vehicles only)	
Every oil change	If ran exclusively on E85, fill the fuel tank full with regular unleaded fuel.

## Special Operating Condition Log

Repair Order #:

Distance:

Engine hours (optional):

Multi-point inspection (recommended):

Dealer stamp

Signature:



# Scheduled Maintenance

<input type="radio"/> Repair Order #:	<p>Dealer stamp</p>
<input type="radio"/> Distance:	
<input type="radio"/> Engine hours (optional):	
<input type="radio"/> Multi-point inspection (recommended): <input type="checkbox"/>	
<input type="radio"/> Signature:	

<input type="radio"/> Repair Order #:	<p>Dealer stamp</p>
<input type="radio"/> Distance:	
<input type="radio"/> Engine hours (optional):	
<input type="radio"/> Multi-point inspection (recommended): <input type="checkbox"/>	
<input type="radio"/> Signature:	

<input type="radio"/> Repair Order #:	<p>Dealer stamp</p>
<input type="radio"/> Distance:	
<input type="radio"/> Engine hours (optional):	
<input type="radio"/> Multi-point inspection (recommended): <input type="checkbox"/>	
<input type="radio"/> Signature:	

# Scheduled Maintenance

<input type="radio"/> Repair Order #:	<p>Dealer stamp</p>
<input type="radio"/> Distance:	
<input type="radio"/> Engine hours (optional):	
<input type="radio"/> Multi-point inspection (recommended): <input type="checkbox"/>	
<input type="radio"/> Signature:	

<input type="radio"/> Repair Order #:	<p>Dealer stamp</p>
<input type="radio"/> Distance:	
<input type="radio"/> Engine hours (optional):	
<input type="radio"/> Multi-point inspection (recommended): <input type="checkbox"/>	
<input type="radio"/> Signature:	

## Exceptions

There are some exceptions your Normal Scheduled Maintenance:

**California fuel filter replacement:** If the vehicle is registered in California, the California Air Resources Board has determined that the failure to perform this maintenance item will not nullify the emission warranty or limit recall liability

prior to the completion of the vehicle's useful life. Ford Motor Company, however, urges you to have all recommended maintenance services performed at the specified intervals and to record all vehicle service.

**Hot climate oil change intervals:** Vehicles operating in the Middle East, North Africa, Sub-Saharan Africa or locations with similar climates using an American Petroleum Institute (API) Certified for Gasoline Engines (Certification mark) oil of SM or SN quality, the normal oil change interval is 5000 miles (8000 kilometers).

# Scheduled Maintenance

If the available API SM or SN oils are not available, then the oil change service interval is 3000 miles (4800 kilometers).

**Engine air filter and cabin air filter replacement:** Engine air filter and cabin air filter life is dependent on exposure to dusty and dirty conditions. Vehicles operated in these conditions require frequent inspection and replacement of the engine air filter and cabin air filter.

## Engine Coolant Change Record

**Initial change:** Six years or 100000 miles (160000 kilometers) (whichever comes first).

**After initial change:** Every three years or 50000 miles (80000 kilometers).

## Engine Coolant Change Log

<input type="radio"/> Repair Order #:	<p>Dealer stamp</p>
<input type="radio"/> Distance:	
<input type="radio"/> Engine hours (optional):	
<input type="radio"/> Multi-point inspection (recommended): <input type="checkbox"/>	
<input type="radio"/> Signature:	

<input type="radio"/> Repair Order #:	<p>Dealer stamp</p>
<input type="radio"/> Distance:	
<input type="radio"/> Engine hours (optional):	
<input type="radio"/> Multi-point inspection (recommended): <input type="checkbox"/>	
<input type="radio"/> Signature:	

# Scheduled Maintenance

<input type="radio"/> Repair Order #:	<p>Dealer stamp</p>
<input type="radio"/> Distance:	
<input type="radio"/> Engine hours (optional):	
<input type="radio"/> Multi-point inspection (recommended): <input type="checkbox"/>	
<input type="radio"/> Signature:	

<input type="radio"/> Repair Order #:	<p>Dealer stamp</p>
<input type="radio"/> Distance:	
<input type="radio"/> Engine hours (optional):	
<input type="radio"/> Multi-point inspection (recommended): <input type="checkbox"/>	
<input type="radio"/> Signature:	

<input type="radio"/> Repair Order #:	<p>Dealer stamp</p>
<input type="radio"/> Distance:	
<input type="radio"/> Engine hours (optional):	
<input type="radio"/> Multi-point inspection (recommended): <input type="checkbox"/>	
<input type="radio"/> Signature:	



# Index

## A

- A/C
  - See: Climate Control.....97
- About This Manual.....7
  - Protecting the Environment.....7
- ABS
  - See: Brakes.....134
- ABS driving hints
  - See: Hints on Driving With Anti-Lock Brakes.....134
- Accessories.....239
  - Exterior style.....239
  - Interior style.....239
  - Lifestyle.....239
  - Peace of mind.....239
- Accessories
  - See: Replacement Parts Recommendation.....9
- Adjusting the Headlamps.....188
  - Horizontal Aim Adjustment.....189
  - Vertical Aim Adjustment.....188
- Adjusting the Steering Wheel.....63
- Airbag Disposal.....42
- Air Conditioning
  - See: Climate Control.....97
- Air Vents.....97
  - Center Air Vents.....97
  - Side Air Vent.....97
- Alarm
  - See: Anti-Theft Alarm.....61
- Ambient Lighting.....71
- Anti-Theft Alarm.....61
  - Alarm System.....61
  - Arming the Alarm.....61
  - Disarming the Alarm.....61
  - Triggering the Alarm.....61
- Appendices.....356
- Audible Warnings and Indicators.....84
  - Automatic Transmission.....84
  - Headlamps On.....84
  - Key Outside Car.....84
  - Low Fuel.....84
  - Safety Belt Minder.....84
- Audio Control.....63
  - .....63
- Audio System.....244
  - General Information.....244
- Audio Troubleshooting.....258
- Audio unit - Vehicles With: AM/FM/CD/SYNC.....249
  - Alternative Frequencies.....253
  - Automatic Volume Control.....252
  - Autostore Control.....252
  - News Broadcasts.....253
  - Regional Mode.....253
  - Sound Button.....251
  - Station Preset Buttons.....252
  - Station Tuning Control.....252
  - Waveband Button.....252
- Audio unit - Vehicles With: AM/FM/CD.....245
  - Alternative Frequencies.....248
  - Automatic Volume Control.....248
  - Autostore Control.....248
  - News Broadcasts.....248
  - Regional Mode.....249
  - Sound Button.....247
  - Station Preset Buttons.....248
  - Station Tuning Control.....247
  - Waveband Button.....247
- Audio unit - Vehicles With: Sony Audio System/Touchscreen Display.....255
- Audio unit - Vehicles With: Touchscreen Display.....254
- Autolamps.....68
- Automatic Climate Control.....99
  - Temperature Control.....100
- Automatic Transmission.....128
  - Emergency Park Position Release Lever.....131
  - Hints on Driving with an Automatic Transmission.....131
  - Selector Lever Positions.....129
  - Sport Mode and Manual Shifting.....130
- Automatic Transmission Fluid
  - Check.....185
- Auxiliary Input Jack.....257
- Auxiliary Power Points.....111
  - 12 Volt DC Power Point.....111
  - Location.....111

## B

- Bonnet Lock
  - See: Opening and Closing the Hood.....177

# Index

Booster Seats.....	23	Checking the Wiper Blades.....	186
Types of Booster Seats.....	23	Child Restraint and Safety Belt Maintenance.....	32
Brake Fluid Check.....	185	Child Safety.....	14
Brakes.....	134	General Information.....	14
General Information.....	134	Child Safety Locks.....	25
Breaking-In.....	157	Left-Hand Side.....	25
Brakes and Clutch.....	157	Right-Hand Side.....	25
Engine.....	157	Child Seat Positioning.....	21
Tires.....	157	Cigar Lighter.....	111
Bulb Specification Chart.....	199	Cleaning Leather Seats.....	207
<b>C</b>		Cleaning Products.....	204
Cabin Air Filter.....	103	Cleaning the Alloy Wheels.....	208
California Proposition 65.....	12	Cleaning the Engine.....	205
Capacities and Specifications.....	235	Cleaning the Exterior.....	204
Cargo Nets.....	153	Cleaning Plastic Exterior Parts.....	205
Installing and Removing the Cargo Net.....	153	Exterior Chrome.....	204
Car Wash		Stripes or Graphics (if equipped).....	204
See: Cleaning the Exterior.....	204	Underbody.....	205
Changing a Bulb.....	190	Cleaning the Instrument Panel and Instrument Cluster Lens.....	207
Center High Mounted Stop Lamp.....	193	Cleaning the Interior.....	206
Front Fog Lamps.....	192	Cleaning the Windows and Wiper Blades.....	206
Headlamp.....	190	Clearing All MyKeys.....	49
Interior Lamp.....	194	Climate Control.....	97
License Plate Lamp.....	194	Principle of Operation.....	97
Luggage Compartment Lamp, Footwell Lamp and Liftgate Lamp.....	194	Clock.....	88
Reading Lamps.....	194	Type 1.....	88
Rear Lamps.....	192	Type 2.....	88
Side Direction Indicator.....	191	Cold Weather Precautions.....	157
Changing a Fuse.....	175	Coolant Check	
Fuses.....	175	See: Engine Coolant Check.....	183
Changing a Road Wheel.....	230	Crash Sensors and Airbag Indicator.....	41
Dissimilar Spare Wheel and Tire Assembly Information.....	230	Creating a MyKey.....	48
Stowing the flat tire.....	233	Programming or Changing Configurable Settings.....	49
Tire Change Procedure.....	231	Cruise Control.....	64
Changing the 12V Battery.....	186	Principle of Operation.....	142
Changing the Engine Air Filter.....	187	Cruise control	
Changing the Wiper Blades.....	186	See: Using Cruise Control.....	142
Rear Window Wiper Blade.....	186	Cup Holders.....	112
Windshield Wiper Blades.....	186	Customer Assistance.....	160
Checking MyKey System Status.....	49		
MyKey Distance.....	49		
Number of Admin Keys.....	50		
Number of MyKeys.....	49		

# Index

## D

Data Recording.....	10
Event Data Recording.....	10
Service Data Recording.....	10
Daytime Running Lamps.....	69
Direction Indicators.....	69
Driver and Passenger Airbags.....	35
Children and Airbags.....	35
Proper Driver and Front Passenger Seating Adjustment.....	35
Knee Airbag.....	39
Driving Aids.....	144
Driving Hints.....	157
Driving Through Water.....	157
DRL See: Daytime Running Lamps.....	69

## E

Economical Driving.....	157
Emission Control System.....	123
On-Board Diagnostics (OBD-II).....	124
Readiness for Inspection/Maintenance (I/M) Testing.....	124
End User License Agreement.....	356
SYNC® End User License Agreement (EULA).....	356
Engine Block Heater.....	116
Using the Engine Block Heater.....	117
Engine Coolant Check.....	183
Adding Engine Coolant.....	184
Checking the Engine Coolant.....	183
Recycled Engine Coolant.....	185
Severe Climates.....	185
Engine Immobilizer See: Passive Anti-Theft System.....	60
Engine Oil Check.....	182
Adding Engine Oil.....	182
Resetting the Oil Life Monitoring System.....	183
Engine Oil Dipstick - 1.0L EcoBoost™.....	182
Engine Oil Dipstick - 1.6L Duratec-16V Ti-VCT (88kW/120PS) - Sigma.....	182
Engine Oil Dipstick - 1.6L EcoBoost™.....	182

Engine Specifications.....	235
Drivebelt Routing.....	235
Entertainment.....	313
AM/FM Radio.....	315
Bluetooth Audio.....	331
Browsing Device Content.....	313
CD.....	326
SD Card Slot and USB Port.....	327
SIRIUS® Satellite Radio (If Activated).....	321
Supported Media Players, Formats and Metadata Information.....	330
Event Data Recording See: Data Recording.....	10
Export Unique Options.....	12
Exterior Mirrors.....	74
Fold-Away Exterior Mirrors.....	75
Integrated Blind Spot Mirrors.....	75
Power Exterior Mirrors.....	74

## F

Fastening the Safety Belts.....	27
Restraint of Pregnant Women.....	27
Safety Belt Extension Assembly.....	29
Safety Belt Locking Modes.....	28
Floor Mats.....	158
Fog Lamps - Front See: Front Fog Lamps.....	69
Ford Credit.....	117
(U.S. Only).....	12
Ford Extended Service Plan (ESP).....	241
SERVICE PLANS (CANADA ONLY).....	243
SERVICE PLANS (U.S. Only).....	241
Front Fog Lamps.....	69
Front Passenger Sensing System.....	36
Fuel and Refueling.....	118
Fuel Consumption.....	122
Calculating Fuel Economy.....	122
Filling the Tank.....	122
Fuel Filter.....	186
Fuel Quality.....	119
Choosing the Right Fuel (Flexible Fuel Vehicles).....	119
Choosing the Right Fuel (Gasoline Vehicles).....	119
Octane Recommendations.....	119
Fuel Shutoff.....	167



# Index

Fuses.....	169
Fuse Specification Chart.....	169
Engine Compartment Fuse Box.....	169
Passenger Compartment Fuse Box.....	172

## G

Gauges.....	77
Compass (If Equipped).....	77
Engine Coolant Temperature Gauge.....	78
Fuel Gauge.....	78
General Information on Radio	
Frequencies.....	43
Intelligent Access.....	43
Getting Assistance Outside the U.S. and Canada.....	163
Getting the Services You Need.....	160
Away From Home.....	160
Global Opening and Closing.....	73
Global Closing.....	74
Global Opening.....	73

## H

Handbrake	
See: Parking Brake.....	134
Hazard Warning Flashers.....	167
Headlamp Exit Delay.....	69
Head Restraints.....	105
Adjusting the Head Restraint.....	106
Heated Seats.....	109
Heated Windows and Mirrors.....	103
Heated Exterior Mirrors.....	103
Heated Windows.....	103
Heating	
See: Climate Control.....	97
Hill Start Assist.....	132
Switching the System On and Off.....	133
Using Hill Start Assist.....	132

Hints on Controlling the Interior	
Climate.....	100
Cooling the Interior Quickly.....	102
General Hints.....	100
Heating the Interior Quickly.....	101
Maximum Cooling Performance in Instrument Panel or Instrument Panel and Footwell Positions.....	103
Recommended Settings for Cooling .....	102
Recommended Settings for Heating.....	101
Side Window Defogging in Cold Weather.....	103
Vehicle Stationary for Extended Periods During Extreme High Ambient Temperatures.....	102
Hints on Driving With Anti-Lock Brakes.....	134
Hood Lock	
See: Opening and Closing the Hood.....	177

## I

Ignition Switch.....	113
In California (U.S. Only).....	161
Information Displays.....	85
General Information.....	85
Information.....	337
911 Assist.....	343
Alerts.....	343
Calendar.....	343
SIRIUS Travel Link.....	341
SYNC Services (If Equipped, United States Only).....	338
Vehicle Health Report.....	345
Information Messages.....	89
Installing Child Seats.....	15
Child Seats.....	15
Using Lap and Shoulder Belts.....	16
Using Lower Anchors and Tethers for Children (LATCH).....	18
Using Tether Straps.....	20
Instrument Cluster.....	77
Instrument Lighting Dimmer.....	68
Interior Lamps.....	70
Front Interior Lamps.....	70
Rear Interior Lamps.....	70
Interior Luggage Compartment Release.....	58

# Index

Interior Mirror.....	75	Locking and Unlocking.....	52
Auto-Dimming Mirror.....	76	Auto Lock Feature.....	53
Introduction.....	7	Auto Unlock Feature.....	54
<b>J</b>		Emergency Locking With the Key.....	54
Jump-Starting the Vehicle.....	167	Locking and Unlocking the Doors From Inside.....	52
To Connect the Booster Cables.....	168	Locking and Unlocking the Doors With the Key.....	52
To Start the Engine.....	168	Remote Control.....	52
<b>K</b>		Smart Unlocks for Integrated Keyhead Transmitter.....	53
Keyless Entry.....	56	Smart Unlocks for Intelligent Access Keys .....	53
Disabled Keys.....	57	Unlocking the Doors With the Interior Door Handles.....	53
General Information.....	56	Locks.....	52
Locking and Unlocking the Doors With the Key Blade.....	58	Luggage Covers.....	153
Locking Your Vehicle.....	56	Removing the Cover.....	153
Passive Key.....	56	Lug Nuts	
Unlocking Your Vehicle.....	57	See: Changing a Road Wheel.....	230
Keyless Starting.....	113	<b>M</b>	
Failure to Start.....	114	Maintenance.....	177
Ignition On.....	114	General Information.....	177
Starting with Automatic Transmission.....	114	Manual Climate Control.....	98
Starting with Manual Transmission.....	114	Manual Liftgate.....	55
Stopping the Engine When Your Vehicle is Moving.....	115	Opening and Closing the Liftgate.....	55
Stopping the Engine with Your Vehicle Stationary.....	115	Manual Seats.....	107
Keys and Remote Controls.....	43	Adjusting the Height of the Driver Seat.....	108
<b>L</b>		Adjusting the Lumbar Support.....	108
Lighting Control.....	67	Moving the Seat Backward and Forward.....	107
Headlamp Flasher.....	68	Recline Adjustment.....	108
High Beams.....	68	Manual Transmission - 1.6L	
Lighting Control Positions.....	67	EcoBoost™.....	127
Parking Lamps.....	67	Parking Your Vehicle.....	128
Lighting.....	67	Recommended Shift Speeds.....	127
General Information.....	67	Reverse.....	128
Load Carrying.....	145	Using the Clutch.....	127
General Information.....	145	Manual Transmission.....	126
Load Limit.....	145	Parking Your Vehicle.....	127
Vehicle Loading - with and without a Trailer.....	145	Recommended Shift Speeds.....	126
		Reverse.....	126
		Using the Clutch.....	126
		Message Center	
		See: Information Displays.....	85

# Index

Mirrors	
See: Heated Windows and Mirrors.....	103
See: Windows and Mirrors.....	72
Mobile Communications	
Equipment.....	10
Moonroof.....	76
Moonroof Sliding Shade.....	76
Opening and Closing the Moonroof.....	76
Venting the Moonroof.....	76
Motorcraft Parts.....	236
MyFord Touch™.....	295
General Information.....	295
MyKey Troubleshooting.....	50
MyKey™.....	48
Principle of Operation.....	48
<b>N</b>	
Navigation.....	346
cityseekr.....	348
Map Mode.....	351
Navigation Map Updates.....	353
Navigation Voice Commands.....	353
Point of Interest (POI) Categories.....	348
Quick-touch Buttons.....	352
Setting a Destination.....	346
Setting Your Navigation Preferences.....	349
<b>O</b>	
Oil Check	
See: Engine Oil Check.....	182
Opening and Closing the Hood.....	177
Closing the Hood.....	178
Opening the Hood.....	177
Ordering Additional Owner's Literature.....	164
Obtaining a French Owner's Manual.....	164
<b>P</b>	
Parking Aid.....	138
Rear Sensing System.....	139
Parking Aids.....	138
Principle of Operation.....	138
Parking Brake.....	134
All Vehicles.....	135
Vehicles With Automatic Transmission.....	134
Vehicles With Manual Transmission.....	134
Passive Anti-Theft System.....	60
SecuriLock®.....	60
PATS	
See: Passive Anti-Theft System.....	60
Perchlorate.....	12
Personalized Settings.....	89
Measure Units.....	89
Switching Chimes Off.....	89
Personal Safety System™.....	33
How Does the Personal Safety System Work?.....	33
Phone.....	331
Making Calls.....	333
Pairing Subsequent Phones.....	332
Pairing Your Phone for the First Time.....	332
Phone Menu Options.....	333
Phone Settings.....	335
Phone Voice Commands.....	336
Receiving Calls.....	333
Text Messaging.....	334
Power Door Locks	
See: Locking and Unlocking.....	52
Power Steering Fluid Check.....	185
Power Windows.....	72
Accessory Delay.....	73
Bounce-Back.....	72
One-Touch Down.....	72
One-Touch Up.....	72
Window Lock.....	72
<b>R</b>	
Rear Seats.....	108
Folding the Seatback.....	108
Unfolding the Seatback.....	109
Rear Under Floor Storage.....	152
Adjustable Load Floor.....	152
Rear View Camera.....	139
Switching the Rear View Camera Off.....	141
Switching the Rear View Camera On.....	140
Using the Display.....	140
Vehicles with Parking Aid.....	141

# Index

Rear View Camera	
See: Rear View Camera.....	139
Rear Window Wiper and Washers.....	66
Intermittent Wipe.....	66
Rear Window Washer.....	66
Reverse Gear Wipe.....	66
Refueling.....	120
Easy Fuel™ Capless Fuel System.....	121
Remote Control.....	43
Car Finder.....	47
Integrated Keyhead Transmitter.....	43
Intelligent Access Transmitter.....	44
Replacing the Battery.....	44
Reprogramming the Unlocking Function.....	44
Sounding a Panic Alarm.....	47
Removing a Headlamp.....	189
Repairing Minor Paint Damage.....	206
Replacement Parts	
Recommendation.....	9
Collision Repairs.....	9
Scheduled Maintenance and Mechanical Repairs.....	9
Warranty on Replacement Parts.....	10
Replacing a Lost Key or Remote Control.....	47
Reporting Safety Defects (Canada Only).....	165
Reporting Safety Defects (U.S. Only).....	164
Roadside Assistance.....	166
Vehicles Sold In Canada : Getting Roadside Assistance.....	166
Vehicles Sold In Canada : Using Roadside Assistance.....	166
Vehicles Sold In The U.S.: Getting Roadside Assistance.....	166
Vehicles Sold In The U.S. : Using Roadside Assistance.....	166
Roadside Emergencies.....	166
Running-In	
See: Breaking-In.....	157
Running Out of Fuel.....	119
Refilling with a Portable Fuel Container.....	120

## S

Safety Belt Height Adjustment.....	29
Safety Belt Minder.....	30
Belt-Minder®.....	30
Safety Belts.....	26
Principle of Operation.....	26
Safety Belt Warning Lamp and Indicator	
Chime.....	30
Conditions of operation.....	30
Safety Precautions.....	118
Scheduled Maintenance.....	371
Engine Coolant Change Record.....	384
Exceptions.....	383
General Maintenance Information.....	371
Normal Scheduled Maintenance.....	374
Special Operating Conditions.....	379
Seats.....	105
Security.....	60
Settings.....	303
Clock.....	303
Display.....	304
Settings.....	305
Sound.....	304
Vehicle.....	305
Side Airbags.....	38
Side Curtain Airbags.....	39
Sitting in the Correct Position.....	105
Snow Chains	
See: Using Snow Chains.....	226
Special Notices.....	12
New Vehicle Limited Warranty.....	12
Special Instructions.....	12
Speed Control	
See: Cruise Control.....	142
Stability Control.....	136
Principle of Operation.....	136
Starter Switch	
See: Ignition Switch.....	113
Starting a Gasoline Engine.....	115
Cold or Hot Engine.....	115
Engine Idle Speed after Starting.....	116
Failure to Start.....	116
Flooded Engine.....	116
Starting and Stopping the Engine.....	113
General Information.....	113
Steering.....	144
Electric Power Steering.....	144

# Index

Steering Wheel.....	63
Storage Compartments.....	112
Sunroof	
See: Moonroof.....	76
Supplementary Restraints System.....	34
Principle of Operation.....	34
Switching Off the Engine.....	116
Vehicles With a Turbocharger.....	116
Symbols Glossary.....	7
SYNC™ Applications and Services.....	274
911 Assist.....	274
SYNC AppLink.....	280
SYNC Services: Traffic, Directions & Information (TDI).....	277
Vehicle Health Report.....	276
SYNC™.....	259
General Information.....	259
SYNC™ Troubleshooting.....	289
<b>T</b>	
Tailgate	
See: Manual Liftgate.....	55
Technical Specifications - 1.0L	
EcoBoost™.....	200
Capacities.....	200
Specifications.....	200
Technical Specifications - 1.6L	
Duratec-16V Ti-VCT (Sigma).....	202
Capacities.....	202
Specifications.....	203
Technical Specifications - 1.6L	
EcoBoost™.....	201
Capacities.....	201
Specifications.....	201
Technical Specifications	
See: Capacities and Specifications.....	235
The Better Business Bureau (BBB) Auto Line Program (U.S. Only).....	162
Tire Care.....	211
Glossary of Tire Terminology.....	213
Information About Uniform Tire Quality Grading.....	211
Information Contained on the Tire	
Sidewall.....	214
Temperature A B C.....	212
Traction AA A B C.....	212
Treadwear.....	212
Tire Pressure Monitoring System.....	226
Changing Tires With a Tire Pressure Monitoring System.....	227
Understanding Your Tire Pressure Monitoring System.....	227
Tires	
See: Wheels and Tires.....	211
Towing a Trailer - 1.6L EcoBoost™.....	154
Towing the Vehicle on Four Wheels.....	154
Emergency Towing.....	154
Recreational Towing.....	155
Towing.....	154
Transmission Code Designation.....	238
Transmission.....	126
Transmission	
See: Transmission.....	126
Transporting the Vehicle.....	154
Trip Computer.....	88
.....	88
<b>U</b>	
Under Hood Overview - 1.0L	
EcoBoost™.....	179
Under Hood Overview - 1.6L Duratec-16V Ti-VCT (88kW/120PS) - Sigma.....	180
Under Hood Overview - 1.6L	
EcoBoost™.....	181
Using Cruise Control.....	142
Switching Cruise Control Off.....	143
Switching Cruise Control On.....	142
Using MyKey With Remote Start Systems.....	50
Using Snow Chains.....	226
Using Stability Control - 1.6L	
EcoBoost™.....	137
Switching Sport Mode On.....	137
Switching the System Off.....	137
Using Stability Control.....	137
.....	137

# Index

Using SYNC™ With Your Media Player.....	281
Accessing Your Play Menu.....	285
Connecting Your Digital Media Player to the USB Port.....	281
Media Menu Features.....	283
Media Voice Commands.....	281
System Settings.....	287
What's Playing?.....	281
Using SYNC™ With Your Phone.....	263
Accessing Features through the Phone Menu.....	267
Accessing Your Phone Settings.....	270
Making Calls.....	266
Pairing a Phone for the First Time.....	264
Pairing Subsequent Phones.....	264
Phone Options during an Active Call.....	266
Phone Voice Commands.....	264
Receiving Calls.....	266
System Settings.....	271
Text Messaging.....	269
Using Voice Recognition.....	261
Initiating a Voice Session.....	261
System Interaction and Feedback.....	262
Using Winter Tires.....	226
Utilizing the Mediation/Arbitration Program (Canada Only).....	162
<b>V</b>	
Vehicle Care.....	204
Vehicle Certification Label.....	237
Vehicle Identification Number.....	237
Vehicle Storage.....	208
Battery.....	209
Body.....	209
Brakes.....	209
Cooling system.....	209
Engine.....	209
Fuel system.....	209
General.....	208
Miscellaneous.....	209
Removing Vehicle From Storage.....	209
Tires.....	209
Ventilation	
See: Climate Control.....	97
Vents	
See: Air Vents.....	97
VIN	
See: Vehicle Identification Number.....	237
Voice Control.....	64
<b>W</b>	
Warning Lamps and Indicators - 1.6L	
EcoBoost™.....	81
Anti-lock Braking System Warning Lamp.....	81
Brake System Warning Lamp.....	81
Cruise Control Indicator.....	81
Direction Indicator.....	82
Door Ajar Warning Lamp.....	82
Engine Coolant Temperature Warning Lamp.....	82
Engine Oil Warning Lamp.....	82
Engine Warning Lamps.....	82
Front Airbag Warning Lamp.....	83
Front Fog Lamps Indicator.....	83
Headlamp Indicator.....	83
High Beam Indicator.....	83
Ignition Warning Lamp.....	83
Information Indicator.....	83
Low Fuel Level Warning Lamp.....	83
Low Tire Pressure Warning.....	83
Safety Belt Minder Warning Lamp.....	83
Service Engine Soon.....	83
Shift Indicator.....	84

# Index

---

Warning Lamps and Indicators.....	78
Anti-lock Braking System Warning Lamp.....	78
Brake System Warning Lamp.....	78
Cruise Control Indicator.....	78
Direction Indicator.....	79
Door Ajar Warning Lamp.....	79
Engine Coolant Temperature Warning Lamp.....	79
Engine Oil Warning Lamp.....	79
Engine Warning Lamps.....	79
Front Airbag Warning Lamp.....	80
Front Fog Lamps Indicator.....	80
Headlamp Indicator.....	80
High Beam Indicator.....	80
Ignition Warning Lamp.....	80
Information Indicator.....	80
Low Fuel Level Warning Lamp.....	80
Low Tire Pressure Warning.....	80
Safety Belt Minder Warning Lamp.....	80
Service Engine Soon.....	80
Shift Indicator.....	81
Stability Control Indicator.....	81
Washer Fluid Check.....	186
Washers	
See: Cleaning the Exterior.....	204
See: Wipers and Washers.....	65
Waxing.....	205
Wheel Nuts	
See: Changing a Road Wheel.....	230
Wheels and Tires.....	211
General Information.....	211
Technical Specifications.....	234
Windows and Mirrors.....	72
Windshield Washers.....	65
Windshield Wipers.....	65
Intermittent Wipe.....	65
Speed Dependent Wipers.....	65
Winter Tires	
See: Using Winter Tires.....	226
Wipers and Washers.....	65

