

2016 **EXPLORER** Owner's Manual



owner.ford.com



ford.ca

February 2016  
Third Printing  
Owner's Manual  
Explorer  
Litho in U.S.A.



GL2J19A321 AB



The information contained in this publication was correct at the time of going to print. In the interest of continuous development, we reserve the right to change specifications, design or equipment at any time without notice or obligation. No part of this publication may be reproduced, transmitted, stored in a retrieval system or translated into any language in any form by any means without our written permission. Errors and omissions excepted.

© Ford Motor Company 2016

All rights reserved.

Part Number: 03/2015 20160119104843



# Table of Contents

---

## Introduction

|  |    |
|--|----|
| About This Manual.....                   | 7  |
| Symbols Glossary.....                    | 7  |
| Data Recording.....                      | 9  |
| California Proposition 65.....           | 11 |
| Perchlorate.....                         | 11 |
| Ford Credit.....                         | 11 |
| Replacement Parts<br>Recommendation..... | 11 |
| Special Notices.....                     | 12 |
| Mobile Communications<br>Equipment.....  | 13 |
| Export Unique Options.....               | 13 |

## Environment

|                                 |    |
|---------------------------------|----|
| Protecting the Environment..... | 14 |
|---------------------------------|----|

## Child Safety

|                                  |    |
|----------------------------------|----|
| General Information.....         | 15 |
| Child Seats.....                 | 16 |
| Installing Child Restraints..... | 17 |
| Booster Seats.....               | 26 |
| Child Restraint Positioning..... | 28 |
| Child Safety Locks.....          | 29 |

## Seatbelts

|   |    |
|---|----|
| Principle of Operation.....                       | 31 |
| Fastening the Seatbelts.....                      | 32 |
| Seatbelt Height Adjustment.....                   | 36 |
| Seatbelt Warning Lamp and Indicator<br>Chime..... | 36 |
| Seatbelt Reminder.....                            | 37 |
| Child Restraint and Seatbelt<br>Maintenance.....  | 38 |

## Personal Safety System™

|                              |    |
|------------------------------|----|
| Personal Safety System™..... | 39 |
|------------------------------|----|

## Supplementary Restraints System

|   |    |
|---|----|
| Principle of Operation.....             | 40 |
| Driver and Passenger Airbags.....       | 41 |
| Front Passenger Sensing System.....     | 42 |
| Side Airbags.....                       | 44 |
| Passenger Knee Airbag.....              | 45 |
| Safety Canopy™.....                     | 45 |
| Crash Sensors and Airbag Indicator..... | 46 |
| Airbag Disposal.....                    | 47 |

## Keys and Remote Controls

|  |    |
|--|----|
| Principle of Operation.....                      | 48 |
| General Information on Radio<br>Frequencies..... | 48 |
| Remote Control.....                              | 49 |
| Replacing a Lost Key or Remote<br>Control.....   | 53 |

## MyKey™

|   |    |
|---|----|
| Principle of Operation.....                   | 54 |
| Creating a MyKey.....                         | 55 |
| Clearing All MyKeys.....                      | 56 |
| Checking MyKey System Status.....             | 57 |
| Using MyKey With Remote Start<br>Systems..... | 58 |
| MyKey Troubleshooting.....                    | 58 |

## Locks

|                            |    |
|----------------------------|----|
| Locking and Unlocking..... | 60 |
| Manual Liftgate.....       | 63 |
| Power Liftgate.....        | 64 |
| Keyless Entry.....         | 67 |

## Security

|                                |    |
|--------------------------------|----|
| Passive Anti-Theft System..... | 69 |
| Anti-Theft Alarm.....          | 70 |

# Table of Contents

---

## Steering Wheel

|  |    |
|--|----|
| Adjusting the Steering Wheel - Vehicles<br>With: Manual Adjustable Steering<br>Column..... | 71 |
| Adjusting the Steering Wheel - Vehicles<br>With: Power Adjustable Steering<br>Column.....  | 71 |
| Audio Control.....   | 72 |
| Voice Control.....   | 73 |
| Cruise Control.....  | 73 |
| Information Display Control.....   | 74 |
| Heated Steering Wheel.....   | 74 |

## Pedals

|                           |    |
|---------------------------|----|
| Adjusting the Pedals..... | 75 |
|---------------------------|----|

## Wipers and Washers

|                                    |    |
|------------------------------------|----|
| Windshield Wipers.....             | 76 |
| Autowipers.....                    | 76 |
| Windshield Washers.....            | 77 |
| Rear Window Wiper and Washers..... | 77 |

## Lighting

|                                  |    |
|----------------------------------|----|
| General Information.....         | 79 |
| Lighting Control.....            | 79 |
| Autolamps.....                   | 80 |
| Instrument Lighting Dimmer.....  | 81 |
| Headlamp Exit Delay.....         | 81 |
| Daytime Running Lamps.....       | 81 |
| Automatic High Beam Control..... | 82 |
| Front Fog Lamps.....             | 83 |
| Direction Indicators.....        | 84 |
| Interior Lamps.....              | 84 |

## Windows and Mirrors

|                       |    |
|-----------------------|----|
| Power Windows.....    | 86 |
| Exterior Mirrors..... | 87 |
| Interior Mirror.....  | 89 |
| Sun Visors.....       | 89 |
| Moonroof.....         | 90 |

## Instrument Cluster

|                                      |    |
|--------------------------------------|----|
| Gauges.....                          | 91 |
| Warning Lamps and Indicators.....    | 94 |
| Audible Warnings and Indicators..... | 98 |

## Information Displays

|                           |     |
|---------------------------|-----|
| General Information.....  | 99  |
| Information Messages..... | 113 |

## Climate Control

|  |     |
|--|-----|
| Manual Climate Control.....  | 127 |
| Automatic Climate Control - Vehicles<br>With: Premium AM/FM/CD.....  | 128 |
| Automatic Climate Control - Vehicles<br>With: Sony Audio System..... | 130 |
| Hints on Controlling the Interior<br>Climate.....                    | 132 |
| Rear Passenger Climate Controls.....                                 | 134 |
| Heated Windows and Mirrors.....                                      | 135 |
| Cabin Air Filter.....  | 135 |
| Remote Start.....  | 136 |

## Seats

|                                      |     |
|--------------------------------------|-----|
| Sitting in the Correct Position..... | 137 |
| Head Restraints.....                 | 137 |
| Manual Seats.....                    | 140 |
| Power Seats.....                     | 141 |
| Memory Function.....                 | 143 |
| Rear Seats.....                      | 144 |
| Heated Seats.....                    | 151 |
| Climate Controlled Seats.....        | 152 |

## Universal Garage Door Opener

|                                   |     |
|-----------------------------------|-----|
| Universal Garage Door Opener..... | 154 |
|-----------------------------------|-----|

## Auxiliary Power Points

|                             |     |
|-----------------------------|-----|
| Auxiliary Power Points..... | 159 |
|-----------------------------|-----|

# Table of Contents

---

## Storage Compartments

|                       |     |
|-----------------------|-----|
| Center Console.....   | 161 |
| Overhead Console..... | 161 |

## Starting and Stopping the Engine

|                                 |     |
|---------------------------------|-----|
| General Information.....        | 162 |
| Ignition Switch.....            | 162 |
| Keyless Starting.....           | 162 |
| Starting a Gasoline Engine..... | 163 |
| Engine Block Heater.....        | 166 |

## Fuel and Refueling

|                                  |     |
|----------------------------------|-----|
| Safety Precautions.....          | 168 |
| Fuel Quality.....                | 169 |
| Fuel Quality - E85.....          | 169 |
| Fuel Filler Funnel Location..... | 170 |
| Running Out of Fuel.....         | 170 |
| Refueling.....                   | 171 |
| Fuel Consumption.....            | 173 |
| Emission Control System.....     | 174 |

## Transmission

|                             |     |
|-----------------------------|-----|
| Automatic Transmission..... | 177 |
|-----------------------------|-----|

## Four-Wheel Drive

|                             |     |
|-----------------------------|-----|
| Principle of Operation..... | 180 |
| Using Four-Wheel Drive..... | 180 |

## Brakes

|   |     |
|---|-----|
| General Information.....                    | 185 |
| Hints on Driving With Anti-Lock Brakes..... | 185 |
| Parking Brake.....                          | 186 |
| Hill Start Assist.....                      | 186 |

## Traction Control

|                             |     |
|-----------------------------|-----|
| Principle of Operation..... | 188 |
| Using Traction Control..... | 188 |

## Stability Control

|                              |     |
|------------------------------|-----|
| Principle of Operation.....  | 189 |
| Using Stability Control..... | 190 |

## Terrain Response

|                                 |     |
|---------------------------------|-----|
| Using Terrain Response.....     | 191 |
| Using Hill Descent Control..... | 192 |

## Parking Aids

|                             |     |
|-----------------------------|-----|
| Principle of Operation..... | 194 |
| Rear Parking Aid.....       | 194 |
| Front Parking Aid.....      | 195 |
| Side Sensing System.....    | 196 |
| Active Park Assist.....     | 198 |
| Rear View Camera.....       | 203 |
| 180 Degree Camera.....      | 206 |

## Cruise Control

|                                    |     |
|------------------------------------|-----|
| Principle of Operation.....        | 208 |
| Using Cruise Control.....          | 208 |
| Using Adaptive Cruise Control..... | 209 |

## Driving Aids

|                                    |     |
|------------------------------------|-----|
| Driver Alert.....                  | 215 |
| Lane Keeping System.....           | 215 |
| Blind Spot Information System..... | 219 |
| Cross Traffic Alert.....           | 222 |
| Steering.....                      | 225 |
| Pre-Collision Assist.....          | 226 |

## Load Carrying

|                                   |     |
|-----------------------------------|-----|
| Rear Under Floor Storage.....     | 229 |
| Cargo Nets.....                   | 229 |
| Luggage Covers.....               | 230 |
| Roof Racks and Load Carriers..... | 230 |
| Load Limit.....                   | 231 |

## Towing

|                       |     |
|-----------------------|-----|
| Towing a Trailer..... | 239 |
|-----------------------|-----|



# Table of Contents

|   |     |
|---|-----|
| Trailer Sway Control.....   | 240 |
| Recommended Towing Weights.....   | 240 |
| Essential Towing Checks.....  | 242 |
| Transporting the Vehicle.....   | 244 |
| Towing the Vehicle on Four Wheels -<br>2.3L EcoBoost™.....              | 245 |
| Towing the Vehicle on Four Wheels -<br>3.5L Duratec/3.5L EcoBoost™..... | 246 |

## Driving Hints

|                            |     |
|----------------------------|-----|
| Breaking-In.....           | 248 |
| Economical Driving.....    | 248 |
| Driving Through Water..... | 249 |
| Floor Mats.....            | 249 |

## Roadside Emergencies

|                                |     |
|--------------------------------|-----|
| Roadside Assistance.....       | 251 |
| Hazard Warning Flashers.....   | 252 |
| Fuel Shutoff.....              | 252 |
| Jump Starting the Vehicle..... | 253 |
| Post-Crash Alert System.....   | 255 |

## Customer Assistance

|  |     |
|--|-----|
| Getting the Services You Need.....                                     | 256 |
| In California (U.S. Only).....   | 257 |
| The Better Business Bureau (BBB) Auto<br>Line Program (U.S. Only)..... | 258 |
| Utilizing the Mediation/Arbitration<br>Program (Canada Only).....      | 259 |
| Getting Assistance Outside the U.S. and<br>Canada.....                 | 259 |
| Ordering Additional Owner's<br>Literature.....                         | 260 |
| Reporting Safety Defects (U.S.<br>Only).....                           | 261 |
| Reporting Safety Defects (Canada<br>Only).....                         | 261 |

## Fuses

|                               |     |
|-------------------------------|-----|
| Fuse Specification Chart..... | 263 |
| Changing a Fuse.....          | 271 |

## Maintenance

|  |     |
|--|-----|
| General Information.....   | 273 |
| Opening and Closing the Hood.....  | 273 |
| Under Hood Overview - 2.3L<br>EcoBoost™.....                             | 275 |
| Under Hood Overview - 3.5L<br>EcoBoost™.....                             | 276 |
| Under Hood Overview - 3.5L<br>Duratec.....                               | 277 |
| Engine Oil Dipstick - 2.3L<br>EcoBoost™.....                             | 278 |
| Engine Oil Dipstick - 3.5L Duratec/3.5L<br>EcoBoost™.....                | 278 |
| Engine Oil Check.....  | 278 |
| Oil Change Indicator Reset.....  | 279 |
| Engine Coolant Check.....  | 280 |
| Automatic Transmission Fluid Check -<br>2.3L EcoBoost™.....              | 283 |
| Automatic Transmission Fluid Check -<br>3.5L Duratec/3.5L EcoBoost™..... | 284 |
| Brake Fluid Check.....   | 285 |
| Power Steering Fluid Check.....  | 286 |
| Washer Fluid Check.....  | 286 |
| Fuel Filter.....   | 286 |
| Changing the 12V Battery.....  | 286 |
| Checking the Wiper Blades.....   | 288 |
| Changing the Wiper Blades.....   | 288 |
| Adjusting the Headlamps.....   | 289 |
| Removing a Headlamp.....   | 291 |
| Changing a Bulb.....   | 291 |
| Bulb Specification Chart.....  | 294 |
| Changing the Engine Air Filter.....                                      | 296 |

## Vehicle Care

|   |     |
|---|-----|
| General Information.....                      | 297 |
| Cleaning Products.....                        | 297 |
| Cleaning the Exterior.....                    | 297 |
| Waxing.....                                   | 298 |
| Cleaning the Engine.....                      | 299 |
| Cleaning the Windows and Wiper<br>Blades..... | 299 |

# Table of Contents

|   |     |   |     |
|---|-----|---|-----|
| Cleaning the Interior.....  | 300 | Audio Unit - Vehicles With: AM/FM/CD/<br>SYNC.....    | 352 |
| Cleaning the Instrument Panel and<br>Instrument Cluster Lens..... | 300 | Audio Unit - Vehicles With: Premium AM/<br>FM/CD..... | 355 |
| Cleaning Leather Seats.....                                       | 301 | Audio Unit - Vehicles With: Sony AM/FM/<br>CD.....    | 356 |
| Repairing Minor Paint Damage.....                                 | 301 | Digital Radio.....                                    | 360 |
| Cleaning the Alloy Wheels.....                                    | 301 | Satellite Radio.....                                  | 362 |
| Vehicle Storage.....  | 302 | USB Port.....   | 365 |
|   |     | Media Hub.....  | 365 |
| <b>Wheels and Tires</b>   |     | <b>SYNC™</b>  |     |
| General Information.....  | 304 | General Information.....                              | 366 |
| Tire Care.....  | 307 | Using Voice Recognition.....                          | 368 |
| Using Summer Tires.....   | 320 | Using SYNC™ With Your Phone.....                      | 370 |
| Using Snow Chains.....  | 320 | SYNC™ Applications and Services.....                  | 382 |
| Tire Pressure Monitoring System.....                              | 321 | Using SYNC™ With Your Media<br>Player.....            | 387 |
| Changing a Road Wheel.....  | 325 | SYNC™ Troubleshooting.....                            | 396 |
| Technical Specifications.....                                     | 330 |   |     |
| <b>Capacities and Specific-<br/>ations</b>                        |     | <b>MyFord Touch™</b>                                  |     |
| Engine Specifications - 2.3L<br>EcoBoost™.....                    | 331 | General Information.....                              | 404 |
| Engine Specifications - 3.5L<br>Duratec.....                      | 332 | Settings.....   | 414 |
| Engine Specifications - 3.5L<br>EcoBoost™.....                    | 332 | Entertainment.....                                    | 427 |
| Motorcraft Parts - 2.3L EcoBoost™.....                            | 333 | Phone.....  | 443 |
| Motorcraft Parts - 3.5L Duratec.....                              | 334 | Information.....                                      | 450 |
| Motorcraft Parts - 3.5L EcoBoost™.....                            | 335 | Climate.....  | 460 |
| Vehicle Identification Number.....                                | 336 | Navigation.....                                       | 464 |
| Vehicle Certification Label.....                                  | 337 | MyFord Touch™ Troubleshooting.....                    | 472 |
| Transmission Code Designation.....                                | 337 | <b>Accessories</b>                                    |     |
| Capacities and Specifications - 2.3L<br>EcoBoost™.....            | 338 | Accessories.....                                      | 479 |
| Capacities and Specifications - 3.5L<br>Duratec.....              | 341 | <b>Extended Service Plan<br/>(ESP)</b>                |     |
| Capacities and Specifications - 3.5L<br>EcoBoost™.....            | 346 | Extended Service Plan (ESP).....                      | 481 |
| <b>Audio System</b>   |     | <b>Scheduled Maintenance</b>                          |     |
| General Information.....  | 351 | General Maintenance Information.....                  | 483 |
|   |     | Normal Scheduled Maintenance.....                     | 486 |



# Table of Contents

---

|   |     |
|---|-----|
| Special Operating Conditions Scheduled Maintenance..... | 489 |
| Scheduled Maintenance Record.....                       | 491 |

## **Appendices**

|                                 |     |
|---------------------------------|-----|
| End User License Agreement..... | 502 |
| Type Approvals.....             | 523 |

# Introduction

## ABOUT THIS MANUAL

Thank you for choosing Ford. We recommend that you take some time to get to know your vehicle by reading this manual. The more that you know about your vehicle, the greater the safety and pleasure you will get from driving it.

### WARNING



Driving while distracted can result in loss of vehicle control, crash and injury. We strongly recommend that you use extreme caution when using any device that may take your focus off the road. Your primary responsibility is the safe operation of your vehicle. We recommend against the use of any hand-held device while driving and encourage the use of voice-operated systems when possible. Make sure you are aware of all applicable local laws that may affect the use of electronic devices while driving.

**Note:** This manual describes product features and options available throughout the range of available models, sometimes even before they are generally available. It may describe options not fitted to the vehicle you have purchased.

**Note:** Some of the illustrations in this manual may show features as used in different models, so may appear different to you on your vehicle.

**Note:** Always use and operate your vehicle in line with all applicable laws and regulations.

**Note:** Pass on this manual when selling your vehicle. It is an integral part of your vehicle.

This manual may qualify the location of a component as left-hand side or right-hand side. The side is determined when facing forward in the seat.



E154903

A Right-hand side.

B Left-hand side.

## SYMBOLS GLOSSARY

These are some of the symbols you may see on your vehicle.



Safety alert



See Owner's Manual



Air conditioning system



Anti-lock braking system



Avoid smoking, flames or sparks



Battery



Battery acid



Brake fluid - non petroleum based

# Introduction

---



Brake system



Cabin air filter



Check fuel cap



Child safety door lock or unlock



Child seat lower anchor



Child seat tether anchor



Cruise control



Do not open when hot



Engine air filter



Engine coolant



Engine coolant temperature



Engine oil



Explosive gas



Fan warning



Fasten seatbelt



Front airbag



Front fog lamps



Fuel pump reset



Fuse compartment



Hazard warning flashers



Heated rear window



Heated windshield



Interior luggage compartment release



Jack



Keep out of reach of children



Lighting control



Low tire pressure warning



Maintain correct fluid level



Note operating instructions



Panic alarm

# Introduction



Parking aid



Parking brake



Power steering fluid



Power windows front/rear



Power window lockout



Service engine soon



Side airbag



Shield the eyes



Stability control



Windshield wash and wipe

## DATA RECORDING

### Service Data Recording

Service data recorders in your vehicle are capable of collecting and storing diagnostic information about your vehicle. This potentially includes information about the performance or status of various systems and modules in the vehicle, such as engine, throttle, steering or brake systems. In order to properly diagnose and service your vehicle, Ford Motor Company, Ford of Canada, and service and repair

facilities may access or share among them vehicle diagnostic information received through a direct connection to your vehicle when diagnosing or servicing your vehicle. Additionally, when your vehicle is in for service or repair, Ford Motor Company, Ford of Canada, and service and repair facilities may access or share among them data for vehicle improvement purposes. For U.S. only (if equipped), if you choose to use the SYNC Vehicle Health Report, you consent that certain diagnostic information may also be accessed electronically by Ford Motor Company and Ford authorized service facilities, and that the diagnostic information may be used for any purpose. See **SYNC™** (page 366).

### Event Data Recording

**This vehicle is equipped with an event data recorder. The main purpose of an event data recorder is to record, in certain crash or near crash-like situations, such as an airbag deployment or hitting a road obstacle; this data will assist in understanding how a vehicle's systems performed. The event data recorder is designed to record data related to vehicle dynamics and safety systems for a short period of time, typically 30 seconds or less.**

**The event data recorder in this vehicle is designed to record such data as:**

- **How various systems in your vehicle were operating;**
- **Whether or not the driver and passenger safety belts were buckled/fastened;**
- **How far (if at all) the driver was depressing the accelerator and/or the brake pedal; and**
- **How fast the vehicle was traveling; and**
- **Where the driver was positioning the steering wheel.**

# Introduction

---

**This data can help provide a better understanding of the circumstances in which crashes and injuries occur.**

**Note:** *Event data recorder data is recorded by your vehicle only if a non-trivial crash situation occurs; no data is recorded by the event data recorder under normal driving conditions and no personal data or information (e.g., name, gender, age, and crash location) is recorded (see limitations regarding 911 Assist and Traffic, directions and Information privacy below). However, parties, such as law enforcement, could combine the event data recorder data with the type of personally identifying data routinely acquired during a crash investigation.*

**To read data recorded by an event data recorder, special equipment is required, and access to the vehicle or the event data recorder is needed. In addition to the vehicle manufacturer, other parties, such as law enforcement, that have such special equipment, can read the information if they have access to the vehicle or the event data recorder. Ford Motor Company and Ford of Canada do not access event data recorder information without obtaining consent, unless pursuant to court order or where required by law enforcement, other government authorities or other third parties acting with lawful authority. Other parties may seek to access the information independently of Ford Motor Company and Ford of Canada.**

**Note:** *Including to the extent that any law pertaining to Event Data Recorders applies to SYNC or its features, please note the following: Once 911 Assist (if equipped) is enabled (set ON), 911 Assist may, through any paired and connected cell phone, disclose to emergency services that the vehicle has been in a crash involving the deployment of an airbag or, in certain vehicles, the activation of the fuel pump shut-off. Certain versions or updates to 911 Assist may also be capable of being used to electronically or verbally provide to 911 operators the vehicle location (such as latitude and longitude), and/or other details about the vehicle or crash or personal information about the occupants to assist 911 operators to provide the most appropriate emergency services. If you do not want to disclose this information, do not activate the 911 Assist feature. See SYNC™ (page 366).*

**Additionally, when you connect to Traffic, Directions and Information (if equipped, U.S. only), the service uses GPS technology and advanced vehicle sensors to collect the vehicle's current location, travel direction, and speed ("vehicle travel information"), only to help provide you with the directions, traffic reports, or business searches that you request. If you do not want Ford or its vendors to receive this information, do not activate the service. For more information, see Traffic, Directions and Information, Terms and Conditions. See SYNC™ (page 366).**

# Introduction

## CALIFORNIA PROPOSITION 65

### WARNINGS



Some constituents of engine exhaust, certain vehicle components, certain fluids contained in vehicles and certain products of component wear contain or emit chemicals known to the State of California to cause cancer and birth defects or other reproductive harm.



Battery posts, terminals and related accessories contain lead and lead compounds, chemicals known to the State of California to cause cancer and reproductive harm. Batteries also contain other chemicals known to the State of California to cause cancer. Wash your hands after handling.

## PERCHLORATE

Certain components in your vehicle such as airbag modules, seatbelt pretensioners and remote control batteries may contain perchlorate material. Special handling may apply for service or vehicle end of life disposal.

### For more information visit:

| Web Address  |
|--|
| <a href="http://www.dtsc.ca.gov/hazardouswaste/perchlorate">www.dtsc.ca.gov/hazardouswaste/perchlorate</a> |

## FORD CREDIT

### US Only

Ford Credit offers a full range of financing and lease plans to help you acquire your vehicle. If you have financed or leased your vehicle through Ford Credit, thank you for your business.

We offer a number of convenient ways for you to contact us and help to manage your account.

Call 1-800-727-7000.

For more information about Ford Credit and access to the Account Manager, go to [www.fordcredit.com](http://www.fordcredit.com).

## REPLACEMENT PARTS RECOMMENDATION

We have built your vehicle to the highest standards using quality parts. We recommend that you demand the use of genuine Ford and Motorcraft parts whenever your vehicle requires scheduled maintenance or repair. You can clearly identify genuine Ford and Motorcraft parts by looking for the Ford, FoMoCo or Motorcraft branding on the parts or their packaging.

### Scheduled Maintenance and Mechanical Repairs

One of the best ways for you to make sure that your vehicle provides years of service is to have it maintained in line with our recommendations using parts that conform to the specifications detailed in this Owner's Manual. Genuine Ford and Motorcraft parts meet or exceed these specifications.

### Collision Repairs

We hope that you never experience a collision, but accidents do happen. Genuine Ford replacement collision parts meet our stringent requirements for fit, finish, structural integrity, corrosion protection and dent resistance. During

# Introduction

---

vehicle development we validate that these parts deliver the intended level of protection as a whole system. A great way to know for sure you are getting this level of protection is to use genuine Ford replacement collision parts.

## Warranty on Replacement Parts

Genuine Ford and Motorcraft replacement parts are the only replacement parts that benefit from a Ford Warranty. The Ford Warranty may not cover damage caused to your vehicle as a result of failed non-Ford parts. For additional information, refer to the terms and conditions of the Ford Warranty.

## SPECIAL NOTICES

### New Vehicle Limited Warranty

For a detailed description of what is covered and what is not covered by your vehicle's New Vehicle Limited Warranty, refer to the Warranty Manual that is provided to you along with your Owner's Manual.

### Special Instructions

For your added safety, your vehicle is fitted with sophisticated electronic controls.

#### WARNINGS



You risk death or serious injury to yourself and others if you do not follow the instruction highlighted by the warning symbol. Failure to follow the specific warnings and instructions could result in personal injury.



**Never** place front seat mounted rear-facing child or infant seats in front of an active passenger airbag.

---

## On Board Diagnostics Data Link Connector

#### WARNING



Use of wireless plug-in devices in the OBD Data Link Connector (DLC) may allow unauthorized third parties to gain access to vehicle systems and data which could impair the function of various vehicle systems, including safety-related systems. The DLC should only be used by a repair facility that operates in accordance with Ford's service and repair instructions.

---

Your vehicle has an OBD Data Link Connector (DLC) that is used in conjunction with a diagnostic scan tool for vehicle diagnostics, repairs and reprogramming services. Installing an aftermarket device that uses the DLC during normal driving for purposes such as remote insurance company monitoring, transmission of vehicle data to other devices or entities, or altering the performance of the vehicle, may cause interference with or even damage to vehicle systems. We do not recommend or endorse the use of aftermarket plug-in devices unless approved by Ford. The vehicle Warranty will not cover damage caused by an aftermarket plug-in device.

## Notice to Owners of Pickup Trucks and Utility Type Vehicles

#### WARNING



Utility vehicles have a significantly higher rollover rate than other types of vehicles.

---

Before you drive your vehicle, please read this Owner's Guide carefully. Your vehicle is not a passenger car. As with other vehicles of this type, failure to operate this vehicle correctly may result in loss of vehicle control, vehicle rollover, personal injury or death.



# Introduction

---

## Using Your Vehicle With a Snowplow

### Do not use this vehicle for snowplowing.

Your vehicle is not equipped with a snowplowing package.

## Using Your Vehicle as an Ambulance

### Do not use this vehicle as an ambulance.

Your vehicle is not equipped with the Ford Ambulance Preparation Package.

## MOBILE COMMUNICATIONS EQUIPMENT

### WARNING



Driving while distracted can result in loss of vehicle control, crash and injury. We strongly recommend that you use extreme caution when using any device that may take your focus off the road. Your primary responsibility is the safe operation of your vehicle. We recommend against the use of any hand-held device while driving and encourage the use of voice-operated systems when possible. Make sure you are aware of all applicable local laws that may affect the use of electronic devices while driving.

---

Using mobile communications equipment is becoming increasingly important in the conduct of business and personal affairs. However, you must not compromise your own or others' safety when using such equipment. Mobile communications can enhance personal safety and security when appropriately used, particularly in emergency situations. Safety must be paramount when using mobile

communications equipment to avoid negating these benefits. Mobile communication equipment includes, but is not limited to, cellular phones, pagers, portable email devices, text messaging devices and portable two-way radios.

## EXPORT UNIQUE OPTIONS

For your particular global region, your vehicle may be equipped with features and options that are different from the features and options that are described in this Owner's Manual. A market unique supplement may be supplied that complements this book. By referring to the market unique supplement, if provided, you can properly identify those features, recommendations and specifications that are unique to your vehicle. This Owner's Manual is written primarily for the U.S. and Canadian Markets. Features or equipment listed as standard may be different on units built for Export. **Refer to this Owner's Manual for all other required information and warnings.**

# Environment

---

## **PROTECTING THE ENVIRONMENT**

You must play your part in protecting the environment. Correct vehicle usage and the authorized disposal of waste, cleaning and lubrication materials are significant steps toward this aim.

# Child Safety

---

## GENERAL INFORMATION

See the following sections for directions on how to properly use safety restraints for children.

### WARNINGS



Always make sure your child is secured properly in a device that is appropriate for their height, age and weight. Child safety restraints must be bought separately from your vehicle. Failure to follow these instructions and guidelines may result in an increased risk of serious injury or death to your child.



All children are shaped differently. The recommendations for safety restraints are based on probable child height, age and weight thresholds from the National Highway Traffic Safety Administration and other safety organizations, or are the minimum requirements of law. We recommend checking with a NHTSA Certified Child Passenger Safety Technician (CPST) and

### WARNINGS

consult your pediatrician to make sure your child seat is appropriate for your child, and is compatible with and properly installed in your vehicle. To locate a child seat fitting station and CPST, contact NHTSA toll free at 1-888-327-4236 or go to <http://www.nhtsa.dot.gov>. In Canada, contact Transport Canada toll free at 1-800-333-0371 or go to [www.tc.gc.ca](http://www.tc.gc.ca) to find a Child Car Seat Clinic in your area. Failure to properly restrain children in safety seats made especially for their height, age, and weight may result in an increased risk of serious injury or death to your child.



Do not leave children or animals unattended in the vehicle. On hot days, the temperature in the trunk or vehicle interior can rise very quickly. Exposure of people or animals to these high temperatures for even a short time can cause death or serious heat-related injuries, including brain damage. Small children are particularly at risk.

---

# Child Safety

## Recommendations for Safety Restraints for Children

| Child               | Child size, height, weight, or age  | Recommended restraint type   |
|---------------------|---|--|
| Infants or toddlers | Children weighing 40 lb (18 kg) or less (generally age four or younger).  | Use a child safety seat (sometimes called an infant carrier, convertible seat, or toddler seat).   |
| Small children      | Children who have outgrown or no longer properly fit in a child safety seat (generally children who are less than 4 ft. 9 in. (1.45 m) tall, are greater than age four and less than age 12, and between 40 lb (18 kg) and 80 lb (36 kg) and upward to 100 lb (45 kg) if recommended by your child restraint manufacturer). | Use a belt-positioning booster seat.   |
| Larger children     | Children who have outgrown or no longer properly fit in a belt-positioning booster seat (generally children who are at least 4 ft. 9 in. (1.45 m) tall or greater than 80 lb (36 kg) or 100 lb (45 kg) if recommended by child restraint manufacturer).   | Use a vehicle safety belt having the lap belt snug and low across the hips, shoulder belt centered across the shoulder and chest, and seat back upright. |

- You are required by law to properly use safety seats for infants and toddlers in the United States and Canada.
- Many states and provinces require that small children use approved booster seats until they reach age eight, a height of 4 feet 9 inches (1.45 meters) tall, or 80 pounds (36 kilograms). Check your local and state or provincial laws for specific requirements about the safety of children in your vehicle.
- When possible, always properly restrain children 12 years of age and under in a rear seating position of your vehicle. Accident statistics suggest that children are safer when properly restrained in the rear seating positions than in a front seating position. See **Front Passenger Sensing System** (page 42).

## CHILD SEATS



E142594

# Child Safety

Use a child safety seat (sometimes called an infant carrier, convertible seat, or toddler seat) for Infants, toddlers or children weighing 40 pounds (18 kilograms) or less (generally age four or younger)

## INSTALLING CHILD RESTRAINTS

### Using Lap and Shoulder Belts

#### WARNINGS



Airbags can kill or injure a child in a child seat. Never place a rear-facing child seat in front of an active airbag.

If you must use a forward-facing child seat in the front seat, move the seat upon which the child seat is installed all the way back.



Airbags can kill or injure a child in a child seat. Children 12 and under should be properly restrained in the rear seat whenever possible.



Depending on where you secure a child restraint, and depending on the child restraint design, you may block access to certain seatbelt buckle assemblies and LATCH lower anchors, rendering those features potentially unusable. To avoid risk of injury, occupants should only use seating positions where they are able to be properly restrained.

When installing a child safety seat with combination lap and shoulder belts:

- Use the correct seatbelt buckle for that seating position.
- Insert the belt tongue into the proper buckle until you hear a snap and feel it latch. Make sure the tongue is securely fastened in the buckle.
- Keep the buckle release button pointing up and away from the safety seat, with the tongue between the child seat and the release button, to prevent accidental unbuckling.
- Place the vehicle seat upon which the child seat will be installed in the upright position.
- For second-row seating positions, adjust the recliner slightly to improve child seat fit. If needed, remove the head restraints.
- For third-row seating positions, stow the head restraints to improve child seat fit. See **Head Restraints** (page 137).
- Put the seatbelt in the automatic locking mode. See Step 5. This vehicle does not require the use of a locking clip.

Perform the following steps when installing the child seat with combination lap and shoulder belts:

**Note:** *Although the child seat illustrated is a forward facing child seat, the steps are the same for installing a rear facing child seat.*

**Note:** *The lock-off device on some child restraints may not accommodate the shoulder portion of the inflatable seatbelt. Follow all instructions provided by the manufacturer of the child restraint regarding the necessary and proper use of the lock-off device. In some instances these devices have been provided only for use in vehicles with seatbelt systems that would otherwise require a locking clip.*

# Child Safety

## Standard seatbelts



E142528

1. Position the child safety seat in a seat with a combination lap and shoulder belt.



E142529

2. After positioning the child safety seat in the proper seating position, pull down on the shoulder belt and then grasp the shoulder belt and lap belt together behind the belt tongue.



E142530

3. While holding the shoulder and lap belt portions together, route the tongue through the child seat according to the child seat manufacturer's instructions. Be sure the belt webbing is not twisted.

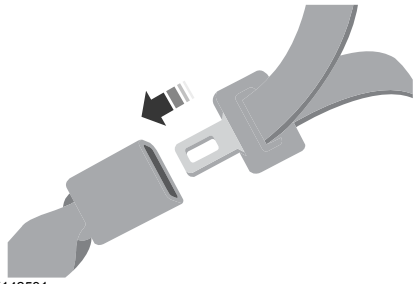

E142531

4. Insert the belt tongue into the proper buckle (the buckle closest to the direction the tongue is coming from) for that seating position until you hear a snap and feel the latch engage. Make sure the tongue is latched securely by pulling on it.

# Child Safety



E142875

5. To put the retractor in the automatic locking mode, grasp the shoulder portion of the belt and pull downward until all of the belt is pulled out.

**Note:** The automatic locking mode is available on the front passenger and rear seats.

6. Allow the belt to retract to remove slack. The belt will click as it retracts to indicate it is in the automatic locking mode.
7. Try to pull the belt out of the retractor to make sure the retractor is in the automatic locking mode (you should not be able to pull more belt out). If the retractor is not locked, unbuckle the belt and repeat Steps 5 and 6.



E142533

8. Remove remaining slack from the belt. Force the seat down with extra weight, for example, by pressing down or kneeling on the child restraint while pulling up on the shoulder belt in order to force slack from the belt. This is necessary to remove the remaining slack that will exist once the extra weight of the child is added to the child restraint. It also helps to achieve the proper snugness of the child seat to your vehicle. Sometimes, a slight lean toward the buckle will provide extra help to remove remaining slack from the belt.
9. Attach the tether strap (if the child seat is equipped).



E142534

10. Before placing the child in the seat, forcibly move the seat forward and back to make sure the seat is securely held in place. To check this, grab the seat at the belt path and attempt to move it side to side and forward and back. There should be no more than 1 inch (2.5 centimeters) of movement for proper installation.

We recommend checking with a NHTSA Certified Child Passenger Safety Technician to make certain the child restraint is properly installed. In Canada, check with Transport Canada for referral to a Child Car Seat Clinic.



# Child Safety

## Inflatable seatbelts



E142528

1. Position the child safety seat in a seat with a combination lap and shoulder belt.



E142530

3. While holding the shoulder and lap belt portions together, route the tongue through the child seat according to the child seat manufacturer's instructions. Be sure the belt webbing is not twisted.



E146522

2. After positioning the child safety seat in the proper seating position, grasp the shoulder belt and lap belt together behind the belt tongue.

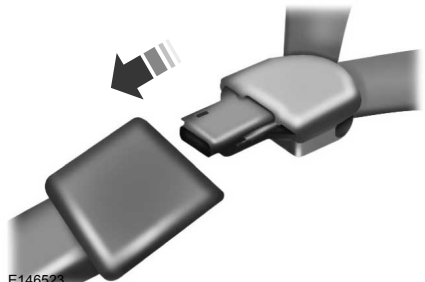

E146523

4. Insert the belt tongue into the proper buckle (the buckle closest to the direction the tongue is coming from) for that seating position until you hear a snap and feel the latch engage. Make sure the tongue is latched securely by pulling on it.

# Child Safety

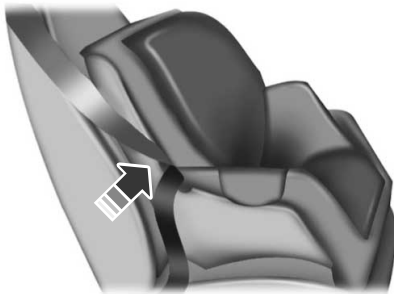

E146524

5. To put the retractor in the automatic locking mode, grasp the lap portion of the inflatable seatbelt and pull upward until all of the belt is pulled out.

**Note:** The automatic locking mode is available on the front passenger and rear seats.

**Note:** Unlike the standard seatbelt, the inflatable seatbelt's unique lap portion locks the child seat for installation. The ability for the shoulder portion of the belt to move freely is normal, even after the lap belt has been put into the automatic locking mode.

**Note:** The lock-off device on some child restraints may not accommodate the shoulder portion of the inflatable seatbelt. Follow all instructions provided by the manufacturer of the child restraint regarding the necessary and proper use of the lock-off device. In some instances, these devices have been provided only for use in vehicles with seatbelt systems that would otherwise require a locking clip.

6. Allow the belt to retract to remove slack. The belt will click as it retracts to indicate it is in the automatic locking mode.

7. Try to pull the belt out of the retractor to make sure the retractor is in the automatic locking mode (you should not be able to pull more belt out). If the retractor is not locked, unbuckle the belt and repeat Steps 5 and 6.

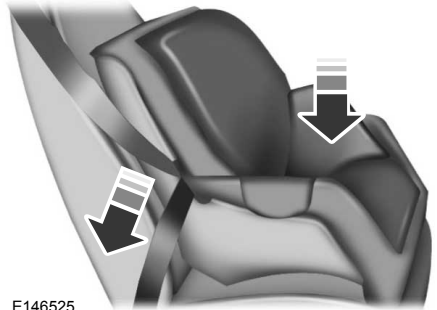

E146525

8. Remove remaining slack from the belt. Force the seat down with extra weight, for example, by pressing down or kneeling on the child restraint while pulling down on the lap belt in order to force slack from the belt. This is necessary to remove the remaining slack that will exist once the extra weight of the child is added to the child restraint. It also helps to achieve the proper snugness of the child seat to your vehicle. Sometimes, a slight lean toward the buckle will additionally help to remove remaining slack from the belt.
9. Attach the tether strap (if the child seat is equipped).

# Child Safety

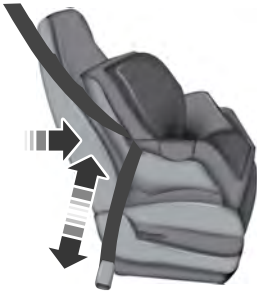

E142534

10. Before placing the child in the seat, forcibly move the seat forward and back to make sure the seat is securely held in place. To check this, grab the seat at the belt path and attempt to move it side to side and forward and back. There should be no more than 1 inch (2.5 centimeters) of movement for proper installation.

We recommend checking with a NHTSA Certified Child Passenger Safety Technician to make certain the child restraint is properly installed. In Canada, check with Transport Canada for referral to a Child Car Seat Clinic.

## Using Lower Anchors and Tethers for Children (LATCH)

### WARNINGS



Never attach two child safety seats to the same anchor. In a crash, one anchor may not be strong enough to hold two child safety seat attachments and may break, causing serious injury or death.

### WARNINGS



Depending on where you secure a child restraint, and depending on the child restraint design, you may block access to certain seatbelt buckle assemblies or LATCH lower anchors, rendering those features potentially unusable. To avoid risk of injury, occupants should only use seating positions where they are able to be properly restrained.

The LATCH system is composed of three vehicle anchor points: two lower anchors located where the seatback and seat cushion meet (called the seat bight) and one top tether anchor located behind that seating position.

LATCH compatible child safety seats have two rigid or webbing mounted attachments that connect to the two lower anchors at the LATCH equipped seating positions in your vehicle. This type of attachment method eliminates the need to use seatbelts to attach the child seat, however the seatbelt can still be used to attach the child seat. For forward-facing child seats, the top tether strap must also be attached to the proper top tether anchor, if a top tether strap has been provided with your child seat.

Your vehicle has LATCH lower anchors for child seat installation at the seating positions marked with the child seat symbol.

### Second-row bucket seats and third-row passenger side

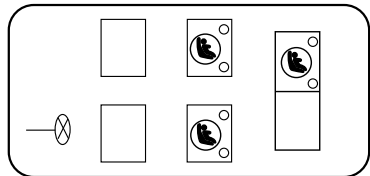

E190825

# Child Safety

## Second-row bench seats and third-row passenger side

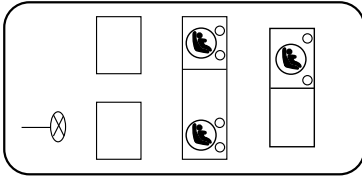

E190826



E144054

The LATCH anchors are located at the rear section of the rear seat between the cushion and seatback below the symbols as shown. Follow the child seat manufacturer's instructions to properly install a child seat with LATCH attachments.

Follow the instructions on attaching child safety seats with tether straps. See Using Tether Straps later in this chapter.

Attach LATCH lower attachments of the child seat only to the anchors shown.

## Use of Inboard Lower Anchors from the Outboard Seating Positions (Center Seating Use)

### WARNING



The standardized spacing for LATCH lower anchors is 11 inches (28 centimeters) center to center. Do not use LATCH lower anchors for the center seating position unless the child seat manufacturer's instructions permit and specify using anchors spaced at least as far apart as those in this vehicle.

The lower anchors at the center of the second row bench seat are spaced 20.5 inches (52 centimeters) apart. The standardized spacing for LATCH lower anchors is 11 inches (28 centimeters) center to center. A child seat with rigid LATCH attachments cannot be installed at the center seating position. LATCH compatible child seats (with attachments on belt webbing) can only be used at this seating position provided that the child seat manufacturer's instructions permit use with the anchor spacing stated. Do not attach a child seat to any lower anchor if an adjacent child seat is attached to that anchor.

Each time you use the safety seat, check that the seat is properly attached to the lower anchors and tether anchor, if applicable. Tug the child seat from side to side and forward and back where it is secured to your vehicle. The seat should move less than one inch when you do this for a proper installation.

If the safety seat is not anchored properly, the risk of a child being injured in a crash greatly increases.

# Child Safety

## Combining Seatbelt and LATCH Lower Anchors for Attaching Child Safety Seats

When used in combination, either the seatbelt or the LATCH lower anchors may be attached first, provided a proper installation is achieved. Attach the tether strap afterward, if included with the child seat.

## Using Tether Straps



Many forward-facing child safety seats include a tether strap which extends from the back of the child safety seat and hooks to an anchoring point called the top tether anchor. Tether straps are available as an accessory for many older safety seats.

Contact the manufacturer of your child seat for information about ordering a tether strap, or to obtain a longer tether strap if the tether strap on your safety seat does not reach the appropriate top tether anchor in your vehicle.

Once the child safety seat has been installed using either the seatbelt, the lower anchors of the LATCH system, or both, you can attach the top tether strap.

The tether strap anchors in your vehicle are in the following positions (shown from top view):

## Second row bucket seats and third row passenger side

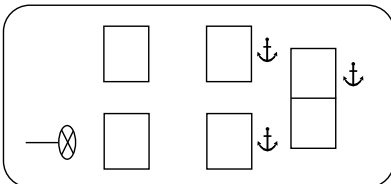

E190827

## Second row bench seats and third row passenger side

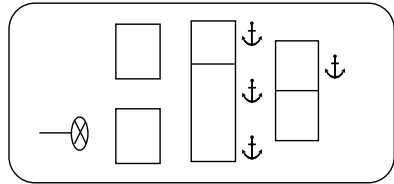

E190828

Perform the following steps to install a child safety seat with tether anchors:

**Note:** If you install a child seat with rigid LATCH attachments, do not tighten the tether strap enough to lift the child seat off your vehicle seat cushion when the child is seated in it. Keep the tether strap just snug without lifting the front of the child seat. Keeping the child seat just touching your vehicle seat gives the best protection in a severe crash.



E190829

# Child Safety

## Placement of the tether strap

- Second row outboard seat positions: Route the child safety seat tether strap over the seatback, under the head restraint and between the head restraint posts. If needed, remove the head restraint to improve the fit of the child safety seat or tether strap.
  - Second row center seat positions: Route the child safety seat tether strap over the top of the head restraint. If needed, remove the head restraint to improve the fit of the child safety seat or tether strap. See **Head Restraints** (page 137).
  - Third row seat position: Route the child safety seat tether strap over the seat back, under the head restraint and between the head restraint posts. If needed, fold the head restraint down to improve the fit of the child safety seat or tether strap. See **Head Restraints** (page 137).
1. Route the tether strap.
  2. Locate the correct anchor for the selected seating position.
  3. Clip the tether strap to the anchor as shown. The tether hook may be twisted  $\frac{1}{2}$  turn to improve installation. If the tether strap is clipped incorrectly, the child safety seat may not be retained properly in the event of a crash.



E190833

4. Tighten the child safety seat tether strap according to the manufacturer's instructions.

If the safety seat is not anchored properly, the risk of a child being injured in a crash greatly increases.

If your child restraint system is equipped with a tether strap, and the child restraint manufacturer recommends its use, we also recommend its use.

## Second row bucket (40/40)

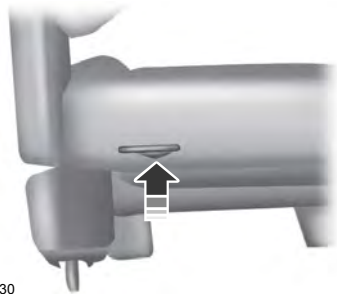

E190830

# Child Safety

## Second row bench (60/40)



E190831

## Third row seat

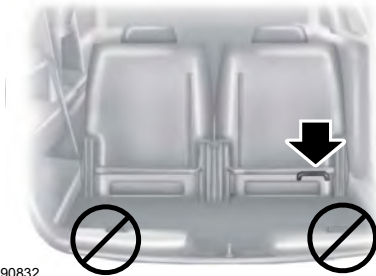

E190832

**Note:** The cargo tie downs at the rear edge of the floor are not tether anchors.

## BOOSTER SEATS

### WARNING



Never place, or allow a child to place, the shoulder belt under a child's arm or behind the back because it reduces the protection for the upper part of the body and may increase the risk of injury or death in a crash.

**Note:** Some booster seat safety belt guides may not accommodate the shoulder portion of the inflatable safety belt.

Use a belt-positioning booster seat for children who have outgrown or no longer properly fit in a child safety seat (generally children who are less than 4 feet 9 inches (1.45 meters) tall, are greater than age four (4) and less than age twelve (12), and between 40 pounds (18 kilograms) and 80 pounds (36 kilograms) and upward to 100 pounds (45 kilograms) if recommended by your child restraint manufacturer). Many state and provincial laws require that children use approved booster seats until they reach age eight, a height of 4 feet 9 inches (1.45 meters) tall, or 80 pounds (36 kilograms).

Booster seats should be used until you can answer YES to ALL of these questions when seated without a booster seat:

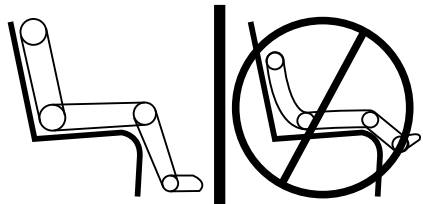

E142595



# Child Safety

- Can the child sit all the way back against their vehicle seat back with knees bent comfortably at the edge of the seat cushion?
- Can the child sit without slouching?
- Does the lap belt rest low across the hips?
- Is the shoulder belt centered on the shoulder and chest?
- Can the child stay seated like this for the whole trip?

Always use booster seats in conjunction with your vehicle lap and shoulder belt.

## Types of Booster Seats



E68924

- Backless booster seats

If your backless booster seat has a removable shield, remove the shield. If a vehicle seating position has a low seat back or no head restraint, a backless booster seat may place your child's head (as measured at the tops of the ears) above the top of the seat. In this case, move the backless booster to another seating position with a higher seat back or head restraint and lap and shoulder belts, or consider using a high back booster seat.



E70710

- High back booster seats

If, with a backless booster seat, you cannot find a seating position that adequately supports your child's head, a high back booster seat would be a better choice.

Children and booster seats vary in size and shape. Choose a booster that keeps the lap belt low and snug across the hips, never up across the stomach, and lets you adjust the shoulder belt to cross the chest and rest snugly near the center of the shoulder. The following drawings compare the ideal fit (center) to a shoulder belt uncomfortably close to the neck and a shoulder belt that could slip off the shoulder. The drawings also show how the lap belt should be low and snug across the child's hips.

# Child Safety



E142596



E142597

If the booster seat slides on the vehicle seat upon which it is being used, placing a rubberized mesh sold as shelf or carpet liner under the booster seat may improve this condition. Do not introduce any item thicker than this under the booster seat. Check with the booster seat manufacturer's instructions.

## CHILD RESTRAINT POSITIONING

### WARNINGS



Airbags can kill or injure a child in a child seat. Never place a rear-facing child seat in front of an active airbag. If you must use a forward-facing child seat in the front seat, move the vehicle seat upon which the child seat is installed all

### WARNINGS

the way back. When possible, all children age 12 and under should be properly restrained in a rear seating position. If all children cannot be seated and restrained properly in a rear seating position, properly restrain the largest child in the front seat.



Always carefully follow the instructions and warnings provided by the manufacturer of any child restraint to determine if the restraint device is appropriate for your child's size, height, weight, or age. Follow the child restraint manufacturer's instructions and warnings provided for installation and use in conjunction with the instructions and warnings provided by your vehicle

# Child Safety

## WARNINGS

manufacturer. A safety seat that is improperly installed or utilized, is inappropriate for your child's height, age, or weight or does not properly fit the child may increase the risk of serious injury or death.



Never let a passenger hold a child on his or her lap while your vehicle is moving. The passenger cannot protect the child from injury in a crash, which may result in serious injury or death.



Never use pillows, books, or towels to boost a child. They can slide around and increase the likelihood of injury or death in a crash.

## WARNINGS



Always restrain an unoccupied child seat or booster seat. These objects may become projectiles in a crash or sudden stop, which may increase the risk of serious injury.



Never place, or allow a child to place, the shoulder belt under a child's arm or behind the back because it reduces the protection for the upper part of the body and may increase the risk of injury or death in a crash.



To avoid risk of injury, do not leave children or pets unattended in your vehicle.

## Recommendations for attaching child safety restraints for children

| Restraint Type            | Combined weight of child and child seat | Use any attachment method as indicated below by X |                            |                                   |   |                  |
|---------------------------|---|---|----------------------------|-----------------------------------|---|------------------|
|                           |   | LATCH (lower anchors and top tether anchor)       | LATCH (lower anchors only) | Safety belt and top tether anchor | Safety belt and LATCH (lower anchors and top tether anchor) | Safety belt only |
| Rear facing child seat    | Up to 65 lb (29.5 kg)                   |   | X                          |                                   |   | X                |
| Rear facing child seat    | Over 65 lb (29.5 kg)                    |   |                            |                                   |   | X                |
| Forward facing child seat | Up to 65 lb (29.5 kg)                   | X   |                            | X                                 | X   |                  |
| Forward facing child seat | Over 65 lb (29.5 kg)                    |   |                            | X                                 | X   |                  |

**Note:** The child seat must rest tightly against the vehicle seat upon which it is installed. It may be necessary to lift or remove the head restraint. See **Seats** (page 137).

## CHILD SAFETY LOCKS

When these locks are set, the rear doors cannot be opened from the inside.

# Child Safety

---



E112197

The childproof locks are located on the rear edge of each rear door and must be set separately for each door.

## **Left-Hand Side**

Turn counterclockwise to lock and clockwise to unlock.

## **Right-Hand Side**

Turn clockwise to lock and counterclockwise to unlock.

# Seatbelts

## PRINCIPLE OF OPERATION

### WARNINGS



Always drive and ride with your seatback upright and the lap belt snug and low across the hips.



To reduce the risk of injury, make sure children sit where they can be properly restrained.



Never let a passenger hold a child on his or her lap while your vehicle is moving. The passenger cannot protect the child from injury in a crash.



All occupants of your vehicle, including the driver, should always properly wear their safety belts, even when an airbag supplemental restraint system is provided. Failure to properly wear your safety belt could seriously increase the risk of injury or death.



It is extremely dangerous to ride in a cargo area, inside or outside of a vehicle. In a crash, people riding in these areas are more likely to be seriously injured or killed. Do not allow people to ride in any area of your vehicle that is not equipped with seats and safety belts. Be sure everyone in your vehicle is in a seat and using a safety belt properly.



In a rollover crash, an unbelted person is significantly more likely to die than a person wearing a safety belt.



Each seating position in your vehicle has a specific safety belt assembly which is made up of one buckle and one tongue that are designed to be used as a pair. 1) Use the shoulder belt on the outside shoulder only. Never wear the shoulder belt under the arm. 2) Never swing the safety belt around your neck over the inside shoulder. 3) Never use a single belt for more than one person.

### WARNINGS



When possible, all children 12 years old and under should be properly restrained in a rear seating position. Failure to follow this could seriously increase the risk of injury or death.



Safety belts and seats can become hot in a vehicle that has been closed up in sunny weather; they could burn a small child. Check seat covers and buckles before you place a child anywhere near them.



Front and rear seat occupants, including pregnant women, should wear safety belts for optimum protection in an accident.

All seating positions in your vehicle have lap and shoulder safety belts. All occupants of the vehicle should always properly wear their safety belts, even when an airbag supplemental restraint system is provided.

The safety belt system consists of:

- Lap and shoulder safety belts.
- Shoulder safety belt with automatic locking mode, (except driver safety belt and rear inflatable safety belt).
- Height adjuster at the front outboard seating positions.
- Safety belt pretensioner at the front outboard seating positions.
- Belt tension sensor at the front outboard passenger seating position.



- Safety belt warning light and chime.



- Crash sensors and monitoring system with readiness indicator.

# Seatbelts

The safety belt pretensioners and rear inflatable safety belts are designed to activate in frontal, near-frontal and side crashes, and in rollovers. The safety belt pretensioners at the front seating positions are designed to tighten the safety belts firmly against the occupant's body when activated. This helps increase the effectiveness of the safety belts. In frontal crashes, the safety belt pretensioners can be activated alone or, if the crash is of sufficient severity, together with the front airbags.

## FASTENING THE SEATBELTS

**Standard belts shown, inflatable belts similar**

The front outboard and rear safety restraints in the vehicle are combination lap and shoulder belts.



E142587

1. Insert the belt tongue into the proper buckle (the buckle closest to the direction the tongue is coming from) until you hear a snap and feel it latch. Make sure you securely fasten the tongue in the buckle.

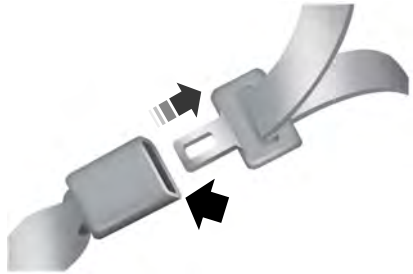

E142588

2. To unfasten, press the release button and remove the tongue from the buckle.

## Using Safety Belts During Pregnancy

### WARNING



Always ride and drive with your seatback upright and the safety belt properly fastened. The lap portion of the safety belt should fit snug and be positioned low across the hips. The shoulder portion of the safety belt should be positioned across the chest. Pregnant women should also follow this practice. See the following figure.

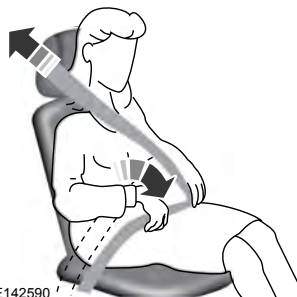

E142590

# Seatbelts

---

Pregnant women should always wear their safety belt. The lap belt portion of a combination lap and shoulder belt should be positioned low across the hips below the belly and worn as tight as comfort will allow. The shoulder belt should be positioned to cross the middle of the shoulder and the center of the chest.

## Safety Belt Locking Modes

### WARNINGS



After any vehicle crash, the safety belt system at all passenger seating positions must be checked by an authorized dealer to verify that the automatic locking retractor feature for child seats is still functioning properly. In addition, all safety belts should be checked for proper function.



Belt and retractor assembly must be replaced if the safety belt assembly automatic locking retractor feature or any other safety belt function is not operating properly when checked by an authorized dealer. Failure to replace the belt and retractor assembly could increase the risk of injury in crashes.

---

All safety restraints in the vehicle are combination lap and shoulder belts. The driver safety belt has the vehicle sensitive locking mode. The front outboard passenger and rear seat safety belts have both the vehicle sensitive locking mode and the automatic locking mode.

## Vehicle Sensitive Mode

This is the normal retractor mode, which allows free shoulder belt length adjustment to your movements and locking in response to vehicle movement. For example, if the driver brakes suddenly or turns a corner sharply, or the vehicle receives an impact of about 5 mph (8 km/h) or more, the combination safety belts will lock to help reduce forward movement of the driver and passengers.

In addition, the retractor is designed to lock if the webbing is pulled out too quickly. If this occurs, let the belt retract slightly and pull webbing out again in a slow and controlled manner.

## Automatic Locking Mode

In this mode, the shoulder belt is automatically pre-locked. The belt will still retract to remove any slack in the shoulder belt. The automatic locking mode is not available on the driver safety belt.

## When to Use the Automatic Locking Mode

This mode should be used any time a child safety seat, except a booster, is installed in passenger front or rear seating positions. Children 12 years old and under should be properly restrained in a rear seating position whenever possible. See **Child Safety** (page 15).

## How to Use the Automatic Locking Mode

### Non-inflatable safety belts

# Seatbelts



E142591

1. Buckle the combination lap and shoulder belt.
2. Grasp the shoulder portion and pull downward until the entire belt is pulled out. As the belt retracts, you will hear a clicking sound. This indicates the safety belt is now in the automatic locking mode.

## Rear outboard inflatable safety belts (second row only—if equipped)



E146363

1. Buckle the combination lap and shoulder belt.
2. Grasp the lap portion of the belt and pull upward until the entire belt is pulled out.

3. Allow the belt to retract. As the belt retracts, you will hear a clicking sound. This indicates the safety belt is now in the automatic locking mode.

## How to Disengage the Automatic Locking Mode

Unbuckle the combination lap and shoulder belt and allow it to retract completely to disengage the automatic locking mode and activate the vehicle sensitive (emergency) locking mode.

## Rear Inflatable Safety Belt (if Equipped)

### WARNING



Do not attempt to service, repair, or modify the rear inflatable safety belt.

The rear inflatable safety belts are fitted in the shoulder portion of the safety belts of the second-row outboard seating positions.

**Note:** *The rear inflatable safety belts are compatible with most infant and child safety car seats and belt positioning booster seats when properly installed. This is because they are designed to fill with a cooled gas at a lower pressure and at a slower rate than traditional airbags. After inflation, the shoulder portion of the safety belt remains cool to the touch.*

The rear inflatable safety belt consists of the following:

- An inflatable bag located in the shoulder safety belt webbing.
- Lap safety belt webbing with automatic locking mode.
- The same warning light, electronic control and diagnostic unit as used for the front safety belts.
- Impact sensors located in various parts of the vehicle.



# Seatbelts

## How does the rear inflatable safety belt system work?

The rear inflatable safety belts will function like standard restraints in everyday usage.



E146364

During a crash of sufficient force, the inflatable belt will inflate from inside the webbing.



E146365

The fully inflated belt's increased diameter more effectively holds the occupant in the appropriate seating position, and spreads crash forces over more area of the body than regular safety belts. This helps reduce pressure on the chest and helps control head and neck motion for passengers.

## WARNING



If the rear inflatable safety belt has deployed, it will not function again. The rear inflatable safety belt system must be replaced by an authorized dealer.

The rear inflatable safety belts are designed to inflate in frontal or near-frontal crashes and some side impact crashes. The fact that the rear inflatable safety belt did not inflate in a crash does not mean that something is wrong with the system. Rather, it means the forces were not of the type sufficient to cause activation.

## Safety Belt Extension Assembly

### WARNINGS



Do not use extensions to change the fit of the shoulder belt across the torso.



Do not use extensions with an inflatable safety belt.

If the safety belt is too short when fully extended, a safety belt extension assembly can be obtained from an authorized dealer.

Use only extensions manufactured by the same supplier as the safety belt. Manufacturer identification is on a label located either at the end of the webbing or on the retractor behind the trim. Also, use the safety belt extension only if the safety belt is too short for you when fully extended.

# Seatbelts

## SEATBELT HEIGHT ADJUSTMENT

### WARNING



Position the seatbelt height adjuster so that the belt rests across the middle of your shoulder. Failure to adjust the seatbelt properly could reduce the effectiveness of the seatbelt and increase the risk of injury in a crash.



E146191

## Conditions of operation

| If...   | Then...   |
|---|---|
| The driver's safety belt is not buckled before the ignition switch is turned to the on position...                | The safety belt warning light illuminates 1-2 minutes and the warning chime sounds 4-8 seconds. |
| The driver's safety belt is buckled while the indicator light is illuminated and the warning chime is sounding... | The safety belt warning light and warning chime turn off.                                       |
| The driver's safety belt is buckled before the ignition switch is turned to the on position...                    | The safety belt warning light and indicator chime remain off.                                   |

To adjust the shoulder belt height, squeeze the button and slide the height adjuster up or down. Release the button and pull down on the height adjuster to make sure it is locked in place.

## SEATBELT WARNING LAMP AND INDICATOR CHIME



This lamp illuminates and an audible warning will sound if the driver's safety belt has not been fastened when the vehicle's ignition is turned on.

# Seatbelts

## SEATBELT REMINDER

### Belt-Minder™

This feature supplements the safety belt warning function by providing additional reminders that intermittently sound a tone and illuminate the safety belt warning light when you are in the driver seat or you have a front seat passenger and a safety belt is unbuckled.

The system uses information from the front passenger sensing system to determine if a front seat passenger is present and therefore potentially in need of a warning. To avoid the system turning on the Belt-Minder feature for objects you place on the front passenger seat, only the front seat passengers receive warnings as determined by the front passenger sensing system.

If the Belt-Minder warnings expire (warnings for about five minutes) for one passenger (driver or front passenger), the other passenger can still cause the Belt-Minder feature to turn on.

| <b>If...</b>  | <b>Then...</b>   |
|---|--|
| You and the front seat passenger buckle your safety belts before you switch the ignition on or less than 1–2 minutes elapse after you switch the ignition on...   | The Belt-Minder feature will not activate.   |
| You or the front seat passenger do not buckle your safety belts before your vehicle reaches at least 6 mph (9.7 km/h) and 1–2 minutes elapse after you switch the ignition on...                                | The Belt-Minder feature activates, the safety belt warning light illuminates and a warning tone sounds for 6 seconds every 25 seconds, repeating for about 5 minutes or until you and the front seat passenger buckle your safety belts. |
| The safety belt for the driver or front passenger is unbuckled for about 1 minute while the vehicle is traveling at least 6 mph (9.7 km/h) and more than 1–2 minutes elapse after you switch the ignition on... | The Belt-Minder feature activates, the safety belt warning light illuminates and a warning tone sounds for 6 seconds every 25 seconds, repeating for about 5 minutes or until you and the front seat passenger buckle your safety belts. |

# Seatbelts

## Deactivating and Activating the Belt-Minder Feature

### WARNING



While the system allows you to switch this feature off, the intent of the system is to remind you to wear your safety belt to improve your chance to survive an accident. We recommend you leave the system switched on for yourself and others who may use the vehicle.

**Note:** *The driver and front passenger warnings switch on and off independently. When you perform this procedure for one seating position, do not buckle the other position as this will terminate the process.*

Read Steps 1–4 thoroughly before proceeding with the programming procedure.

Before following the procedure, make sure that:

- The parking brake is set.
  - The transmission is in park (P) or neutral (N).
  - The ignition is off.
  - The driver and front passenger safety belts are unbuckled.
1. Switch the ignition on. Do not start the vehicle.
  2. Wait until the safety belt warning light turns off (about 1 minute). After Step 2, wait an additional 5 seconds before proceeding with Step 3. Once you start Step 3, you must complete the procedure within 20 seconds.
  3. For the seating position you are switching off, buckle then unbuckle the safety belt three times at a moderate speed, ending in the unbuckled state. After Step 3, the safety belt warning light turns on.

4. While the safety belt warning light is on, buckle and then unbuckle the safety belt. After Step 4, the safety belt warning light flashes for confirmation.
  - This will switch the feature off for that seating position if it is currently on.
  - This will switch the feature on for that seating position if it is currently off.

## CHILD RESTRAINT AND SEATBELT MAINTENANCE

Inspect the vehicle safety belts and child safety seat systems periodically to make sure they work properly and are not damaged. Inspect the vehicle and child seat safety belts to make sure there are no nicks, tears or cuts. Replace if necessary. All vehicle safety belt assemblies, including retractors, buckles, front safety belt buckle assemblies, buckle support assemblies (slide bar-if equipped), shoulder belt height adjusters (if equipped), shoulder belt guide on seat back (if equipped), rear inflatable safety belts (if equipped), child safety seat LATCH and tether anchors, and attaching hardware, should be inspected after a crash. Read the child restraint manufacturer's instructions for additional inspection and maintenance information specific to the child restraint.

We recommend that all safety belt assemblies in use in vehicles involved in a crash be replaced. However, if the crash was minor and an authorized dealer finds that the belts do not show damage and continue to operate properly, they do not need to be replaced. Safety belt assemblies not in use during a crash should also be inspected and replaced if either damage or improper operation is noted.

Properly care for safety belts. See **Cleaning the Interior** (page 300).

# Personal Safety System™

---

The Personal Safety System provides an improved overall level of frontal crash protection to front seat occupants and is designed to help further reduce the risk of airbag-related injuries. The system is able to analyze different occupant conditions and crash severity before activating the appropriate safety devices to help better protect a range of occupants in a variety of frontal crash situations.

Your vehicle's Personal Safety System consists of:

- Driver and passenger dual-stage airbag supplemental restraints.
- Front seat outboard safety belts with pretensioners, energy management retractors (first row only) and safety belt usage sensors.
- Driver seat position sensor.
- Front passenger sensing system.
- Passenger airbag off and on indicator lamp.
- Front crash severity sensors.
- Restraints control module with impact and safing sensors.
- Restraint system warning light and backup tone.
- The electrical wiring for the airbags, crash sensors, safety belt pretensioners, front safety belt usage sensors, driver seat position sensor, front passenger sensing system and indicator lights.

## How Does the Personal Safety System Work?

The Personal Safety System can adapt the deployment strategy of the safety devices according to crash severity and occupant conditions. A collection of crash and occupant sensors provides information to the restraints control module. During a crash, the restraints control module may deploy the safety belt pretensioners, one or both stages of the dual-stage airbags based on crash severity and occupant conditions.

# Supplementary Restraints System

## PRINCIPLE OF OPERATION

### WARNINGS

 Airbags do not inflate slowly or gently, and the risk of injury from a deploying airbag is the greatest close to the trim covering the airbag module.

 All occupants of your vehicle, including the driver, should always properly wear their safety belts, even when an airbag supplemental restraint system is provided. Failure to properly wear your safety belt could seriously increase the risk of injury or death.

 Always transport children 12 years old and under in the back seat and always properly use appropriate child restraints. Failure to follow this could seriously increase the risk of injury or death.

 Never place your arm over the airbag module as a deploying airbag can result in serious arm fractures or other injuries.

 Airbags can kill or injure a child in a child seat. Never place a rear-facing child seat in front of an active airbag. If you must use a forward-facing child seat in the front seat, move the seat upon which the child seat is installed all the way back.

 Do not attempt to service, repair, or modify the airbag supplemental restraint systems or its fuses as you could be seriously injured or killed. Contact your authorized dealer as soon as possible.

 Several airbag system components get hot after inflation. To reduce the risk of injury, do not touch them after inflation.

 If the airbag has deployed, the airbag will not function again and must be replaced immediately. If the airbag is not replaced, the unrepaired area will increase the risk of injury in a crash.

The airbags are a supplemental restraint system and are designed to work with the safety belts to help protect the driver and right front passenger from certain upper body injuries. Airbags do not inflate slowly; there is a risk of injury from a deploying airbag.

**Note:** *You will hear a loud bang and see a cloud of harmless powdery residue if an airbag deploys. This is normal.*

The airbags inflate and deflate rapidly upon activation. After airbag deployment, it is normal to notice a smoke-like, powdery residue or smell the burnt propellant. This may consist of cornstarch, talcum powder (to lubricate the bag) or sodium compounds (for example, baking soda) that result from the combustion process that inflates the airbag. Small amounts of sodium hydroxide may be present which may irritate the skin and eyes, but none of the residue is toxic.

While the system is designed to help reduce serious injuries, contact with a deploying airbag may also cause abrasions or swelling. Temporary hearing loss is also a possibility as a result of the noise associated with a deploying airbag. Because airbags must inflate rapidly and with considerable force, there is the risk of death or serious injuries such as fractures, facial and eye injuries or internal injuries, particularly to occupants who are not properly restrained or are otherwise out of position at the time of airbag deployment. Thus, it is extremely important that occupants be properly restrained as far away from the airbag module as possible while maintaining vehicle control.

Routine maintenance of the airbags is not required.

# Supplementary Restraints System

## DRIVER AND PASSENGER AIRBAGS

### WARNINGS



Never place your arm or any objects over an airbag module. Placing your arm over a deploying airbag can result in serious arm fractures or other injuries. Objects placed on or over the airbag inflation area may cause those objects to be propelled by the airbag into your face and torso causing serious injury.



Airbags can kill or injure a child in a child seat. Never place a rear-facing child seat in front of an active airbag. If you must use a forward-facing child seat in the front seat, move the seat upon which the child seat is installed all the way back.

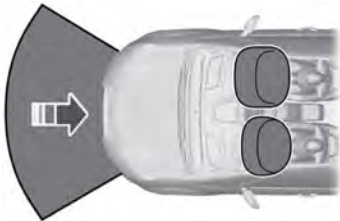

E151127

The driver and front passenger airbags will deploy during significant frontal and near frontal crashes.

The driver and passenger front airbag system consists of:

- Driver and passenger airbag modules.
- Front passenger sensing system.



• Crash sensors and monitoring system with readiness indicator. See **Crash Sensors and Airbag Indicator** (page 46).

## Proper Driver and Front Passenger Seating Adjustment

### WARNING



National Highway Traffic Safety Administration (NHTSA) recommends a minimum distance of at least 10 inches (25 centimeters) between an occupant's chest and the driver airbag module.

To properly position yourself away from the airbag:

- Move your seat to the rear as far as you can while still reaching the pedals comfortably.
- Recline the seat slightly (one or two degrees) from the upright position.

After all occupants have adjusted their seats and put on safety belts, it is very important that they continue to sit properly. A properly seated occupant sits upright, leaning against the seat back, and centered on the seat cushion, with their feet comfortably extended on the floor. Sitting improperly can increase the chance of injury in a crash event. For example, if an occupant slouches, lies down, turns sideways, sits forward, leans forward or sideways, or puts one or both feet up, the chance of injury during a crash is greatly increased.

## Children and Airbags

### WARNING



Airbags can kill or injure a child in a child seat. Never place a rear-facing child seat in front of an active airbag. If you must use a forward-facing child seat in the front seat, move the seat upon which the child seat is installed all the way back.

# Supplementary Restraints System



E142846

Children must always be properly restrained. Accident statistics suggest that children are safer when properly restrained in the rear seating positions than in the front seating position. Failure to follow these instructions may increase the risk of injury in a crash.

## FRONT PASSENGER SENSING SYSTEM

### WARNINGS



Even with Advanced Restraints Systems, children 12 and under should be properly restrained in a rear seating position. Failure to follow this could seriously increase the risk of injury or death.



Sitting improperly out of position or with the seatback reclined too far can take off weight from the seat cushion and affect the decision of the front passenger sensing system, resulting in serious injury or death in a crash. Always sit upright against your seatback, with your feet on the floor.



Any alteration or modification to the front passenger seat may affect the performance of the front passenger sensing system which could seriously increase the risk of injury or death.

This system works with sensors that are part of the front passenger seat and safety belt to detect the presence of a properly-seated occupant and determine if the front passenger frontal airbag should be enabled (may inflate) or not.



E181984

The front passenger sensing system uses a passenger airbag status indicator that will illuminate indicating that the front passenger frontal airbag is either ON (enabled) or OFF (disabled).

The indicator lamp is located in the center stack of the instrument panel.

**Note:** *The passenger airbag status indicator OFF and ON indicator lamps will illuminate for a short period of time when the ignition is first turned on to confirm it is functional.*

The front passenger sensing system is designed to disable (will not inflate) the front passenger's frontal airbag when the front passenger seat is unoccupied, or a rear facing infant seat, a forward-facing child restraint, or a booster seat is detected. Even with this technology, parents are **strongly** encouraged to always properly restrain children in the rear seat. The sensor also turns off the passenger front airbag and seat-mounted side airbag when the passenger seat is empty.



# Supplementary Restraints System

- When the front passenger sensing system disables (will not inflate) the front passenger frontal airbag, the passenger airbag status indicator will illuminate the OFF lamp and stay lit to remind you that the front passenger frontal airbag is disabled.
- If the child restraint has been installed and the passenger airbag status indicator illuminates the ON lamp, then turn the vehicle off, remove the child restraint from the vehicle and reinstall the restraint following the child restraint manufacturer's instructions.

The front passenger sensing system is designed to enable (may inflate) the front passenger's frontal airbag anytime the system senses that a person of adult size is sitting properly in the front passenger seat.

- When the front passenger sensing system enables the front passenger frontal airbag (may inflate), the passenger airbag status indicator will illuminate the ON lamp and remain illuminated.

If a person of adult size is sitting in the front passenger seat, but the airbag OFF indicator lamp is lit, it is possible that the person is not sitting properly in the seat. If this happens:

- Turn the vehicle off and ask the person to place the seatback in the full upright position.
- Have the person sit upright in the seat, centered on the seat cushion, with the person's legs comfortably extended.
- Restart the vehicle and have the person remain in this position for about two minutes. This will allow the system to detect that person and enable the passenger's frontal airbag.
- If the indicator OFF lamp remains lit even after this, the person should be advised to ride in the rear seat.

| Occupant | Passenger airbag status indicator | Passenger airbag |
|----------|-----------------------------------|------------------|
| Empty    | OFF: Lit                          | Disabled         |
|          | ON: Unlit                         |                  |
| Child    | OFF: Lit                          | Disabled         |
|          | ON: Unlit                         |                  |
| Adult    | OFF: Unlit                        | Enabled          |
|          | ON: Lit                           |                  |

**Note:** When the passenger airbag status indicator OFF light is illuminated, the passenger (seat mounted) side airbag may be disabled to avoid the risk of airbag deployment injuries.

After all occupants have adjusted their seats and put on safety belts, it is very important that they continue to sit properly. A properly seated occupant sits upright, leaning against the seatback, and centered on the seat cushion, with their

# Supplementary Restraints System

feet comfortably extended on the floor. Sitting improperly can increase the chance of injury in a crash event. For example, if an occupant slouches, lies down, turns sideways, sits forward, leans forward or sideways, or puts one or both feet up, the chance of injury during a crash is greatly increased.



Make sure the front passenger sensing system is operating properly. See **Crash Sensors and Airbag Indicator** (page 46).

Do not attempt to repair or service the system. Take your vehicle immediately to an authorized dealer.

If it is necessary to modify an advanced front airbag system to accommodate a person with disabilities, contact the Ford Customer Relationship Center. See **Getting the Services You Need** (page 256).

## SIDE AIRBAGS

### WARNINGS



Do not place objects or mount equipment on or near the airbag cover, on the side of the seatbacks (of the front seats), or in front seat areas that may come into contact with a deploying airbag. Failure to follow these instructions may increase the risk of personal injury in the event of a crash.



Do not use accessory seat covers. The use of accessory seat covers may prevent the deployment of the side airbags and increase the risk of injury in an accident.



Do not lean your head on the door. The side airbag could injure you as it deploys from the side of the seatback.

### WARNINGS



Do not attempt to service, repair, or modify the airbag, its fuses or the seat cover on a seat containing an airbag as you could be seriously injured or killed. Contact your authorized dealer as soon as possible.



If the side airbag has deployed, the airbag will not function again. The side airbag system (including the seat) must be inspected and serviced by an authorized dealer. If the airbag is not replaced, the unrepaired area will increase the risk of injury in a crash.

The side airbags are located on the outboard side of the seatbacks of the front seats. In certain sideways crashes, the airbag on the side affected by the crash will be inflated. The airbag was designed to inflate between the door panel and occupant to further enhance the protection provided occupants in side impact crashes.



E152533

The system consists of the following:

- A label or embossed side panel indicating that side airbags are fitted to your vehicle.
- Side airbags located inside the driver and front passenger seatbacks.
- Front passenger sensing system.

# Supplementary Restraints System



- Crash sensors and monitoring system with readiness indicator. See **Crash Sensors and Airbag Indicator** (page 46).

**Note:** *The passenger sensing system will deactivate the passenger seat-mounted side airbag if it detects an empty passenger seat.*

The design and development of the side airbag system included recommended testing procedures that were developed by a group of automotive safety experts known as the Side Airbag Technical Working Group. These recommended testing procedures help reduce the risk of injuries related to the deployment of side airbags.

## PASSENGER KNEE AIRBAG

The knee airbag is located under the instrument panel. During a crash, the restraints control module may activate the passenger knee airbag based on crash severity and occupant conditions. Under certain crash and occupant conditions, the passenger knee airbag may deploy but the passenger front airbag may not activate.

As with front and side airbags, it is important to be properly seated and restrained to reduce the risk of death or serious injury.

## SAFETY CANOPY™

### WARNINGS



Do not place objects or mount equipment on or near the headliner at the siderail that may come into contact with a deploying curtain airbag. Failure to follow these instructions may increase the risk of personal injury in the event of a crash.



Do not lean your head on the door. The curtain airbag could injure you as it deploys from the headliner.



Do not attempt to service, repair, or modify the curtain airbags, its fuses, the A, B, C or D pillar trim, or the headliner on a vehicle containing curtain airbags as you could be seriously injured or killed. Contact your authorized dealer as soon as possible.



All occupants of your vehicle including the driver should always wear their safety belts even when an airbag supplemental restraint system and curtain airbag is provided. Failure to properly wear your safety belt could seriously increase the risk of injury or death.



To reduce risk of injury, do not obstruct or place objects in the deployment path of the curtain airbag.



If the curtain airbags have deployed, the curtain airbags will not function again. The curtain airbags (including the A, B, C and D pillar trim and headliner) must be inspected and serviced by an authorized dealer. If the curtain airbag is not replaced, the unrepaired area will increase the risk of injury in a crash.

# Supplementary Restraints System

The Safety Canopy will deploy during significant side crashes or when a certain likelihood of a rollover event is detected by the rollover sensor. The Safety Canopy is mounted to the roof side-rail sheet metal, behind the headliner, above each row of seats. In certain sideways crashes or rollover events, the Safety Canopy will be activated, regardless of which seats are occupied. The Safety Canopy is designed to inflate between the side window area and occupants to further enhance protection provided in side impact crashes and rollover events.

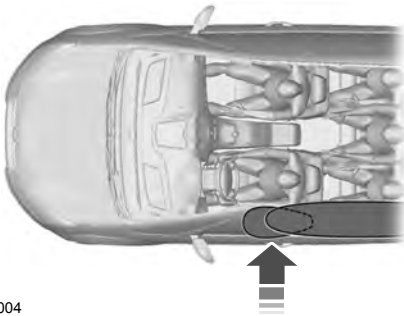

E75004

The system consists of the following:

- Safety canopy curtain airbags located above the trim panels over the front and rear side windows identified by a label or wording on the headliner or roof-pillar trim.
- A flexible headliner which opens above the side doors to allow air curtain deployment



• Crash sensors and monitoring system with readiness indicator. See **Crash Sensors and Airbag Indicator** (page 46).

Children 12 years old and under should always be properly restrained in the rear seats. The Safety Canopy will not interfere with children restrained using a properly installed child or booster seat because it is designed to inflate downward from the headliner above the doors along the side window opening.

The design and development of the Safety Canopy included recommended testing procedures that were developed by a group of automotive safety experts known as the Side Airbag Technical Working Group. These recommended testing procedures help reduce the risk of injuries related to the deployment of side airbags (including the Safety Canopy).

## CRASH SENSORS AND AIRBAG INDICATOR

### WARNING



Modifying or adding equipment to the front end of the vehicle (including frame, bumper, front end body structure and tow hooks) may affect the performance of the airbag system, increasing the risk of injury. Do not modify the front end of the vehicle.

Your vehicle has a collection of crash and occupant sensors which provide information to the restraints control module. The restraints control module deploys (activates) the front safety belt pretensioners, rear inflatable safety belts, driver airbag, passenger airbag, seat mounted side airbags, passenger knee airbag and the Safety Canopy. Based on the type of crash (frontal impact or side impact), the restraints control module will deploy the appropriate safety devices.

# Supplementary Restraints System

---

The restraints control module also monitors the readiness of the above safety devices plus the crash and occupant sensors. The readiness of the safety system is indicated by a warning indicator light in the instrument cluster or by a backup tone if the warning light is not working. Routine maintenance of the airbag is not required.

A difficulty with the system is indicated by one or more of the following:



The readiness light will not illuminate immediately after the ignition is turned on.

- The readiness light will either flash or stay lit.
- A series of five beeps will be heard. The tone pattern will repeat periodically until the problem, the light or both are repaired.

If any of these things happen, even intermittently, have the supplemental restraint system serviced at an authorized dealer immediately. Unless serviced, the system may not function properly in the event of a crash.

The safety belt pretensioners and the front airbag supplemental restraint system are designed to activate when the vehicle sustains frontal deceleration sufficient to cause the restraints control module to deploy a safety device.

The fact that the safety belt pretensioners or front airbags did not activate for both front seat occupants in a crash does not mean that something is wrong with the system. Rather, it means the restraints control module determined the accident conditions (crash severity, belt usage) were not appropriate to activate these safety devices.

- The design of the front airbags is to activate only in frontal and near-frontal crashes (not rollovers, side impacts or rear impacts) unless the crash causes sufficient frontal deceleration.
- The design of the safety belt pretensioners is to activate in frontal, near-frontal and side crashes and in rollovers.
- The design of the side airbags is to inflate in certain side impact crashes. Side airbags may activate in other types of crashes if the vehicle experiences sufficient sideways motion or deformation.
- The knee airbag(s) may deploy based on crash severity and occupant conditions.
- The design of the Safety Canopy is to inflate in certain side impact crashes or rollover events. The Safety Canopy may activate in other types of crashes if the vehicle experiences sufficient sideways motion or deformation, or a certain likelihood of rollover.

## AIRBAG DISPOSAL

Contact your authorized dealer as soon as possible. Airbags must be disposed of by qualified personnel.

# Keys and Remote Controls

---

## PRINCIPLE OF OPERATION

The remote control allows you to:

- Remotely lock or unlock the vehicle doors.
- Unlock the doors without actively using a key or remote control (intelligent access only).
- Remotely open the power liftgate (if equipped).
- Remotely start or stop the engine and user pre-set features (if equipped).
- Arm and disarm the anti-theft system.
- Activate the panic alarm.

## GENERAL INFORMATION ON RADIO FREQUENCIES

This device complies with Part 15 of the FCC Rules and with Industry Canada license-exempt RSS standard(s). Operation is subject to the following two conditions: (1) This device may not cause harmful interference, and (2) This device must accept any interference received, including interference that may cause undesired operation.

**Note:** *Changes or modifications not expressly approved by the party responsible for compliance could void the user's authority to operate the equipment. The term IC before the radio certification number only signifies that Industry Canada technical specifications were met.*

The typical operating range for your transmitter is approximately 33 ft (10 m). Vehicles with the remote start feature will have a greater range.

One of the following could cause a decrease in operating range:

- Weather conditions.
- Nearby radio towers.

- Structures around the vehicle.
- Other vehicles parked next to your vehicle.

The radio frequency used by your remote control can also be used by other radio transmitters, for example amateur radios, medical equipment, wireless headphones, wireless remote controls, cell phones, battery chargers and alarm systems. If the frequencies are jammed, you will not be able to use your remote control. You can lock and unlock the doors with the key.

**Note:** *Make sure to lock your vehicle before leaving it unattended.*

**Note:** *If you are in range, the remote control will operate if you press any button unintentionally.*

## Intelligent Access (If Equipped)

The system uses a radio frequency signal to communicate with your vehicle and authorize your vehicle to unlock when one of the following conditions are met:

- You activate the front exterior door handle switch.
- You press the luggage compartment button.
- You press a button on the transmitter.

If excessive radio frequency interference is present in the area or if the transmitter battery is low, you may need to mechanically unlock your door. You can use the mechanical key blade in your intelligent access key to open the driver door in this situation. See **Remote Control** (page 49).

# Keys and Remote Controls

## REMOTE CONTROL

### Integrated Keyhead Transmitters

(If Equipped)

Use the key blade to start your vehicle and unlock or lock the driver door from outside your vehicle. The transmitter portion functions as the remote control.



E191532

Press the button to release the key. Press and hold the button to fold the key back in when not in use.



E151795

**Note:** Your vehicle's keys came with a security tag that provides important vehicle key cut information. Keep the tag in a safe place for future reference.

## Intelligent Access Key (If Equipped)



E228148

Your intelligent access keys operate the power locks and the remote start system. The key must be in your vehicle to activate the push-button start system.

### Removable Key Blade

The intelligent access key also contains a removable mechanical key blade that you can use to unlock the driver door.

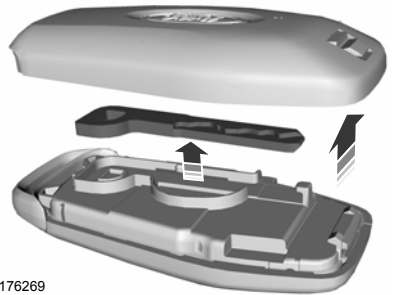

E176269

Slide the release on the back of the remote control and pivot the cover off to access the key blade.

# Keys and Remote Controls



E151795

**Note:** Your vehicle's backup keys came with a security tag that provides important vehicle key cut information. Keep the tag in a safe place for future reference.

## Replacing the Battery

**Note:** Refer to local regulations when disposing of transmitter batteries.

**Note:** Do not wipe off any grease on the battery terminals or on the back surface of the circuit board.

**Note:** Replacing the battery does not delete the transmitter from the vehicle. The transmitter should operate normally.

A message appears in the information display when the remote control battery is low. See **General Information** (page 99).

## Integrated Keyhead Transmitter

The remote control uses one coin-type three-volt lithium battery CR2032 or equivalent.

Press the button to release the key before beginning the procedure.



E191533

1. Insert a screwdriver in the position shown and gently push the clip.
2. Press the clip down to release the battery cover.

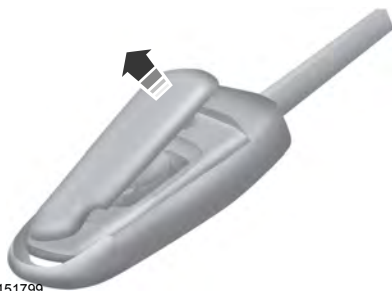

E151799

3. Carefully remove the cover.



E151800



# Keys and Remote Controls

**Note:** Do not touch the battery contacts or the printed circuit board with the screwdriver.

4. Insert a screwdriver as shown to release the battery.

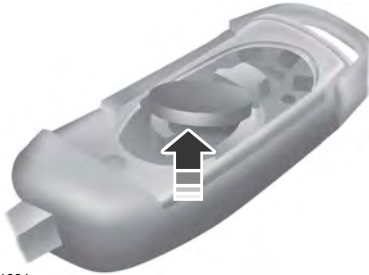

E151801

5. Remove the battery.
6. Install a new battery with the + facing up.
7. Replace the battery cover.

## Intelligent Access Transmitter

The remote control uses two coin-type three-volt lithium batteries CR2025 or equivalent.



E151796

1. Slide the release on the back of the remote control and pivot the cover off.



E153890

2. Insert a coin into the slot and twist to separate the housing.

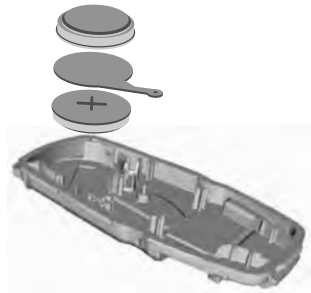

E176226

3. Remove the batteries.
4. Install new batteries with the + facing each other.

**Note:** Make sure to replace the label between the two batteries.

5. Reinstall the housing and cover.

## Memory Feature (if Equipped)

You can use the remote control to recall memory positions.

Press the unlock button on a linked remote control to recall the memory positions. If you enable the easy-entry-and-exit feature, the seat moves to the easy-entry position. The seat moves to the driver memory position when you put the key in the ignition.

# Keys and Remote Controls

## Linking a Preset Position to your Remote Control or Intelligent Access Key Fob

See **Memory Function** (page 143).

## Car Finder



Press the button twice within three seconds. The horn sounds and the direction indicators flash. We recommend you use this method to locate your vehicle, rather than using the panic alarm.

## Sounding a Panic Alarm

**Note:** *The panic alarm only operates when the ignition is off.*



Press the button to activate the alarm. Press the button again or switch the ignition on to deactivate.

## Remote Start (If Equipped)

### WARNING



To avoid exhaust fumes, do not use remote start if your vehicle is parked indoors or in areas that are not well ventilated.

**Note:** *Do not use remote start if your vehicle is low on fuel.*



The remote start button is on the transmitter.

This feature allows you to start your vehicle from outside the vehicle. The transmitter has an extended operating range.

You can configure vehicles with automatic climate control to turn on the automatic climate control when you remote start your vehicle. A manual climate control system runs at the setting you set it to when you switched off the vehicle.

Many states and provinces restrict the use of remote start. Check your local and state or provincial laws for specific requirements regarding remote start systems.

The remote start system does not work if:

- The ignition is on.
- The alarm system triggers.
- You disable the feature.
- The hood is open.
- The transmission is not in **P**.
- The vehicle battery voltage is too low.
- The service engine soon light is on.

## Remote Control Feedback

An LED on the remote control provides status feedback of remote start or stop commands.

| LED            | Status                               |
|----------------|--------------------------------------|
| Solid green    | Remote start or extension successful |
| Solid red      | Remote stop successful; vehicle off  |
| Blinking red   | Remote start or stop failed          |
| Blinking green | Waiting for status update            |

# Keys and Remote Controls

## Remote Starting the Vehicle

**Note:** You must press each button within three seconds of each other. Your vehicle remote starts only if you follow this sequence.

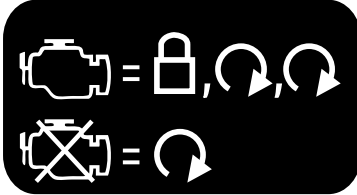

E138626

The tag with your transmitter details the starting procedure.

To remote start your vehicle:

1. Press the lock button.
2. Press the remote start button twice.  
The exterior lamps flash twice.

The horn sounds if the system fails to start, unless quiet start is on. Quiet start runs the blower fan at a slower speed to reduce noise. You can switch it on or off in the information display. See **General Information** (page 99).

**Note:** If you have remote started your vehicle with an integrated keyhead transmitter, you must switch on the ignition before driving your vehicle. With an intelligent access transmitter, you must press the brake pedal before driving your vehicle.

The power windows do not work during the remote start and the radio does not turn on automatically.

The parking lamps remain on and the vehicle runs for 5, 10 or 15 minutes depending on the setting.

## Extending the Vehicle Run Time

Repeat Steps 1 and 2 with the vehicle still running to extend the run time for another remote start period. If you programmed the periods to last 10 minutes, the second 10 minutes begins after what is left of the first activation time. For example, if the vehicle has run from the first remote start for five minutes, the vehicle continues to run now for a total of 20 minutes. You can extend the remote start up to a maximum of 35 minutes.

Wait at least five seconds before remote starting after a vehicle shutdown.

## Turning the Vehicle Off After Remote Starting



Press the button once. The parking lamps turn off.

You may have to be closer to the vehicle than when starting due to ground reflection and the added noise of the running vehicle.

You can disable or enable the remote start system through the information display. See **General Information** (page 99).

## REPLACING A LOST KEY OR REMOTE CONTROL

Replacement keys or remote controls can be purchased from an authorized dealer. Authorized dealers can program remote controls for your vehicle. See **Passive Anti-Theft System** (page 69).

## PRINCIPLE OF OPERATION

MyKey allows you to program keys with restricted driving modes to promote good driving habits. All but one of the keys programmed to the vehicle can be activated with these restricted modes.

Any keys that have not been programmed are referred to as administrator keys or admin keys. They can be used to:

- Create a MyKey.
- Program configurable MyKey settings.
- Clear all MyKey features.

When you have programmed a MyKey, you can access the following information using the information display:

- How many admin keys and MyKeys are programmed to your vehicle.
- The total distance your vehicle has traveled using a MyKey.

**Note:** All MyKeys are programmed to the same settings. You cannot program them individually.

**Note:** For vehicles equipped with a push-button start switch: When both a MyKey and an admin key are present when you start your vehicle, the system recognizes the admin key only.

## Non-configurable Settings

The following settings cannot be changed by an admin key user:

- Belt-Minder or safety belt reminder. You cannot disable this feature. The audio system will mute when the front seat occupants' safety belts are not fastened.
- Early low fuel. The low fuel warning is activated earlier, giving the MyKey user more time to refuel.

- Driver assist features, if equipped on your vehicle, are forced on: parking aid, blind spot information system (BLIS), cross traffic alert, lane departure warning and forward collision warning system.
- Satellite radio adult content restrictions (available only in some markets).

**Note:** When you switch lane departure warning off temporarily, it turns on at the next ignition cycle.

## Configurable Settings

With an admin key, you can configure certain MyKey settings when you first create a MyKey and before you recycle the key or restart the vehicle. You can also change the settings afterward with an admin key:

- A vehicle speed limit can be set. Warnings will be shown in the display, followed by an audible tone when your vehicle reaches the set speed. You cannot override the set speed by fully depressing the accelerator pedal or by setting cruise control.

### WARNING



Do not set MyKey maximum speed limit to a limit that will prevent the driver from maintaining a safe speed considering posted speed limits and prevailing road conditions. The driver is always responsible to drive in accordance with local laws and prevailing conditions. Failure to do so could result in accident or injury.

# MyKey™

- Various vehicle speed reminders so you know when your vehicle approaches the limits. Warnings appear in the information display and an audible warning sounds when you exceed the limit.
- Audio system maximum volume of 45%. A message will be shown in the display when you attempt to exceed the limited volume. Also, the speed-sensitive or compensated automatic volume control will be disabled.
- Always on setting. When this is selected, you will not be able to turn off Advance Trac or traction control, 911 Assist or Emergency Assistance, or Do Not Disturb (if your vehicle is

equipped with these features).

## CREATING A MYKEY

Use the information display to create a MyKey:

1. Insert the key you want to program into the ignition. If your vehicle is equipped with a push-button start, place the key fob into the backup slot. The location of your backup slot is in another chapter. See **Keyless Starting** (page 162).
2. Switch the ignition on.
3. Access the main menu on the information display controls. Use the arrow keys to get to the following menu selections:

| Message      | Action and Description                             |
|--------------|--|
| Settings     | Press the <b>OK</b> button or the right arrow key. |
| MyKey        | Press the <b>OK</b> button or the right arrow key. |
| Create MyKey | Press the <b>OK</b> button or the right arrow key. |

When prompted, hold the **OK** button until you see a message informing you to label this key as a MyKey. The key will be restricted at the next start.

MyKey is successfully created. Make sure you label it so you can distinguish it from the admin keys.

You can also program configurable settings for the key(s). See

### **Programming/Changing Configurable Settings.**

## **Programming/Changing Configurable Settings**

Use the information display to access your configurable MyKey settings.

1. Switch the ignition on using an admin key or fob.
2. Access the main menu on the information display controls. Use the arrow keys to get to the following menu selections:

| Message  | Action and Description                             |
|----------|--|
| Settings | Press the <b>OK</b> button or the right arrow key. |
| MyKey    | Press the <b>OK</b> button or the right arrow key. |

**Note:** You can clear or change your MyKey settings at any time during the same key cycle as you created the MyKey. Once you have switched the vehicle off, however, you will need an admin key to change or clear your MyKey settings.

## CLEARING ALL MYKEYS

You can clear or change your MyKey settings using the information display control on the steering wheel. See **Information Displays** (page 99).

Switch the ignition on using an admin key.

**To clear all MyKeys of all MyKey settings, press the left arrow button to access the main menu and scroll to:**

| Message               | Action and Description  |
|-----------------------|---|
| Settings              | Press the <b>OK</b> button.   |
| MyKey                 | Press the <b>OK</b> button.   |
| Clear MyKey           | Press and hold the <b>OK</b> button until the following message displays. |
| All MyKeys<br>Cleared |   |

**Note:** When you clear your MyKeys, you remove all restrictions and return all MyKeys to their original admin key status.

## CHECKING MYKEY SYSTEM STATUS

You can find information on programmed MyKey(s) using the information display control on the steering wheel. See **Information Displays** (page 99).

**To find information on programmed MyKey(s), press the left arrow button to access the main menu and scroll to:**

| Message                             | Description  |
|-------------------------------------|--|
| Settings                            | Press the <b>OK</b> button.  |
| MyKey                               | Press the <b>OK</b> button.  |
| <b>Select one of the following:</b> |  |
| MyKey Dist.                         | Tracks the distance when drivers use a MyKey. The only way to delete the accumulated distance is by using an admin key to clear your MyKeys. If the distance does not accumulate as expected, then the intended user is not using the MyKey, or an admin key user recently cleared and then recreated a MyKey. |
| {0} MyKeys                          | Indicates the number of MyKeys programmed to your vehicle. Use this feature to detect how many MyKeys you have for your vehicle and determine when a MyKey has been deleted.   |
| {0} Admin Keys                      | Indicates how many admin keys are programmed to your vehicle. Use this feature to determine how many unrestricted keys you have for your vehicle, and detect if an additional MyKey has been programmed.   |

## USING MYKEY WITH REMOTE START SYSTEMS

MyKey is not compatible with non

Ford-approved, aftermarket remote start systems. If you choose to install a remote start system, see an authorized dealer for a Ford-approved remote start system.

## MYKEY TROUBLESHOOTING

| Condition                                   | Potential Causes  |
|---|---|
| I cannot create a MyKey.                    | <ul style="list-style-type: none"> <li>• The key or transmitter used to start the vehicle does not have admin privileges.</li> <li>• The key or transmitter used to start the vehicle is the only admin key (there always has to be at least one admin key).</li> <li>• Vehicles with keyless start: The keyless start transmitter is not placed in the backup position. See <b>Starting a Gasoline Engine</b> (page 163).</li> <li>• SecuriLock passive anti-theft system is disabled or in unlimited mode.</li> </ul> |
| I cannot program the configurable settings. | <ul style="list-style-type: none"> <li>• The key or transmitter used to start your vehicle does not have admin privileges.</li> <li>• No MyKeys are created. See <b>Creating a MyKey</b> (page 55).</li> </ul>  |
| I cannot clear the MyKeys.                  | <ul style="list-style-type: none"> <li>• The key or transmitter used to start your vehicle does not have admin privileges.</li> <li>• No MyKeys are created. See <b>Creating a MyKey</b> (page 55).</li> </ul>  |
| I lost the only admin key.                  | Purchase a new key from an authorized dealer.   |



# MyKey™

| Condition  | Potential Causes   |
|--|--|
| I lost a key.  | Program a spare key. See <b>Passive Anti-Theft System</b> (page 69).   |
| MyKey distances do not accumulate.                     | <ul style="list-style-type: none"><li>• The MyKey user is not using the MyKey.</li><li>• An admin key holder cleared the MyKeys and created new MyKeys.</li><li>• The key system has been reset.</li></ul> |
| No MyKey functions with the keyless entry transmitter. | <ul style="list-style-type: none"><li>• An admin transmitter is present at vehicle start.</li><li>• No MyKeys are created. See <b>Creating a MyKey</b> (page 55).</li></ul>                                |

# Locks

## LOCKING AND UNLOCKING

You can use the power door lock control or the remote control to lock and unlock your vehicle.

### Power Door Locks

The power door lock control is on the driver and front passenger door panels.

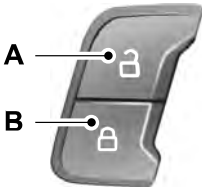

E138628

- A Unlock.
- B Lock.

### Remote Control

You can use the remote control at any time.

#### Unlocking the Doors (Two-Stage Unlock)



Press the button to unlock the driver door.

Press the button again within three seconds to unlock all doors. The direction indicators will flash.

Press and hold both the lock and unlock buttons on the remote control for three seconds to change between driver door or all doors unlock mode. The direction indicators will flash twice to indicate a change to the unlocking mode. Driver door mode only unlocks the driver door when

you press the unlock button once. All door mode unlocks all doors when you press the unlock button once. The unlocking mode applies to the remote control, keyless entry keypad and intelligent access.

### Locking the Doors



Press the button to lock all doors. The direction indicators will flash.

Press the button again within three seconds to confirm that all the doors are closed. The doors will lock again, the horn will sound and the direction indicators will flash if all the doors and the liftgate are closed.

**Note:** *If any door or the liftgate is open, or if the hood is open on vehicles with an anti-theft alarm or remote start, the horn will sound twice and the direction indicators will not flash.*

### Locking and Unlocking the Doors with the Key Blade

#### Locking with the Key

Turn the top of the key toward the front of your vehicle.

#### Unlocking with the Key

Turn the top of the key toward the rear of your vehicle.

**Note:** *If the child safety locks are on and you pull the interior handle, you will only turn off the emergency locking, not the child safety lock. You can only open the doors using the external door handle.*

#### Activating Intelligent Access (if Equipped)

The intelligent access key must be within 3 ft (1 m) of your vehicle.

# Locks

## At a Door

Pull a front exterior door handle to unlock and open the door. Do not touch the lock sensor on the front of the handle.

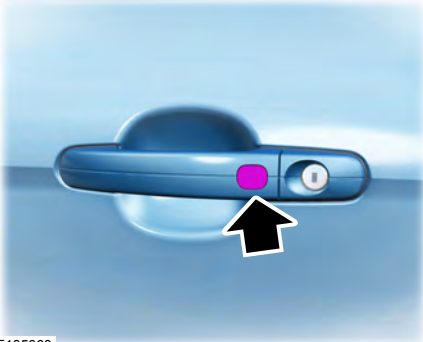

E185863

The locking sensors are on the front door handles.

Touch the locking area on the front of the door handle to lock your vehicle. There is a brief delay before you can unlock your vehicle again.

**Note:** *Keep the door handle clean to make sure the system operates correctly.*

**Note:** *Your vehicle does not automatically lock. If you do not touch a locking sensor your vehicle will remain unlocked.*

## At the Liftgate

Press the exterior liftgate release button on the top of the liftgate pull-cup handle. See **Manual Liftgate** (page 63).

## Smart Unlocks for Integrated Keyhead Transmitter (If Equipped)

This helps to prevent you from locking yourself out of your vehicle if the key is still in the ignition.

When you open one of the front doors and lock your vehicle with the power door lock control, all the doors will lock then unlock and the horn will sound twice if the key is still in the ignition.

You can still lock your vehicle with the key in the ignition by either:

- Using the keyless entry keypad with the driver door closed.
- Pressing the lock button on the remote control even if the doors are not closed.

If both front doors are closed, you can lock your vehicle by any method, regardless of whether the key is in the ignition or not.

## Smart Unlocks for Intelligent Access Keys (If Equipped)

This helps to prevent you from locking your key inside the passenger compartment or rear cargo area.

When you electronically lock your vehicle with any door open, transmission in park (P) and the ignition off, the system will search for an intelligent access key in the passenger compartment after you close the last door. If the system finds a key, all of the doors will immediately unlock and the horn sounds twice, indicating that a key is inside.

You can override the smart unlock feature and intentionally lock the intelligent access key inside your vehicle.

To override smart unlock, lock your vehicle after you have closed all doors by:

- Using the keyless entry keypad.
- Pressing the lock button on another intelligent access key.
- Touching the locking area on the front of the door handle with another intelligent access key in your hand.

# Locks

When you open one of the front doors and lock your vehicle using the power door lock control, all doors will lock then unlock if:

- The ignition is on.
- The ignition is off and the transmission is not in park (P).

## **Autolock (If Equipped)**

Autolock locks all the doors when all of the following occur:

- All doors are closed.
- The ignition is on.
- You shift into any gear putting your vehicle in motion.
- Your vehicle attains a speed greater than 4 mph (7 km/h).

## **Autounlock**

Autounlock unlocks all the doors when all of the following occur:

- The ignition is on, all the doors are closed and your vehicle has been in motion at a speed greater than 4 mph (7 km/h).
- Your vehicle comes to a stop and you switch the ignition off or to accessory.
- You open the driver door within 10 minutes of switching the ignition off or to accessory.

**Note:** *If you electronically lock your vehicle after you switch the ignition off with the driver door closed, the doors will not autounlock.*

## **Enabling or Disabling Autolock and Autounlock**

**Note:** *You can switch autounlock and autolock on or off independently of each other.*

Autolock is not configurable in all markets. If the autolock settings are not available in your information display, then the system is not configurable. See **General Information** (page 99).

## **Illuminated Entry**

The interior lamps and some exterior lamps illuminate when you unlock the doors with the remote control.

The lamps turn off if:

- The ignition is on.
- You press the remote control lock button.
- 25 seconds have elapsed.

The lamps do not turn off if:

- You switch them on with the lighting control.
- Any door is open.

## **Illuminated Exit**

The interior lamps and some exterior lamps illuminate when all doors are closed and you switch the ignition off.

The lamps will turn off if all the doors remain closed and:

- 25 seconds have elapsed.
- You lock your vehicle from the outside.

## **Battery Saver**

If you leave the courtesy lamps, interior lamps or headlamps on, the battery saver shuts them off 10 minutes after you switch the ignition off.

## **Battery Saver for Intelligent Access Keys (If Equipped)**

If you leave the ignition switched on and the engine is not running, the battery saver will turn the ignition off when it detects a certain amount of battery drain, or after 45 minutes have elapsed.

# Locks

## MANUAL LIFTGATE

### WARNINGS



It is extremely dangerous to ride in a cargo area, inside or outside of a vehicle. In a crash, people riding in these areas are more likely to be seriously injured or killed. Do not allow people to ride in any area of your vehicle that is not equipped with seats and safety belts. Be sure everyone in your vehicle is in a seat and using a safety belt properly. Failure to follow this warning could result in serious personal injury or death.



Make sure to close and latch the liftgate to prevent drawing exhaust fumes into your vehicle. This will also prevent passengers and cargo from falling out. If you must drive with the liftgate open, keep the vents or windows open so outside air comes into your vehicle. Failure to follow this warning could result in serious personal injury.

**Note:** Be careful when opening or closing the liftgate in a garage or other enclosed area to avoid damaging the liftgate.

**Note:** Do not hang anything, for example a bike rack, from the glass or liftgate. This could damage the liftgate and its components.

**Note:** Do not leave the liftgate open while driving. This could damage the liftgate and its components.

## Opening the Liftgate

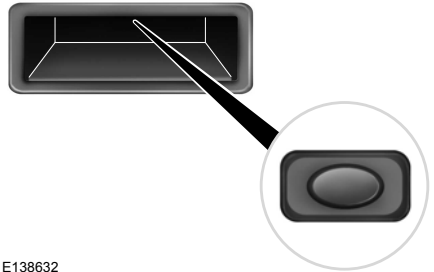

E138632

Press the button located in the top of the liftgate pull cup handle to unlatch the liftgate, and then pull on the outside handle.

## Closing the Liftgate



E155976

A handle is inside the liftgate to help with closing.

# Locks

## POWER LIFTGATE (If Equipped)

### WARNINGS



It is extremely dangerous to ride in a cargo area, inside or outside of a vehicle. In a crash, people riding in these areas are more likely to be seriously injured or killed. Do not allow people to ride in any area of your vehicle that is not equipped with seats and seatbelts. Make sure everyone in your vehicle is in a seat and properly using a seatbelt. Failure to follow this warning could result in serious personal injury or death.



Make sure to close and latch the liftgate to prevent drawing exhaust fumes into your vehicle. This will also prevent passengers and cargo from falling out. If you must drive with the liftgate open, keep the vents or windows open so outside air comes into your vehicle. Failure to follow this warning could result in serious personal injury.



Keep keys out of reach of children. Do not allow children to operate or play near an open or moving power liftgate. You should supervise the operation of the power liftgate at all times.

**Note:** Make sure that you close the liftgate before operating or moving your vehicle, especially in an enclosure, like a garage or a parking structure. This could damage the liftgate and its components.

**Note:** Do not hang anything, for example a bike rack, from the glass or liftgate. This could damage the liftgate and its components.

The liftgate only operates with the transmission in park (P).

If there is a problem with the open or close request, a tone will sound for one of the following reasons:

- The ignition is on and the transmission is not in park (P).
- The battery voltage is below the minimum operating voltage.
- The liftgate is not fully closed and your vehicle speed is at or above 3 mph (5 km/h).

If the liftgate starts to close after it has fully opened, this indicates there may be excessive weight on the liftgate or a possible strut failure. A repetitive tone sounds and the liftgate closes under control. Remove any excessive weight from the liftgate. If the liftgate continues to close after opening, have the system checked by an authorized dealer.

## Opening and Closing the Liftgate

### WARNING



Make sure all persons are clear of the power liftgate area before using the power liftgate control.

**Note:** Make sure the area behind your vehicle is free from obstruction and that there is enough room for you to operate the liftgate. Objects too close to your vehicle, for example a wall, garage door or another vehicle may come into contact with the moving liftgate. This could damage the liftgate and its components.

**Note:** Be careful when opening or closing the liftgate in a garage or other enclosed area to avoid damaging the liftgate.

**Note:** Do not leave the liftgate open while driving. This could damage the liftgate and its components.

## From the Instrument Panel



Press the button on the instrument panel.

# Locks

## With the Remote Control



Press the button twice within three seconds.

## With the Outside Control Button

### Opening the Liftgate

1. Unlock the liftgate with the remote control or power door unlock control. If an intelligent access key is within 3 ft (1 m) of the liftgate, the liftgate unlocks when you press the liftgate release button.

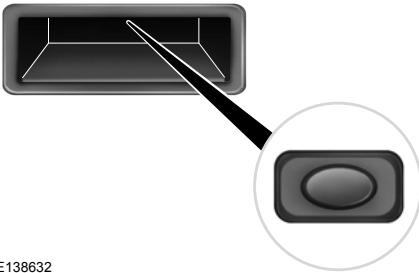

E138632

2. Press the control button located in the top of the liftgate pull-cup handle.

**Note:** Allow the power system to open the liftgate. Manually pushing or pulling the liftgate may activate the system's obstacle detection feature and stop the power operation or reverse its direction. Manually interfering with the liftgate motion may also replicate a strut failure.

### Closing the Liftgate

#### WARNING



Keep clear of the liftgate when activating the rear switch.

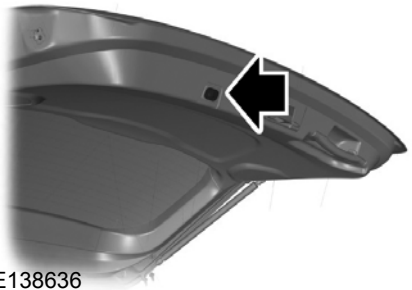

E138636

Press and release the liftgate control button.

### Stopping the Liftgate Movement

**Note:** Do not apply sudden excessive force to the liftgate while it is in motion. This could damage the power liftgate and its components.

You can stop the liftgate movement by doing any of the following:

- Pressing the liftgate control button.
- Pressing the liftgate button on the remote control twice.
- Pressing the liftgate button on the instrument panel.
- Moving your foot under and away from the center rear bumper in a single-kick motion.\*

\*This method only works for vehicles with the hands-free liftgate feature.

### Setting the Liftgate Open Height

1. Open the liftgate.
2. Stop the liftgate movement by pressing the control button on the liftgate when it reaches the desired height.

**Note:** Once the liftgate has stopped moving, you can also manually move it to the desired height.

# Locks

3. Press and hold the liftgate control button on the liftgate until you hear a tone, indicating programming is complete.

**Note:** You can only use the liftgate control button to program the height.

**Note:** You cannot program the height if the liftgate position is too low.

The new open liftgate height is recalled when the power liftgate is opened. To change the programmed height, repeat the above procedure. Once you open the power liftgate, you can manually move it to a different height.

**Note:** The system recalls the new programmed height until you reprogram it, even if you disconnect the battery.

When operating the power liftgate after you have programmed a lower height than fully open, you can fully open the liftgate by manually pushing it upward to the maximum open position.

## Obstacle Detection

### When Closing

The system stops when it detects an obstacle. A tone sounds and the system reverses to open. Once you remove the obstacle, you can power close the liftgate.

**Note:** Entering your vehicle while the liftgate is closing can cause your vehicle to bounce and activate obstacle detection. To prevent this, let the power liftgate close completely before you enter your vehicle. Before driving off, check the instrument cluster for a liftgate or door ajar message or warning indicator. Failure to do this could result in unintentionally leaving the liftgate open while driving.

### When Opening

The system stops when it detects an obstacle and a tone sounds. Once you remove the obstacle, you can continue to operate the liftgate.

### Hands-Free Feature (If Equipped)

Make sure you have an intelligent access transmitter within 3 ft (1 m) of the liftgate.

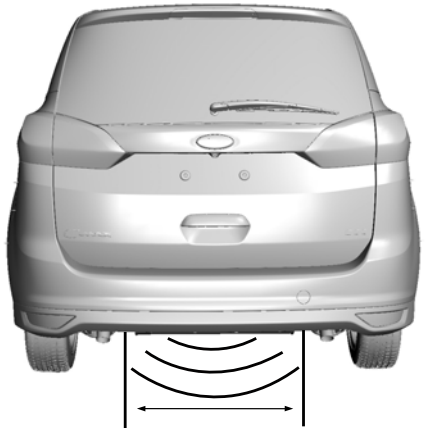

E174120

1. Move your foot under and away from the rear bumper detection area in a single-kick motion. Do not move your foot sideways or the sensors may not detect the motion.
2. The liftgate will power open or close.



# Locks

**Note:** Allow the power system to open the liftgate. Manually pushing or pulling the liftgate may activate the system's obstacle detection feature and stop the power operation or reverse its direction. Manually interfering with the liftgate motion may also replicate a strut failure.

**Note:** Splashing water may cause the hands-free liftgate to open. Keep the intelligent access key away from the rear bumper detection area when washing your vehicle.

## KEYLESS ENTRY

### SECURICODE™ Keyless Entry Keypad

The keypad is near the driver window. It illuminates when touched.

**Note:** If you enter your entry code too fast on the keypad, the unlock function may not work. Enter your entry code again more slowly.

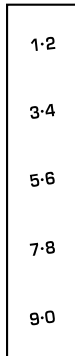

E138637

You can use the keypad to do the following:

- Lock or unlock the doors.
- Program and erase user codes.
- Arm and disarm the anti-theft alarm.
- Recall memory seat and mirror positions.

You can operate the keypad with the factory-set five-digit entry code. The code is on the owner's wallet card in the glove box and is available from an authorized dealer. You can also program up to five of your own five-digit personal entry codes.

### Programming a Personal Entry Code

1. Enter the factory-set five-digit code.
2. Press **1-2** on the keypad within five seconds.
3. Enter your personal five-digit code. You must enter each number within five seconds of each other.
4. Press **1-2** on the keypad to save personal code 1.

The doors lock then unlock to confirm that programming was successful.

To program additional personal entry codes, repeat steps 1 through 3, then for step 4:

- Press **3-4** to save personal code 2.
- Press **5-6** to save personal code 3.
- Press **7-8** to save personal code 4.
- Press **9-0** to save personal code 5.

### Hints:

- Do not set a code that uses five of the same number.
- Do not use five numbers in sequential order.
- The factory-set code works even if you have set your own personal code.

# Locks

---

## **Recalling Memory Positions (If Equipped)**

The programmed entry codes recall driver memory positions as follows:

- Entry code 1 recalls driver 1 memory positions.
- Entry code 2 recalls driver 2 memory positions.
- Entry code 3 recalls driver 3 memory positions.

**Note:** *Personal entry codes 4 and 5 will not recall memory positions.*

## **Erasing a Personal Code**

1. Enter the factory-set five-digit code.
2. Press and release **1-2** on the keypad within five seconds.
3. Press and hold **1-2** for two seconds. You must do this within five seconds of completing step 2.

All personal codes erase and only the factory-set five-digit code works.

## **Anti-Scan Feature**

The keypad goes into an anti-scan mode if you enter the wrong code seven times. This mode turns off the keypad for one minute and the keypad lamp flashes.

The anti-scan feature turns off after any of the following occur:

- One minute of keypad inactivity.
- You press the unlock button on the remote control.
- You switch your vehicle on.
- You unlock the vehicle using intelligent access.

## **Locking and Unlocking the Doors**

### **Locking All Doors**

Press and hold **7-8** and **9-0** on the keypad simultaneously with the driver door closed. You do not need to enter a code first.

### **Unlocking All Doors**

Enter the factory-set code or your personal code, then press **3-4** on the keypad within five seconds.

### **Unlocking Only the Driver Door**

Enter the factory-set or your personal five-digit code. You must press each number within five seconds of each other. The interior lamps illuminate.

**Note:** *All doors unlock if the two-stage unlocking feature is turned off. See **Locking and Unlocking** (page 60).*

# Security

## PASSIVE ANTI-THEFT SYSTEM

**Note:** The system is not compatible with non-Ford aftermarket remote start systems. Use of these systems may result in vehicle starting problems and a loss of security protection.

**Note:** Metallic objects, electronic devices or a second coded key on the same key chain may cause vehicle starting problems if they are too close to the key when starting the engine. Prevent these objects from touching the coded key while starting the engine. Switch the ignition off, move all objects on the key chain away from the coded key and restart the engine if a problem occurs.

**Note:** Do not leave a duplicate coded key in the vehicle. Always take your keys and lock all doors when leaving the vehicle.

### SecuriLock®

The system is an engine immobilization system. It is designed to help prevent the engine from being started unless a coded key programmed to your vehicle is used. Using the wrong key may prevent the engine from starting. A message may appear in the information display.

If you are unable to start the engine with a correctly coded key, a malfunction has happened and a message may appear in the information display.

### Automatic Arming

The vehicle arms immediately after you switch the ignition off.

### Automatic Disarming

Switching the ignition on with a coded key disarms the vehicle.

## Replacement Keys

**Note:** Your vehicle comes equipped with two integrated keyhead transmitters or two intelligent access keys.

The integrated keyhead transmitter functions as a programmed ignition key that operates all the locks and starts the vehicle, as well as a remote control.

The intelligent access key functions as a programmed key that operates the driver door lock and activates the intelligent access with push button start system, as well as a remote control.

If your programmed transmitters or standard SecuriLock coded keys (integrated keyhead transmitters only) are lost or stolen and you do not have an extra coded key, you will need to have your vehicle towed to an authorized dealer. You need to erase the key codes from your vehicle and program new coded keys.

Store an extra programmed key away from the vehicle in a safe place to help prevent any inconveniences. See your authorized dealer to purchase additional spare or replacement keys.

### Programming a Spare Integrated Keyhead Transmitter

**Note:** You can program a maximum of eight coded keys to your vehicle. All eight can be integrated keyhead transmitters.

You can program your own integrated keyhead transmitter or standard SecuriLock coded keys to your vehicle. This procedure will program both the engine immobilizer keycode and the remote entry portion of the remote control to your vehicle

Only use integrated keyhead transmitters or standard SecuriLock keys.

# Security

---

You must have two previously programmed coded keys and the new unprogrammed key readily accessible. See your authorized dealer to have the spare key programmed if two previously programmed coded keys are not available.

Read and understand the entire procedure before you begin.

1. Insert the first previously programmed coded key into the ignition.
2. Switch the ignition from off to on. Keep the ignition on for at least three seconds, but no more than 10 seconds.
3. Switch the ignition off and remove the first coded key from the ignition.
4. After three seconds but within 10 seconds of switching the ignition off, insert the second previously coded key into the ignition.
5. Switch the ignition from off to on. Keep the ignition on for at least three seconds, but no more than 10 seconds.
6. Switch the ignition off and remove the second previously programmed coded key from the ignition.
7. After three seconds but within 10 seconds of switching the ignition off and removing the previously programmed coded key, insert the new unprogrammed key into the ignition.
8. Switch the ignition from off to on. Keep the ignition on for at least six seconds.
9. Remove the newly programmed coded key from the ignition.

If the key has been successfully programmed it will start the engine and operate the remote entry system (if the new key is an integrated keyhead transmitter).

If programming was not successful, wait 10 seconds and repeat Steps 1 through 8. If you are still unsuccessful, take your vehicle to your authorized dealer.

## Programming a Spare Intelligent Access Key

See your authorized dealer to have additional keys programmed to your vehicle.

## ANTI-THEFT ALARM

The system will warn you of an unauthorized entry to your vehicle. It will be triggered if any door, the luggage compartment or the hood is opened without using the key, remote control or keyless entry keypad.

The direction indicators will flash and the horn will sound if unauthorized entry is attempted while the alarm is armed.

Take all remote controls to an authorized dealer if there is any potential alarm problem with your vehicle.

### Arming the Alarm

The alarm is ready to arm when there is not a key in your vehicle. Electronically lock your vehicle to arm the alarm.

### Disarming the Alarm

Disarm the alarm by any of the following actions:

- Unlock the doors or luggage compartment with the remote control or keyless entry keypad.
- Switch your vehicle on or start your vehicle.
- Use a key in the driver door to unlock your vehicle, then switch your vehicle on within 12 seconds.

**Note:** *Pressing the panic button on the remote control will stop the horn and signal indicators, but will not disarm the system.*

# Steering Wheel

## ADJUSTING THE STEERING WHEEL - VEHICLES WITH: MANUAL ADJUSTABLE STEERING COLUMN

### WARNING



Do not adjust the steering wheel when your vehicle is moving.

**Note:** Make sure that you are sitting in the correct position. See **Sitting in the Correct Position** (page 137).



E191039

1. Unlock the steering column.
2. Adjust the steering wheel to the desired position.



E191047

3. Lock the steering column.

## ADJUSTING THE STEERING WHEEL - VEHICLES WITH: POWER ADJUSTABLE STEERING COLUMN

**Note:** Make sure that you are sitting in the correct position. See **Sitting in the Correct Position** (page 137).

### WARNING



Do not adjust the steering wheel when your vehicle is moving.



E161834

Use the control on the side of the steering column to adjust the position.

To adjust:

- Tilt: Press the top or bottom of the control.
- Telescope: Press the front or rear of the control.

# Steering Wheel

## End of Travel Position

The steering column sets a stopping position just short of the end of the column position to prevent damage to the steering column. A new stopping position sets if the steering column encounters an object when tilting or telescoping.

To reset the steering column to its normal stopping position:

1. Confirm there is nothing obstructing the motion of the steering column.
2. Press and hold the steering column control until the steering column stops moving.
3. Press the steering column control again. The steering column may begin to move again.
4. When the steering column stops, continue holding the control for an additional few seconds.
5. Repeat for each direction as necessary.

A new stopping position is set. The next time you tilt or telescope the steering column, it will stop just short of the end of the column position.

## Memory Feature

You can save and recall the steering column position with the memory function. See **Memory Function** (page 143).

**Note:** *Pressing the adjustment control during memory recall cancels the operation.*

## Easy Entry and Exit Feature

When you switch the ignition off, the steering column will move to allow extra room to exit your vehicle. The column will return to the previous setting when you switch the ignition on. You can enable or disable this feature in the information display. See **Information Displays** (page 99).

## AUDIO CONTROL

You can operate the following functions with the control:

### Type 1

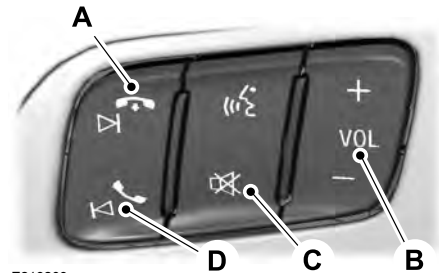

E213209

- A Seek up or next and end call.
- B Volume up or down.
- C Mute.
- D Seek down or previous and answer call.

### Type 2

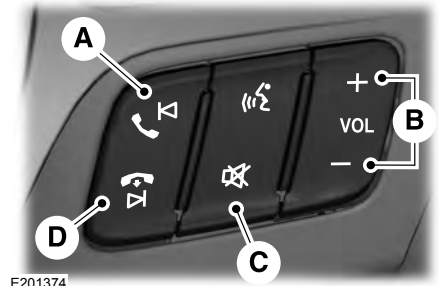

E201374

- A Seek down or previous and answer call.
- B Volume up or down.

# Steering Wheel

- C Mute.
- D Seek up or next and end call.

## Type 3

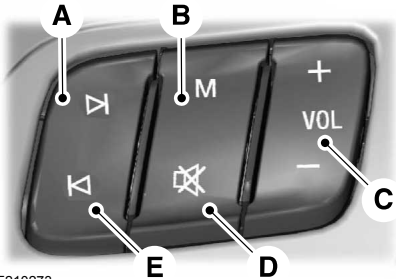

E210273

- A Seek up or next.
- B Media.
- C Volume up or down.
- D Mute.
- E Seek down or previous.

## Seek and Media

Press the seek button to:

- Tune the radio to the next or previous stored preset.
- Play the next or the previous track.

Press and hold the seek button to:

- Tune the radio to the next station up or down the frequency band.
- Seek through a track.

Press the media button repeatedly to:

- Scroll through available audio modes.

## VOICE CONTROL (If Equipped)

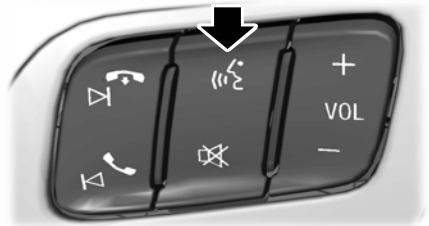

E201375

Press to select or deselect voice control. See your SYNC information.

## CRUISE CONTROL

### Type 1



E200995

# Steering Wheel

---

## Type 2



E200996

See **Cruise Control** (page 208).

## INFORMATION DISPLAY CONTROL



E201376

See **Information Displays** (page 99).

## HEATED STEERING WHEEL (if Equipped)

See **MyFord Touch™** (page 404).



# Pedals

## ADJUSTING THE PEDALS (If

Equipped)

### WARNING



Never use the controls while your feet are on the accelerator and brake pedals and the vehicle is moving.

You can find the control on the left side of the steering column. Press and hold the appropriate side of the control to move the pedals.

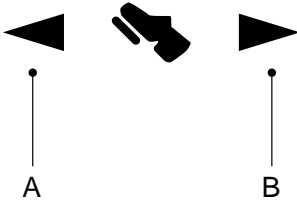

E162916

A. Farther

B. Closer

You can save and recall the pedal positions with the memory feature. See **Memory Function** (page 143).

**Note:** *Adjust the pedals only when your vehicle is in **P** (Park).*

# Wipers and Washers

## WINDSHIELD WIPERS

**Note:** Fully defrost the windshield before you switch the windshield wipers on.

**Note:** Make sure you switch the windshield wipers off before entering a car wash.

**Note:** Clean the windshield and wiper blades if they begin to leave streaks or smears. If that does not resolve the issue, install new wiper blades. See **Changing the Wiper Blades** (page 288).

**Note:** Do not operate the wipers on a dry windshield. This may scratch the glass, damage the wiper blades or cause the wiper motor to burn out. Always use the windshield washers before wiping a dry windshield.



E208209

Rotate the end of the control:

- Away from you to increase the wiper speed.
- Toward you to decrease the wiper speed.

## Speed Dependent Wipers

When your vehicle speed increases, the interval between wipes decreases.

## AUTOWIPERS (If Equipped)

**Note:** Fully defrost the windshield before switching on the windshield wipers.

**Note:** Make sure you switch off the windshield wipers before entering a car wash.

**Note:** Clean the windshield and wiper blades if they begin to leave streaks or smears. If that does not resolve the issue, install new wiper blades. See **Changing the Wiper Blades** (page 288).

Wet or winter driving conditions with ice, snow or salty road mist can cause inconsistent and unexpected wiping or smearing. In these conditions, you can do the following to help keep your windshield clear:

- Lower the sensitivity of the autowipers to reduce the amount of smearing.
- Switch to normal or high-speed wipe.
- Switch the autowipers off.

The autowipers feature uses a rain sensor, located in the area around the interior mirror. The rain sensor monitors the amount of moisture on the windshield and automatically turns on the wipers. It adjusts the wiper speed by the amount of moisture that the sensor detects on the windshield.

**Note:** This autowiper feature is automatically set to on and remains on until you switch it off in the information display. You can also switch the feature back on at any time. See **General Information** (page 99).



E208222

# Wipers and Washers

Use the rotary control to adjust the sensitivity of the rain sensor. Set the control to low sensitivity, and the wipers will turn on when the rain sensor detects a large amount of moisture on the windshield. Set the control to high sensitivity, and the wipers will turn on when the rain sensor detects a small amount of moisture on the windshield.

**Note:** When you set the wiper system to intermittent wipe and the autowiper system is on, the autowiper sensitivity setting adjusts the wiper speed according to the moisture on the windshield only. Use the wiper lever to wipe the windshield on-demand.

Keep the outside of the windshield clean. The rain sensor is very sensitive. If the area around the mirror is dirty, then the wipers may operate if dirt, mist or insects hit the windshield.

## WINDSHIELD WASHERS

**Note:** Do not operate the wipers on a dry windshield. This may scratch the glass, damage the wiper blades or cause the wiper motor to burn out. Always use the windshield washers before wiping a dry windshield.

**Note:** Do not operate the washers when the washer reservoir is empty. This may cause the washer pump to overheat.



E208224

Press the end of the wiper lever to activate the washer:

- A brief press causes a single wipe without washer fluid.
- A quick press and hold causes the wipers to swipe the windshield three times with washer fluid.
- A long press and hold activates the wipers and washer fluid for up to 10 seconds.

A wipe occurs a few seconds after washing to clear any remaining washer fluid. You can switch this feature on and off through the information display. See **General Information** (page 99).

## Front Camera Washer (If Equipped)

Operating the windshield washer also operates the front camera washer.

## REAR WINDOW WIPER AND WASHERS

### Rear Window Wiper

**Note:** Make sure you switch off the wiper system before using an automatic car wash.



E208225

# Wipers and Washers

---

Rotate the control to select:

|   |  |
|---|--|
| 2 | Intermittent operation - the shortest pause between wipes. |
| 1 | Intermittent operation - the longest pause between wipes.  |
| 0 | Off.   |

## Rear Window Washer



E208225

Rotate and hold the control to the top or bottom position to activate the rear washer. The control returns to the **2** or **0** position when you release it.

## Rear Camera Washer

Operating the rear washer also operates the rear camera washer.

# Lighting

## GENERAL INFORMATION

### Condensation in Lamp Assemblies

Exterior lamps have vents to accommodate normal changes in air pressure.

Condensation can be a natural by-product of this design. When moist air enters the lamp assembly through the vents, there is a possibility that condensation can occur when the temperature is cold. When normal condensation occurs, a fine mist can form on the interior of the lens. The fine mist eventually clears and exits through the vents during normal operation.

Clearing time may take as long as 48 hours under dry weather conditions.

Examples of acceptable condensation are:

- The presence of a fine mist (no streaks, drip marks or large droplets).
- A fine mist covers less than 50% of the lens.

Examples of unacceptable condensation are:

- A water puddle inside the lamp.
- Streaks, drip marks or large droplets present on the interior of the lens.

If you see any unacceptable condensation, have your vehicle checked by an authorized dealer.

## LIGHTING CONTROL



E142449

- A Off.
- B Position lamps, instrument panel lamps, license plate lamps and rear lamps.
- C Headlamps.

### High Beam

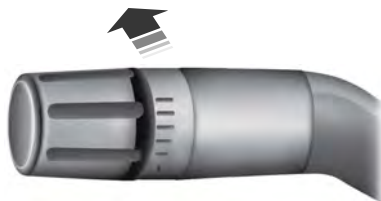

E167827

Push the lever away from you to switch the high beam on.

Push the lever forward again or pull the lever toward you to switch the high beams off.

# Lighting

## Headlamp Flasher

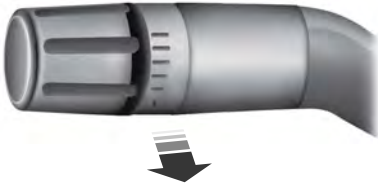

E163268

Slightly pull the lever toward you and release it to flash the headlamps.

## AUTOLAMPS (If Equipped)

### WARNING



The autolamps switch position may not activate the headlamps in all low visibility conditions, such as daytime fog. Always ensure that your headlamps are switched to auto or on, as appropriate, during all low visibility conditions. Failure to do so may result in a collision.

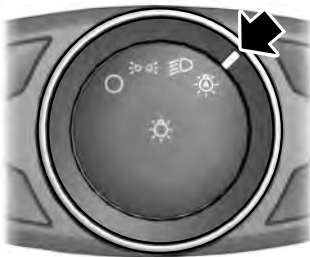

E142451

When the lighting control is in the autolamps position, the headlamps automatically turn on in low light situations or when the wipers activate.

If equipped, the following also activate when the lighting control is in the autolamps position and you switch them on in the information display:

- Configurable daytime running lamps.
- Automatic high beam control.
- Adaptive headlamp control.

The headlamps remain on for a period of time after you switch the ignition off. Use the information display controls to adjust the period of time that the headlamps remain on. See **Information Displays** (page 99).

**Note:** *With the headlamps in the autolamps position, you cannot switch the high beam headlamps on until the autolamps system turns the low beam headlamps on.*

## Windshield Wiper Activated Headlamps

The windshield wiper activated headlamps turn on within 10 seconds when you switch the windshield wipers on and the lighting control is in the autolamps position. They turn off approximately 60 seconds after you switch the windshield wipers off.

The headlamps will not turn on by wiper activation:

- During a mist wipe.
- When the wipers are on to clear washer fluid during a wash condition.
- If the wipers are in intermittent mode.

**Note:** *If you switch autolamps and autowipers on, the headlamps will automatically turn on when the windshield wipers continuously operate.*

# Lighting

## INSTRUMENT LIGHTING DIMMER

**Note:** You disable the manual dimmer when you adjust the setting to Auto Dimming in the information display. See **Information Displays** (page 99).

**Note:** If you disconnect the battery or it becomes discharged, the illuminated components will switch to the maximum setting.

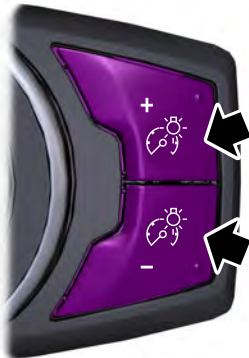

E161902

Press repeatedly or press and hold until you reach the desired level.

## HEADLAMP EXIT DELAY

You can set the delay time to keep the headlamps on for up to three minutes after you switch off the ignition.

Follow the steps below to change the delay time (Steps 1 to 6 must be completed within 10 seconds):

1. Switch the ignition off.
2. Select the autolamp position on the lighting control.
3. Turn the lighting control to the off position.

4. Switch the ignition on.
5. Switch the ignition off.
6. Select the autolamp position on the lighting control. The headlamps and parking lamps will turn on.
7. Turn the lighting control to the off position when the required delay time has been reached. The headlamps and parking lamps will turn off.

You can set the headlamp exit delay to one of the following settings:

- Off
- 10 seconds
- 20 seconds
- 120 seconds

**Note:** You can adjust the time delay using the display controls in the instrument cluster. See **Information Displays** (page 99).

## DAYTIME RUNNING LAMPS (if Equipped)

### WARNING



The daytime running lamps system does not activate the rear lamps and may not provide adequate lighting during low visibility driving conditions. Also, the autolamps switch position may not activate the headlamps in all low visibility conditions, such as daytime fog. Make sure the headlamps are switched to auto or on, as appropriate, during all low visibility conditions. Failure to do so may result in a crash.

# Lighting

## Type 1 - Conventional (Non-Configurable)

The daytime running lamps turn on when:

1. The ignition is switched to the on position.
2. The transmission is not in park (P) for vehicles with automatic transmissions or the parking brake is released for vehicles with manual transmissions.
3. The lighting control is in the off, parking lamp or autolamps positions.

## Type 2 - Configurable

Switch the daytime running lamps on or off using the information display controls. See **Information Displays** (page 99).

The daytime running lamps turn on when:

1. They are switched on in the information display. See **Information Displays** (page 99).
2. The ignition is switched to the on position.
3. The transmission is not in park (P) for vehicles with automatic transmissions or the parking brake is released for vehicles with manual transmissions.
4. The lighting control is in the autolamps position.
5. The lighting control sensor detects daylight, and the headlamps or parking lamps are off.

The other lighting control switch positions do not activate the daytime running lamps, and you can use them to temporarily override autolamp control.

When switched off in the information display, the daytime running lamps are off in all lighting control switch positions.

## AUTOMATIC HIGH BEAM CONTROL (If Equipped)

The system automatically turns on the high beams if it is dark enough and no other traffic is present. When it detects the headlights of an approaching vehicle, the tail lamps of the preceding vehicle or street lighting, the system turns off the high beams before they distract other drivers. The low beams remain on.

**Note:** *If it appears that automatic high beam is not functioning properly, check the windshield in front of the camera for a blockage. A clear view of the road is required for proper system operation. Make sure that authorized personnel repair any windshield damage in the area of the camera's field of view.*

**Note:** *If the system detects a blockage such as bird droppings, bug splatter, snow or ice, and you do not observe changes, the system may go into low beam mode until you clear the blockage. A message may also appear in the information display noting the front camera is blocked.*

**Note:** *Typical road dust, dirt and water spots do not affect the performance of the automatic high beam control. However, in cold or inclement weather conditions, you may notice a decrease in the availability of the automatic high beam control, especially at start up. If you want to change the beam state independently of the system, you may switch the high beams on or off using the high beam lever. Automatic high beam control resumes when conditions are correct.*

**Note:** *Using much larger tires or equipping vehicle accessories such as snowplows can modify your vehicle's ride height and degrade automatic high beam control performance.*



# Lighting

A camera sensor, centrally mounted behind the windshield of your vehicle, continuously monitors conditions to decide when to switch the high beams off and on.

Once the system is active, the high beams switch on if:

- The outside light level is low enough.
- There is no traffic in front of your vehicle.
- The vehicle speed is greater than 32 mph (52 km/h).

The high beams switch off if:

- The system detects the headlamps of an approaching vehicle or the rear lamps of a vehicle in front of you.
- Vehicle speed falls below 16 mph (26 km/h).
- The outside light level is high enough that high beams are not required.
- The system detects severe rain, snow or fog.
- The camera is blocked.

## Activating the System

Switch on automatic high beam control using the information display and autolamps. See **Information Displays** (page 99).

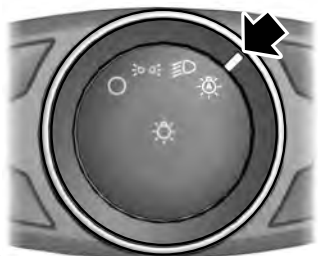

E142451

Switch the lighting control to the autolamps position.

## Manually Overriding the System

When automatic high beam control has activated the high beams, pushing or pulling the stalk provides a temporary override to low beam.

Use the information display menu to permanently deactivate the system, or switch the lighting control from autolamps to headlamps.

## FRONT FOG LAMPS



E202426

Press the button to switch the fog lamps on or off.

You can switch the fog lamps on when the lighting control is in any position except off and the high beams are not on.

# Lighting

## DIRECTION INDICATORS



E163272

- To operate the left direction indicator, push the lever down until it stops.
- To operate the right direction indicator, push the lever up until it stops.

**Note:** Tap the lever up or down to make the direction indicators flash three times.

## INTERIOR LAMPS

### Dome Lamp

#### Without Fog Lamps



E208462

### With Fog Lamps



E208463

Use to manually switch the dome lamps on.

Press the button to switch on the interior lamps. Press the button again to switch them off.

### Front Row Map Lamps (If Equipped)



E163273

To switch on the map lamps, press the outer edge of the clear lens. The lamps illuminate when:

- Any door is opened.
- The dome lamp button on the instrument panel is switched on.
- You press a remote control button and the ignition is off.

# Lighting

## Second Row Dome and Map Lamps

(If Equipped)

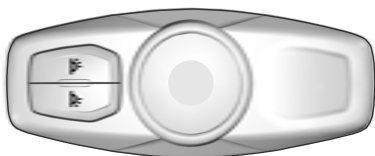

E199026

The lamps illuminate when:

- Any door is opened.
- The instrument panel dimmer is adjusted until the courtesy lamps switch on.
- You press a remote control button and the ignition is off.

## Second Row Dome and Courtesy Lamps

(If Equipped)



E208464

The lamps illuminate when:

- Any door is opened.
- The instrument panel dimmer is adjusted until the courtesy lamps switch on.
- You press a remote control button and the ignition is off.

The lamp can also be switched on and off by pressing the lens depression.

## Third Row Cargo Lamp

(If Equipped)



E169470

The lamps illuminate when:

- Any door is opened.
- The instrument panel dimmer is adjusted until the courtesy lamps switch on.
- You press a remote control button and the ignition is off.

The lamp can also be switched on and off by pressing the control switch.

## Battery Saver

If you leave the courtesy lamps, interior lamps or headlamps on, the battery saver shuts them off 10 minutes after you switch the ignition off.

The parking lamps do not turn off if they have been switched on.

# Windows and Mirrors

## POWER WINDOWS

### WARNINGS



Do not leave children unattended in your vehicle and do not let them play with the power windows. They may seriously injure themselves.



When closing the power windows, you should verify they are free of obstructions and make sure that children and pets are not in the proximity of the window openings.

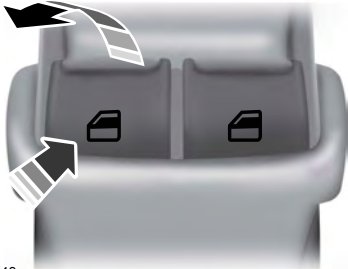

E146043

**Note:** You may hear a pulsing noise when just one of the windows is open. Lower the opposite window slightly to reduce this noise.

Press the switch to open the window.

Lift the switch to close the window.

### One-Touch Down

Press the switch fully and release it. Press again or lift it to stop the window.

### One-Touch Up

Lift the switch fully and release it. Press or lift it again to stop the window.

## Bounce-Back

The window will stop automatically while closing. It reverses some distance if there is an obstacle in the way.

## Overriding the Bounce-Back Feature

### WARNING



When you override the bounce-back feature the window will not reverse if it detects an obstacle. Take care when closing the windows to avoid personal injury or damage to your vehicle.

Pull up the window switch and hold within a few seconds of the window reaching the bounce-back position. The window travels up with no bounce-back protection. The window stops if you release the switch before the window closes fully.

## Window Lock



E144072

Press the control to lock or unlock the rear window controls. It will illuminate when you lock the rear window controls.

## Accessory Delay

You can use the window switches for several minutes after you switch the ignition off or until you open either front door.

# Windows and Mirrors

## EXTERIOR MIRRORS

### Power Exterior Mirrors

#### WARNING



Do not adjust the mirrors when your vehicle is moving.



E144073

- A Left-hand mirror.
- B Adjustment control.
- C Right-hand mirror.

To adjust your mirrors, switch your vehicle on (with the ignition in accessory mode or the engine running) and then:

1. Select the mirror you want to adjust. The control lights.
2. Use the adjustment control to adjust the position of the mirror.
3. Press the mirror control again. The control light turns off.

### Fold-Away Exterior Mirrors

Push the mirror toward the door window glass. Make sure that you fully engage the mirror in its support when returning it to its original position.

### Auto-Folding Mirrors (If Equipped)

The exterior mirrors automatically fold in toward the glass after you place the transmission into park (P), turn off the vehicle, open and close the driver's side door and lock the vehicle. The exterior mirrors automatically unfold and return to their driving position after you unlock the vehicle and open and close the driver's side door.

You can switch this feature on and off through the information display. See **General Information** (page 99).

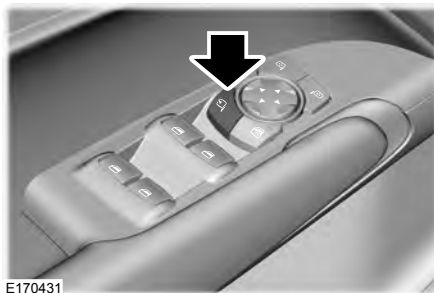

E170431

You can fold the mirrors on demand by pressing the power-folding mirror control located on the door. The control lights and the mirrors fold in toward the glass. Press the control again to unfold the mirrors. The control light turns off.

**Note:** If you use the power-folding control to fold the mirrors on demand and the auto fold feature is switched on, you must use the control again to unfold them.

### Loose Mirror

If your power-folding mirrors are manually folded, they may not work properly even after you re-position them. You need to reset them if:

- The mirrors vibrate when you drive.
- The mirrors feel loose.

# Windows and Mirrors

- The mirrors do not stay in the folded or unfolded position.
- One of the mirrors is not in its normal driving position.

To reset the power-fold feature, use the power-folding mirror control to fold and unfold the mirrors. You may hear a loud noise as you reset the power-folding mirrors. This sound is normal. Repeat this process as needed each time the mirrors are manually folded.

## Heated Exterior Mirrors (If Equipped)

See **Heated Windows and Mirrors** (page 135).

## Memory Mirrors (If Equipped)

You can save and recall the mirror positions through the memory function. See **Memory Function** (page 143).

## Auto-dimming Feature (If Equipped)

The driver exterior mirror automatically dims when the interior auto-dimming mirror turns on.

## Direction Indicator Mirrors (If Equipped)

While the vehicle is running, the forward-facing portion of the appropriate mirror housing blinks when you switch on the direction indicator.

## Integrated Blind Spot Mirror (If Equipped)

Blind spot mirrors have an integrated convex mirror built into the upper outboard corner of the exterior mirrors. They can assist you by increasing visibility along the side of your vehicle.

Check the main mirror first before a lane change, then check the blind spot mirror. If no vehicles are present in the blind spot mirror and the traffic in the adjacent lane is at a safe distance, signal that you are going to change lanes. Glance over your shoulder to verify traffic is clear, and carefully change lanes.

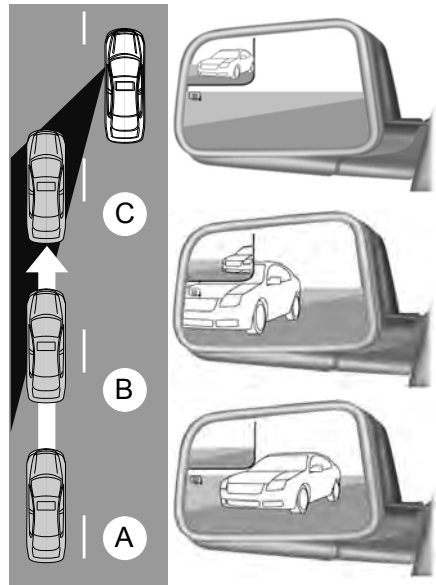

E138665

### WARNING



Objects in the blind spot mirror are closer than they appear.

# Windows and Mirrors

The image of the approaching vehicle is small and near the inboard edge of the main mirror when it is at a distance. The image becomes larger and begins to move outboard across the main mirror as the vehicle approaches (A). The image transitions from the main mirror and begins to appear in the blind spot mirror as the vehicle approaches (B). The vehicle transitions to your peripheral field of view as it leaves the blind spot mirror (C).

## Blind Spot Information System (If Equipped)

See **Blind Spot Information System** (page 219).

## INTERIOR MIRROR

### WARNING



Do not adjust the mirror when your vehicle is moving.

**Note:** Do not clean the housing or glass of any mirror with harsh abrasives, fuel or other petroleum or ammonia-based cleaning products.

You can adjust the interior mirror to your preference. Some mirrors also have a second pivot point. This lets you move the mirror head up or down and from side to side.

Pull the tab below the mirror toward you to reduce glare at night.

## Auto-Dimming Mirror (If Equipped)

**Note:** Do not block the sensors on the front and back of the mirror. Mirror performance may be affected. A rear center passenger or raised rear center head restraint may also block light from reaching the sensor.

The mirror will dim automatically to reduce glare when bright lights are detected from behind your vehicle. It will automatically return to normal reflection when you select reverse gear to make sure you have a clear view when backing up.

## SUN VISORS

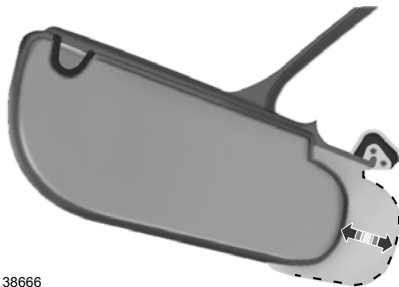

E138666

Rotate the sun visor toward the side window and extend it rearward for extra shade.

## Illuminated Vanity Mirror (If Equipped)

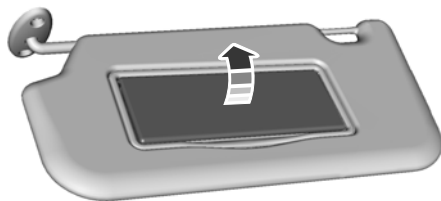

E162197

Lift the cover to switch the lamp on.

# Windows and Mirrors

## MOONROOF (If Equipped)

### WARNINGS

 Do not let children play with the moonroof or leave them unattended in the vehicle. They may seriously hurt themselves.

 When closing the moonroof, you should verify that it is free of obstructions and make sure that children and pets are not in the proximity of the roof opening.

The moonroof controls are located on the overhead console and have a one-touch open and close feature. To stop it during one-touch operation, press the control a second time.

### Opening and Closing the Sunscreen

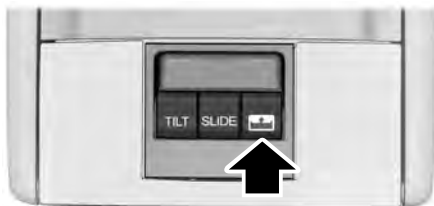

E193983

Press and release the control to open the sunscreen.

**Note:** *The sunscreen stops at the first panel for the dual panel moonroof. Press and release again to continue to open the sunscreen past the second panel.*

Pull and release the control to close the sunscreen. The moonroof, if open, automatically closes prior to closing the sunscreen.

### Opening and Closing the Moonroof

Press and release the **SLIDE** control to open the moonroof. The sunscreen, if closed, automatically opens prior to opening the moonroof. The moonroof stops short of the fully opened position.

**Note:** *This position helps to reduce wind noise or rumbling which may happen with the moonroof fully open. Press and release the control again to fully open the moonroof.*

Pull and release the **SLIDE** control to close the moonroof.

### Bounce-Back

The moonroof stops automatically while closing. It reverses some distance if there is an obstacle in the way.

Pull and hold the **SLIDE** control within two seconds of a bounce-back event to override this function. While bounce-back is active, the closing force increases for each of the next three times that you close the moonroof.

### Venting the Moonroof

Press and release the **TILT** control to vent the moonroof. Pull and hold the **TILT** control to close the moonroof.



# Instrument Cluster

## GAUGES

### Type I

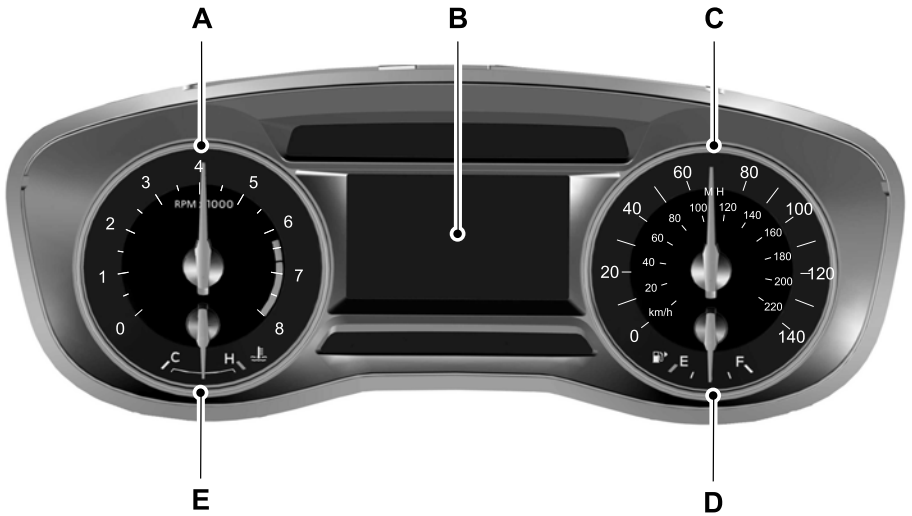

E193714

- A Tachometer.
- B Information display. See **Information Displays** (page 99).
- C Speedometer.
- D Fuel gauge.
- E Engine coolant temperature gauge.

# Instrument Cluster

---

## Type 2

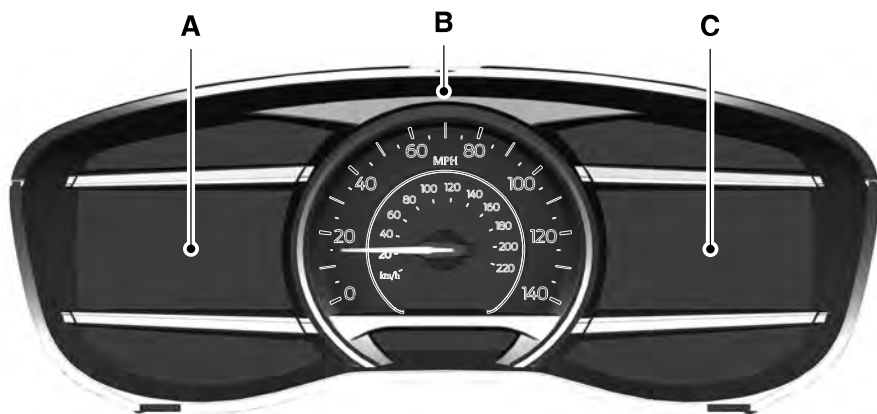

E193715

- A Left information display. See **Information Displays** (page 99).
- B Speedometer.
- C Right information display.

# Instrument Cluster

## Type 3

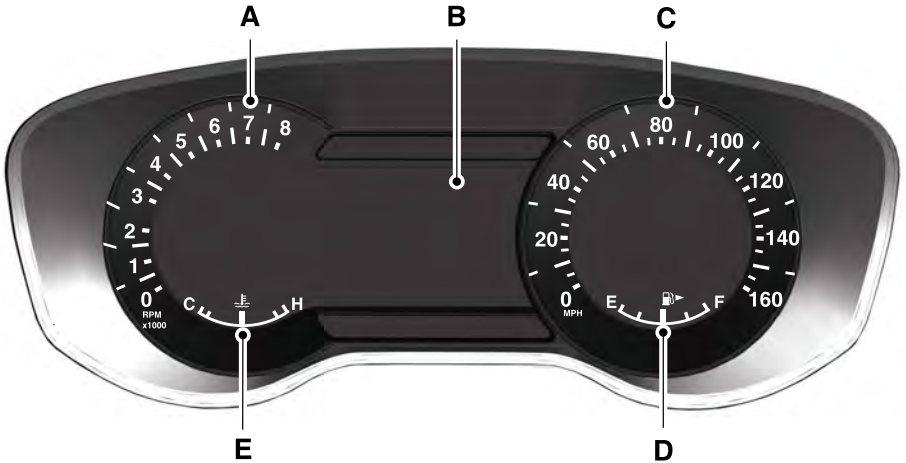

E203205

- A Tachometer.
- B Information display. See **Information Displays** (page 99).
- C Speedometer.
- D Fuel gauge.
- E Engine coolant temperature gauge.

### Information Display

#### Odometer

Located in the bottom of the information display. Registers the accumulated distance your vehicle has traveled.

#### Compass

Displays the vehicle's heading direction.

### Trip Computer

See **General Information** (page 99).

### Vehicle Settings and Personalization

See **General Information** (page 99).

# Instrument Cluster

## Engine Coolant Temperature Gauge

Shows the temperature of the engine coolant. At normal operating temperature, the needle will remain in the center section. If the needle enters the red section, the engine is overheating. Stop the engine, switch the ignition off and determine the cause once the engine has cooled down.

**Note:** *Do not restart the engine until the cause of the overheating has been resolved.*

### WARNING



Never remove the coolant reservoir cap while the engine is running or hot.

## Fuel Gauge

**Note:** *The fuel gauge may vary slightly when your vehicle is moving or on a gradient.*

Switch the ignition on. The fuel gauge will indicate approximately how much fuel is left in the fuel tank. The arrow adjacent to the fuel pump symbol indicates on which side of your vehicle the fuel filler door is located.

The needle should move toward F when you refuel your vehicle. If the needle points to E after adding fuel, this indicates your vehicle needs service soon.

After refueling some variability in needle position is normal:

- It may take a short time for the needle to reach full after leaving the gas station. This is normal and depends upon the slope of pavement at the gas station.
- The fuel amount dispensed into the tank is a little less or more than the gauge indicated. This is normal and depends upon the slope of pavement at the gas station.

- If the gas station nozzle shuts off before the tank is full, try a different gas pump nozzle.
- There is a small reserve left in the tank when the fuel gauge reaches empty.

## Low Fuel Reminder

A low fuel reminder triggers when the distance to empty reaches 75 miles (120 km), 50 miles (80 km), 25 miles (40 km), 10 miles (20 km) and 0 miles (0 km).

### Variations:

**Note:** *The low fuel warning and distance-to-empty warning can appear at different fuel gauge positions depending on fuel economy conditions. This variation is normal.*

## WARNING LAMPS AND INDICATORS

The following warning lamps and indicators alert you to a vehicle condition that may become serious. Some lamps illuminate when you start your vehicle to make sure they work. If any lamps remain on after starting your vehicle, refer to the respective system warning lamp for further information.

**Note:** *Some warning indicators appear in the information display and function the same as a warning lamp, but do not display when you start your vehicle.*

## Adaptive Cruise Control (If Equipped)



The speed control system indicator light changes color to indicate what mode the system is in. See **Using Adaptive Cruise Control** (page 209).

# Instrument Cluster

On (white light): Illuminates when you switch on the adaptive cruise control system. Turns off when the speed control system is turned off.

Engaged (green light): Illuminates when you engage the adaptive cruise control system. Turns off when you disengage the speed control system.

## Anti-Lock Braking System



If it illuminates when you are driving, this indicates a malfunction. You continue to have the normal braking system (without ABS) unless the brake system warning lamp is also illuminated. Have the system checked by an authorized dealer.

## Automatic High Beam Control



It will illuminate when this feature is on. See **Automatic High Beam Control** (page 82).

## Battery



If it illuminates while driving, it indicates a malfunction. Switch off all unnecessary electrical equipment and have the system checked by an authorized dealer immediately.

## Blind Spot Monitor (If Equipped)



It illuminates when you switch this feature off or in conjunction with a message. See **Blind Spot Information System** (page 219).

## Brake System



It illuminates when you engage the parking brake with the ignition on.

If it illuminates when you are driving, check that the parking brake is not engaged. If the parking brake is not engaged, this indicates low brake fluid level or a brake system malfunction. Have the system checked immediately by an authorized dealer.

## WARNING



Driving your vehicle with the warning lamp on is dangerous. A significant decrease in braking performance may occur. It will take you longer to stop your vehicle. Have your vehicle checked by your authorized dealer immediately. Driving extended distances with the parking brake engaged can cause brake failure and the risk of personal injury.

## Cruise Control (If Equipped)



It illuminates when you switch this feature on.

## Direction Indicator



Illuminates when you switch on the left or right direction indicator or the hazard warning flasher. If the indicators stay on or flash faster, check for a burned out bulb. See **Changing a Bulb** (page 291).

## Door Ajar



Displays when the ignition is on and any door is not completely closed.

## Engine Coolant Temperature



Illuminates when the engine coolant temperature is high. Stop the vehicle as soon as possible, switch off the engine and let cool. See **Engine Coolant Check** (page 280).

# Instrument Cluster

## Engine Oil



If it illuminates with the engine running or when you are driving, this indicates a malfunction.

Stop your vehicle as soon as it is safe to do so and switch the engine off. Check the engine oil level. See **Engine Oil Check** (page 278).

**Note:** Do not resume your journey if it illuminates despite the level being correct. Have the system checked by an authorized dealer immediately.

## Fasten Safety Belt



It illuminates and a chime sounds to remind you to fasten your safety belt. See **Seatbelt Reminder** (page 37).

## Front Airbag



If it fails to illuminate when you start your vehicle, continues to flash or remains on, it indicates a malfunction. Have the system checked by an authorized dealer.

## Front Fog Lamps (If Equipped)



Lights when you switch the front fog lamps on.

## Heads Up Display (If Equipped)



A red beam of lights illuminates on the windshield in certain instances when using adaptive cruise control and/or the collision warning system. It also illuminates momentarily when you start your vehicle to make sure the display works.

## High Beam



It illuminates when you switch the high beam headlamps on. It flashes when you use the headlamp flasher.

## Hood Ajar



Displays when the ignition is on and the hood is not completely closed.

## Lane Keeping Aid (If Equipped)



Lights when the lane keeping system is activated.

## Liftgate Ajar



Lights when the liftgate is not completely closed.

## Low Fuel Level



It illuminates when the fuel level is low or the fuel tank is nearly empty. Refuel as soon as possible.

## Low Tire Pressure Warning



It illuminates when your tire pressure is low. If the lamp remains on with the engine running or when driving, check your tire pressure as soon as possible.

It also illuminates momentarily when you switch the ignition on to confirm the lamp is functional. If it does not illuminate when you switch the ignition on, or begins to flash at any time, have the system checked by an authorized dealer.

# Instrument Cluster

## Low Washer Fluid



It illuminates when the windshield washer fluid is low.

## Parking Lamps



It illuminates when you switch the parking lamps on.

## Powertrain Fault



It illuminates when the system detects a powertrain or an 4WD fault. Contact an authorized dealer as soon as possible.

## Service Engine Soon



If the service engine soon indicator light stays illuminated after you start the engine, it indicates that the On Board Diagnostics system (OBD) has detected a malfunction of the vehicle emissions control system. Refer to On board diagnostics (OBD) in the Fuel and Refueling chapter for more information about having your vehicle serviced. See **Emission Control System** (page 174).

If the light is blinking, engine misfire is occurring which could damage your catalytic converter. Drive in a moderate fashion (avoid heavy acceleration and deceleration) and have your vehicle serviced immediately.

### WARNING



Under engine misfire conditions, excessive exhaust temperatures could damage the catalytic converter, the fuel system, interior floor coverings or other vehicle components, possibly causing a fire. Have an authorized dealer service your vehicle immediately.

The service engine soon indicator light illuminates when you first switch on the ignition before engine start to check the bulb and to indicate whether the vehicle is ready for Inspection/Maintenance (I/M) testing.

Normally, the service engine soon light stays on until you crank the engine, then turns itself off if no malfunctions are present. However, if after 15 seconds the service engine soon light blinks eight times, it means that the vehicle is not ready for I/M testing. See **Emission Control System** (page 174).

## Stability Control



It flashes when the system is active. If it remains illuminated or does not illuminate when you switch the ignition on, this indicates a malfunction. During a malfunction the system switches off. Have the system checked by an authorized dealer immediately. See **Using Stability Control** (page 190).

## Stability Control Off



It illuminates when you switch the system off. It goes out when you switch the system back on or when you switch the ignition off. See **Using Stability Control** (page 190).

## Transmission Tow/Haul (If Equipped)



It illuminates when you activate the tow/haul feature. If the light flashes steadily, have the system serviced immediately. Damage to the transmission could occur. See **Automatic Transmission** (page 177).

# Instrument Cluster

---

## AUDIBLE WARNINGS AND INDICATORS

### Key in Ignition Warning Chime

Sounds when you open the driver's door and you have left the key in the ignition.

### Engine On Warning Chime

A warning chime will sound when any door is opened if the vehicle exceeds a relatively low speed.

### Keyless Warning Alert *(If Equipped)*

Sounds the horn twice when you exit the vehicle and the keyless vehicle is in RUN, indicating the vehicle is still on.

### Headlamps On Warning Chime

Sounds when you remove the key from the ignition and open the driver's door and you have left the headlamps or parking lamps on.

### Parking Brake On Warning Chime

Sounds when you have left the parking brake on and drive your vehicle. If the warning chime remains on after you have released the parking brake, have the system checked by your authorized dealer immediately.

### Automatic Transmission Warning Chime

Sounds when you have not moved the transmission selector lever to position **P**. A message will be shown in the display.



# Information Displays

## GENERAL INFORMATION

### WARNING



Driving while distracted can result in loss of vehicle control, crash and injury. We strongly recommend that you use extreme caution when using any device that may take your focus off the road. Your primary responsibility is the safe operation of your vehicle. We recommend against the use of any hand-held device while driving and encourage the use of voice-operated systems when possible. Make sure you are aware of all applicable local laws that may affect the use of electronic devices while driving.

You can control various systems on your vehicle using the information display controls on the steering wheel. Corresponding information appears in the information display.

## Information Display Controls (Type 1)

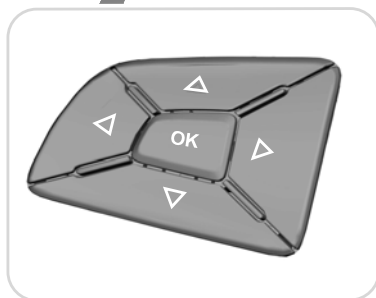

E193720

- Press the up and down arrow buttons to scroll through and highlight the options within a menu.
- Press the right arrow button to enter a submenu.
- Press the left arrow button to exit a submenu.
- Press the **OK** button to choose and confirm settings or messages.

### Trip 1 & 2

You can access the menu using the information display control.

**Note:** *Some options may appear slightly different or not at all if the items are optional.*

# Information Displays

| Trip 1 & 2  |
|---|
| Digital Speedo  |
| Distance to E   |
| Trip Odometer   |
| Trip Timer  |
| Fuel Used   |
| Average Fuel  |
| All Values  |
| Total Odometer (located in the lower right of the display)* |

\*This also displays in other menus.

- Digital Speedo - Shows a digital display of your vehicle speed.
  - Distance to E — Shows the approximate distance your vehicle can travel before running out of fuel.
  - Trip Odometer — Registers the distance of individual journeys.
  - Trip Timer — The timer stops when you turn your vehicle off and restarts when you restart your vehicle.
  - Fuel Used — Shows the amount of fuel used for a given trip.
  - Average Fuel — Shows the average fuel economy for a given trip.
  - All Values — Shows the Distance to E, Trip Odometer, Trip Timer and Average Fuel.
- Note:** Press and hold **OK** on the current screen to reset the respective trip, distance, time and fuel information.

## Fuel Economy

| Information                |
|----------------------------|
| Distance to Empty          |
| Instantaneous Fuel Economy |
| Average MPG                |
| Fuel History               |
| All Values                 |

# Information Displays

- Distance to Empty - Shows the approximate distance your vehicle can travel before running out of fuel.
- Instantaneous Fuel Economy - Shows a visual graph of your instantaneous fuel economy along with your Avg MPG since the function was last reset.
- Average MPG — Shows the average fuel economy since last reset.
- Fuel History - Shows a bar chart of your fuel history.
- All Values — Shows all fuel economy values (DTE, Inst Fuel Econ, Avg Fuel).

**Note:** You can reset your average fuel economy by pressing and holding the **OK** button on the left hand steering wheel controls.

## Driver Assist

In this mode, you can configure different driver setting choices.

**Note:** Some options may appear slightly different or not at all if the items are optional.

| Driver Assist   |                       |                          |
|---|-----------------------|--------------------------|
| Traction Ctrl - check enabled or uncheck disabled     |                       |                          |
| Blind Spot - check enabled or uncheck disabled        |                       |                          |
| Cross Traffic - check enabled or uncheck disabled     |                       |                          |
| Cruise Control  | Adaptive or Normal    |                          |
| Driver Alert - check enabled or uncheck disabled      |                       |                          |
| Hill Start Assist - check enabled or uncheck disabled |                       |                          |
| Intelligent 4WD with Terrain Management System        |                       |                          |
| Lane Keeping System                                   | Mode                  | Alert, Aid or Alert +Aid |
|   | Intensity             | High, Normal or Low      |
| Pre-Collision   | Alert Sensitivity     | High, Normal or Low      |
| Rear Park Aid - check enabled uncheck disabled        |                       |                          |
| Tire Pressure   | 4 Wheel Tire Pressure |                          |
| Trailer Sway - check enabled or uncheck disabled      |                       |                          |

## Settings

In this mode, you can configure different driver setting choices.

**Note:** Some items are optional and may not appear.

# Information Displays

| <b>Settings</b> |   |  |                            |  |
|-----------------|---|--|----------------------------|--|
| Vehicle         | Alarm   | All Sensors  |                            |  |
|                 |   | Perimeter Sensing                                    |                            |  |
|                 |   | Ask on Exit  |                            |  |
|                 | Auto Engine Off - check enabled uncheck disabled    |  |                            |  |
|                 | Chimes  | Information - check enabled or uncheck disabled      |                            |  |
|                 | DTE Calculation                                     | Normal or Towing                                     |                            |  |
|                 | Easy Entry/Exit - check enabled or uncheck disabled |  |                            |  |
|                 | Lighting  | Auto Highbeam - check enabled or uncheck disabled    |                            |  |
|                 |   | Autolamp Delay                                       | Off or XX Seconds          |  |
|                 |   | Daytime Lights - check enabled or uncheck disabled   |                            |  |
|                 | Locks   | Autolock - check enabled or uncheck disabled         |                            |  |
|                 |   | Autounlock - check enabled or uncheck disabled       |                            |  |
|                 |   | Relock - check enabled or uncheck disabled           |                            |  |
|                 |   | Remote unlock  | All Doors or Driver's Door |  |
|                 |   | Switches Inhibit - check enabled or uncheck disabled |                            |  |
|                 | Mirrors   | Autofold - check enabled or uncheck disabled         |                            |  |
|                 | Oil Life Reset                                      | Remaining Life XXX% - Hold OK to Reset               |                            |  |
|                 | Power Lift-gate                                     | Enable Switch or Disable Switch                      |                            |  |
|                 | Remote Start  | Climate Control                                      | Auto or Last Settings      |  |
|                 |   | Seats or Seats and Wheel                             | Automatic or Off           |  |
|                 |   | Duration   | 5, 10 or 15 minutes        |  |
|                 |   | System - check enabled or uncheck disabled           |                            |  |
|                 | Wipers  | Courtesy Wipe or Rain Sensing                        |                            |  |

## Information Displays

| <b>Settings</b> |  |   |
|-----------------|--|---|
| MyKey           | MyKey Status                                       | MyKey Qty<br>MyKey Odo<br>Admin Key Qty |
|                 | Create MyKey                                       | Hold OK to Create MyKey                 |
|                 | 911 Assist   | Always On or User Selectable            |
|                 | Do Not Disturb                                     | On or Off                               |
|                 | Traction Control                                   | Always On or User Selectable            |
|                 | Max Speed  | Choose desired speed or off             |
|                 | Volume Limiter - check enabled or uncheck disabled |   |
|                 | Clear MyKeys                                       | Hold OK to Clear All MyKeys             |
| Display Setup   | Distance   | Miles & Gallons, L/100km or km/L        |
|                 | Temperature  | Fahrenheit (°F) or Celsius (°C)         |
|                 | Tire Pressure                                      | psi, kPa or bar                         |
|                 | Language   | Choose your applicable setting          |

**Note:** Some MyKey items only appear if a MyKey is set.

# Information Displays

## Information Display Controls (Type 2)

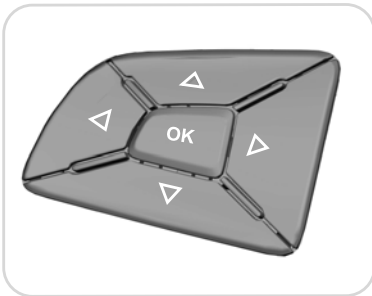
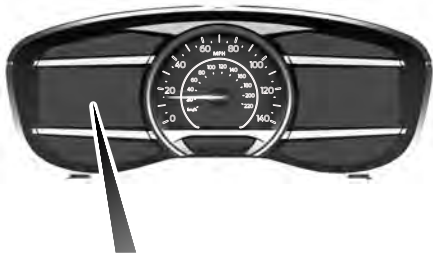

E193721

- Press the up and down arrow buttons to scroll through and highlight the options within a menu.
- Press the right arrow button to enter a sub-menu.

- Press the left arrow button to exit a menu.
- Press and hold the left arrow button at any time to return to the main menu display (escape button).
- Press the **OK** button to choose and confirm settings or messages.

### Main Menu

From the main menu bar on the left side of the information display, you can choose from the following categories:

- Display Mode.
- Trip 1 & 2.
- Fuel Economy.
- Driver Assist.
- Settings.

Scroll up or down to highlight one of the categories and then press the right arrow key or OK to enter into that category. Press the left arrow key as needed to exit back to the main menu.

### Display Mode

Use the up or down arrow buttons to choose between the following display options.

| Display Mode         |           |          |          |           |
|----------------------|-----------|----------|----------|-----------|
| Display mode         | Option 1* | Option 2 | Option 3 | Option 4* |
| XXX mi (km) to empty | X         | X        | -        | -         |
| Round tachometer     | -         | -        | X        | X         |
| Vertical tachometer  | -         | X        | -        | -         |

# Information Displays

| Display Mode   |
|--|
| Tire pressure on demand screen                             |
| Digital speedometer - XXX MPH - Press OK for km/h          |
| Intelligent 4WD - 4WD Gauge with Terrain Management System |

\*Vehicles with Intelligent 4WD only. You can choose to have only the fuel gauge show in this mode. Refer to Display > Gauge Display found in the table under the Settings section later in this chapter.

## **XXX mi (km) to empty**

Shows approximate fuel level before the fuel tank reaches empty. The value is dynamic and can change (raise or lower) depending on driving style.

## **Fuel gauge**

Switch the ignition on. The fuel gauge indicates approximately how much fuel is in the fuel tank. The arrow next to the fuel pump symbol shows the fuel filler door side of your vehicle. When the fuel level becomes low, the level indicator changes to amber. When the fuel level becomes critically low, the level indicator changes to red.

**Note:** *The fuel gauge level may vary slightly when your vehicle is moving or when driving on a slope.*

**Note:** *When a MyKey is in use, low fuel warnings display earlier.*

## **Bar or Round tachometer**

Indicates the engine speed in revolutions per minute. Driving with your tachometer pointer continuously at the top of the scale may damage the engine. During SelectShift Automatic™ transmission (SST) use, the currently selected gear appears in the display.

## **Engine coolant temperature gauge**

Indicates engine coolant temperature. At normal operating temperature, the level indicator is in the normal range. If the engine coolant temperature exceeds the normal range, stop your vehicle as soon as safely possible, switch off the engine and let the engine cool.

## **Intelligent 4WD (if equipped)**

Displays power distribution between the front and rear wheels. More power to either the front or rear wheels displays by more area filled in. Intelligent 4WD also displays the currently selected terrain management mode.

## **Trip 1 & 2**

You can access the menu using the information display control.

**Note:** *Some options may appear slightly different or not at all if the items are optional.*

# Information Displays

## Trip 1 & 2

### All Values

- All Values — shows all trip values (Trip Timer, Trip Odometer and Average Fuel).
- Trip Odometer — Shows your accumulated trip distance.
- Average Fuel — Shows your average fuel economy for a given trip.
- Trip Timer— The timer stops when you turn your vehicle off and restarts when you restart your vehicle.

**Note:** You can reset your trip information by pressing and holding the OK button on the left hand steering wheel controls.

### Fuel Economy

Use the left or right arrow buttons to choose the desired fuel economy display.

## Fuel Economy

### Inst Fuel Economy - Hold OK to Reset

### Fuel History

- Inst Fuel Economy - shows a visual graph of your instantaneous fuel economy, average fuel economy and distance to empty.
- Fuel History - shows a bar chart of your fuel history from the past 30 min, average fuel economy and distance to empty.

**Note:** You can reset your average fuel economy by pressing and holding the OK button on the left hand steering wheel controls.

### Driver Assist

In this mode, you can configure different driver setting choices.

**Note:** Some items are optional and may not appear.

## Driver Assist

Traction Control - check enabled or uncheck disabled

Blindspot - check enabled or uncheck disabled

Cross Traffic Alert- check enabled or uncheck disabled

|                |                    |   |
|----------------|--------------------|---|
| Cruise Control | Adaptive or Normal | — |
|----------------|--------------------|---|

Driver Alert - check enabled or uncheck disabled

Hill Start Assist - check enabled or uncheck disabled



## Information Displays

| <b>Driver Assist</b>                              |                   |                     |
|---|-------------------|---------------------|
| Lane Keeping                                      | Mode              | Alert, Aid or Both  |
|   | Intensity         | High, Normal or Low |
| Pre-Collision                                     | Alert Sensitivity | High, Normal or Low |
| Rear Park Aid - check enabled or uncheck disabled |                   |                     |
| Trailer Sway - check enabled or uncheck disabled  |                   |                     |

### Settings

**Note:** *Some items are optional and may not appear.*

In this mode, you can configure different driver setting choices.

| <b>Settings</b> |   |  |                            |
|-----------------|---|--|----------------------------|
| Vehicle         | Alarm   | Settings   |                            |
|                 |   | Perimeter Sensing                                  |                            |
|                 |   | Ask on Exit - check enabled or uncheck disabled    |                            |
|                 | Auto Engine Off - check enabled or uncheck disabled |  |                            |
|                 | DTE Calculation                                     | Normal or Towing                                   |                            |
|                 | Easy Entry/Exit - check enabled or uncheck disabled |  |                            |
|                 | Lighting  | Auto Highbeam                                      | On or Off                  |
|                 |   | Autolamp Delay                                     | Off or XX Seconds          |
|                 |   | Daytime Lights - check enabled or uncheck disabled |                            |
|                 | Locks   | Autolock - check enabled or uncheck disabled       |                            |
|                 |   | Autounlock - check enabled or uncheck disabled     |                            |
|                 |   | Relock - check enabled or uncheck disabled         |                            |
|                 |   | Remote Unlock                                      | All doors or Driver's door |
|                 |   | Switch Inhibit - check enabled or uncheck disabled |                            |
|                 | Mirrors   | Autofold - check enabled or uncheck disabled       |                            |
| Oil Life Reset  | XXX% - Hold OK to Reset                             |  |                            |

# Information Displays

| <b>Settings</b>                                  |  |   |                       |
|--|--|---|-----------------------|
|  | Power Lift-gate                                    | Enable Switch or Disable Switch                   |                       |
|  | Remote Start                                       | Climate Control                                   | Auto or Last Settings |
|  |  | Seats or Seats and Wheel                          | Auto or Off           |
|  |  | Duration  | 5, 10 or 15 minutes   |
|  |  | System - check enabled or uncheck disabled        |                       |
|  | Wipers   | Courtesy Wipe - check enabled or uncheck disabled |                       |
| Rain Sensing - check enabled or uncheck disabled |  |   |                       |
| MyKey  | MyKey  | MyKeys Qty<br>MyKey Odometer<br>Admin Key Qty     |                       |
|  | Create MyKey                                       | Hold OK to Create MyKey                           |                       |
|  | 911 Assist   | Always On or User Selectable                      |                       |
|  | Do Not Disturb                                     | Always On or User Selectable                      |                       |
|  | AdvancTrac   | Always On or User Selectable                      |                       |
|  | MAX Speed  | Choose desired speed or off                       |                       |
|  | Speed Minder                                       | Choose desired speed or off                       |                       |
|  | Volume Limiter - check enabled or uncheck disabled |   |                       |
|  | Clear MyKeys                                       | Hold OK to Clear All MyKeys                       |                       |
| Display Settings                                 | Distance   | Miles & Gallons, l/100km or km/l                  |                       |
|  | Temperature  | Fahrenheit (°F) or Celsius (°C)                   |                       |

# Information Displays

| Settings |               |                                |
|----------|---------------|--------------------------------|
|          | Gauge Display | Fuel Gauge or Fuel + Tach      |
|          | Tire Pressure | psi, kPa or bar                |
|          | Language      | Choose your applicable setting |

**Note:** Some MyKey items only appear if a MyKey is set.

## Information Display Controls (Type 3)

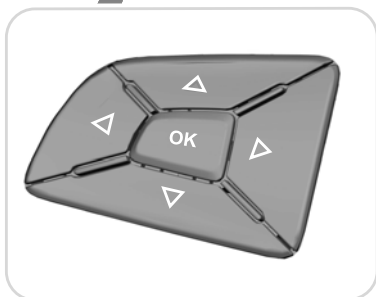
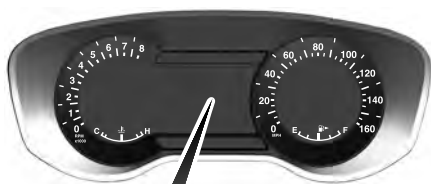

E203206

- Press and hold the left arrow button at any time to return to the main menu display (escape button).
- Press the **OK** button to choose and confirm settings or messages.

- Press the up and down arrow buttons to scroll through and highlight the options within a menu.
- Press the right arrow button to enter a sub-menu.
- Press the left arrow button to exit a menu.

## Main Menu

From the main menu bar on the left side of the information display, you can choose from the following categories:

- Trip 1 & 2.
- Fuel Economy.
- Driver Assist.
- Settings.

Scroll up or down to highlight one of the categories and then press the right arrow key or **OK** to enter into that category. Press the left arrow key as needed to exit back to the main menu.

## Trip 1 & 2

You can access the menu using the information display control.

**Note:** Some options may appear slightly different or not at all if the items are optional.

# Information Displays

## Trip 1 & 2

### All Values

- All Values — shows all trip values (Trip Timer, Trip Odometer and Average Fuel).
- Trip Odometer — Shows your accumulated trip distance.
- Average Fuel — Shows your average fuel economy for a given trip.
- Trip Timer— The timer stops when you turn your vehicle off and restarts when you restart your vehicle.

**Note:** You can reset your trip information by pressing and holding the OK button on the left hand steering wheel controls.

### Fuel Economy

Use the left or right arrow buttons to choose the desired fuel economy display.

## Fuel Economy

### Instant Fuel Economy - Hold OK to Reset

### Fuel History

- Inst Fuel Economy - shows a visual graph of your instantaneous fuel economy, average fuel economy and distance to empty.
- Fuel History - shows a bar chart of your fuel history from the past 30 min, average fuel economy and distance to empty.

**Note:** You can reset your average fuel economy by pressing and holding the OK button on the left hand steering wheel controls.

### Driver Assist

In this mode, you can configure different driver setting choices.

**Note:** Some items are optional and may not appear.

## Driver Assist

Traction Control - check enabled or uncheck disabled

Intelligent 4WD

Intelligent 4WD with Terrain Management System

Blindspot - check enabled or uncheck disabled

Cross Traffic - check enabled or uncheck disabled

Cruise Control

Adaptive or Normal

—

Driver Alert - check enabled or uncheck disabled

# Information Displays

| Driver Assist   |                               |                     |
|---|-------------------------------|---------------------|
| Hill Start Assist - check enabled or uncheck disabled |                               |                     |
| Lane Keeping  | Mode                          | Alert, Aid or Both  |
|   | Intensity                     | High, Normal or Low |
| Pre-Collision   | Alert Sensitivity             | High, Normal or Low |
| Rear Park Aid - check enabled or uncheck disabled     |                               |                     |
| Tire Pressure   | 4 Wheel Tire Pressure Display |                     |
| Trailer Sway - check enabled or uncheck disabled      |                               |                     |

**Note:** Some items are optional and may not appear.

## Settings

In this mode, you can configure different driver setting choices.

| Settings |   |  |                          |
|----------|---|--|--------------------------|
| Vehicle  | Alarm   | Settings   |                          |
|          |   | Perimeter Sensing                                  |                          |
|          |   | Ask on Exit - check enabled or uncheck disabled    |                          |
|          | DTE Calculation                                     | Normal or Towing                                   |                          |
|          | Chimes  | Information - check enabled or uncheck disabled    |                          |
|          | Easy Entry/Exit - check enabled or uncheck disabled |  |                          |
|          | Auto Engine Off - check enabled or uncheck disabled |  |                          |
|          | Lighting  | Auto Highbeam - check enabled or uncheck disabled  |                          |
|          |   | Autolamp Delay                                     | Off or XX Seconds        |
|          |   | Daytime Lights - check enabled or uncheck disabled |                          |
|          | Locks   | Autolock - check enabled or uncheck disabled       |                          |
|          |   | Autounlock - check enabled or uncheck disabled     |                          |
|          |   | Relock - check enabled or uncheck disabled         |                          |
|          |   | Remote Unlock                                      | All doors or Driver door |

## Information Displays

| <b>Settings</b>  |                  |  |
|------------------|------------------|--|
|                  |                  | Switch Inhibit - check enabled or uncheck disabled |
|                  | Mirrors          | Autofold - check enabled or uncheck disabled       |
|                  | Oil Life Reset   | XXX% - Hold OK to Reset                            |
|                  | Power Lift-gate  | Enable Switch or Disable Switch                    |
|                  | Remote Start     | Climate Control                                    |
|                  |                  | Auto or Last Settings                              |
|                  |                  | Seats or Seats and Wheel                           |
|                  |                  | Auto or Off  |
|                  | Duration         | 5, 10 or 15 minutes                                |
|                  |                  | System - check enabled or uncheck disabled         |
|                  | Wipers           | Courtesy Wipe - check enabled or uncheck disabled  |
|                  |                  | Rain Sensing - check enabled or uncheck disabled   |
| MyKey            | Mykey Status     | MyKeys Qty<br>MyKey Odometer<br>Admin Key Qty      |
|                  | Create MyKey     | Hold OK to Create MyKey                            |
|                  | 911 Assist       | Always On or User Selectable                       |
|                  | Do Not Disturb   | On or Off  |
|                  | Traction Control | Always On or User Selectable                       |
|                  | Max Speed        | Choose desired speed or off                        |
|                  | Speed Minder     | Choose desired speed or off                        |
|                  |                  | Volume Limiter - check enabled or uncheck disabled |
|                  | Clear MyKeys     | Hold OK to Clear All MyKeys                        |
| Display Settings | Distance         | Miles & Gallons, l/100km or km/l                   |

# Information Displays

| Settings |               |  |
|----------|---------------|--|
|          | Temperature   | Fahrenheit (°F) or Celsius (°C)                      |
|          | Tire Pressure | psi, kPa or bar                                      |
|          | Language      | Choose your applicable setting                       |
|          | Speedometer   | Speedometer km/h - check enabled or uncheck disabled |

**Note:** Some MyKey items only appear if a MyKey is set.

## INFORMATION MESSAGES

**Note:** Depending on the vehicle options equipped with your vehicle, not all of the messages will display or be available. Certain messages may display abbreviated or shortened depending upon which cluster type you have.

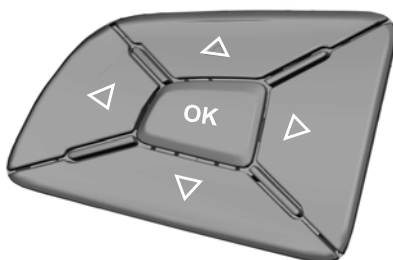

E203207

Press the OK button to acknowledge and remove some messages from the information display. Other messages delete automatically after a short time.

You need to confirm certain messages before you can access the menus.

## 4WD

| Message                  | Action  |
|--------------------------|---|
| 4WD Temporarily Disabled | The four wheel drive system has automatically disabled itself due to the system overheating.  |
| 4WD Off                  | The four wheel drive system has automatically disabled itself due to the system overheating or you are using the spare tire.  |
| 4WD Restored             | The four wheel drive system resumes normal function and clears this message after driving a short distance with the road tire re-installed or after the system cools. |

## Information Displays

| Message                                 | Action  |
|---|---|
| 4WD Malfunction Service Required        | The four wheel drive system is not operating properly and the powertrain fault indicator illuminates. See <b>Warning Lamps and Indicators</b> (page 94). If the warning stays illuminated or continues to illuminate, contact an authorized dealer as soon as possible. |
| Change 4WD Power Transfer Unit Lube     | Displayed when the transfer case fluid requires service.  |
| 4WD Power Transfer Unit Lube Set to New | Displayed when the transfer case fluid has been changed and reset to new.   |

### Adaptive Cruise Control

| Message   | Action  |
|---|---|
| Adaptive Cruise Malfunction                             | A radar malfunction is preventing the adaptive cruise from engaging. See <b>Using Adaptive Cruise Control</b> (page 209).   |
| Adaptive Cruise Not Available                           | Conditions exist such that the adaptive cruise cannot function properly. See <b>Using Adaptive Cruise Control</b> (page 209).   |
| Adaptive Cruise Not Available Sensor Blocked See Manual | The radar is blocked because of poor radar visibility due to bad weather or ice/mud/water in front of radar. Driver can typically clean the sensor to resolve. See <b>Using Adaptive Cruise Control</b> (page 209). |

### AdvanceTrac™

| Message             | Action  |
|---------------------|---|
| Service AdvanceTrac | The system detects a malfunction due to a blocked sensor. |
| AdvanceTrac Off On  | The driver has disabled or enabled the traction control.  |

### Alarm

| Message                                    | Action   |
|--|--|
| Vehicle Alarm To Stop Alarm, Start Vehicle | Unauthorized entry triggered the alarm. See <b>Anti-Theft Alarm</b> (page 70). |



# Information Displays

---

## Automatic Engine Shutdown

| <b>Message</b>                                      | <b>Action</b>   |
|---|---|
| Engine Shuts Off In XX Seconds                      | The engine is preparing to shutdown.  |
| Engine Shut Off For Fuel Economy                    | The engine has shutdown to help increase fuel economy.  |
| Engine Shuts Off in XX Seconds Press OK to Override | The engine is preparing to shutdown. You can press OK on the left steering wheel button to override the shutdown. |

## Automatic High Beam Control

| <b>Message</b>                            | <b>Action</b>   |
|---|---|
| Front Camera Low Visibility Clean Screen  | The front camera sensor has reduced visibility. Clean the windshield.                               |
| Front Camera Malfunction Service Required | The system requires service due to a malfunction. Contact an authorized dealer.                     |
| Front Camera Temporarily Not Available    | The front camera sensor has malfunctioned. Wait a short period of time for the sensor to cool down. |

# Information Displays

## Battery and Charging System

| Message                                     | Action  |
|---|---|
| Check Charging System                       | The charging system needs servicing. If the warning stays on or continues to come on, contact an authorized dealer as soon as possible.   |
| Low Battery Features Temporarily Turned Off | The battery management system detects an extended low voltage condition. Your vehicle will disable various features to help preserve the battery. Turn off as many of the electrical loads as soon as possible to improve the system voltage. Once the system voltage recovers, the disabled features will operate as normal.                     |
| Turn Power Off to Save Battery              | The battery management system determines that the battery is at a low state of charge. Switch the ignition off as soon as possible to protect the battery. This message clears once you start the vehicle and the battery state of charge has recovered. Turning off unnecessary electrical loads allows faster battery state-of-charge recovery. |

## Blind Spot Information and Cross Traffic Alert System

| Message   | Action   |
|---|--|
| Blindspot System Fault                            | A fault with the system has occurred. Contact an authorized dealer as soon as possible.  |
| Blindspot Not Available Sensor Blocked See Manual | The system sensors are blocked. Contact an authorized dealer as soon as possible. See <b>Blind Spot Information System</b> (page 219).     |
| Vehicle Coming From X                             | The system detects a vehicle. See <b>Blind Spot Information System</b> (page 219).   |
| Cross Traffic Not Available Sensor Blocked        | The blind spot information system and cross traffic alert system sensors are blocked. See <b>Blind Spot Information System</b> (page 219). |
| Cross Traffic System Fault                        | A fault with the system has occurred. Contact an authorized dealer as soon as possible.  |

# Information Displays

## Brake System

| Message               | Action  |
|-----------------------|---|
| Brake Fluid Level LOW | The brake fluid level is low. Check the brake system immediately. See <b>Brake Fluid Check</b> (page 285).  |
| Check Brake System    | The brake system needs servicing. Stop the vehicle in a safe place. Contact an authorized dealer.   |
| Park Brake Engaged    | The parking brake is set, the engine is running and you drive your vehicle more than 3 mph (5 km/h). If the warning stays on after you release the parking brake, contact an authorized dealer as soon as possible. |

## Collision Warning System

| Message   | Action  |
|---|---|
| Collision Warning Malfunction                             | There is a system malfunction with the collision warning system. The system is disabled. Contact an authorized dealer as soon as possible.  |
| Collision Warning Not Available Sensor Blocked See Manual | The collision warning system radar is blocked because of poor radar visibility due to bad weather or ice/mud/water in front of the radar. Driver can typically clean the sensor to resolve. Contact an authorized dealer as soon as possible. |
| Collision Warning Not Available                           | There is a system malfunction with the collision warning system. The system is disabled. Contact an authorized dealer as soon as possible.  |

## Doors and Locks

| Message              | Action  |
|----------------------|---|
| Driver Door Ajar     | The driver door is not completely closed.     |
| Passenger Door Ajar  | The passenger door is not completely closed.  |
| Rear Left Door Ajar  | The rear left door is not completely closed.  |
| Rear Right Door Ajar | The rear right door is not completely closed. |
| Liftgate Ajar        | The liftgate is not completely closed.        |

## Information Displays

| Message                          | Action  |
|----------------------------------|---|
| Hood Ajar                        | The hood is not completely closed.  |
| Switches Inhibited Security Mode | The system has disabled the door switches.  |
| Factory Keypad Code XXXXX        | The factory keypad code displays in the information display after the system resets the keypad. See <b>Passive Anti-Theft System</b> (page 69). |

### Driver Alert

| Message                             | Action  |
|-------------------------------------|---|
| Driver Alert Warning Rest Now       | Stop and rest as soon as it is safe to do so. |
| Driver Alert Warning Rest Suggested | Take a rest soon.                             |

### Electronic Stability Control

| Message              | Action  |
|----------------------|---|
| ESC Service required | The system detects a malfunction due to a blocked sensor. |
| ESC Off              | Displays the traction control system status.              |
| ESC On               | Displays the traction control system status.              |

### Engine

| Message                             | Action   |
|-------------------------------------|--|
| High Engine Temperature Stop Safely | Displays when the engine temperature is too high. Stop your vehicle in a safe place and allow the engine to cool. If the problem persists, contact an authorized dealer. See <b>Engine Coolant Check</b> (page 280). |
| Engine Fault Service Now            | Engine service is required. Contact an authorized dealer.  |
| Engine Oil Level Low Check Level    | Check the engine oil level. See <b>Engine Oil Check</b> (page 278).  |

# Information Displays

## Fuel

| Message               | Action  |
|-----------------------|---|
| Fuel Level LOW        | An early reminder of a low fuel condition.      |
| Check Fuel Fill Inlet | The fuel fill inlet may not be properly closed. |

## Hill Descent Control

| Message                                 | Action  |
|---|---|
| Hill Descent Control OFF                | Displays when you deactivate hill descent control mode.                                   |
| For Hill Descent Reduce Speed           | Displays when hill descent speed exceeds 20 mph (32 km/h).                                |
| For Hill Descent Select Gear            | Displays when hill descent control mode requires you to shift the transmission into gear. |
| Hill Descent Driver Resume Control      | Displays when the hill control mode requires you to resume control.                       |
| Hill Descent Control Fault              | Displays when a hill descent system fault is present.                                     |
| Hill Descent Control Off System Cooling | Displays when you disable the hill descent control mode to cool the brake system.         |
| Hill Descent Control Ready              | Displays when you activate the hill descent control mode.                                 |

## Hill Start Assist

| Message                         | Action   |
|---------------------------------|--|
| Hill Start Assist Not Available | Hill start assist is not available. Contact an authorized dealer. See <b>Hill Start Assist</b> (page 186). |

# Information Displays

## Keys and Intelligent Access

| Message                      | Action   |
|------------------------------|--|
| To START Press Brake         | A reminder to press the brake while starting your vehicle.   |
| No Key Detected              | The system does not detect the key. See <b>Keyless Starting</b> (page 162).  |
| Restart Now or Key is Needed | When you press the Start Stop button to shut off the engine, the system does not detect an Intelligent Access key inside your vehicle. |
| Full Accessory Power Active  | Your vehicle is in the run ignition state.   |
| Starting System Fault        | There is a problem with your vehicle's starting system. Contact an authorized dealer for service.                                      |
| Key Program Successful       | You have successfully programmed an intelligent access key to the system.  |
| Key Program Failure          | You have failed to program an intelligent access key to the system.  |
| Max Number of Keys Learned   | You have programmed the maximum number of keys to the system.  |
| Not Enough Keys Learned      | You have not programmed enough keys to the system.   |
| Key Battery Low Replace Soon | The key battery is low. Change the battery as soon as possible. See <b>Remote Control</b> (page 49).                                   |
| Engine ON                    | Informs you that you are exiting your vehicle with the intelligent access key and the engine is on.                                    |

# Information Displays

## Lane Keeping System

| Message  | Action  |
|--|---|
| Lane Keeping Sys. Malfunction Service Required | The system has malfunctioned. Contact an authorized dealer as soon as possible.               |
| Front Camera Temporarily Not Available         | The system has detected a condition that has caused the system to be temporarily unavailable. |
| Front Camera Low Visibility Clean Screen       | The system has detected a condition that requires a clean windshield to operate properly.     |
| Front Camera Malfunction Service Required      | The system has malfunctioned. Contact an authorized dealer as soon as possible.               |
| Keep Hands on Steering Wheel                   | The system requests the driver to keep their hands on the steering wheel.                     |

## Maintenance

| Message                        | Action  |
|--------------------------------|---|
| LOW Engine Oil Pressure        | Stop your vehicle as soon as safely possible. Switch off the engine. Check the oil level. If the warning stays on or continues to come on with your engine running, contact an authorized dealer as soon as possible. |
| Change Engine Oil Soon         | The engine oil life remaining is 10% or less. See <b>Engine Oil Check</b> (page 278).   |
| Oil Change Required            | The oil life left reaches 0%. See <b>Engine Oil Check</b> (page 278).   |
| Engine Coolant Overtemperature | The engine coolant temperature is excessively high.   |
| Washer Fluid Level Low         | The washer fluid is low and needs refilling.  |
| Transport Mode Contact Dealer  | Indicates that your vehicle is still in Transport mode. This may not allow some features to operate properly. Contact an authorized dealer.   |
| Factory Mode Contact Dealer    | Indicates that your vehicle is still in Factory mode. This may not allow some features to operate properly. Contact an authorized dealer.   |

## Information Displays

### MyKey

| Message                          | Action   |
|----------------------------------|--|
| MyKey Not Created                | You cannot program a MyKey during key programming.   |
| MyKey Active Drive Safely        | MyKey is active.   |
| Speed Limited to XX MPH/km/h     | When starting your vehicle, a MyKey is in use and the MyKey speed limit is on.                               |
| Vehicle Near Top Speed           | When a MyKey is in use, the MyKey speed limit is on and your vehicle speed is approaching 80 mph (130 km/h). |
| Check Speed Drive Safely         | MyKey is active.   |
| Buckle Up to Unmute Audio        | A MyKey is in use and Belt-Minder is active.   |
| Could Not Program Integrated Key | You attempted to program a spare key using two existing MyKeys.  |

### Park Aid

| Message               | Action   |
|-----------------------|--|
| Check Park Aid        | The system has detected a condition that requires service. Contact an authorized dealer. See <b>Principle of Operation</b> (page 194). |
| Check Rear Park Aid   | The system has detected a condition that requires service. Contact an authorized dealer. See <b>Principle of Operation</b> (page 194). |
| Front Park Aid On Off | Displays the park aid status.  |
| Rear Park Aid On Off  | Displays the park aid status.  |

### Park Brake

| Message            | Action  |
|--------------------|---|
| Park Brake Engaged | You have set the parking brake and you have driven the vehicle more than 3 mph (5 km/h). If the warning stays on after you have released the parking brake, contact an authorized dealer. |



# Information Displays

## Power Steering

| Message  | Action  |
|--|---|
| Steering Malfunction Service Now   | The power steering system has detected a condition that requires service. Contact an authorized dealer.   |
| Service Power Steering Now   | The power steering system is not working. Stop your vehicle at a safe place. Contact an authorized dealer.  |
| Steering Assist Fault  | The power steering system has detected a condition within the power steering system, or passive entry or passive start system requires service. Contact an authorized dealer. |
| Steering column lock: Remove and re-insert key while turning wheel to unlock | You need to turn the steering wheel in order to disengage the steering lock.  |

## Pre-Collision Warning System

| Message   | Action   |
|---|--|
| Pre-Collision Warning Malfunction                             | A fault with the system has occurred. Contact an authorized dealer.  |
| Pre-Collision Warning Not Available Sensor Blocked See Manual | You have a blocked sensor due to bad weather, ice, mud or water in front of the radar sensor. You can typically clean the sensor to resolve. See <b>Pre-Collision Assist</b> (page 226). |
| Pre-Collision Warning Not Available                           | A fault with the system has occurred. Contact an authorized dealer.  |

## Remote Start

| Message                                     | Action  |
|---|---|
| To Drive: Press Brake and Gear Shift Button | A reminder to apply the brake and push the gearshift button to drive your vehicle after a remote start. |

# Information Displays

## Seats

| Message   | Action   |
|---|--|
| Occupant Sensor<br>BLOCKED Remove<br>Objects Near Passenger<br>Seat | Objects are by the passenger seat. After you move the objects away from the seat, if the warning stays on or continues to come on, contact an authorized dealer as soon as possible. |
| Memory Recall Not<br>Permitted While Driving                        | A reminder that memory seats are not available while driving.  |
| Memory X Saved  | Shows where you have saved your memory setting.  |

## Starting System

| Message                             | Action  |
|-------------------------------------|---|
| To START Press Brake                | A reminder to apply the brake when starting your vehicle.                       |
| Cranking Time Exceeded              | The starter has exceeded its cranking time in attempting to start your vehicle. |
| Engine Start Pending<br>Please Wait | The starter is attempting to start your vehicle.                                |
| Pending Start Cancelled             | The system has cancelled the pending start.                                     |

## Tire Pressure Monitoring System

| Message                        | Action  |
|--------------------------------|---|
| LOW Tire Pressure              | One or more tires on your vehicle have low tire pressure. See <b>Tire Pressure Monitoring System</b> (page 321).  |
| Tire Pressure Monitor<br>Fault | The tire pressure monitoring system is malfunctioning. If the warning stays on or continues to come on, contact an authorized dealer. See <b>Tire Pressure Monitoring System</b> (page 321).                                      |
| Tire Pressure Sensor<br>Fault  | A tire pressure sensor is malfunctioning, or your spare tire is in use. If the warning stays on or continues to come on, contact an authorized dealer as soon as possible. See <b>Tire Pressure Monitoring System</b> (page 321). |

# Information Displays

## Terrain Management System

| Message                         | Action  |
|---------------------------------|---|
| Normal Mode Active              | Displays terrain management normal mode is currently active.                          |
| Snow, Gravel, Grass Mode Active | Displays terrain management snow, gravel, grass mode is currently active.             |
| Mud, Rut Mode Active            | Displays terrain management mud, ruts mode is currently active.                       |
| Sand Mode Active                | Displays terrain management sand mode is currently active.                            |
| Terrain Management System Fault | Displays when the terrain management system detects an error.                         |
| Mode Change Not Accepted, Retry | Displayed when terrain management mode cannot be changed at the time of your request. |

## Traction Control

| Message              | Action  |
|----------------------|---|
| Traction Control Off | Displays the status of the traction control system. See <b>Using Traction Control</b> (page 188). |
| Traction Control On  | Displays the status of the traction control system. See <b>Using Traction Control</b> (page 188). |

## Trailer

| Message                   | Action  |
|---------------------------|---|
| Trailer Sway Reduce Speed | Displays when the trailer sway control has detected a trailer sway. See <b>Trailer Sway Control</b> (page 240). |

# Information Displays

## Transmission

| Message                                  | Action   |
|--|--|
| Transmission Malfunction Service Now     | Contact an authorized dealer.  |
| Transmission Overtemperature Stop Safely | The transmission is overheating and needs to cool. Stop in a safe place as soon as possible.                 |
| Transmission Overheating Stop Safely     | The transmission is overheating and needs to cool. Stop in a safe place as soon as possible.                 |
| Transmission Service Required            | Contact an authorized dealer.  |
| Transmission Too Hot Press Brake         | The transmission is getting hot. Stop to let it cool.  |
| Transmission Limited Function See Manual | The transmission has overheated and has limited functionality. See <b>Automatic Transmission</b> (page 177). |
| Transmission Warming Up Please Wait      | The transmission is too cold. Wait for it to warm up before you drive.                                       |
| Transmission Not in Park                 | A reminder to shift into park.   |
| Press Brake Pedal                        | A request for you to apply the brake as needed by the transmission.  |
| Transmission Adjusted                    | The transmission has adjusted the shift strategy.  |
| Transmission Adapt-Mode                  | The transmission is adjusting the shift strategy.  |
| Transmission Indicat-Mode Lockup On      | The transmission is locked and unable to select gears.   |
| Transmission Indicat-Mode Lockup Off     | The transmission is unlocked and free to select gears.   |

# Climate Control

## MANUAL CLIMATE CONTROL

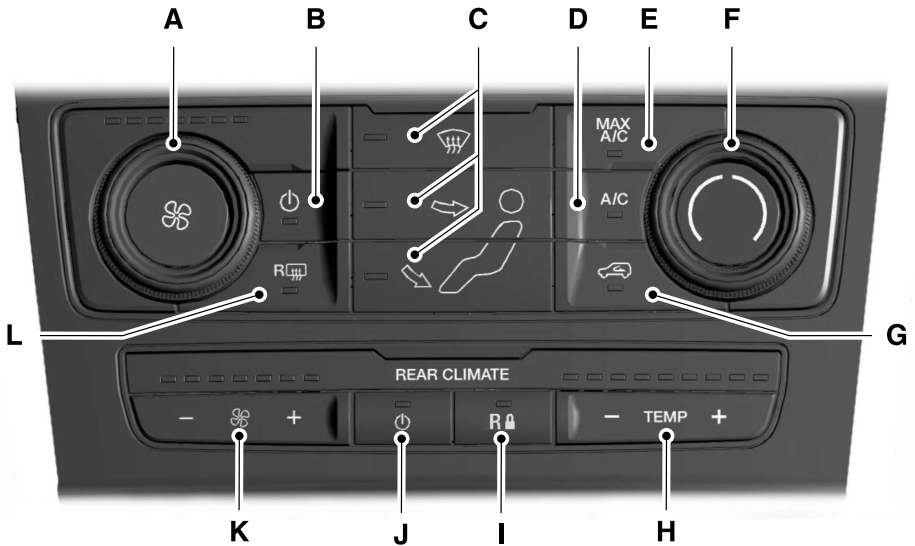

E193398

- A **Fan speed control:** Adjust the volume of air circulated in the vehicle.
- B **Power:** Press to switch the system on and off. When the system is off, it prevents outside air from entering the vehicle.
- C **Air distribution control:** Press to turn airflow from the windshield, instrument panel, or footwell vents on or off. You can distribute air through any combination of these vents.  
**Note:** At least one of these buttons illuminates when the system is on.
- D **A/C:** Press to switch the air conditioning on or off. Air conditioning cools your vehicle using outside air. To improve the time to reach a comfortable temperature in hot weather, drive with the windows open until you feel cold air through the air vents.
- E **MAX A/C:** Adjust for maximum cooling. Recirculated air flows through the instrument panel vents, air conditioning automatically turns on, and fan automatically adjusts to the highest speed.

# Climate Control

- F **Temperature control:** Controls the temperature of the air circulated in your vehicle.
- G **Recirculated air:** Press to switch between outside air and recirculated air. The air currently in the passenger compartment recirculates. This can reduce the time needed to cool the interior and reduce unwanted odors from entering your vehicle.
- H **Rear passenger temperature control:** Adjust the temperature to the rear of the passenger compartment.
- I **Rear climate control lock:** When illuminated, you can only operate the rear passenger settings through the front controls.
- J **Rear passenger power:** Press to switch the rear system on and off.
- K **Rear fan speed control:** Adjust the volume of air circulated to the rear of the passenger compartment.
- L **Heated rear window:** Press to switch the heated rear window on and off.

## AUTOMATIC CLIMATE CONTROL - VEHICLES WITH: PREMIUM AM/FM/CD

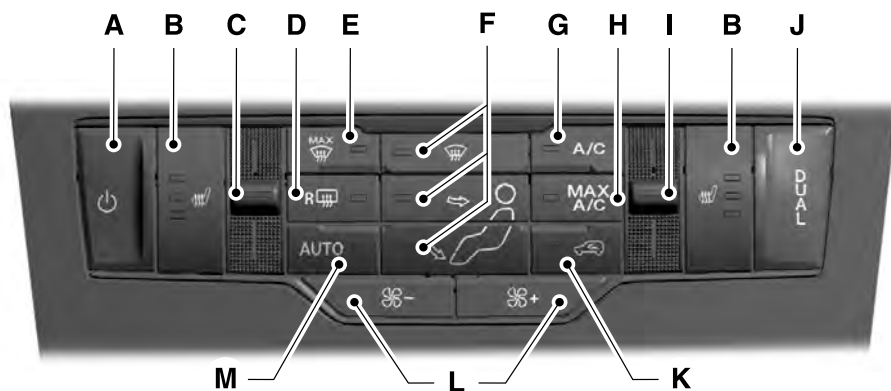

E193399

- A **Power:** Press to switch the system on and off. When the system is off, it prevents outside air from entering the vehicle.
- B **Heated seats:** Press to switch the heated seats on and off.

# Climate Control

---

- C Driver temperature control:** Adjust the temperature setting on the driver side.
- D Heated rear window:** Press to switch the heated rear window on and off.
- E MAX Defrost:** Press to switch on defrost. Outside air flows through the windshield vents, air conditioning automatically turns on, and fan automatically adjusts to the highest speed. You can also use this setting to defrost and clear the windshield of a thin covering of ice. The heated front or rear window also automatically turn on when you select maximum defrost.
- Note:** To prevent window fogging, you cannot select recirculated air when maximum defrost is on.
- F Air distribution control:** Press to switch airflow from the windshield, instrument panel, or footwell vents on or off. You can distribute air through any combination of these vents.
- G A/C:** Press to switch the air conditioning on or off. Air conditioning cools your vehicle using outside air. To improve the time to reach a comfortable temperature in hot weather, drive with the windows open until you feel cold air through the air vents.
- Note:** In certain conditions (for example, maximum defrost), the air conditioning may continue to operate even though the air conditioning is switched off.
- H MAX A/C:** Press for maximum cooling. Recirculated air flows through the instrument panel vents, air conditioning automatically turns on and the fan automatically adjusts to the highest speed.
- I Passenger temperature control:** Adjust the temperature setting on the passenger side.
- J DUAL:** Press to switch on control for the passenger side of the vehicle.
- K Recirculated air:** Press to switch between outside air and recirculated air. The air currently in the passenger compartment recirculates. This can reduce the time needed to cool the interior and reduce unwanted odors from entering your vehicle.
- Note:** Recirculated air may also turn on and off automatically in instrument panel or instrument panel and floor airflow modes during hot weather to improve cooling efficiency.
- L Fan speed control:** Adjust the volume of air circulated in the vehicle.
- M AUTO:** Press to switch on automatic operation. Adjust to select the desired temperature. Fan speed, air distribution, air conditioning operation, and outside or recirculated air are automatically adjusted to heat or cool the vehicle to maintain the desired temperature. You can also switch off dual zone mode by pressing and holding for more than two seconds.

# Climate Control

## AUTOMATIC CLIMATE CONTROL - VEHICLES WITH: SONY AUDIO SYSTEM

**Note:** You can switch temperature units between Fahrenheit and Celsius.



E193400

- A **A/C:** Press to switch the air conditioning on or off. Air conditioning cools your vehicle using outside air. To improve the time to reach a comfortable temperature in hot weather, drive with the windows open until you feel cold air through the air vents.  
**Note:** In certain conditions (for example, maximum defrost), the air conditioning may continue to operate even though the air conditioning is switched off.
- B **MAX A/C:** Press for maximum cooling. Recirculated air flows through the instrument panel vents, air conditioning automatically turns on, and the fan automatically adjusts to the highest speed.
- C **Recirculated air:** Press to switch between outside air and recirculated air. The air currently in the passenger compartment recirculates. This can reduce the time needed to cool the interior and reduce unwanted odors from entering your vehicle.



# Climate Control

---

**Note:** Recirculated air may also turn on and off automatically in instrument panel or instrument panel and floor airflow modes during hot weather to improve cooling efficiency.

- D **DUAL:** Press to switch on control for the passenger side of the vehicle.
- E **Heated seats:** Press to switch the heated seats on and off.
- F **Passenger temperature control:** Adjust the temperature setting on the passenger side.
- G **Climate controlled seats:** Press to switch the climate controlled seats on and off.
- H **Fan speed control:** Adjust the volume of air circulated in the vehicle.
- I **Power:** Press to switch the system on and off. When the system is off, it prevents outside air from entering the vehicle.
- J **Driver temperature control:** Adjust the temperature setting on the driver side. This control also adjusts the passenger side temperature when you switch off dual zone mode.
- K **Heated rear window:** Press to switch the heated rear window on and off.
- L **Defrost:** Select to distribute air through the windshield air vents. Air distribution to the instrument panel and footwell vents turns off. You can also use this setting to defrost and clear the windshield of a thin covering of ice.
- M **MAX Defrost:** Press to switch on defrost. Outside air flows through the windshield vents, air conditioning automatically turns on, and fan automatically adjusts to the highest speed. You can also use this setting to defrost and clear the windshield of a thin covering of ice. The heated front or rear window also automatically turn on when you select maximum defrost.  
**Note:** To prevent window fogging, you cannot select recirculated air when maximum defrost is on.
- N **AUTO:** Press to switch on automatic operation. Adjust to select the desired temperature. Fan speed, air distribution, air conditioning operation, and outside or recirculated air are automatically adjusted to heat or cool the vehicle to maintain the desired temperature. You can also turn off dual zone mode by pressing and holding for greater than two seconds.

# Climate Control

## HINTS ON CONTROLLING THE INTERIOR CLIMATE

### General Hints

#### WARNING



Prolonged use of recirculated air may cause the windows to fog up. If the windows fog up, follow the settings for demisting the windshield.

**Note:** You may feel a small amount of air from the footwell air vents regardless of the air distribution setting.

**Note:** To reduce humidity build-up inside your vehicle, do not drive with the system switched off or with recirculated air always switched on.

**Note:** Do not place objects under the front seats as this may interfere with the airflow to the rear seats.

**Note:** Remove any snow, ice or leaves from the air intake area at the base of the windshield.

**Note:** To improve the time to reach a comfortable temperature in hot weather, drive with the windows open until you feel cold air through the air vents.

### Heating the Interior Quickly

|   | Vehicle with manual climate control                               | Vehicle with automatic climate control                 |
|---|---|--|
| 1 | Adjust the fan speed to a high speed setting.                     | Press the <b>AUTO</b> button.                          |
| 2 | Adjust the temperature control to the full heat setting.          | Adjust the temperature control to the desired setting. |
| 3 | Select the footwell air vents using the air distribution buttons. |  |

### Manual Climate Control

**Note:** To reduce fogging of the windshield during humid weather, adjust the air distribution control to the windshield air vents position.

### Automatic Climate Control

**Note:** Adjusting the settings when your vehicle interior is extremely hot or cold is not necessary. The system automatically adjusts to heat or cool the interior to your selected temperature as quickly as possible. For the system to function efficiently, the instrument panel and side air vents should be fully open.

**Note:** If you select **AUTO** during cold outside temperatures, the system directs airflow to the windshield and side window vents. In addition, the fan may run at a slower speed until the engine warms up.

**Note:** If you select **AUTO** during hot outside temperatures, or when the inside of the vehicle is hot, the system automatically uses recirculated air to maximize interior cooling. When the interior reaches the selected temperature, the system automatically switches to using outside air.

# Climate Control

## Recommended Settings for Heating

|   | Vehicle with manual climate control                                     | Vehicle with automatic climate control  |
|---|---|---|
| 1 | Adjust the fan speed to the center setting.                             | Press the <b>AUTO</b> button.   |
| 2 | Adjust the temperature control to the midway point of the hot settings. | Adjust the temperature control to the desired setting. Use 72°F (22°C) as a starting point, then adjust the setting as necessary. |
| 3 | Select the footwell air vents using the air distribution buttons.       |   |

## Cooling the Interior Quickly

|   | Vehicle with manual climate control  | Vehicle with automatic climate control |
|---|--|--|
| 1 | Adjust the temperature control to the <b>MAX A/C</b> position.                   | Press the <b>MAX A/C</b> button.       |
| 2 | Drive with the windows fully open until you feel cold air through the air vents. |  |

## Recommended Settings for Cooling

|   | Vehicle with manual climate control                                       | Vehicle with automatic climate control  |
|---|---|---|
| 1 | Adjust the fan speed to the center setting.                               | Press the <b>AUTO</b> button.   |
| 2 | Adjust the temperature control to the midway point of the cold settings.  | Adjust the temperature control to the desired setting. Use 72°F (22°C) as a starting point, then adjust the setting as necessary. |
| 3 | Select the instrument panel air vents using the air distribution buttons. |   |

# Climate Control

## Side Window Defogging in Cold Weather

|   | Vehicle with manual climate control                                 | Vehicle with automatic climate control  |
|---|---|---|
| 1 | Select the windshield air vents using the air distribution buttons. | Press the defrost button.   |
| 2 | Press the <b>A/C</b> button if the indicator is off.                | Adjust the temperature control to the desired setting. Use 72°F (22°C) as a starting point, then adjust the setting as necessary. |
| 3 | Adjust the temperature control to the desired setting.              |   |
| 4 | Adjust the fan speed to a high speed setting.                       |   |

## REAR PASSENGER CLIMATE CONTROLS

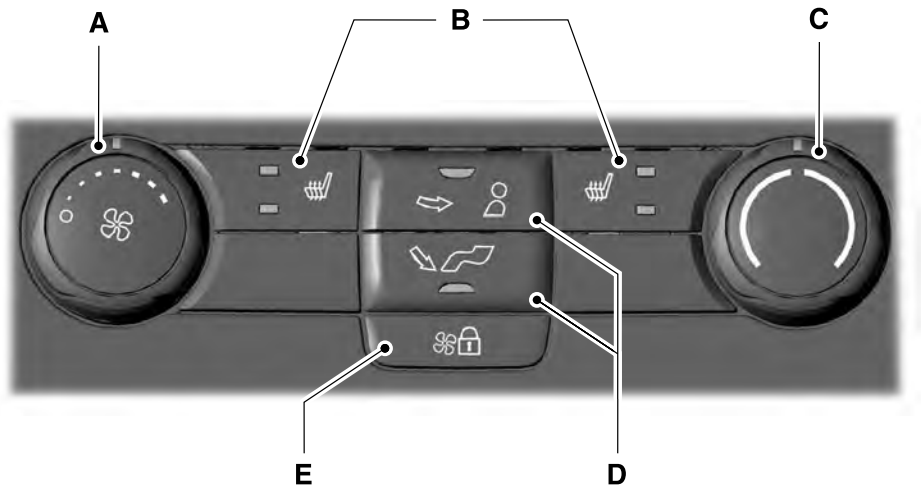

E188689

# Climate Control

- A **Fan speed control:** Adjust the volume of air circulated in the vehicle.
- B **Heated seats (if equipped):** Press the button to switch the heated seats on and off. See **Heated Seats** (page 151).
- C **Temperature control:** Control the temperature of the air circulated in your vehicle.
- D **Air distribution control:** Adjust the control to turn airflow from the instrument panel or footwell vents on or off. You can distribute air through any combination of these vents.
- E **Fan speed control lock:** When illuminated, you can only operate the rear passenger settings through the front controls.

## HEATED WINDOWS AND MIRRORS (If Equipped)

### Heated Rear Window

**Note:** Make sure the engine is running before operating the heated windows.



Press the button to clear the heated rear window of thin ice and fog. The heated rear window will automatically turn off after a short period of time. Start the engine before you switch the heated rear window on.

**Note:** Do not use razor blades or other sharp objects to clean or remove decals from the inside of the heated rear window. The vehicle warranty does not cover damage caused to the heated rear window grid lines.

### Heated Exterior Mirror (If Equipped)

When you switch the heated rear window on, the heated exterior mirrors will automatically turn on.

**Note:** Do not remove ice from the mirrors with a scraper or adjust the mirror glass when it is frozen in place.

**Note:** Do not clean the mirror housing or glass with harsh abrasives, fuel or other petroleum-based cleaning products.

## CABIN AIR FILTER

Your vehicle is equipped with a cabin air filter, which gives you and your passengers the following benefits:

- It improves your driving comfort by reducing particle concentration.
- It improves the interior compartment cleanliness.
- It protects the climate control components from particle deposits.

You can locate the cabin air filter behind the glove box.

**Note:** Make sure you have a cabin air filter installed at all times. This prevents foreign objects from entering the system. Running the system without a filter in place could result in degradation or damage to the system.

Replace the filter at regular intervals. See **Scheduled Maintenance** (page 483).

For additional cabin air filter information, or to replace the filter, see an authorized dealer.

# Climate Control

---

## REMOTE START (If Equipped)

The remote start feature allows you to pre-condition the interior of your vehicle. The climate control system works to achieve comfort according to your previous settings.

**Note:** *You cannot adjust the system during remote start operation.*

Turn the ignition on to return the system to its previous settings. You can now make adjustments normally, but you need to turn certain vehicle-dependent features back on, such as:

- Heated seats.
- Cooled seats.
- Heated steering wheel.
- Heated mirrors.
- Heated rear window.

You can adjust the default remote start settings using the information display controls. See **Information Displays** (page 99).

## Automatic Settings

In hot weather, the system is set to 72°F (22°C). The cooled seats are set to high (if available, and selected to AUTO in the information display).

In moderate weather, the system either heats or cools (based on previous settings). The rear defroster, heated mirrors and heated seats do not automatically turn on.

In cold weather, the system is set to 72°F (22°C). The heated seats are set to high (if available, and selected to AUTO in the information display). The rear defroster and heated mirrors automatically turn on.

# Seats

## SITTING IN THE CORRECT POSITION

### WARNINGS



Sitting improperly, out of position or with the seatback reclined too far can take weight off the seat cushion and affect the decision of the passenger sensing system, resulting in serious injury or death in the event of a crash. Always sit upright against your seat back, with your feet on the floor.



Do not recline the seatback as this can cause the occupant to slide under the safety belt, resulting in serious injury in the event of a crash.



Do not place objects higher than the seatback to reduce the risk of serious injury in the event of a crash or during heavy braking.

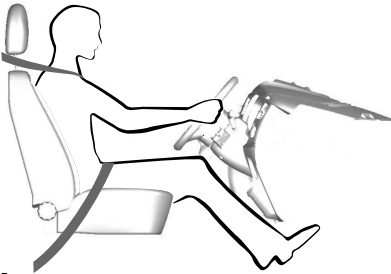

E68595

When you use them properly, the seat, head restraint, safety belt and airbags will provide optimum protection in the event of a crash.

We recommend that you follow these guidelines:

- Sit in an upright position with the base of your spine as far back as possible.
- Do not recline the seatback more than 30 degrees.
- Adjust the head restraint so that the top of it is level with the top of your head and as far forward as possible. Make sure that you remain comfortable.
- Keep sufficient distance between yourself and the steering wheel. We recommend a minimum of 10 in (25 cm) between your breastbone and the airbag cover.
- Hold the steering wheel with your arms slightly bent.
- Bend your legs slightly so that you can press the pedals fully.
- Position the shoulder strap of the safety belt over the center of your shoulder and position the lap strap tightly across your hips.

Make sure that your driving position is comfortable and that you can maintain full control of your vehicle.

## HEAD RESTRAINTS

### WARNINGS



Fully adjust the head restraint before you sit in or operate your vehicle. This will help minimize the risk of neck injury in the event of a crash. Do not adjust the head restraint when your vehicle is moving.



The head restraint is a safety device. Whenever possible it should be installed and properly adjusted when the seat is occupied.

# Seats

## WARNINGS



Install the head restraint properly to help minimize the risk of neck injury in the event of a crash.

**Note:** Adjust the seatback to an upright driving position before adjusting the head restraint. Adjust the head restraint so that the top of it is level with the top of your head and as far forward as possible. Make sure that you remain comfortable. If you are extremely tall, adjust the head restraint to its highest position.

### Front seat head restraints

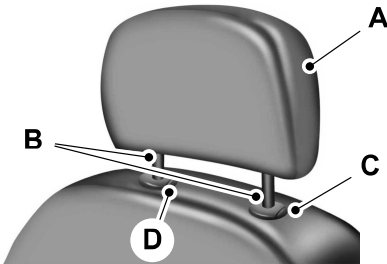

E138642

### Second-row center seat head restraint (If equipped)

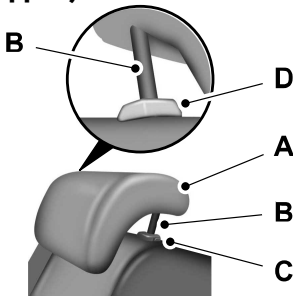

E138645

The head restraints consist of:

- A An energy absorbing head restraint.
- B Two steel stems.
- C Guide sleeve adjust and release button.
- D Guide sleeve unlock and remove button.

## Adjusting the Head Restraint

### Raising the Head Restraint

Pull the head restraint up.

### Lowering the Head Restraint

1. Press and hold button C.
2. Push the head restraint down.

### Removing the Head Restraint

1. Pull the head restraint up until it reaches its highest position.
2. Press and hold buttons C and D.
3. Pull the head restraint up.



# Seats

## Installing the Head Restraint

Align the steel stems into the guide sleeves and push the head restraint down until it locks.

## Second-row outboard seat head restraints

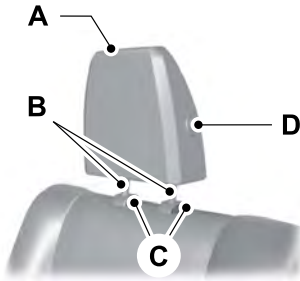

The head restraints consist of:

- A An energy absorbing head restraint.
- B Two steel stems.
- C Guide sleeve unlock and remove button.
- D Fold button.

## Folding the Head Restraint

1. Press and hold button D.
2. Pull it back up to reset.

## Removing the Head Restraint

1. Fold the head restraint.
2. Press and hold both C buttons.
3. Pull the head restraint up.

## Installing the Head Restraint

Align the steel stems into the guide sleeves and push the head restraint down until it locks.

## Third-row head restraints

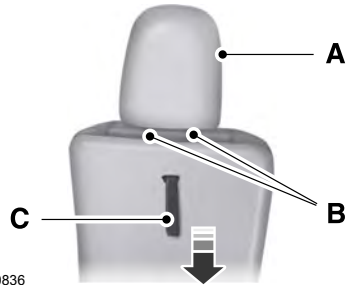

The head restraints consist of:

- A An energy absorbing head restraint.
- B Two steel stems.
- C Fold strap.

## Folding the Head Restraint

Pull the fold strap (C). Pull it back up to reset.

**Note:** Press the stow or fold button on the power folding seats to automatically fold the head restraint.

## Tilting Head Restraints (If Equipped)

The front head restraints tilt for extra comfort. To tilt the head restraint, do the following:

# Seats



E144727

1. Adjust the seatback to an upright driving or riding position.
2. Pivot the head restraint forward toward your head to the desired position.

After the head restraint reaches the forward-most tilt position, pivoting it forward again will then release it to the rearward, un-tilted position.

## MANUAL SEATS (If Equipped)

### Moving the Seat Backward and Forward

#### WARNINGS



Do not adjust the driver seat or seatback when your vehicle is moving.



Rock the seat backward and forward after releasing the lever to make sure that it is fully engaged.



E190838

### Recline Adjustment

#### WARNING



Always drive and ride with your seatback upright and the lap belt snug and low across the hips.

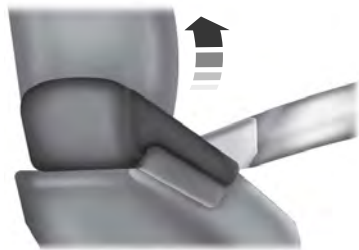

E190837

# Seats

## Lumbar Adjustment (If Equipped)



E190839

## POWER SEATS

### WARNINGS



Do not adjust the driver seat or seatback when your vehicle is moving. Adjusting your seatback while the vehicle is in motion may cause loss of control of the vehicle.



Do not place cargo or any objects behind the seatback before returning it to the original position.



E176038

# Seats

## Power Lumbar (If Equipped)



E176039

**Note:** The engine must be running or the vehicle must be in accessory mode to activate the seats.

**Note:** Allow a few seconds for any selection to activate. The seatback and cushion massage cannot function at the same time.

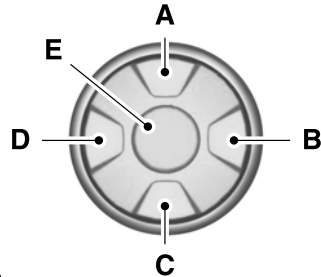

E156301

## Multi-Contour Front Seats With Active Motion (If Equipped)

**Note:** The massage system will turn off after 20 minutes.

|   | Massage mode                         | Lumbar and bolster mode |
|---|--------------------------------------|-------------------------|
| A | Back massage intensity adjustment    | Upper lumbar            |
| B | Massage intensity decrease and off*  | Lumbar decrease         |
| C | Cushion massage intensity adjustment | Lower lumbar**          |
| D | Massage intensity increase           | Lumbar increase         |
| E | On and off                           | -                       |

\*The massage feature will default to an alternating massage mode with back massage intensity adjustment. The lumbar and bolster feature will default to the middle lumbar mode.

\*\*Press C a second time to adjust the back bolster. Press C a third time to adjust the cushion bolster.

You can also adjust this feature through the touchscreen. When switched on, the system displays directions for you to adjust the lumbar settings in your seat or to set the massage function. To access and make adjustments to the lumbar setting:

1. Press the Menu Settings icon > Vehicle > Multi-contour Seat.
2. Choose the desired seat to adjust.
3. Press the + or - to adjust the lumbar intensity.

# Seats

To access and make adjustments to the massage setting:

1. Press the Menu Settings icon > Vehicle > Multi-contour Seat.
2. Choose the desired seat to adjust.
3. Press Off, Lo or Hi.

## MEMORY FUNCTION (If Equipped)

### WARNINGS



Before activating the memory seat, make sure that the area immediately surrounding the seat is clear of obstructions and that all occupants are clear of moving parts.



Do not use the memory function when your vehicle is moving.

This feature automatically recalls the position of the following:

- Driver seat.
- Power mirrors.
- Optional power adjustable foot pedals.
- Optional steering column.

The memory control is on the driver door.



E142554

## Saving a PreSet Position

1. Switch the ignition on.
2. Adjust the memory features to your desired position.
3. Press and hold the desired preset button until you hear a single tone.

You can save up to three preset memory positions. You can save a memory preset at any time.

## Recalling a PreSet Position

Press and release the preset button associated with your desired driving position. The memory features move to the position stored for that preset.

**Note:** You can only recall a preset memory position when the ignition is off, or when the transmission is in park (P) or neutral (N) if the ignition is on.

You can also recall a preset memory position by:

- Pressing the unlock button on your intelligent access key fob if it is linked to a preset position.
- Unlocking the intelligent driver door handle if a linked key fob is present.
- Entering a personal entry code on the Securicode keypad. See **Locks** (page 60).

**Note:** Using a linked key fob to recall your memory position when the ignition is off moves the seat to the Easy Entry position.

**Note:** Pressing any active memory feature adjustment control (or any memory button) during a memory recall cancels the operation.

# Seats

## Linking a PreSet Position to your Remote Control or Intelligent Access Key Fob

Your vehicle can save the preset memory positions for up to three remote controls or intelligent access (IA) keys.

1. With the ignition on, move the memory positions to the desired positions.
2. Press and hold the desired preset button for about five seconds. A tone sounds after about two seconds. Continue holding until you hear a second tone.
3. Within three seconds, press the lock button on the remote control you are linking.

To unlink a remote control, follow the same procedure – except in step 3, press the unlock button on the remote control.

**Note:** *If more than one linked remote control or intelligent access key is in range, the memory function moves to the settings of the first key to recall a memory position.*

## Easy Entry and Exit Feature

If you enable the easy entry and exit feature, it automatically moves the driver seat position rearward up to two inches (five centimeters) when you switch the ignition off.

The driver seat returns to the previous position when you switch the ignition on.



You can enable or disable this feature in the information display. See **Information Displays** (page 99).

## REAR SEATS

### Adjusting the Rear Seats

#### Second Row Seats

##### WARNINGS

-  Always drive and ride with your seatback upright and the lap belt snug and low across the hips.
-  Reclining the seatback can cause an occupant to slide under the seat's safety belt, resulting in severe personal injuries in the event of a crash.

#### Recline Adjustment



E190840

Lift the handle to adjust the seatback rearward or forward. The seatback can also fold forward until it is flat.

#### Fold flat seatback



E213288

# Seats

Lift the handle and fold the seatback forward until it is flat.

**Note:** For the bench seats, make sure the center safety belt is unbuckled before folding the seatback.

## Moving the Seats Backward and Forward (If equipped)



E190838

## Third Row Seats (Manual Seats)

### WARNINGS



Before returning the seatback to its original position, make sure that cargo or any objects are not trapped behind the seatback. After returning the seatback to its original position, pull on the seatback to make sure that it has fully latched. An unlatched seat may become dangerous in the event of a sudden stop or crash.



Do not adjust or release the seat floor latch while vehicle is in motion. Do not operate the vehicle with seats in the tumbled position. Always latch the vehicle seat to the floor, whether the seat is occupied or empty. If not latched or if the seat is tumbled, the seat may cause injury during a sudden stop.

**Note:** Remove items from the second-row seat. Make sure that no bulky objects such as purses or briefcases are on the floor in front of the second-row seats before tumbling them.

**Note:** For second-row bench seats, make sure the center safety belt is unbuckled before folding the seatback.

**Note:** You may have to move the front-row seat forward to allow the second-row seat to be fully tumbled.

**Note:** You may have to lower the center head restraint. See **Head Restraints** (page 137).

Fold and tumble the second-row seat to access the third row:

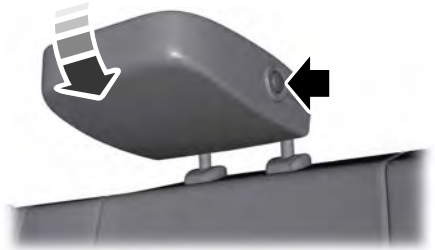

E193964

1. Fold the outboard head restraint.



E213288

2. Lift the handle located on the side of the seat to fold the seatback flat.

# Seats



E190844

3. Lift the handle all the way up until the seat releases from the floor. Rotate the seat forward to allow access to the third row.



E190845

4. To return the seatback to the floor from the tumbled position, rotate the seat down until you hear it latching to the floor.



E190846

5. Lift the seatback toward the rear of the vehicle, and rotate the seatback until you hear a click, locking it in the upright position. **Note:** The seatback will not raise if the rear latch hooks are not properly engaged to the floor striker. If the seatback does not raise, then repeat Step 4.
6. Pull the head restraint back up to its normal adjusted position.

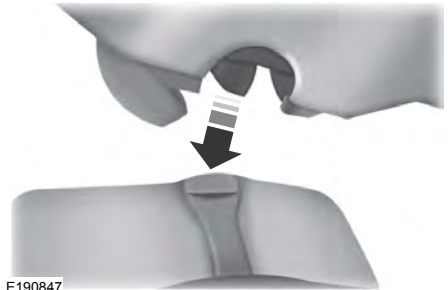

E190847

Make sure that the rear latch hooks are properly engaged with the floor striker.

**Note:** Make sure that the seat and seatback are latched securely in position. Keep floor area free of objects that would prevent proper seat engagement.

## Third Row Seat Access (Power Fold and Tumble Seat-If equipped)

### WARNING



Make sure that the seat is unoccupied when folding it down. Folding the seat while occupied could result in occupant injury or damage to the seat.



# Seats



E190848

The control is located at the back of the rear door opening. Press and hold it to fold the seatback down and tumble the seat forward for access to the third row.

## Third Row Seat Exit (Manual Seat, Power Fold and Tumble Seat)

### WARNINGS



Before returning the seatback to its original position, make sure that cargo or any objects are not trapped behind the seatback. After returning the seatback to its original position, pull on the seatback to make sure that it has fully latched. An unlatched seat may become dangerous in the event of a sudden stop or crash.



Do not adjust or release the seat floor latch while vehicle is in motion. Do not operate the vehicle with seats in the tumbled position. Always latch the vehicle seat to the floor, whether the seat is occupied or empty. If not latched or if the seat is tumbled, the seat may cause injury during a sudden stop.

**Note:** You may have to lower the center head restraint. See **Head Restraints** (page 137).

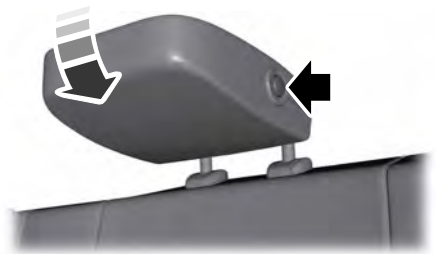

E193964

1. Fold the outboard head restraint.



E190849

2. Pull on the strap located on the back of the second row seat. This will fold the seatback forward. Pull the strap a second time to tumble the seat forward, allowing easy exit from the third row seat.



E190850

# Seats

3. To return the seatback to the floor from the tumbled position, rotate the seat down until you hear it latching to the floor.



E190846

4. Lift the seatback toward the rear of the vehicle, and rotate the seatback until you hear a click, locking it in the upright position. **Note:** The seatback will not raise if the rear latch hooks are not properly engaged to the floor striker. If the seatback does not raise, then repeat Step 3.
5. Pull the head restraint back up to its normal adjusted position.

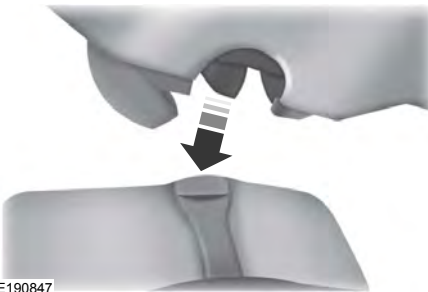

E190847

Make sure that the rear latch hooks are properly engaged with the floor striker.

**Note:** Make sure that the seat and seatback are latched securely in position. Keep floor area free of objects that would prevent proper seat engagement.

## Folding the Third Row Manual Seat

1. Remove all objects from the seat and stowage tub.



E193843

2. Fold the outboard head restraint by pulling the head restraint release strap.



E190854

3. From the rear of the vehicle, fold the seatback by pulling and holding the red strap while pushing the seatback forward. Release the strap once the seatback starts rotating forward.

# Seats



E190923

4. Release the cushion latches by pulling the short black strap while pulling on the strap located at the top of the seatback to tumble the seat all the way into the tub in the floor.

**Note:** Do not use the seat anchors as cargo tie downs.



E190924

**Note:** Do not use the third row seat back as a load floor when the seatback is folded.

**Note:** Make sure that the area under the seat is free of objects before stowing it.

## Unfolding the Third Row Manual Seat

### WARNINGS



Make sure seat is latched to vehicle floor by pushing and pulling on the seat. If not latched, the seat may cause injury during a sudden stop.

### WARNINGS



Before returning the seatback to its original position, make sure that cargo or any objects are not trapped behind the seatback. After returning the seatback to its original position, pull on the seatback to make sure that it has fully latched. An unlatched seat may become dangerous in the event of a sudden stop or crash.



Do not drive the vehicle when the third-row seat is rotated backwards. During a sudden stop, the safety belts are not functional in this position and the third-row seat can rapidly tip back to the forward position, all of which may result in serious injury.



E190927

**Note:** Make sure that there are no objects such as books, purses or briefcases on the load floor before unstowing the seat. Failure to remove all objects from the top of the load floor prior to unstowing it may cause damage to the seat.

**Note:** Make sure the area under the load floor is free of objects before unstowing it.

# Seats



E190925

1. Unlatch and lift the seat out of the tub in the floor by squeezing and pulling up on the handle. Once the seat is at a vertical position, push the seat over, letting it fall onto the latches.



E190926

2. To return the seatback to the upright position, pull the red strap. Then while holding the red strap, pull the long strap located on the seatback to raise the seatback.
3. Pull the head restraints up to their normal positions.

## PowerFold™ Third Row Seats (If equipped)

The third row power seat buttons are located behind the third row seats on the left-hand quarter trim panel.

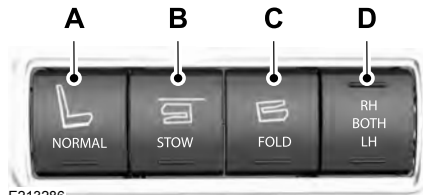

E213286

- A NORMAL: Press to return the seat to the normal seating position.
- B STOW: Press to stow the seat into the tub floor.
- C FOLD: Press to fold down the seatback.
- D RH / BOTH / LH: Press to select the normal, stow and fold modes to activate the right-hand seat, the left-hand seat or both.

**Note:** The third row seat includes obstacle detection that allows the seat to stop and reverse direction if it hits an obstacle so that the obstacle can be removed.

**Note:** Pressing a different button while the power seat feature is already being performed may cause the first selected seat movement to be cancelled. Allow the first seat movement to be completed before pressing a button for another function.

**Note:** Make sure that there are no objects such as books, purses or briefcases on the load floor before unstowing the seat. Failure to remove all objects from the top of the load floor prior to unstowing it may cause damage to the seat.

**Note:** In order to allow the seat to complete the stowed position, do not place objects under the seat before stowing. Remove all objects from the seat and stowage tub.

# Seats

**Note:** In the unlikely event that the third row power seat stops prematurely or travels to an unexpected position, press the **FOLD button (C)** to reset the seat and return it to a normal position.

These seats feature a power one-touch operation that allows you fold and stow the seats.

- The power fold seats work only when the transmission is in park (P) and the liftgate is open.
- If the ignition is off and the feature is still running, the battery saver will turn it off after 10 minutes. Press unlock on the remote entry key transmitter to reactivate the power seats or unlock it with the keyless entry keypad. See **Remote Control** (page 49).

## HEATED SEATS (If Equipped)

### Front Seats

#### WARNING



People who are unable to feel pain to their skin because of advanced age, chronic illness, diabetes, spinal cord injury, medication, alcohol use, exhaustion or other physical conditions, must exercise care when using the heated seat. The heated seat may cause burns even at low temperatures, especially if used for long periods of time. Do not place anything on the seat that insulates against heat, such as a blanket or cushion. This may cause the heated seat to overheat. Do not puncture the seat with pins, needles or other pointed objects. This may damage the heating element which may cause the heated seat to overheat. An overheated seat may cause serious personal injury.

Do not do the following:

- Place heavy objects on the seat.
- Operate the heated seat if water or any other liquid spills on the seat. Allow the seat to dry thoroughly.

**Note:** You must switch the ignition on to use this feature.



E146322

Press the heated seat symbol to cycle through the various heat settings and off. More indicator lights indicate warmer settings.

### Second Row Heated Seats (If Equipped)

#### WARNING



Persons who are unable to feel pain to the skin because of advanced age, chronic illness, diabetes, spinal cord injury, medication, alcohol use, exhaustion, or other physical conditions, must exercise care when using the seat heater. The seat heater may cause burns even at low temperatures, especially if used for long periods of time. Do not place anything on the seat that insulates against heat, such as a blanket or cushion, because this may cause the seat heater to overheat. Do not puncture the seat with pins, needles, or other pointed objects because this may damage the heating element which may cause the seat heater to overheat. An overheated seat may cause serious personal injury.

# Seats

Do not do the following:

- Place heavy objects on the seat.
- Operate the seat heater if water or any other liquid spills on the seat. Allow the seat to dry thoroughly.

**Note:** You must switch the ignition on to use this feature.



E146322

Press the heated seat symbol to cycle through the various heat settings and off. More indicator lights indicate warmer settings.

## CLIMATE CONTROLLED SEATS

(If Equipped)

### Heated Seats

#### WARNING



People who are unable to feel pain to their skin because of advanced age, chronic illness, diabetes, spinal cord injury, medication, alcohol use, exhaustion or other physical conditions, must exercise care when using the heated seat. The heated seat may cause burns even at low temperatures, especially if used for long periods of time. Do not place anything on the seat that insulates against heat, such as a blanket or cushion. This may cause the heated seat to overheat. Do not puncture the seat with pins, needles or other pointed objects. This may damage the heating element which may cause the heated seat to overheat. An overheated seat may cause serious personal injury.

Do not do the following:

- Place heavy objects on the seat.
- Operate the heated seat if water or any other liquid spills on the seat. Allow the seat to dry thoroughly.

**Note:** You must switch the ignition on to use this feature.



E146322

Press the heated seat symbol to cycle through the various heat settings and off. More indicator lights indicate warmer settings.

### Cooled Seats

**Note:** You must switch the ignition on to use this feature.



E146309

Press the cooled seat symbol to cycle through the various cool settings and off. More indicator lights indicate cooler settings.

If the engine falls below 350 RPM while the cooled seats are on, the feature will turn itself off. You will need to reactivate it.

# Seats

---

## **Climate Controlled Seat Air Filter Replacement**

Your vehicle is equipped with lifetime air filters that are integrated with the seats. Regular maintenance or replacement is not required.

# Universal Garage Door Opener (If Equipped)

## HomeLink Wireless Control System

### WARNINGS



Make sure that the garage door and security device are free from obstruction when you are programming. Do not program the system with the vehicle in the garage.



Do not use the system with any garage door opener that does not have the safety stop and reverse feature as required by U.S. Federal Safety Standards (this includes any garage door opener manufactured before April 1, 1982). A garage door opener which cannot detect an object, signaling the door to stop and reverse, does not meet current federal safety standards. Using a garage door opener without these features increases the risk of serious injury or death.

**Note:** Make sure you keep the original remote control transmitter for use in other vehicles as well as for future system programming.

**Note:** We recommend that upon the sale or lease termination of your vehicle, you erase the programmed function buttons for security reasons. See **Erasing the Function Button Codes**.

**Note:** You can program a maximum of three devices. To change or replace any of the three devices after it has been initially programmed, you must first erase the current settings. See **Erasing the Function Button Codes**.



E142657

The universal garage door opener replaces the common hand-held garage door opener with a three-button transmitter that is integrated into the driver's sun visor.

The system includes two primary features, a garage door opener and a platform for remote activation of devices within the home. As well as being programmed for garage doors, the system transmitter can be programmed to operate entry gate operators, security systems, entry door locks and home or office lighting.

Additional system information can be found online at [www.homelink.com](http://www.homelink.com), [www.youtube.com/HomeLinkGentex](http://www.youtube.com/HomeLinkGentex) or by calling the toll-free help line on 1-800-355-3515.

### In-Vehicle Programming

This process is to program your hand-held transmitter and your in-vehicle HomeLink button.

**Note:** The programming steps below assume you will be programming HomeLink that was not previously programmed.

**Note:** Put a new battery in the hand-held transmitter. This will ensure quicker training and accurate transmission of the radio-frequency signal.



## Universal Garage Door Opener (If Equipped)

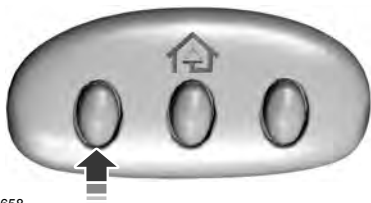

E142658

1. With your vehicle parked outside of the garage, turn your ignition to the **on** position, but do not start your vehicle.
2. Hold your hand-held garage door transmitter 2–6 in (5–14 cm) away from the HomeLink button you want to program.
3. Using both hands, simultaneously, press and hold the desired HomeLink button and the hand-held transmitter button. **DO NOT** release either one until the HomeLink indicator light flashes slowly and then rapidly. When the indicator light flashes rapidly, both buttons may be released. The rapid flashing indicates successful training.

**Note:** You may need to use a different method if you live in Canada or have difficulties programming your gate operator or garage door opener. See **Gate Operator / Canadian Programming**.

4. Press and hold the HomeLink button you programmed for two seconds, then release. You may need to do this twice to activate the door. If your garage door does not operate, watch the HomeLink indicator light.

**If the indicator light stays on, the programming is complete. No further action is needed.**

If the indicator light flashes rapidly for 2 seconds and then turns to a constant light, the HomeLink button is not programmed yet. See **Programming Your Garage Door Opener Motor**.

To program additional buttons, repeat Steps 1 – 4.

For questions or comments, please contact HomeLink at [www.homelink.com](http://www.homelink.com), [www.youtube.com/HomeLinkGentex](http://www.youtube.com/HomeLinkGentex) or 1-800-355-3515.

### Programming Your Garage Door Opener Motor

**Note:** You may need a ladder to reach the unit and you may need to remove the cover or lamp lens on your garage door opener.



E142659

1. Press the learn button on the garage door opener motor and then you have 30 seconds to complete the next two steps.
2. Return to your vehicle.

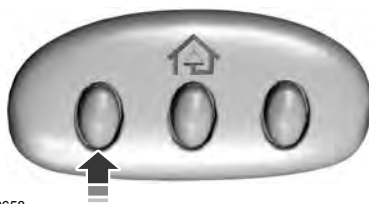

E142658

3. Press and hold the function button you want to program for 2 seconds, then release. Repeat this step. Depending on your brand of garage door opener, you may need to repeat this sequence a third time.

# Universal Garage Door Opener (If Equipped)

## Gate Operator / Canadian Programming

Canadian radio-frequency laws require transmitter signals to “time-out” (or quit) after several seconds of transmission – which may not be long enough for HomeLink to pick up the signal during programming. Similar to this Canadian law, some U.S. gate operators are designed to “time-out” in the same manner.

**Note:** *If programming a garage door opener or gate operator, it is advised to unplug the device during the “cycling” process to prevent possible overheating.*

1. Press and hold the HomeLink button while you press and release, **every two seconds**, your hand-held transmitter until the HomeLink indicator light changes from a slow to a rapidly blinking light.
2. Release both the HomeLink and hand-held transmitter buttons.
3. Continue programming HomeLink. See **In-Vehicle Programming**.

## Erasing the Function Button Codes

**Note:** *You cannot erase individual buttons.*

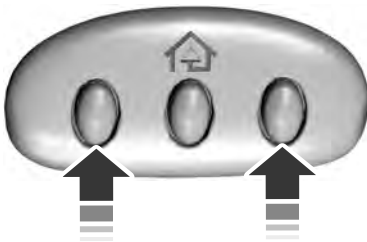

E142660

1. Press and hold the outer two function buttons simultaneously for approximately 20 seconds until the indicator lights above the buttons flash rapidly.
2. When the indicator lights flash, release the buttons. The codes for all buttons are erased.

## Reprogramming a Single Button

To program a device to a previously trained button, follow these steps:

1. Press and hold the desired button. Do NOT release the button.
2. The indicator light will begin to flash after 20 seconds. Without releasing the button, follow Step 1 in the Programming section.

For questions or comments, contact HomeLink at [www.homelink.com](http://www.homelink.com), [www.youtube.com/HomeLinkGentex](http://www.youtube.com/HomeLinkGentex) or 1-800-355-3515.

## Programming to a Genie Intellicode 2 Garage Door Opener

**Note:** *The Genie Intellicode 2 transmitter must already be programmed to operate with the garage door opener.*

**Note:** *To program HomeLink to the transmitter you must first put the transmitter into programming mode.*

## Universal Garage Door Opener (If Equipped)

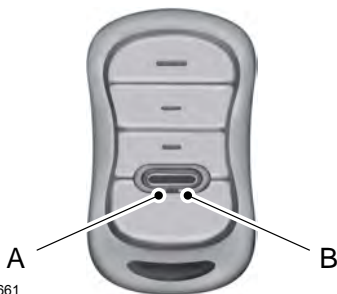

E142661

- A. Red indicator light
- B. Green indicator light

1. Press and hold one of the buttons on the hand-held transmitter for 10 seconds. The indicator light will change from green to red and green.
2. Press the same button twice to confirm the change to programming mode. If done properly the indicator light will appear red.
3. Hold the transmitter within 1–3 inches (2–8 centimeters) of the button on the visor you want to program.
4. Press and hold both the programmed Genie button on the hand-held transmitter and the button you want to program. The indicator light on the visor will flash rapidly when the programming is successful.

**Note:** *The Genie transmitter will transmit for up to 30 seconds. If HomeLink does not program within 30 seconds the Genie transmitter will need to be pressed again. If the Genie transmitter indicator light displays green and red, release the button until the indicator light turns off before pressing the button again.*

Once HomeLink has been programmed successfully, the Genie transmitter must be changed out of program mode. To do this:

1. Press and hold the previously programmed Genie button on the hand-held transmitter for 10 seconds. The indicator light will change from red to red and green.
2. Press the same button twice to confirm the change. If done correctly the indicator light will turn green.

### Programming HomeLink to the Genie Intellicode Garage Door Opener Motor

**Note:** *You may need a ladder to access the garage door opener motor.*

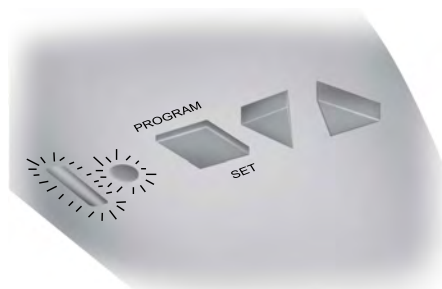

E142662

1. Press and hold the program button on the garage door opener motor until both blue indicator lights turn on.
2. Release the program button. Only the smaller round indicator light should be on.
3. Press and release the program button. The larger purple indicator light will flash.

**Note:** *The next two steps must be completed in 30 seconds.*

4. Press and release the Genie Intellicode 2 hand-held transmitter's previously programmed button. Both indicator lights on the garage door opener motor unit should now flash purple.

## Universal Garage Door Opener (If Equipped)

---

5. Press and hold the previously programmed button on the visor for 2 seconds. Repeat this step up to 3 times until the garage door moves.

Programming is now complete.

### **Clearing a HomeLink Device**

To erase programming from the three HomeLink buttons press and hold the two outer HomeLink buttons until the indicator light begins to flash. The indicator light will begin flashing in 10 to 20 seconds, at which time both buttons should be released. Programming has now been erased, and the indicator light should blink slowly to indicate the device is in train mode when any of the three HomeLink buttons are pressed.

### **FCC and RSS-210 Industry Canada Compliance**

This device complies with Part 15 of the FCC Rules and with RSS-210 of Industry Canada. Operation is subject to the following two conditions: (1) this device may not cause harmful interference, and (2) this device must accept any interference received, including interference that may cause undesired operation.

Changes or modifications to your device not expressly approved by the party responsible for compliance can void the user's authority to operate the equipment.

# Auxiliary Power Points

## 12 Volt DC Power Point

### WARNINGS



Do not plug optional electrical accessories into the cigar lighter socket. Incorrect use of the cigar lighter can cause damage not covered by the vehicle warranty, and can result in fire or serious injury.



Do not use a power point for operating a cigar lighter. Incorrect use of the power points can cause damage not covered by the vehicle warranty, and can result in fire or serious injury.

**Note:** When you switch the ignition on, you can use the socket to power 12 volt appliances with a maximum current rating of 15 amps.

If the power supply does not work after you switch the ignition off, switch the ignition on.

**Note:** Do not hang any accessory from the accessory plug.

**Note:** Do not use the power point over the vehicle capacity of 12 volt DC 180 watts or a fuse may blow.

**Note:** Always keep the power point caps closed when not in use.

Do not insert objects other than an accessory plug into the power point. This will damage the power point and blow the fuse.

Run the vehicle for full capacity use of the power point.

To prevent the battery from running out of charge:

- Do not use the power point longer than necessary when the vehicle is not running.
- Do not leave devices plugged in overnight or when you park your vehicle for extended periods.

## Locations

Power points may be in the following locations:

- On the lower instrument panel.
- Inside the center console.
- On the rear of the center console.
- In the rear cargo area.

## 110 Volt AC Power Point (If Equipped)

### WARNING



Do not keep electrical devices plugged in the power point whenever the device is not in use. Do not use any extension cord with the 110 volt AC power point, since it will defeat the safety protection design. Doing so may cause the power point to overload due to powering multiple devices that can reach beyond the 150 watt load limit and could result in fire or serious injury.

**Note:** The power point will turn off when the ignition is switched off or the battery voltage drops below 11 volts.

Use the power point for powering electric devices that require up to 150 watts. It is on the rear of the center console.

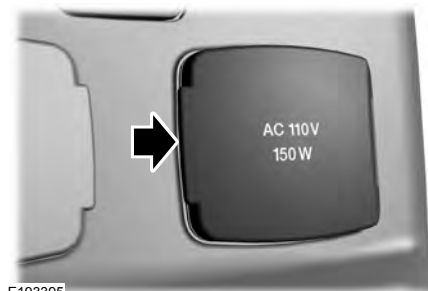

E193395

**Note:** Depending on your vehicle, the power point cover may open to the right or upward.

# Auxiliary Power Points

---

When the indicator light on the power point is:

- On: The power point is working, the ignition is on and a device is plugged in.
- Off: The power point is off, the ignition is off or no device is plugged in.
- Flashing: The power point is in fault mode.

The power outlet temporarily turns off power when in fault mode if the device exceeds the 150 watt limit. Unplug your device and switch the ignition off. Switch the ignition back on, but do not plug your device back in. Let the system cool off and switch the ignition off to reset the fault mode. Switch the ignition back on and make sure the indicator light remains on.

Do not use the power point for certain electric devices, including:

- Cathode-ray, tube-type televisions.
- Motor loads, such as vacuum cleaners, electric saws and other electric power tools or compressor-driven refrigerators.
- Measuring devices, which process precise data, such as medical equipment or measuring equipment.
- Other appliances requiring an extremely stable power supply such as microcomputer-controlled electric blankets or touch-sensor lamps.

# Storage Compartments

## CENTER CONSOLE

Stow items in the cup holder carefully as items may become loose during hard braking, acceleration or crashes, including hot drinks which may spill.

Available console features include:

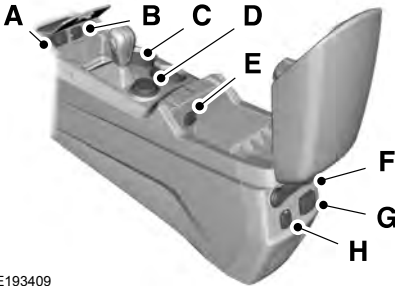

E193409

- A USB, or USB and SD card (if equipped).
- B Power point.
- C Cup holder.
- D Hill descent control (if equipped).
- E 110 volt AC power point or USB port (if equipped).
- F Rear climate controls (if equipped).
- G 110 volt AC power point / 230 volt AC power point (if equipped).
- H USB smart charger (if equipped).

## Rear Seat Armrest



E190042

## OVERHEAD CONSOLE

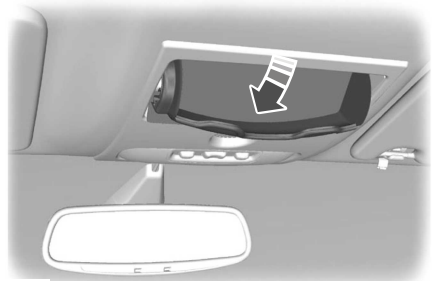

E75193

Press near the rear edge of the door to open it.

# Starting and Stopping the Engine

## GENERAL INFORMATION

### WARNINGS



Extended idling at high engine speeds can produce very high temperatures in the engine and exhaust system, creating the risk of fire or other damage.



Do not park, idle or drive your vehicle on dry grass or other dry ground cover. The emission system heats up the engine compartment and exhaust system, creating the risk of fire.



Do not start the engine in a closed garage or in other enclosed areas. Exhaust fumes can be toxic. Always open the garage door before you start the engine.



If you smell exhaust fumes inside your vehicle, have your vehicle checked by an authorized dealer immediately. Do not drive your vehicle if you smell exhaust fumes.

If you disconnect the battery, your vehicle may exhibit some unusual driving characteristics for approximately 5 miles (8 kilometers) after you reconnect it. This is because the engine management system must realign itself with the engine. You can disregard any unusual driving characteristics during this period.

The powertrain control system meets all Canadian interference-causing equipment standard requirements regulating the impulse electrical field or radio noise.

When you start the engine, avoid pressing the accelerator pedal before and during operation. Only use the accelerator pedal when you have difficulty starting the engine.

## IGNITION SWITCH (If Equipped)



E72128

**0** (off) - The ignition is off.

**Note:** When you switch the ignition off and leave your vehicle, do not leave your key in the ignition. This could cause your vehicle battery to lose charge.

**I** (accessory) - Allows the electrical accessories, such as the radio, to operate while the engine is not running.

**Note:** Do not leave the ignition key in this position for too long. This could cause your vehicle battery to lose charge.

**II** (on) - All electrical circuits are operational and the warning lamps and indicators illuminate.

**III** (start) - cranks the engine.

## KEYLESS STARTING (If Equipped)

**Note:** The system may not function if the passive key is close to metal objects or electronic devices, for example keys or a cell phone.

**Note:** A valid passive key must be located inside your vehicle to switch the ignition on and start your vehicle.



# Starting and Stopping the Engine

## Ignition Modes



The keyless starting system has three modes:

**Off:** Turns the ignition off.

- Without applying the brake pedal, press and release the button once when the ignition is in the on mode, or when your vehicle is running but is not moving.

**On:** All electrical circuits are operational and the warning lamps and indicators illuminate.

- Without applying the brake pedal, press and release the button once.

**Start:** Starts your vehicle. The engine may not start when your vehicle starts.

- Press the brake pedal, and then press the button for any length of time. An indicator light on the button illuminates when the ignition is on and when your vehicle starts.

## STARTING A GASOLINE ENGINE

When you start the engine, the idle speed increases. This helps to warm up the engine. If the engine idle speed does not slow down automatically, have your vehicle checked by an authorized dealer.

**Note:** You can crank the engine for a total of 60 seconds without the engine starting before the starting system temporarily disables. The 60 seconds does not have to be all at once. For example, if you crank the engine three times for 20 seconds each time, without the engine starting, you reached the 60-second time limit. A message appears in the information display alerting you that you exceeded the cranking time. You cannot attempt to start the engine for at least 15 minutes. After 15 minutes, you are limited to a 15-second engine cranking time. You need to wait 60 minutes before you can crank the engine for 60 seconds again.

Before starting your vehicle, check the following:

- Make sure all occupants have fastened their safety belts.
- Make sure the headlamps and electrical accessories are off.
- Make sure the parking brake is on.
- Make sure the transmission is in park (P).
- Switch the ignition on. For vehicles with a keyless ignition, see the following instructions.

## Vehicles with an Ignition Key

**Note:** Do not touch the accelerator pedal.

1. Fully depress the brake pedal.
2. Turn the key to the start position to start the engine.

**Note:** The engine may continue cranking for up to 15 seconds or until it starts.

**Note:** If you cannot start the engine on the first try, wait for a short period and try again.

## Vehicles with Keyless Start

**Note:** Do not touch the accelerator pedal.

# Starting and Stopping the Engine

**Note:** You must have your intelligent access key in your vehicle in order to shift the transmission out of park (P).

1. Fully depress the brake pedal.
2. Press the push button ignition switch.

The system does not function if:

- The passive key frequencies are jammed.
- The key battery has no charge.

If you are unable to start your vehicle, do the following:

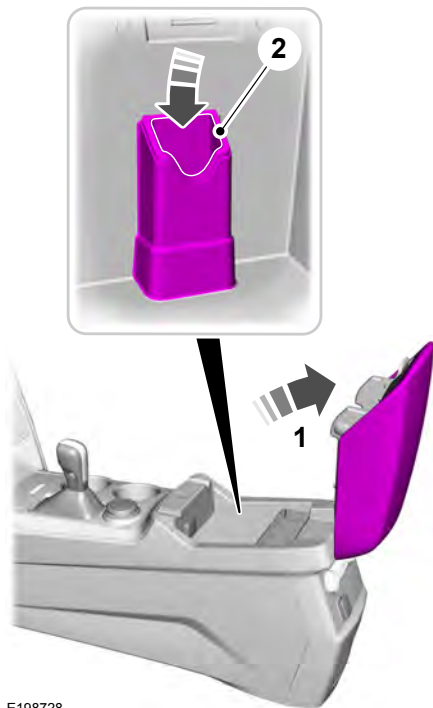

E198728

1. Open the floor console storage compartment lid.

2. Insert the passive key into the backup slot.
3. With the key in this position, press the brake pedal then press the push button ignition switch to switch the ignition on and start your vehicle.

## Fast Restart

The fast restart feature allows you to restart your vehicle within 20 seconds of switching it off, even if it does not detect a valid passive key.

Within 20 seconds of switching the engine off, press the brake pedal and press the push button ignition switch. After 20 seconds, you can no longer start your vehicle if it does not detect a valid passive key.

Once your vehicle starts, it remains running until you press the push button ignition switch, even if your vehicle does not detect a valid passive key. If you open and close a door while your vehicle is running, the system searches for a valid passive key. You cannot start your vehicle if the system does not detect a valid passive key within 20 seconds.

## Failure to Start

If you cannot start the engine after three attempts, wait 10 seconds and follow this procedure:

1. Fully depress the brake pedal.
2. Shift into park (P).
3. Fully depress the accelerator pedal and hold it there.
4. Start the engine.

# Starting and Stopping the Engine

## Automatic Engine Shutdown

For vehicles with a keyless ignition, this feature automatically shuts down the engine if it has been idling for an extended period. The ignition also turns off in order to save battery power. Before your vehicle shuts down, a message appears in the information display showing a timer counting down from 30 seconds. If you do not intervene within 30 seconds, your vehicle shuts down. Another message appears in the information display to inform you that your vehicle has shut down to save fuel. Start your vehicle as you normally do.

## Automatic Engine Shutdown Override

**Note:** You cannot permanently switch off the automatic shutdown feature. When you switch it off temporarily, it turns on at the next ignition cycle.

You can stop the shutdown, or reset the timer, at any point before the 30-second countdown has expired by doing any of the following:

- You can reset the timer by interacting with your vehicle, for example pressing the brake or accelerator pedal.
- You can temporarily switch off the shutdown feature any time the ignition is on using the information display. See **Information Displays** (page 99). The feature only remains off for the current ignition cycle.
- During the 30-second countdown, the system prompts you to press OK or RESET to temporarily switch the feature off for the current ignition cycle only.

## Stopping the Engine When Your Vehicle is Stationary

### Vehicles with an Ignition Key

1. Shift into park (P).

2. Switch the ignition off.
3. Apply the parking brake.

### Vehicles with Keyless Start

1. Shift into park (P).
2. Press the push button ignition switch.
3. Apply the parking brake.

**Note:** The ignition, all electrical circuits and all warning lamps and indicators will be turned off.

**Note:** If the engine is idling for 30 minutes, the ignition and engine automatically shut down.

## Stopping the Engine When Your Vehicle is Moving

### WARNING



Switching off the engine when the vehicle is still moving will result in a loss of brake and steering assistance. The steering will not lock, but higher effort will be required. When the ignition is switched off, some electrical circuits, including air bags, warning lamps and indicators may also be off. If the ignition was turned off accidentally, you can shift into neutral (N) and re-start the engine.

### Vehicles with an Ignition Key

1. Shift into neutral and use the brakes to bring your vehicle to a safe stop.
2. When your vehicle has stopped, shift into park (P) and switch the ignition off.
3. Apply the parking brake.

### Vehicles with Keyless Start

1. Shift into neutral and use the brakes to bring your vehicle to a safe stop.
2. When your vehicle has stopped, shift into park (P).

# Starting and Stopping the Engine

3. Press and hold the push button ignition switch, or press it three times within two seconds.
4. Apply the parking brake.

## Guarding Against Exhaust Fumes

### WARNING



If you smell exhaust fumes inside your vehicle, have your vehicle checked by your authorized dealer immediately. Do not drive your vehicle if you smell exhaust fumes. Carbon monoxide is present in exhaust fumes. Take precautions to avoid its dangerous effects.

## Important Ventilating Information

If you stop your vehicle and then leave the engine idling for long periods, we recommend that you do one of the following:

- Open the windows at least 1 in (3 cm).
- Set your climate control to outside air.

## ENGINE BLOCK HEATER (if

Equipped)

### WARNINGS



Failure to follow engine block heater instructions could result in property damage or serious personal injury.



Do not use your heater with ungrounded electrical systems or two-pronged adapters. There is a risk of electrical shock.



Do not fully close the hood, or allow it to drop under its own weight when using the engine block heater. This could damage the power cable and may cause an electrical short resulting in fire, injury and property damage.

**Note:** *The heater is most effective when outdoor temperatures are below 0°F (-18°C).*

The heater acts as a starting aid by warming the engine coolant. This allows the climate control system to respond quickly. The equipment includes a heater element (installed in the engine block) and a wire harness. You can connect the system to a grounded 120-volt AC electrical source.

We recommend that you do the following for a safe and correct operation:

- Use a 16-gauge outdoor extension cord that is product certified by Underwriter's Laboratory (UL) or Canadian Standards Association (CSA). This extension cord must be suitable for use outdoors, in cold temperatures, and be clearly marked Suitable for Use with Outdoor Appliances. Do not use an indoor extension cord outdoors. This could result in an electric shock or become a fire hazard.
- Use as short an extension cord as possible.
- Do not use multiple extension cords.
- Make sure that when in operation, the extension cord plug and heater cord plug connections are free and clear of water. This could cause an electric shock or fire.
- Make sure your vehicle is parked in a clean area, clear of combustibles.
- Make sure the heater, heater cord and extension cord are firmly connected.
- Check for heat anywhere in the electrical hookup once the system has been operating for approximately 30 minutes.

# Starting and Stopping the Engine

---

- Make sure the system is unplugged and properly stowed before starting and driving your vehicle. Make sure the protective cover seals the prongs of the block heater cord plug when not in use.
- Make sure the heater system is checked for proper operation before winter.

## Using the Engine Block Heater

Make sure the receptacle terminals are clean and dry prior to use. Clean them with a dry cloth if necessary.

The heater uses 0.4 to 1.0 kilowatt-hours of energy per hour of use. The system does not have a thermostat. It achieves maximum temperature after approximately three hours of operation. Using the heater longer than three hours does not improve system performance and unnecessarily uses electricity.

# Fuel and Refueling

## SAFETY PRECAUTIONS

### WARNINGS



Do not overfill the fuel tank. The pressure in an overfilled tank may cause leakage and lead to fuel spray and fire.



The fuel system may be under pressure. If you hear a hissing sound near the fuel filler inlet, do not refuel until the sound stops. Otherwise, fuel may spray out, which could cause serious personal injury.



Fuels can cause serious injury or death if misused or mishandled.



Flow of fuel through a fuel pump nozzle can produce static electricity. This can cause a fire if you are filling an ungrounded fuel container.



Fuel may contain benzene, which is a cancer-causing agent.



When refueling always shut the engine off and never allow sparks or open flames near the fuel tank filler valve. Never smoke or use a cell phone while refueling. Fuel vapor is extremely hazardous under certain conditions. Avoid inhaling excess fumes.

Observe the following guidelines when handling automotive fuel:

- Extinguish all smoking materials and any open flames before refueling your vehicle.
- Always turn off the vehicle before refueling.
- Automotive fuels can be harmful or fatal if swallowed. Fuel such as gasoline is highly toxic and if swallowed can cause death or permanent injury. If fuel is swallowed, call a physician immediately, even if no symptoms are immediately apparent. The toxic effects of fuel may not be visible for hours.
- Avoid inhaling fuel vapors. Inhaling too much fuel vapor of any kind can lead to eye and respiratory tract irritation. In severe cases, excessive or prolonged breathing of fuel vapor can cause serious illness and permanent injury.
- Avoid getting fuel liquid in your eyes. If fuel is splashed in the eyes, remove contact lenses (if worn), flush with water for 15 minutes and seek medical attention. Failure to seek proper medical attention could lead to permanent injury.
- Fuels can also be harmful if absorbed through the skin. If fuel is splashed on the skin, clothing or both, promptly remove contaminated clothing and wash skin thoroughly with soap and water. Repeated or prolonged skin contact with fuel liquid or vapor causes skin irritation.
- Be particularly careful if you are taking Antabuse or other forms of Disulfiram for the treatment of alcoholism. Breathing gasoline vapors could cause an adverse reaction, serious personal injury or sickness. If fuel is splashed on the skin, wash the affected areas immediately with plenty of soap and water. Consult a physician immediately if you experience any adverse reactions.

# Fuel and Refueling

## FUEL QUALITY

### Choosing the Right Fuel



E161513

We recommend regular unleaded gasoline with a minimum pump (R+M)/2 octane rating of 87. Some fuel stations offer fuels posted as regular unleaded gasoline with an octane rating below 87, particularly in high altitude areas. We do not recommend fuels with an octane rating below 87.

For vehicles with EcoBoost engines, to provide improved performance, we recommend premium fuel for severe duty usage such as trailer tow.

Do not use any fuel other than those recommended because they could lead to engine damage that may not be covered by the vehicle Warranty.

**Note:** *Use of any fuel other than those recommended can impair the emission control system and cause a loss of vehicle performance.*

Do not use:

- Diesel fuel.
- Fuels containing kerosene or paraffin.
- Fuel containing more than 15% ethanol or E85 fuel.
- Fuels containing methanol.
- Fuels containing metallic-based additives, including manganese-based compounds.

- Fuels containing the octane booster additive, methylcyclopentadienyl manganese tricarbonyl (MMT).
- Leaded fuel (using leaded fuel is prohibited by law).

The use of fuels with metallic compounds such as methylcyclopentadienyl manganese tricarbonyl (commonly known as MMT), which is a manganese-based fuel additive, will impair engine performance and affect the emission control system.

Do not be concerned if the engine sometimes knocks lightly. However, if the engine knocks heavily while using fuel with the recommended octane rating, contact an authorized dealer to prevent any engine damage.

## FUEL QUALITY - E85

### Choosing the Right Fuel - Flex Fuel Vehicles



E161513

Use regular unleaded gasoline with a minimum pump (R+M)/2 octane rating of 87, or regular unleaded gasoline blended with a maximum of 85% ethanol (E85). Flex fuel vehicles have a yellow fuel filler cap or the fuel tank filler pipe will have a yellow housing or bezel. Some fuel stations offer fuels posted as regular unleaded gasoline with an octane rating below 87, particularly in high altitude areas. Fuels with octane levels below 87 are not recommended.

# Fuel and Refueling

Do not use any fuel other than those recommended because they could lead to engine damage that may not be covered by the vehicle Warranty.

**Note:** *Use of any fuel other than those recommended can impair the emission control system and cause a loss of vehicle performance.*

Do not use:

- Diesel fuel.
- Fuels containing kerosene or paraffin.
- Fuels containing more than 85% ethanol or E100 fuel.
- Fuels containing methanol.
- Fuels containing metallic-based additives, including manganese-based compounds.
- Fuels containing the octane booster additive, methylcyclopentadienyl manganese tricarbonyl (MMT).
- Leaded fuel (using leaded fuel is prohibited by law).

The use of fuels with metallic compounds such as methylcyclopentadienyl manganese tricarbonyl (commonly known as MMT), which is a manganese-based fuel additive, will impair engine performance and affect the emission control system.

Do not be concerned if the engine sometimes knocks lightly. However, if the engine knocks heavily while using fuel with the recommended octane rating, contact an authorized dealer to prevent any engine damage.

## FUEL FILLER FUNNEL LOCATION

The fuel filler funnel is located in the spare wheel storage tray.

## RUNNING OUT OF FUEL

Running out of fuel can cause damage not covered by the vehicle Warranty.

If your vehicle runs out of fuel:

- Add a minimum of 1.3 gal (5 L) of fuel to restart the engine. If your vehicle is out of fuel and on a steep slope, more fuel may be required.
- You may need to switch the ignition from off to on several times after refueling to allow the fuel system to pump the fuel from the tank to the engine. When restarting, cranking time takes a few seconds longer than normal.

## Filling a Portable Fuel Container

Use the following guidelines to avoid electrostatic charge build-up when filling an ungrounded fuel container:

- Only use an approved fuel container to transfer fuel to your vehicle. Place the container on the ground when filling it.
- Do not fill a fuel container when it is inside your vehicle (including the cargo area).
- Keep the fuel pump nozzle in contact with the fuel container when filling it.
- Do not use a device that holds the fuel pump nozzle lever in the fill position.

## Adding Fuel From a Portable Fuel Container

### WARNINGS



Do not insert the nozzle of a fuel container or an aftermarket funnel into the fuel system filler neck. This may damage the fuel system filler neck or its seal and cause fuel to run onto the ground.



# Fuel and Refueling

## WARNINGS



Do not try to pry open or push open the capless fuel system with foreign objects. This could damage the fuel system and its seal and cause injury to you or others.



Do not dispose of fuel in the household refuse or the public sewage system. Use an authorized waste disposal facility.

When refueling the vehicle fuel tank from a fuel container, use the plastic funnel included with your vehicle. See **Fuel Filler Funnel Location** (page 170).

**Note:** Do not use aftermarket funnels as they will not work with the capless fuel system and can damage it.

When refueling the vehicle fuel tank from a fuel container, do the following:

1. Fully open the fuel tank filler door until it engages and remove the fuel tank filler cap.

**Note:** Capless fuel systems do not have a fuel tank filler cap.

2. Fully insert the plastic funnel into the fuel tank filler pipe opening.



E157452

3. Add fuel to your vehicle from the fuel container.
4. Remove the plastic funnel from the fuel tank filler pipe opening.
5. Replace the fuel tank filler cap and close the fuel tank filler door.
6. Clean the plastic funnel and place it back in your vehicle or properly dispose of it.

**Note:** Extra funnels can be purchased from an authorized dealer if you choose to dispose of the funnel.

## REFUELING

### WARNINGS



Fuel vapor burns violently and a fuel fire can cause severe injuries.



Read and follow all the instructions on the pump island.



When refueling always shut the engine off and never allow sparks or open flames near the fuel tank filler valve. Never smoke or use a cell phone while refueling. Fuel vapor is extremely hazardous under certain conditions. Avoid inhaling excess fumes.



Stay outside your vehicle and do not leave the fuel pump unattended when refueling your vehicle. This is against the law in some places.



Keep children away from the fuel pump; never let children pump fuel.



Wait at least 10 seconds before removing the fuel pump nozzle to allow any residual fuel to drain into the fuel tank.



Stop refueling when the fuel pump nozzle automatically shuts off for the first time. Failure to follow this will fill the expansion space in the fuel tank and could lead to fuel overflowing.

# Fuel and Refueling

## WARNINGS



Do not remove the fuel pump nozzle from its fully inserted position when refueling.

Use the following guidelines to avoid electrostatic charge build-up, which can produce a spark, when filling an ungrounded fuel container:

- Place approved fuel container on the ground.
- Do not fill a fuel container while it is in the vehicle (including the cargo area).
- Keep the fuel pump nozzle in contact with the fuel container while filling.
- Do not use a device that would hold the fuel pump handle in the fill position.

## Easy Fuel™ Capless Fuel System

### WARNING



The fuel system may be under pressure. If you hear a hissing sound near the fuel filler door, do not refuel until the sound stops. Otherwise, fuel may spray out, which could cause serious personal injury.

When fueling your vehicle:

1. When your vehicle has stopped, shift into park (P) and switch the ignition off.
2. Fully open the fuel tank filler door until it engages.

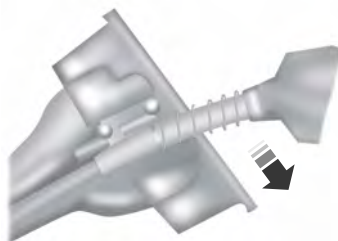

E156032

3. Insert the fuel pump nozzle up to the first notch on the nozzle. Hold handle higher during insertion for easier access. Leave the fuel pump nozzle fully inserted until you are done pumping.

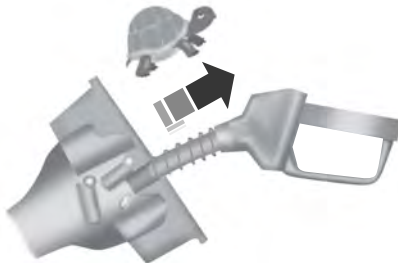

E154765

4. Remove the fuel filler nozzle and fully close the fuel tank filler door.

**Note:** A fuel spillage concern may occur if overfilling the fuel tank. Do not overfill the tank. The fill pipe is equipped with a drain hole. Excess fuel due to overfill may drain through the drain hole and drip onto the ground.

If the fuel fill inlet was not properly closed, a service engine warning lamp may appear on the instrument cluster.

At the next opportunity, do the following:

# Fuel and Refueling

---

1. Stop your vehicle as soon as safely possible and shift the transmission into park (P).
  2. Switch the ignition off.
  3. Open the fuel filler door and remove any visible debris from the fuel fill opening.
  4. Insert either the fuel fill nozzle or the fuel fill funnel provided with the vehicle several times to allow the inlet to close properly. This will dislodge any debris preventing the inlet from sealing.
- The usable capacity of the fuel tank is the amount of fuel that you can add to the fuel tank when the fuel gauge indicates empty, before the first fuel filler nozzle automatic shutoff event.
  - The advertised capacity is equal to the volumetric difference between actual fuel fill before the first fuel filler nozzle automatic shutoff event and the fuel quantity when the fuel gauge indicates empty. See **Capacities and Specifications** (page 331). It is the usable capacity minus the empty reserve.
  - Due to the empty reserve, you may be able to add more fuel than the advertised capacity of the fuel tank when the fuel gauge indicates empty.

If this action corrects the problem, the message may not reset immediately. It may take several driving cycles for the message to turn off. A driving cycle consists of an engine start-up (after 4 or more hours with the engine off) followed by city or highway driving. Continuing to drive with the message on may cause the service engine soon lamp to turn on as well.

## FUEL CONSUMPTION

Empty reserve is the amount of fuel remaining in the tank after the fuel gauge indicates empty. The amount of usable fuel in the empty reserve varies and should not be relied upon to increase driving range.

## Filling the Fuel Tank

For consistent results when refueling:

- Turn the ignition off before fueling; an inaccurate reading results if the engine is left running.
- Use the same fill rate (low-medium-high) each time the tank is filled.
- Allow no more than one automatic shut-off when refueling.

Results are most accurate when the filling method is consistent.

## Calculating Fuel Economy

Do not measure fuel economy during the first 1,000 mi (1,600 km) of driving (this is your engine's break-in period). A more accurate measurement is obtained after 2,000 mi (3,200 km) to 3,000 mi (4,800 km). Also, fuel expense, frequency of fill ups or fuel gauge readings are not accurate ways to measure fuel economy.

1. Fill the fuel tank completely and record the initial odometer reading.

# Fuel and Refueling

2. Each time you fill the fuel tank, record the amount of fuel added.
3. After at least three fill ups, fill the fuel tank and record the current odometer reading.
4. Subtract your initial odometer reading from the current odometer reading.

To calculate L/100 km (liters per 100 kilometers) fuel consumption, multiply the liters used by 100, then divide by kilometers traveled. To calculate MPG (miles per gallon) fuel consumption, divide miles traveled by gallons used.

Keep a record for at least one month and record the type of driving (city or highway). This provides an accurate estimate of your vehicle's fuel economy under current driving conditions. Keeping records during summer and winter will show how temperature impacts fuel economy.

## Conditions

- Heavily loading your vehicle reduces fuel economy.
- Carrying unnecessary weight in your vehicle may reduce fuel economy.
- Adding certain accessories to your vehicle such as bug deflectors, rollbars or light bars, running boards and ski racks may reduce fuel economy.
- Using fuel blended with alcohol may lower fuel economy.
- Fuel economy may decrease with lower temperatures.
- Fuel economy may decrease when driving short distances.
- You will get better fuel economy when driving on flat terrain than when driving on hilly terrain.

## EMISSION CONTROL SYSTEM

### WARNINGS



Do not park, idle, or drive your vehicle in dry grass or other dry ground cover. The emission system heats up the engine compartment and exhaust system, which can start a fire.



Exhaust leaks may result in entry of harmful and potentially lethal fumes into the passenger compartment. If you smell exhaust fumes inside your vehicle, have your dealer inspect your vehicle immediately. Do not drive if you smell exhaust fumes.

Your vehicle is equipped with various emission control components and a catalytic converter that will enable your vehicle to comply with applicable exhaust emission standards. To make sure that the catalytic converter and other emission control components continue to work properly:

- Use only the specified fuel listed.
- Avoid running out of fuel.
- Do not turn off the ignition while your vehicle is moving, especially at high speeds.
- Have the items listed in scheduled maintenance information performed according to the specified schedule.

The scheduled maintenance items listed in scheduled maintenance information are essential to the life and performance of your vehicle and to its emissions system. See **Scheduled Maintenance** (page 483).

If you use parts other than Ford, Motorcraft or Ford-authorized parts for maintenance replacements, or for service of components affecting emission control, such non-Ford parts should be the equivalent to genuine Ford Motor Company parts in performance and durability.

# Fuel and Refueling

Illumination of the service engine soon indicator, charging system warning light or the temperature warning light, fluid leaks, strange odors, smoke or loss of engine power could indicate that the emission control system is not working properly.

An improperly operating or damaged exhaust system may allow exhaust to enter the vehicle. Have a damaged or improperly operating exhaust system inspected and repaired immediately.

Do not make any unauthorized changes to your vehicle or engine. By law, vehicle owners and anyone who manufactures, repairs, services, sells, leases, trades vehicles, or supervises a fleet of vehicles are not permitted to intentionally remove an emission control device or prevent it from working. Information about your vehicle's emission system is on the Vehicle Emission Control Information Decal located on or near the engine. This decal also lists engine displacement

Please consult your warranty information for complete details.

## On-Board Diagnostics (OBD-II)

Your vehicle has a computer known as the on-board diagnostics system (OBD-II) that monitors the engine's emission control system. The system protects the environment by making sure that your vehicle continues to meet government emission standards. The OBD-II system also assists a service technician in properly servicing your vehicle.



When the service engine soon indicator illuminates, the OBD-II system has detected a malfunction. Temporary malfunctions may cause the service engine soon indicator to illuminate.

Examples of temporary malfunctions are:

- the vehicle has run out of fuel—the engine may misfire or run poorly
- poor fuel quality or water in the fuel—the engine may misfire or run poorly
- the fuel fill inlet may not have closed properly. See **Refueling** (page 171).
- driving through deep water—the electrical system may be wet.

You can correct these temporary malfunctions by filling the fuel tank with good quality fuel, properly closing the fuel fill inlet or letting the electrical system dry out. After three driving cycles without these or any other temporary malfunctions present, the service engine soon indicator should stay off the next time you start the engine. A driving cycle consists of a cold engine startup followed by mixed city/highway driving. No additional vehicle service is required.

If the service engine soon indicator remains on, have your vehicle serviced at the first available opportunity. Although some malfunctions detected by the OBD-II may not have symptoms that are apparent, continued driving with the service engine soon indicator on can result in increased emissions, lower fuel economy, reduced engine and transmission smoothness, and lead to more costly repairs.

## Readiness for Inspection/Maintenance (I/M) Testing

Some state/provincial and local governments may have Inspection/Maintenance (I/M) programs to inspect the emission control equipment on your vehicle. Failure to pass this inspection could prevent you from getting a vehicle registration.

## Fuel and Refueling

---



If the service engine soon indicator is on or the bulb does not work, you may need to have the vehicle serviced. See On-Board Diagnostics (OBD-II).

Your vehicle may not pass the I/M test if the service engine soon indicator is on or not working properly (bulb is burned out), or if the OBD-II system has determined that some of the emission control systems have not been properly checked. In this case, your vehicle is not ready for I/M testing.

If the vehicle's engine or transmission has just been serviced, or the battery has recently run down or been replaced, the OBD-II system may indicate that the vehicle is not ready for I/M testing. To determine if the vehicle is ready for I/M testing, turn the ignition key to the on position for 15 seconds without cranking the engine. If the service engine soon indicator blinks eight times, it means that the vehicle is not ready for I/M testing; if the service engine soon indicator stays on solid, it means that the vehicle is ready for I/M testing.

The OBD-II system monitors the emission control system during normal driving. A complete check may take several days. If the vehicle is not ready for I/M testing, you may need to perform the following driving cycle consisting of mixed city and highway driving:

Drive on an expressway or highway for a steady 15 minutes, followed by 20 minutes of stop-and-go driving with at least four 30-second idle periods.

Allow the vehicle to sit for at least eight hours without starting the engine. Then, start the engine and complete the above driving cycle. The engine must warm up to its normal operating temperature. Once started, do not turn off the engine until the above driving cycle is complete. If the vehicle is still not ready for I/M testing, you will have to repeat the above driving cycle.

# Transmission

## AUTOMATIC TRANSMISSION

### WARNINGS



Always set the parking brake fully and make sure you shift the gearshift lever to park (P). Switch the ignition off and remove the key whenever you leave your vehicle.



Do not apply the brake pedal and accelerator pedal simultaneously. Applying both pedals simultaneously for more than a few seconds will limit engine rpm, which may result in difficulty maintaining speed in traffic and could lead to serious injury.

## Understanding the Positions of Your Automatic Transmission

### Putting your vehicle in gear:

1. Fully press down the brake pedal.
2. Press and hold the button on the front of the gearshift lever.
3. Move the gearshift lever into the desired gear.
4. Release the button and your transmission will remain in the selected gear.



E142628

### Park (P)

This position locks the transmission and prevents the wheels from turning.

### Reverse (R)

With the gearshift lever in reverse (R), your vehicle will move backward. Always come to a complete stop before shifting into and out of reverse (R).

### Neutral (N)

With the gearshift lever in neutral (N), your vehicle can be started and is free to roll. Hold the brake pedal down while in this position.

### Drive (D)

Drive (D) is the normal driving position for the best fuel economy. The overdrive function allows automatic upshifts and downshifts through gears one through six.

### Sport (S)

Moving the gearshift lever to sport (S):

- Provides additional grade (engine) braking and extends lower gear operation to enhance performance for uphill climbs, hilly terrain or mountainous areas. This will increase engine RPM during engine braking.
- Provides additional lower gear operation through the automatic transmission shift strategy.
- Gears are selected more quickly and at higher engine speeds.

## SelectShift Automatic™ Transmission

Your vehicle is equipped with a SelectShift Automatic transmission. The SelectShift Automatic transmission gives you the ability to change gears up or down (without a clutch) as desired.

# Transmission

In order to prevent the engine from running at too low an RPM, which may cause it to stall, SelectShift still automatically makes some downshifts if it has determined that you have not downshifted in time. Although SelectShift makes some downshifts for you, it still allows you to downshift at any time as long as the SelectShift determines that damage will not be caused to the engine from over-revving.

**Note:** *Engine damage may occur if you maintain excessive engine revving without shifting.*

SelectShift does not automatically upshift, even if the engine is approaching the RPM limit. It must be shifted manually by pressing the + button. Notice should be taken of the shift indicator lamp, which alerts you when to shift to make sure you achieve the highest level or efficiency and fuel economy.

**Pull the + paddle on the steering wheel to activate SelectShift.**

- Pull the right paddle (+) to upshift.
- Pull the left paddle (-) to downshift.



SelectShift in drive (D):

- Provides a temporary manual mode for performing more demanding maneuvers where extra control of gear selection is required (for example, when towing or overtaking). This mode will hold a selected gear for a temporary period of time dependent on driver inputs (for example, steering or accelerator pedal input).

SelectShift in sport (S):

- Provides a permanent manual gear selection where full control of gear selection is required.



To exit SelectShift mode shift the transmission into another gear (for example, drive [D]).

The instrument cluster displays your currently selected gear. If a gear is requested but not available due to vehicle conditions (low speed, too high engine speed for requested gear selection), the current gear will flash three times.

**Note:** *At full accelerator pedal travel, the transmission automatically downshifts for maximum performance.*

## Brake-Shift Interlock

### WARNINGS

-  Do not drive your vehicle until you verify that the brake lamps are working.
-  When doing this procedure, you need to take the transmission out of park (P) which means your vehicle can roll freely. To avoid unwanted vehicle movement, always fully set the parking brake prior to doing this procedure. Use wheels chocks if appropriate.
-  If the parking brake is fully released, but the brake warning lamp remains illuminated, the brakes may not be working properly. Have your vehicle checked as soon as possible.



# Transmission

Use the brake shift interlock lever to move the gearshift lever from the park position in the event of an electrical malfunction or if your vehicle has a dead battery.

Apply the parking brake and turn the ignition off before performing this procedure.

1. Insert a screwdriver (or similar tool) between the shifter bezel and the top finish panel.
2. Use the tool to unsnap the shifter bezel from the finish panel.

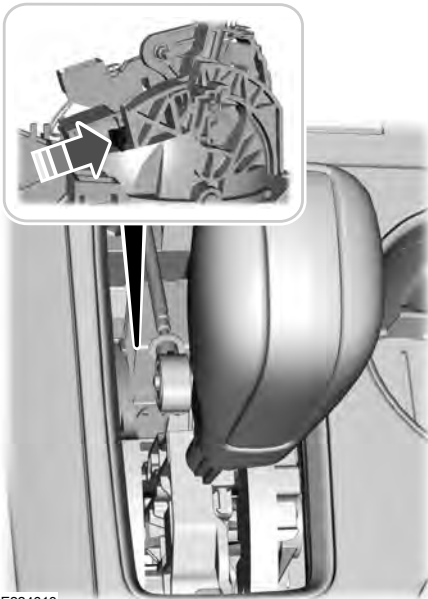

E224613

3. Locate the white lever located on the left side of the shifter.
4. Using the tool move the white lever towards the front of the shifter.
5. While holding the white lever in the forward position, move the shifter from the park position.

6. Press the shifter bezel back into the top finish panel until it snaps back into position.
7. Apply the brake pedal, start the vehicle and release the parking brake.

**Note:** See your authorized dealer as soon as possible if this procedure is used.

## If Your Vehicle Gets Stuck In Mud or Snow

**Note:** Do not rock the vehicle if the engine is not at normal operating temperature or damage to the transmission may occur.

**Note:** Do not rock the vehicle for more than a minute or damage to the transmission and tires may occur, or the engine may overheat.

If your vehicle gets stuck in mud or snow, it may be rocked out by shifting between forward and reverse gears, stopping between shifts in a steady pattern. Press lightly on the accelerator in each gear.

## Four-Wheel Drive (If Equipped)

### PRINCIPLE OF OPERATION

This system is a proactive system. It has the ability to anticipate wheel slip and transfer torque to the rear wheels before slip occurs. Even when wheel slip is not present, the system is continuously making adjustments to the torque distribution, in an attempt to improve straight line and cornering behavior, both on and off road.

The system automatically turns on every time you switch the ignition on.

All components of the system are sealed and do not require maintenance.

### USING FOUR-WHEEL DRIVE

#### WARNING



Vehicles with a higher center of gravity such as utility and four-wheel drive vehicles handle differently than vehicles with a lower center of gravity. Utility and four-wheel drive vehicles are not designed for cornering at speeds as high as passenger cars any more than low-slung sports cars are designed to perform satisfactorily under off-road conditions. Avoid sharp turns, excessive speed and abrupt maneuvers in these vehicles. Failure to drive cautiously could result in an increased risk of loss of vehicle control, vehicle rollover, personal injury and death.

The intelligent 4WD system continuously monitors vehicle conditions and automatically adjusts the power distribution between the front and rear wheels. It combines transparent all-surface operation with highly capable four-wheel drive.

The 4WD system is always active and requires no driver input. It is capable of handling all road conditions, including street and highway driving as well as off-road and winter driving. The driver can optimize more 4WD control by moving the terrain management switch for the correct terrain. See **Using Terrain Response** (page 191).

**Note:** A warning message will be displayed in the information display when an 4WD system fault is present. See **Information Messages** (page 113). An 4WD system fault will cause the 4WD system to default to front-wheel drive only mode. When this warning message is displayed, have your vehicle serviced at an authorized dealer.

**Note:** A warning message will be displayed in the information display if the 4WD system has overheated. See **Information Messages** (page 113). This condition may occur if the vehicle was operated in extreme conditions with excessive wheel slip, such as deep sand. To resume normal 4WD function as soon as possible, stop the vehicle in a safe location and stop the engine for at least 10 minutes. After the engine has been restarted and the 4WD system has adequately cooled, the warning message will turn off and normal 4WD function will return.

Do not use a spare tire of a different size other than the tire provided. If the mini-spare tire is installed, the 4WD system may disable automatically and enter front-wheel drive only mode to protect driveline components. This condition will be indicated by a warning in the information display. See **Information Messages** (page 113). If there is a warning message in the information display from using the spare tire, this indicator should turn off after reinstalling the repaired or replaced normal road tire and cycling the ignition off and on. It is recommended to

## Four-Wheel Drive (If Equipped)

reinstall the repaired or replaced road tire as soon as possible. Major dissimilar tire sizes between the front and rear axles could cause the 4WD system to stop functioning and default to front-wheel drive or damage the 4WD system.

### How Your Vehicle Differs From Other Vehicles

Truck and utility vehicles can differ from some other vehicles. Your vehicle may be higher to allow it to travel over rough terrain without getting hung up or damaging underbody components.

The differences that make your vehicle so versatile also make it handle differently than an ordinary passenger car.

Maintain steering wheel control at all times, especially in rough terrain. Since sudden changes in terrain can result in abrupt steering wheel motion, make sure you grip the steering wheel from the outside. Do not grip the spokes.

Drive cautiously to avoid vehicle damage from concealed objects such as rocks and stumps.

You should either know the terrain or examine maps of the area before driving. Map out your route before driving in the area. To maintain steering and braking control of your vehicle, you must have all four wheels on the ground and they must be rolling, not sliding or spinning.

### Driving In Special Conditions With Four-Wheel Drive (4WD)

**Note:** *4WD vehicles are equipped for driving on sand, snow, mud and rough roads and have operating characteristics that are somewhat different from conventional vehicles, both on and off the highway.*

### Basic operating principles in special conditions

- Drive slower in strong crosswinds which can affect the normal steering characteristics of your vehicle.
- Be extremely careful when driving on pavement made slippery by loose sand, water, gravel, snow or ice.

### If Your Vehicle Goes Off the Edge of the Pavement

- If your vehicle goes off the edge of the pavement, slow down, but avoid severe brake application, ease the vehicle back onto the pavement only after reducing your speed. Do not turn the steering wheel too sharply while returning to the road surface.
- It may be safer to stay on the apron or shoulder of the road and slow down gradually before returning to the pavement. You may lose control if you do not slow down or if you turn the steering wheel too sharply or abruptly.
- It often may be less risky to strike small objects, such as highway reflectors, with minor damage to your vehicle rather than attempt a sudden return to the pavement which could cause the vehicle to slide sideways out of control or rollover. Remember, your safety and the safety of others should be your primary concern.

### If Your Vehicle Gets Stuck

#### WARNINGS



Always set the parking brake fully and make sure the transmission is in P (Park). Turn the ignition to the lock position or turn the vehicle off using the start/stop button and remove the key whenever you leave your vehicle.

## Four-Wheel Drive (If Equipped)

### WARNINGS



If the parking brake is fully released, but the brake warning lamp remains illuminated, the brakes may not be working properly. See your authorized dealer.



Do not spin the wheels at over 35 mph (56 km/h). The tires may fail and injure a passenger or bystander.

**Note:** Do not rock the vehicle if the engine is not at normal operating temperature or damage to the transmission may occur.

**Note:** Do not rock the vehicle for more than a few minutes or damage to the transmission and tires may occur or the engine may overheat.

If your vehicle gets stuck in mud or snow it may be rocked out by shifting between forward and reverse gears, stopping between shifts, in a steady pattern. Press lightly on the accelerator in each gear.

If your vehicle is equipped with AdvanceTrac® with Roll Stability Control™, it may be beneficial to disengage the AdvanceTrac® with Roll Stability Control™ system while attempting to rock the vehicle.

### Emergency Maneuvers

- In an unavoidable emergency situation where a sudden sharp turn must be made, remember to avoid "over-driving" your vehicle (i.e., turn the steering wheel only as rapidly and as far as required to avoid the emergency). Excessive steering will result in less vehicle control, not more. Additionally, smooth variations of the accelerator and/or brake pedal pressure should be utilized if changes in vehicle speed are called for. Avoid

abrupt steering, acceleration or braking which could result in an increased risk of loss of vehicle control, vehicle rollover and/or personal injury. Use all available road surface to return the vehicle to a safe direction of travel.

- In the event of an emergency stop, avoid skidding the tires and do not attempt any sharp steering wheel movements.
- If the vehicle goes from one type of surface to another (i.e., from concrete to gravel) there will be a change in the way the vehicle responds to a maneuver (steering, acceleration or braking). Again, avoid these abrupt inputs.

### Sand

When driving over sand, try to keep all four wheels on the most solid area of the trail. Avoid reducing the tire pressures but shift to a lower gear and drive steadily through the terrain. Apply the accelerator slowly and avoid spinning the wheels.

Avoid excessive speed because vehicle momentum can work against you and cause the vehicle to become stuck to the point that assistance may be required from another vehicle. Remember, you may be able to back out the way you came if you proceed with caution.

### Mud and Water

**Note:** Driving through deep water may damage your vehicle.

If you must drive through high water, drive slowly. Traction or brake capability may be limited.

When driving through water, determine the depth; avoid water higher than the bottom of the hubs (if possible) and proceed slowly. If the ignition system gets wet, the vehicle may stall.

## Four-Wheel Drive (If Equipped)

Once through water, always try the brakes. Wet brakes do not stop the vehicle as effectively as dry brakes. Drying can be improved by moving your vehicle slowly while applying light pressure on the brake pedal.

Be cautious of sudden changes in vehicle speed or direction when you are driving in mud. Even 4WD vehicles can lose traction in slick mud. As when you are driving over sand, apply the accelerator slowly and avoid spinning your wheels. If the vehicle does slide, steer in the direction of the slide until you regain control of the vehicle.

After driving through mud, clean off residue stuck to rotating driveshafts and tires. Excess mud stuck on tires and rotating driveshafts causes an imbalance that could damage drive components.



E143950

“Tread Lightly” is an educational program designed to increase public awareness of land-use regulations and responsibilities in our nations wilderness areas. Ford Motor Company joins the U.S. Forest Service and the Bureau of Land Management in encouraging you to help preserve our national forest and other public and private lands by “treading lightly.”

### Driving on Hilly or Sloping Terrain

**Note:** Avoid driving crosswise or turning on steep slopes or hills. A danger lies in losing traction, slipping sideways and possibly rolling over. Whenever driving on a hill, determine beforehand the route you will use. Do not drive over the crest of a hill without seeing what conditions are on the other side. Do not drive in reverse over a hill without the aid of an observer.

Although natural obstacles may make it necessary to travel diagonally up or down a hill or steep incline, you should always try to drive straight up or straight down.

When climbing a steep slope or hill, start in a lower gear rather than downshifting to a lower gear from a higher gear once the ascent has started. This reduces strain on the engine and the possibility of stalling.

If you do stall out, do not try to turn around because you might roll over. It is better to back down to a safe location.

Apply just enough power to the wheels to climb the hill. Too much power will cause the tires to slip, spin or lose traction, resulting in loss of vehicle control.



E143949

Descend a hill in the same gear you would use to climb up the hill to avoid excessive brake application and brake overheating. Do not descend in neutral; instead, disengage overdrive or manually shift to a lower gear. When descending a steep hill, avoid sudden hard braking as you could lose control. The front wheels have to be turning in order to steer the vehicle.

Your vehicle has anti-lock brakes, therefore apply the brakes steadily. Do not “pump” the brakes.

## Four-Wheel Drive (If Equipped)

### Driving on Snow and Ice

#### WARNING



If you are driving in slippery conditions that require tire chains or cables, then it is critical that you drive cautiously. Keep speeds down, allow for longer stopping distances and avoid aggressive steering to reduce the chances of a loss of vehicle control which can lead to serious injury or death. If the rear end of the vehicle slides while cornering, steer in the direction of the slide until you regain control of the vehicle.

**Note:** *Excessive tire slippage can cause driveline damage.*

4WD vehicles have advantages over 2WD vehicles in snow and ice but can skid like any other vehicle.

Should you start to slide while driving on snowy or icy roads, turn the steering wheel in the direction of the slide until you regain control.

Avoid sudden applications of power and quick changes of direction on snow and ice. Apply the accelerator slowly and steadily when starting from a full stop.

Avoid sudden braking as well. Although an 4WD vehicle may accelerate better than a two-wheel drive vehicle in snow and ice, it won't stop any faster, because as in other vehicles, braking occurs at all four wheels. Do not become overconfident as to road conditions.

Make sure you allow sufficient distance between you and other vehicles for stopping. Drive slower than usual and consider using one of the lower gears. In emergency stopping situations, apply the brake steadily. Since your vehicle is equipped with a four wheel (ABS), do not "pump" the brakes. See **Hints on Driving With Anti-Lock Brakes** (page 185).

### Maintenance and Modifications

The suspension and steering systems on your vehicle have been designed and tested to provide predictable performance whether loaded or empty and durable load carrying capability. For this reason, Ford Motor Company strongly recommends that you do not make modifications such as adding or removing parts (such as lowering kits or stabilizer bars) or by using replacement parts not equivalent to the original factory equipment.

Any modifications to a vehicle that raise the center of gravity can make it more likely the vehicle will rollover as a result of a loss of control. Ford Motor Company recommends that caution be used with any vehicle equipped with a high load or device (such as ladder or luggage racks).

Failure to maintain your vehicle properly may void the warranty, increase your repair cost, reduce vehicle performance and operational capabilities and adversely affect driver and passenger safety. Frequent inspection of vehicle chassis components is recommended if the vehicle is subjected to off-highway usage.

# Brakes

## GENERAL INFORMATION

**Note:** Occasional brake noise is normal. If a metal-to-metal, continuous grinding or continuous squeal sound is present, the brake linings may be worn-out. Have the system checked by an authorized dealer. If your vehicle has continuous vibration or shudder in the steering wheel while braking, have it checked by an authorized dealer.

**Note:** Brake dust may accumulate on the wheels, even under normal driving conditions. Some dust is inevitable as the brakes wear and does not contribute to brake noise. See **Cleaning the Alloy Wheels** (page 301).

**Note:** Depending on applicable laws and regulations in the country for which your vehicle was originally built, your brake lamps may flash during heavy braking. Following this, your hazard lights may also flash when your vehicle comes to a stop.



See **Cleaning the Alloy Wheels** (page 301).

Wet brakes result in reduced braking efficiency. Gently press the brake pedal a few times when driving from a car wash or standing water to dry the brakes.

## Brake Over Accelerator

In the event the accelerator pedal becomes stuck or entrapped, apply steady and firm pressure to the brake pedal to slow the vehicle and reduce engine power. If you experience this condition, apply the brakes and bring your vehicle to a safe stop. Move the transmission to park (P), switch the engine off and apply the parking brake. Inspect the accelerator pedal for any interference. If none are found and the condition persists, have your vehicle towed to the nearest authorized dealer.

## Brake Assist

Brake assist detects when you brake rapidly by measuring the rate at which you press the brake pedal. It provides maximum braking efficiency as long as you press the pedal, and can reduce stopping distances in critical situations.

## Anti-lock Brake System

This system helps you maintain steering control during emergency stops by keeping the brakes from locking.



This lamp momentarily illuminates when you turn the ignition on. If the light does not illuminate during start up, remains on or flashes, the system may be disabled. Have the system checked by an authorized dealer. If the anti-lock brake system is disabled, normal braking is still effective.



If the brake warning lamp illuminates when you release the parking brake, have the system checked by an authorized dealer.

## HINTS ON DRIVING WITH ANTI-LOCK BRAKES

**Note:** When the system is operating, the brake pedal may pulse and may travel further. Maintain pressure on the brake pedal. You may also hear a noise from the system. This is normal.

The anti-lock braking system will not eliminate the risks when:

- You drive too closely to the vehicle in front of you.
- Your vehicle is hydroplaning.
- You take corners too fast.
- The road surface is poor.

# Brakes

## PARKING BRAKE

### WARNING



Always set the parking brake fully and make sure the transmission is locked in park (P). Failure to set the parking brake and engage park could result in vehicle roll-away, property damage or bodily injury.

To set the parking brake, press the parking brake pedal down to its fullest extent. The brake warning lamp in the instrument cluster will illuminate and remains illuminated until the parking brake is released.

To release the parking brake, press the parking brake pedal down again.

If you are parking your vehicle on a grade or with a trailer, press and hold the brake pedal down, then set the parking brake. There may be a little vehicle movement as the parking brake sets to hold the vehicle's weight. This is normal and should be no reason for concern. If needed, press and hold the service brake pedal down, then try reapplying the parking brake. Chock the wheels if required. If the parking brake cannot hold the weight of the vehicle, the parking brake may need to be serviced or the vehicle may be overloaded.

## HILL START ASSIST

### WARNINGS



The system does not replace the parking brake. When you leave your vehicle, always apply the parking brake. Failure to leave your vehicle securely parked may lead to a crash or injury. See **Parking Brake** (page 186).

### WARNINGS



You must remain in your vehicle when the system turns on. At all times, you are responsible for controlling your vehicle, supervising the system and intervening, if required. Failure to take care may result in the loss of control of your vehicle, serious personal injury or death.



The system will turn off if a malfunction is apparent or if you rev the engine excessively. Failure to take care may result in the loss of control of your vehicle, serious personal injury or death.

The system makes it easier to pull away when your vehicle is on a slope without the need to use the parking brake.

When the system is active, your vehicle remains stationary on the slope for two to three seconds after you release the brake pedal. This allows time to move your foot from the brake to the accelerator pedal. The system releases the brakes automatically once the engine has developed sufficient torque to prevent your vehicle from rolling down the slope. This is an advantage when pulling away on a slope, for example from a car park ramp, traffic lights or when reversing uphill into a parking space.

**Note:** *The system only functions when you bring your vehicle to a complete standstill in an uphill gear (for example, drive (D) when facing uphill or reverse (R) when facing downhill).*

**Note:** *There is no warning light to indicate the system is either on or off.*

### Using Hill Start Assist

1. Press the brake pedal to bring your vehicle to a complete standstill. Keep the brake pedal pressed.



# Brakes

---

2. If the sensors detect that your vehicle is on a slope, the system activates automatically.
3. When you remove your foot from the brake pedal, your vehicle remains on the slope without rolling away for about two to three seconds. This hold time automatically extends if you are in the process of driving off.
4. Drive off in the normal manner. The system releases the brakes automatically.

**Note:** *When you remove your foot from the brake pedal and press the pedal again when the system is active, you will experience significantly reduced brake pedal travel. This is normal.*

## Switching the System On and Off

### Vehicles with Manual Transmission

You can switch this feature on or off in the information display. The system remembers the last setting when you start your vehicle.

### Vehicles with Automatic Transmission

You cannot turn the system on or off. When you switch the ignition on, the system automatically turns on.

# Traction Control

## PRINCIPLE OF OPERATION

The traction control system helps avoid drive wheel spin and loss of traction.

If your vehicle begins to slide, the system applies the brakes to individual wheels and, when needed, reduces engine power at the same time. If the wheels spin when accelerating on slippery or loose surfaces, the system reduces engine power in order to increase traction.

## USING TRACTION CONTROL

### WARNING



The stability and traction control light illuminates steadily if the system detects a failure. Make sure you did not manually disable the traction control system using the information display controls or the switch. If the stability control and traction control light is still illuminating steadily, have the system serviced by an authorized dealer immediately. Operating your vehicle with the traction control disabled could lead to an increased risk of loss of vehicle control, vehicle rollover, personal injury and death.

The system automatically turns on each time you switch the ignition on.

If your vehicle is stuck in mud or snow, switching traction control off may be beneficial as this allows the wheels to spin.

**Note:** *When you switch traction control off, stability control remains fully active.*

## Switching the System Off

When you switch the system off or on, a message appears in the information display showing system status.

You can switch the system off by either using the information display controls or the switch.

## Using the Information Display Controls

You can switch this feature off or on in the information display. See **General Information** (page 99).

## Using a Switch (If Equipped)

Use the traction control switch on the instrument panel to switch the system off or on.

## System Indicator Lights and Messages



The stability and traction control light:

- Temporarily illuminates on engine start-up.
- Flashes when a driving condition activates either of the systems.
- Illuminates if a problem occurs in either of the systems.



The stability and traction control off light temporarily illuminates on engine start-up and stays on when you switch the traction control system off.

# Stability Control

## PRINCIPLE OF OPERATION

### WARNINGS



Vehicle modifications involving braking system, aftermarket roof racks, suspension, steering system, tire construction and wheel and tire size may change the handling characteristics of your vehicle and may adversely affect the performance of the electronic stability control system. In addition, installing any stereo loudspeakers may interfere with and adversely affect the electronic stability control system. Install any aftermarket stereo loudspeaker as far as possible from the front center console, the tunnel, and the front seats in order to minimize the risk of interfering with the electronic stability control sensors. Reducing the effectiveness of the electronic stability control system could lead to an increased risk of loss of vehicle control, vehicle rollover, personal injury and death.



Remember that even advanced technology cannot defy the laws of physics. It's always possible to lose control of a vehicle due to inappropriate driver input for the conditions. Aggressive driving on any road condition can cause you to lose control of your vehicle increasing the risk of personal injury or property damage. Activation of the electronic stability control system is an indication that at least some of the tires have exceeded their ability to grip the road; this could reduce the operator's ability to control the vehicle potentially resulting in a loss of vehicle control, vehicle rollover, personal injury and death. If your electronic stability control system activates, SLOW DOWN.

The system automatically turns on each time you switch the ignition on.

If a driving condition activates either the stability control or the traction control system you may experience the following conditions:

- The stability and traction control light flashes.
- Your vehicle slows down.
- Reduced engine power.
- A vibration in the brake pedal.
- The brake pedal is stiffer than usual.
- If the driving condition is severe and your foot is not on the brake, the brake pedal may move as the systems applies higher brake forces.

The stability control system has several features built into it to help you maintain control of your vehicle:

### Electronic Stability Control

The system enhances your vehicle's ability to prevent skids or lateral slides by applying brakes to one or more of the wheels individually and, if necessary, reducing engine power.

### Roll Stability Control

The system enhances your vehicle's ability to prevent rollovers by detecting your vehicle's roll motion and the rate at which it changes by applying the brakes to one or more wheels individually.

### Curve Control

The system enhances your vehicle's ability to follow the road when cornering severely or avoiding objects in the roadway. Curve Control operates by reducing engine power and, if necessary, applying brakes to one or more of the wheels individually.

# Stability Control

## Traction Control

The system enhances your vehicle's ability to maintain traction of the wheels by detecting and controlling wheel spin. See **Using Traction Control** (page 188).

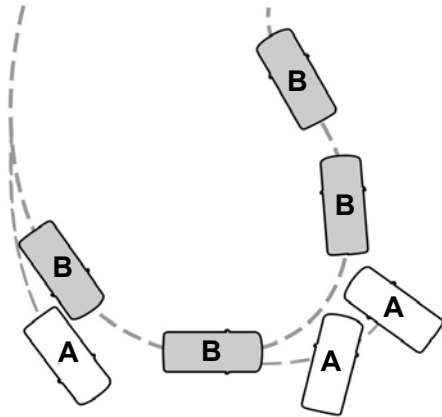

E72903

- A Vehicle without stability control skidding off its intended route.
- B Vehicle with stability control maintaining control on a slippery surface.

## USING STABILITY CONTROL

### AdvanceTrac® with Roll Stability Control™ (RSC®)

The system automatically activates when you start your vehicle. The AdvanceTrac with RSC system cannot be completely turned off, but the electronic stability control and roll stability control portions of the system are disabled when the transmission is in position **R**. You can turn off the traction control portion of the system independently. See **Using Traction Control** (page 188).

## Terrain Response (If Equipped)

### USING TERRAIN RESPONSE

The terrain management system optimizes drivability and comfort as well as maximizing traction while operating on different types of terrain.

Turn the control located on the center console to choose between the following modes:

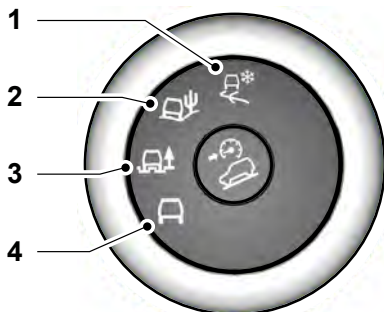

E193313

- 1 **Grass/Gravel/Snow** mode should be selected where a firm surface is covered with loose or slippery material such as packed snow, ice, water, grass, or a thin layer of gravel or sand. For deep gravel or sand, select Sand mode. If the vehicle cannot gain traction in deep snow, switching off the traction control system may help (switch traction control back on when you regain traction). See **Using Traction Control** (page 188).
- 2 **Sand** mode should be selected in soft dry sand or deep gravel. If crossing wet sand that may be sufficiently deep enough for the wheels to sink into the surface, select Mud/Ruts mode.

- 3 **Mud/Ruts** mode should be selected for muddy, rutted, soft or uneven terrain.
- 4 **Normal** mode is for on-road conditions and should be selected before driving on surfaces which are similar to a hard road surface or once the need for a special mode has passed. Select Normal mode when towing a trailer.

**Note:** The Sand and Mud/Ruts modes are for off-road use only.

**Note:** The curve control portion of the AdvanceTrac® system is unavailable when you select Sand or Mud/Ruts.

If the system becomes inoperable, selecting some modes may not be possible and a message displays. If it becomes inoperable due to a system malfunction, all of the mode indicators on the control turn off and one of the following messages appears in the information display:

#### TERRAIN MANAGEMENT SYSTEM

**FAULT:** Cycling the key may clear the fault. If key cycling does not work, have the system serviced by an authorized dealer.

**MODE CHANGE NOT ACCEPTED, RETRY:** A mode change cannot be made at the time of driver request. Try the mode change again.

# Terrain Response (If Equipped)

## USING HILL DESCENT CONTROL

### Principle of operation

#### WARNINGS



Hill descent control cannot control descent in all surface conditions and circumstances, such as ice or extremely steep grades. Hill descent control is a driver assist system and cannot substitute for good judgment by the driver. Failure to do so may result in loss of vehicle control, crash or serious injury.



Hill descent control does not provide hill hold at zero miles per hour (0 kilometers per hour). When stopped, the parking brake must be applied or the vehicle must be placed in **P** (Park) or it may roll away.

Hill descent control allows the driver to set and maintain vehicle speed while descending steep grades in various surface conditions.

Hill descent control can maintain vehicle speeds on downhill grades between 3 mph (5 km/h) and 20 mph (32 km/h). Above 20 mph (32 km/h), the system remains armed, but descent speed cannot be set or maintained.

Hill descent control requires a cooling down interval after a period of sustained use. The amount of time that the feature can remain active before cooling varies with conditions. The system provides a warning in the message center and a chime sounds when the system is about to disengage for cooling. At this time, manually apply the brakes as needed to maintain descent speed.

### Using hill descent control



Press and release the hill descent button located in the center of the terrain management control. A light in the control illuminates and a chime sounds when this feature activates.

To increase descent speed, press the accelerator pedal until you reach the desired speed. To decrease descent speed, press the brake pedal until you reach the desired speed.

Whether accelerating or decelerating, once you reach the desired descent speed, remove your feet from the pedals and hill descent control maintains the chosen vehicle speed.

**Note:** *You may observe noise from the ABS pump motor during hill descent control operation. This is a normal characteristic of the ABS and should be no reason for concern.*

### Hill descent modes

- At speeds below 20 mph (32 km/h): When you press the Hill Descent Control and Hill Descent Control activates, **HILL DESCENT CONTROL ACTIVE** appears in the message center for several seconds.
- At speeds below 20 mph (32 km/h): When you press the Hill Descent Control switch and conditions are not correct for hill descent activation, the Hill Descent Control system enables, the light on the button is solid and **HILL DESCENT CONTROL READY** displays in the message center for several seconds.

## Terrain Response (If Equipped)

---

- At speeds above 20 mph (32 km/h):  
When you press the Hill Descent Control switch, the Hill Descent Control system enables, the light on the button illuminates and **FOR HILL CNTRL, 20 MPH OR LESS** displays in the message center for several seconds.
- For Hill Descent Control to enable, the vehicle must be in a drive gear or (R) Reverse. If the vehicle is in P (Park) or N (Neutral) and you press the button, **FOR HILL CNTRL, SELECT GEAR** displays in the message center for several seconds.

Refer to the Information Displays for additional Hill Descent Control messages. See **Information Messages** (page 113).

# Parking Aids

## PRINCIPLE OF OPERATION

### WARNINGS



To help avoid personal injury, please read and understand the limitations of the system as contained in this section. Sensing is only an aid for some (generally large and fixed) objects when moving on a flat surface at parking speeds. Certain objects with surfaces that absorb ultrasonic waves, surrounding vehicle's parking aid systems, traffic control systems, fluorescent lamps, inclement weather, air brakes, and external motors and fans may also affect the function of the sensing system; this may include reduced performance or a false activation.



To help avoid personal injury, always use caution when in reverse (R) and when using the sensing system.



This system is not designed to prevent contact with small or moving objects. The system is designed to provide a warning to assist the driver in detecting large stationary objects to avoid damaging your vehicle. The system may not detect smaller objects, particularly those close to the ground.



Certain add-on devices such as large trailer hitches, bike or surfboard racks and any device that may block the normal detection zone of the system, may create false beeps.

**Note:** *Keep the sensors, located on the bumper or fascia, free from snow, ice and large accumulations of dirt. If the sensors are covered, the system's accuracy can be affected. Do not clean the sensors with sharp objects.*

**Note:** *If your vehicle sustains damage to the bumper or fascia, leaving it misaligned or bent, the sensing zone may be altered causing inaccurate measurement of obstacles or false alarms.*

**Note:** *The sensing system cannot be turned off when a MyKey is present. See **Principle of Operation** (page 54).*

**Note:** *If you attach certain add-on devices such as a trailer or bike rack, the rear sensing system may detect that add-on device and therefore provide warnings. It is suggested that you disable the rear sensing system when you attach an add-on device to your vehicle to prevent these warnings.*

The sensing system warns the driver of obstacles within a certain range of your vehicle. The system turns on automatically whenever you switch the ignition on.



You can turn the system on or off by pressing the parking aid button. If your vehicle does not have a parking aid button, the system can be switched off through the information display menu or from the pop-up message that appears once you shift the transmission into reverse (R). See **General Information** (page 99).

If a fault is present in the system, a warning message appears in the information display. See **Information Messages** (page 113).

## REAR PARKING AID

The rear sensors are only active when the transmission is in reverse (R). As your vehicle moves closer to the obstacle, the rate of the audible warning increases. When the obstacle is less than 12 in (30 cm) away, the warning sounds continuously. If the system detects a stationary or receding object farther than 12 in (30 cm) from the corners of the bumper, the tone sounds for only three seconds. Once the system detects an object approaching, the warning sounds again.



# Parking Aids



E130178

Coverage area of up to 6 ft (1.8 m) from the rear bumper. There may be decreased coverage area at the outer corners of the bumper.

The system detects certain objects while the transmission is in reverse (R) :

- Your vehicle is moving toward a stationary object at a speed of 3 mph (5 km/h) or less.
- Your vehicle is not moving, but a moving object is approaching the rear of your vehicle at a speed of 3 mph (5 km/h) or less.
- Your vehicle is moving at a speed of less than 3 mph (5 km/h) and a moving object is approaching the rear of your vehicle at a speed of less than 3 mph (5 km/h).

The system provides audio warnings only when your vehicle is moving or when your vehicle is stationary and the detected obstacle is less than 12 in (30 cm) away from the bumper.

## Obstacle Distance Indicator (If Equipped)

The system provides obstacle distance indication through the information display. The distance indicator displays when the transmission is in reverse (R).

The indicator displays:

- As the distance to the obstacle decreases the indicator blocks illuminate and move towards the vehicle icon.
- If there is no obstacle detected, the distance indicator blocks are grayed out.

## FRONT PARKING AID

The front sensors are active when the transmission is in any position other than park (P) and your vehicle is traveling at low speed.



E187330

Coverage area of up to 28 in (70 cm) from the front bumper. The coverage area decreases at the outer corners.

When your vehicle approaches an object, a warning tone sounds. When your vehicle moves closer to an object, the warning tone repeat rate increases. The warning tone sounds continuously when an object is 12 in (30 cm) or less from the front bumper.

# Parking Aids

You can switch the system off through the information display menu or from the pop-up message that appears once you shift the transmission into reverse (R). See **General Information** (page 99). If your vehicle has a parking aid button, you can switch the system off by pressing the button.

## Obstacle Distance Indicator (if Equipped)

The system provides obstacle distance indication through the information display.

The indicator displays:

- As the distance to the obstacle decreases the indicator blocks illuminate and move towards the vehicle icon.
- If there is no obstacle detected, the distance indicator blocks are grayed out.

If the transmission is in reverse (R), the front sensing system provides audio warnings when your vehicle is moving and the detected obstacle is moving towards your vehicle. Once the vehicle is stationary, the audio warning will be stopped after 2 seconds. Visual indication is always present in reverse (R).

If the transmission is in drive (D) or any other forward gear (for example, low (L), sport (S) or any forward gear in a manual transmission), the front sensing system provides audio and visual warnings when your vehicle is moving below a speed of 7 mph (12 km/h) and an obstacle is located inside the detection area. Once the vehicle is stationary, the audio warning will be stopped after 2 seconds and the visual indication stops after 4 seconds. If the obstacles detected are within 12 in (30 cm), the visual indication remains on.

If the transmission is in neutral (N), the system provides visual indication only when your vehicle is moving at 7 mph (12 km/h) or below and an obstacle is located inside the detection area. Once your vehicle is stationary, the visual indication will stop after 4 seconds.

## SIDE SENSING SYSTEM

The side sensing system uses the front and rear side sensors to detect and map obstacles that are near to the sides of your vehicle. The side sensors are active when the transmission is in any position other than park (P).

**Note:** *Obstacles that enter the side detection area without being detected and mapped by the front or rear side sensors will not be detected.*



E187810

Coverage area is up to 24 in (60 cm) from the sides of your vehicle.

When the system detects an object close to the side of your vehicle, an audible warning sounds. As the object comes closer to the side of your vehicle, the rate of the audible warning increases. The rate of the audible warning varies depending on whether the obstacle is inside or outside of the driving path of your vehicle.

# Parking Aids

## Obstacle Distance Indicator (if

Equipped)



E190459

The system provides obstacle distance indication through the information display.

As the distance to the obstacle decreases, the indicator blocks illuminate and move toward the vehicle icon. If there is no obstacle detected, the distance indicator blocks show greyed out.

When you shift to reverse (R), the side sensing system provides audible and visual distance indication when your vehicle is moving and obstacles are detected within 12 in (30 cm), or when obstacles are detected within 12–24 in (30–60 cm) and are inside the driving path of your vehicle. When you stop your vehicle the audible warning stops after two seconds.

**Note:** Visual distance indication remains on when the transmission is in reverse (R).

When you shift to drive (D) or any other forward gear, for example, low (L), sport (S) or any forward gear in manual transmission, the side sensing system provides audible and visual distance indication when your vehicle is moving at 7 mph (12 km/h) or below and obstacles are detected within 12 in (30 cm), or when obstacles are detected within 12–24 in (30–60 cm) and are inside the driving path of your vehicle. When you stop your vehicle the audible warning stops after 2 seconds and the visual distance indication stops after 4 seconds.

**Note:** If the obstacle remains within 12 in (30 cm) visual distance indication remains on.

If the transmission is in neutral (N), the side sensing system only provides visual distance indication when your vehicle is moving at 7 mph (12 km/h) or below, for example when moving on a slope, and obstacles are detected within 12 in (30 cm). When you stop your vehicle the visual distance indication stops after 4 seconds.

If the side sensing system is not available, the side distance indicator blocks will not be present.

The side sensing system is not available under the following condition:

- If you switch the traction control system off.

The side sensing system may not be available until you have driven approximately the length of your vehicle in order for the system to reinitialize if:

- You switch the ignition on, off and back on.
- Your vehicle remains stationary for over two minutes.

# Parking Aids

- The anti-lock brake system is activated.
- The traction control system is activated.

## ACTIVE PARK ASSIST (If Equipped)

### Parallel Parking, Perpendicular Parking, Park Out Assist

#### WARNINGS



You must remain in your vehicle when the system turns on. You are responsible at all times for controlling your vehicle, supervising the system and intervening if required. Failure to take care may result in the loss of control of your vehicle, serious personal injury or death.



The sensors may not detect objects in heavy rain or other conditions that cause disruptive reflections.



Active Park Assist does not apply the brakes under any circumstances.

**Note:** *The driver is always responsible for controlling the vehicle, supervising the system and intervening if required by grabbing the steering wheel or pushing the active park assist button.*

The system detects an available parallel or perpendicular parking space and automatically steers your vehicle into the space (hands-free) while you control the accelerator, gearshift and brakes. The system visually and audibly guides you to park your vehicle.

If you are uncomfortable with the proximity to any vehicle or object, you may choose to override the system.

Park Out Assist automatically steers your vehicle out of a parallel parking space (hands-free) while you control the accelerator, gearshift and brakes. The system visually and audibly guides you to enter traffic.

**Note:** *The Blind Spot Information System does not detect traffic alongside or behind your vehicle during a park assist maneuver.*

The system may not correctly operate in any of the following conditions:

- You use a spare tire or a tire significantly worn more than the other tires.
- One or more tires are improperly inflated.
- You try to park on a tight curve.
- Something passes between the front bumper and the parking space (a pedestrian or cyclist).
- The edge of the neighboring parked vehicle is high off the ground (for example, a bus, tow truck or flatbed truck).
- The weather conditions are poor (heavy rain, snow, fog, etc).

**Note:** *Keep the sensors, located on the bumper or fascia, free from snow, ice and large accumulations of dirt. Covered sensors can affect the system's accuracy. Do not clean the sensors with sharp objects.*

**Note:** *The sensors may not detect objects with surfaces that absorb ultrasonic waves or cause ultrasonic interference (motorcycle exhaust, truck air brakes or horns).*

Do not use the system if:

- You have attached a bike rack, trailer or other object near the sensors on the front or rear of your vehicle.
- You have attached an overhanging object (surfboard) to the roof.

# Parking Aids

- A foreign object damages or obstructs the front or rear bumper or side sensors.
- The correct tire size is not in use on your vehicle (for example, a mini-spare tire).

## Using Active Park Assist - Parallel Parking



Press the button located on the center console near the gearshift lever or the right side of the center stack once.

When driving at a speed less than 22 mph (35 km/h) the system automatically scans both sides of your vehicle for an available parking space. The system displays a message and a corresponding graphic to indicate it is searching for a parking space. Use the direction indicator to select searching either to the left-hand side or right-hand side of your vehicle. If the direction indicators are not used, the system defaults to the passenger side of your vehicle.



E130107

**Note:** You can also activate the Active Park Assist system after you have already driven partially or completely past a parking space. To do so, press the Active Park button and the system will inform you if you have recently passed a suitable parking space.

When the system finds a suitable space, it displays a message and a tone sounds. Stop your vehicle and follow the instructions on the screen. If your vehicle is moving very slowly, you may need to pull forward a short distance before the system is ready to park.

**Note:** You must observe that the selected space remains clear of obstructions at all times during the maneuver.

**Note:** You should drive your vehicle within 5 ft (1.5 m) and as parallel as possible to the other vehicles while passing a parking space.

**Note:** The system always offers the last detected parking space (for example, if your vehicle detects multiple spaces while you are driving, it offers the last one).

**Note:** If driven above approximately 22 mph (35 km/h), the system shows a message to alert you to reduce your vehicle speed.

## Automatic Steering into Parking Space

**Note:** If your vehicle speed exceeds approximately 6 mph (10 km/h) or the maneuver is interrupted (driver input), the system switches off and you need to take full control of your vehicle.

When you shift the transmission into reverse (R), with your hands off the wheel (and nothing obstructing its movement), your vehicle steers itself into the space. The system displays instructions to move your vehicle back and forth in the space.

# Parking Aids



E130108

When you think your vehicle is properly parked, or you hear a solid tone from the parking aid (accompanied by a display message and a chime), bring your vehicle to a complete stop.

When automatic steering is complete, the system displays a message and a tone sounds, indicating that the active park assist process is finished. You are responsible for checking the parking job and making any necessary corrections before leaving your vehicle.

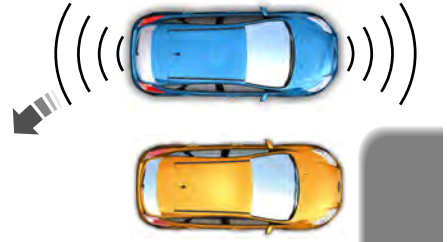

## Using Active Park Assist - Perpendicular Parking



Press the button located on the center console near the gearshift lever or the right side of the center stack twice.

The system displays a message and a corresponding graphic to indicate it is searching for a parking space. Use the direction indicator to select searching either to the left-hand side or right-hand side of your vehicle.

**Note:** If you do not make a selection the system will default to the passenger's side.

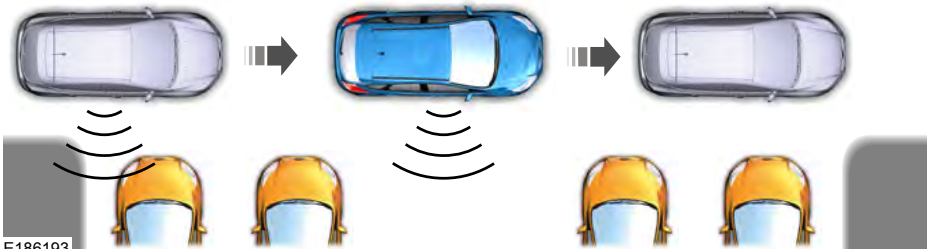

E186193

When the system finds a suitable space, it displays a message and a tone sounds. Stop your vehicle and follow the instructions on the screen. If your vehicle is moving very slowly, you may need to pull forward a short distance before the system is ready to park.

**Note:** You must observe that the selected space remains clear of obstructions at all times during the maneuver.

**Note:** You should drive your vehicle within 5 ft (1.5 m) and as perpendicular as possible to the other vehicles while passing a parking space.

# Parking Aids

**Note:** The system always offers the last detected parking space (for example, if your vehicle detects multiple spaces while you are driving, it offers the last one).

**Note:** If driven above approximately 19 mph (30 km/h), the system shows a message to alert you to reduce your vehicle speed.

## Automatic Steering into Parking Space

**Note:** If your vehicle speed exceeds 6 mph (10 km/h) or the maneuver is interrupted (driver input), the system switches off and you need to take full control of your vehicle.

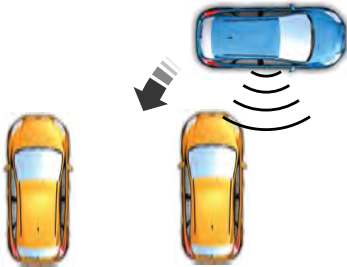

E186191

When you shift the transmission into reverse (R), with your hands off the wheel (and nothing obstructing its movement), your vehicle steers itself into the space. The system displays instructions to move your vehicle back and forth in the space.

When you think your vehicle is properly parked, or you hear a solid tone from the parking aid (accompanied by a display message and a chime), bring your vehicle to a complete stop.

When automatic steering is complete, the system displays a message and a tone sounds, indicating that the active park assist process is finished. You are responsible for checking the parking job and making any necessary corrections before leaving your vehicle.

## Using Active Park Assist - Park Out Assist



While your vehicle is at rest in a parallel parking space, press the active park assist button.

The system displays a message requesting an indication of direction. Use the direction indicator to signal which side of your vehicle you want to exit the parking space.

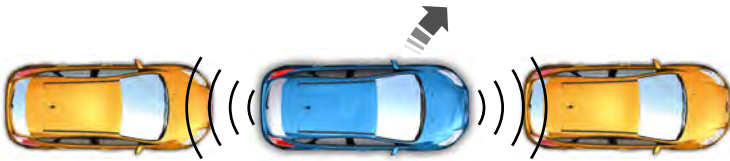

E188012

# Parking Aids

The system determines the clearance to the front and rear of your vehicle and automatically steers your vehicle out of a parallel parking space (hands-free) while you control the accelerator, gearshift and brakes. The system visually and audibly guides you to enter traffic.

After the system has directed your vehicle past the adjacent vehicle or object, it guides you to take control of the steering to complete the exit from the parking spot.

**Note:** *If the clearance in front of your vehicle allows easy departure, the Park Out Assist feature might not be available.*

**Note:** *You are responsible for controlling your vehicle and making sure the path is clear prior to pulling into traffic.*

**Note:** *This system is not intended to assist in exiting perpendicular parking spaces, damages to your vehicle may occur.*

**Note:** *If your vehicle speed exceeds 3 mph (5 km/h) or the maneuver is interrupted (driver input), the system switches off and you need to take full control of your vehicle.*

## Deactivating the Active Park Assist Feature

Manually deactivate the system by:

- Pressing the active park assist button during an active maneuver.
- Grabbing the steering wheel during an active maneuver.
- Driving above approximately 22 mph (35 km/h) for 30 seconds during an active park search.
- Driving above approximately 6 mph (10 km/h) during automatic steering.
- Switching off the traction control system.

Certain vehicle conditions can also deactivate the system, such as:

- Traction control has activated.
- There is an anti-lock brake system activation or failure.

If a problem occurs with the system, a warning message displays accompanied by a tone. Occasional system messages may occur in normal operation. For recurring or frequent system faults, contact an authorized dealer to have your vehicle serviced.

## Troubleshooting the System

| The system does not look for a space  |
|---|
| The traction control system may be off.   |
| The transmission is in reverse (R). Your vehicle must be moving forward to be able to detect a parking space. |



# Parking Aids

## The system does not offer a particular space

The sensors may be covered (for example, snow, ice or dirt buildup). Covered sensors can affect the system's functionality.

There is not enough room in the parking space for your vehicle to safely park.

There is not enough space for the parking maneuver on the opposite side of the parking space.

The parking space is farther than 5 ft (1.5 m) or closer than 16 in (0.4 m) away.

Your vehicle is going faster than 22 mph (35 km/h) for parallel and 19 mph (30 km/h) for perpendicular parking.

## The system does not position the vehicle where I want in the space

Your vehicle is rolling in the opposite direction of the transmission (rolling forward with reverse [R] selected).

An irregular curb along the parking space prevents the system from aligning your vehicle properly.

Vehicles or objects bordering the space may not be positioned correctly.

You pulled your vehicle too far past the parking space.

The tires may not be installed or maintained correctly (not inflated correctly, improper size, or of different sizes).

A repair or alteration has changed detection capabilities.

A parked vehicle has a high attachment (salt sprayer, snowplow or moving truck bed).

The parking space length or position of parked objects changed after your vehicle passed.

The temperature around your vehicle changes quickly (driving from a heated garage into the cold, or after leaving a car wash).

## REAR VIEW CAMERA

### WARNINGS



The rear view camera system is a reverse aid supplement device that still requires the driver to use it in conjunction with the interior and exterior mirrors for maximum coverage.

### WARNINGS



Objects that are close to either corner of the bumper or under the bumper, might not be seen on the screen due to the limited coverage of the camera system.



Back up as slow as possible since higher speeds might limit your reaction time to stop your vehicle.

# Parking Aids

## WARNINGS



Use caution when using the rear video camera and the luggage compartment door is ajar. If the luggage compartment door is ajar, the camera will be out of position and the video image may be incorrect. All guidelines disappear when the luggage compartment door is ajar.



Use caution when turning camera features on or off. Make sure your vehicle is not moving.

The rear view camera system provides a video image of the area behind your vehicle.

During operation, lines appear in the display which represent your vehicle's path and proximity to objects behind your vehicle.



E142435

The camera is located on the luggage compartment door.

## Using the Rear View Camera System

The rear view camera system displays what is behind your vehicle when you place the transmission in reverse (R).

**Note:** *The reverse sensing system is not effective at speeds above 3 mph (5 km/h) and may not detect certain angular or moving objects.*

The system uses three types of guides to help you see what is behind your vehicle:

- Active guidelines (if equipped): Show the intended path of your vehicle when reversing.
- Fixed guidelines: Show the actual path your vehicle is moving in while reversing in a straight line. This can be helpful when backing into a parking space or aligning your vehicle with another object behind you.
- Centerline: Helps align the center of your vehicle with an object (for example, a trailer).

**Note:** *If the transmission is in reverse (R) and the luggage compartment door or liftgate is open, no rear view camera features will display.*

**Note:** *When towing, the camera only sees what you are towing. This might not provide adequate coverage as it usually provides in normal operation and some objects might not be seen. In some vehicles, the guidelines may disappear when you connect the trailer tow connector.*

The camera may not operate correctly under the following conditions:

- Nighttime or dark areas if one or both reverse lamps are not operating.
- Mud, water or debris obstructs the camera's view. Clean the lens with a soft, lint-free cloth and non-abrasive cleaner. You can also use the rear washer to clean the camera. See **Rear Window Wiper and Washers** (page 77).
- The rear of your vehicle is hit or damaged, causing the camera to become misaligned.

# Parking Aids

## Camera Guidelines

**Note:** Active guidelines are only available when the transmission is in reverse (R).

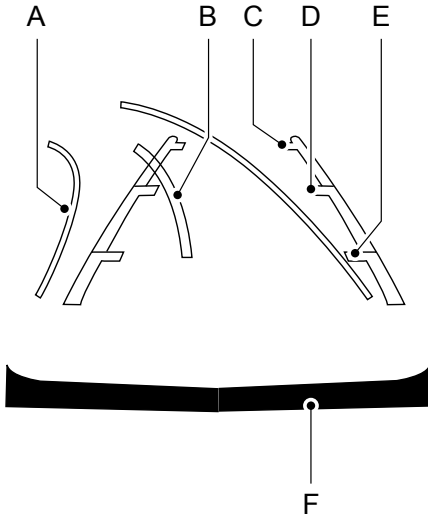

E142436

- A Active guidelines (If equipped)
- B Centerline
- C Fixed guideline: Green zone
- D Fixed guideline: Yellow zone
- E Fixed guideline: Red zone
- F Rear bumper

Active guidelines are only shown with fixed guidelines. To use active guidelines, turn the steering wheel to point the guidelines toward an intended path. If you change the steering wheel position while reversing, your vehicle might deviate from the original intended path.

The fixed and active guidelines fade in and out depending on the steering wheel position. The active guidelines do not display when the steering wheel position is straight.

Always use caution while reversing. Objects in the red zone are closest to your vehicle and objects in the green zone are farther away. Objects are getting closer to your vehicle as they move from the green zone to the yellow or red zones. Use the side view mirrors and rear view mirror to get better coverage on both sides and rear of the vehicle.

## Manual Zoom

### WARNING



When manual zoom is on, the full area behind your vehicle may not show. Be aware of your surroundings when using the manual zoom feature.

**Note:** Manual zoom is only available when the transmission is in reverse (R).

**Note:** When you enable manual zoom, only the centerline is shown.

Selectable settings for this feature are Zoom in (+) and Zoom out (-). Press the symbol in the camera screen to change the view. The default setting is Zoom OFF.

This allows you to get a closer view of an object behind your vehicle. The zoomed image keeps the bumper in the image to provide a reference. The zoom is only active while the transmission is in reverse (R).

## Camera System Settings

The rear view camera system settings can be accessed through the display screen. See **General Information** (page 99).

# Parking Aids

## Enhanced Park Aids or Park Pilot

Selectable settings for this feature are ON and OFF.

The system uses red, yellow and green highlights that appear on top of the video image when any of the sensing systems detect an object.

## Vehicles equipped with MyFord Touch™

The system will provide an image of your vehicle and the sensor zones. The zones will highlight green, yellow and red when the parking aid sensors detect an object in the coverage area.

The coverage area is up to 6 ft (1.8 m) from the rear bumper. There is decreased coverage area at the outer corners of the bumper.



E130178

For additional information of the zone coverage and the rear sensing system. See **Rear Parking Aid** (page 194).

## Rear Camera Delay

Selectable settings for this feature are ON and OFF.

The default setting for the rear camera delay is OFF.

When shifting the transmission out of reverse (R) and into any gear other than park (P), the camera image remains in the display until:

- Your vehicle speed reaches approximately 5 mph (8 km/h).
- You shift your vehicle into park (P).

## 180 DEGREE CAMERA

### WARNINGS

 The camera system is a supplement system that still requires the driver to use it in conjunction with looking out the windows, and checking the interior and exterior mirrors for maximum coverage.

 You may not see objects that are close to either corner of the bumper or under the bumper due to the limited coverage of the camera system.

 Use caution when turning camera features ON or OFF while out of park (P). Make sure your vehicle is not moving.

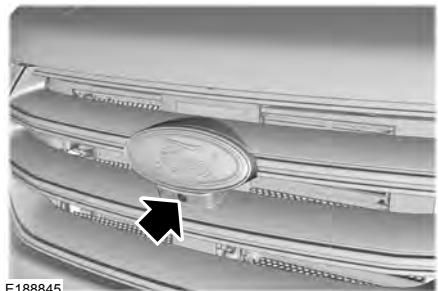

E188845

The front view camera is located in the grille.

The front view camera provides a video image of the area in front of your vehicle.

# Parking Aids

---

**Note:** The area displayed on the screen may vary according to your vehicle's orientation or road condition.

**Note:** The front view camera will switch off if your vehicle speed exceeds 6 mph (10 km/h). You will have to switch the system back on by using the camera system button once below the speed threshold.

**Note:** Additional camera information can be found in the rear view camera section. See **Rear View Camera** (page 203).

## Using the 180 degree camera system

The 180 degree camera system consists of front and rear cameras. The system:

- Allows you to see what is directly in front or behind your vehicle.
- Provides cross traffic view in front and behind your vehicle.
- Provides visibility during parking maneuvers.



The camera system button is located on the audio unit and allows you to toggle through different camera views.

**Note:** The camera system may not operate correctly if mud, water or debris obstructs the camera's view. You can clean the lens with a soft, lint-free cloth and non-abrasive cleaner or by using your front or rear washer. See **Wipers and Washers** (page 76).

## Camera Views

Press the camera button to toggle between different views.

- **Normal Rear View:** Provides an image of what is directly behind your vehicle when your vehicle is in reverse (R).
- **Expanded Rear View:** Provides an expanded 180 degree image of what is directly behind your vehicle when your vehicle is in reverse (R).

- **Normal Front View:** Provides an image of what is directly in front your vehicle when your vehicle is in neutral (N) or drive (D).
- **Expanded Front View:** Provides an expanded 180 degree image of what is directly in front your vehicle when your vehicle is in neutral (N) or drive (D).

# Cruise Control

## PRINCIPLE OF OPERATION

Cruise control lets you maintain a set speed without keeping your foot on the accelerator pedal. You can use cruise control when your vehicle speed is greater than 20 mph (30 km/h).

## USING CRUISE CONTROL

### WARNINGS



Do not use cruise control on winding roads, in heavy traffic or when the road surface is slippery. This could result in loss of vehicle control, serious injury or death.



When you are going downhill, your vehicle speed may increase above the set speed. The system will not apply the brakes but a warning displays.



E200995

The cruise controls are on the steering wheel.

## Switching Cruise Control On

Press and release **ON**.



The indicator appears in the instrument cluster.

## Setting the Cruise Speed

1. Drive to desired speed.
2. Press and release **SET+**.
3. Take your foot off the accelerator pedal.

**Note:** *The indicator will change color.*

**Note:** *Cruise control disengages if the vehicle speed decreases more than 10 mph (16 km/h) below the set speed while driving uphill.*

## Changing the Set Speed

- Press and release **SET+** or **SET-**. When you select kph as the display measurement in the information display, the set speed changes in approximately 2 kph increments. When you select mph as the display measurement in the information display, the set speed changes in approximately 1 mph increments.
- Press the accelerator or brake pedal until you reach the desired speed. Press and release **SET+**.
- Press the **SET+** or **SET-** button to change the set speed in increments of approximately 1 mph or 2 km/h.
- Hold the **SET+** or **SET-** button to change the set speed in increments of approximately 5 mph or 10 km/h.

**Note:** *If you accelerate by pressing the accelerator pedal, the set speed will not change. When you release the accelerator pedal, your vehicle returns to the speed that you previously set.*

## Canceling the Set Speed

Press and release **CAN** or tap the brake pedal. You will not erase the set speed.

## Resuming the Set Speed

Press and release **RES**.

# Cruise Control

## Switching Cruise Control Off

Press and release **OFF** when the system is in stand by mode or switch the ignition off.

**Note:** *You erase the set speed when you switch the system off.*

## USING ADAPTIVE CRUISE CONTROL (If Equipped)

### WARNINGS

 Always pay close attention to changing road conditions when using adaptive cruise control. The system does not replace attentive driving. Failing to pay attention to the road may result in a crash, serious injury or death.

 Adaptive cruise control is not a crash warning or avoidance system.

 Adaptive cruise control does not detect stationary or slow moving vehicles below 6 mph (10 km/h).

 Adaptive cruise control does not detect pedestrians or objects in the road.

 Adaptive cruise control does not detect oncoming vehicles in the same lane.

 Do not use adaptive cruise control on winding roads, in heavy traffic or when the road surface is slippery. This could result in loss of vehicle control, serious injury or death.

 Do not use adaptive cruise control when towing a trailer that has trailer brakes. The auto-brake component of the adaptive cruise control system does not operate the trailer brakes. Using adaptive cruise control when towing a trailer that has trailer brakes may result in the loss of vehicle control, which could result in serious injury.

### WARNINGS

 Do not use tire sizes other than those recommended because this can affect the normal operation of the system. Failing to do so may result in a loss of vehicle control, which could result in serious injury.

The system adjusts your vehicle speed to maintain the set gap between you and the vehicle in front of you in the same lane.



E200996

The adaptive cruise controls are on the steering wheel.

## Switching Adaptive Cruise Control On

Press and release **ON**.



The indicator appears in the instrument cluster.

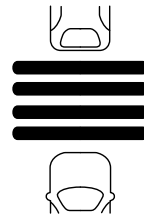

E164805

The current gap setting and **SET** will also appear.

# Cruise Control

## Setting the Adaptive Cruise Speed

1. Drive to desired speed.
2. Press and release **SET+**.
3. A green indicator light, current gap setting and your desired set speed appear in the instrument cluster.
4. Take your foot off the accelerator pedal.

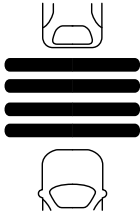

E164805

5. A vehicle graphic illuminates if there is a vehicle detected in front of you.

**Note:** When adaptive cruise control is active, the speedometer may vary slightly from the set speed displayed in the information display.

## Following a Vehicle

### WARNINGS



When following a vehicle, your vehicle does not decelerate automatically to a stop, nor does your vehicle always decelerate quickly enough to avoid a crash without driver intervention. Always apply the brakes when necessary. Failing to do so may result in a crash, serious injury or death.



Adaptive cruise control only warns of vehicles detected by the radar sensor. In some cases there may be no warning or a delayed warning. You should always apply the brakes when necessary. Failure to do so may result in a crash, serious injury or death.

**Note:** The brakes may emit noise when applied by the system.

When a vehicle ahead of you enters the same lane or a slower vehicle is ahead in the same lane, the vehicle speed adjusts to maintain a preset gap distance.

A vehicle graphic illuminates in the instrument cluster.

Your vehicle will maintain a constant gap from the vehicle ahead until:

- The vehicle in front of you accelerates to a speed above the set speed.
- The vehicle in front of you moves out of the lane you are in.
- Your vehicle speed falls below 12 mph (20 km/h).
- You set a new gap distance.

The system applies the brakes to slow your vehicle to maintain a safe gap distance from the vehicle in front. The brake lamps automatically turn on when the system applies the brakes. The maximum braking which the system applies is limited. You can override the system by applying the brakes.

If the system determines that its maximum braking level will not be sufficient, an audible warning sounds while the system continues to brake. A red warning bar displays on the windshield and you must take immediate action.

**Note:** When you are following a vehicle and you switch on a direction indicator, adaptive cruise control may provide a small temporary acceleration to help you pass.

## Setting the Gap Distance

You can decrease or increase the gap between your vehicle and the vehicle in front of you by pressing the gap control. You can select four gap settings.

**Note:** It is your responsibility to select a gap appropriate to the driving conditions.



# Cruise Control

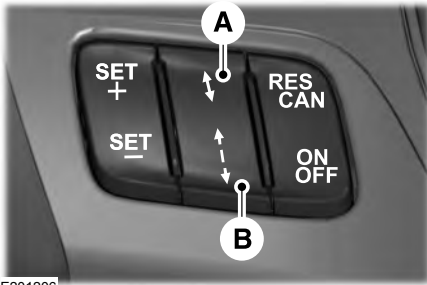

E201206

- A Gap decrease.
- B Gap increase.

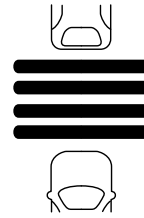

E164805

The selected gap appears in the information display as shown by the bars in the graphic. Five gap settings are available.

The gap setting is time dependent and the distance automatically adjusts with your vehicle speed.

## Adaptive cruise control gap settings

| Set speed<br>mph ( km/h) | Graphic display,<br>bars indicated<br>between<br>vehicles | Time gap,<br>seconds | Gap<br>yd ( m) | Dynamic beha-<br>vior |
|--------------------------|---|----------------------|----------------|-----------------------|
| 62 (100)                 | 1   | 1                    | 31 (28)        | Sport                 |
| 62 (100)                 | 2   | 1.4                  | 43 (39)        | Normal                |
| 62 (100)                 | 3   | 1.8                  | 55 (50)        | Normal                |
| 62 (100)                 | 4   | 2.2                  | 67 (61)        | Comfort               |

Each time you start the vehicle, the system selects the last chosen gap.

### Canceling the Set Speed

Press and release **CAN** or tap the brake pedal. The set speed does not erase.

### Overriding the System

#### WARNING



Whenever the driver is overriding the system by pressing the accelerator pedal, the system does not automatically apply the brakes to maintain separation from any vehicle ahead.

You can override the set speed and gap by pressing the accelerator pedal.



When you override the system, the green indicator light illuminates and the lead vehicle graphic does not show in the information display.

The system resumes operation when you release the accelerator pedal. The vehicle speed decreases to the set speed, or a lower speed if following a slower vehicle.

# Cruise Control

## Changing the Set Speed

- Press and release **SET+** or **SET-**. When you select km/h as the display measurement in the information display the set speed changes in approximately 2 km/h increments. When you select mph as the display measurement in the information display the set speed changes in approximately 1 mph increments.
- Press the accelerator or brake pedal until you reach the desired speed. Press and release **SET+**.
- Press and hold **SET+** or **SET-** until the desired set speed shows on the information display. The vehicle speed will gradually change to the selected speed.

The system may apply the brakes to slow the vehicle to the new set speed. The set speed displays continuously in the information display while the system is active.

## Resuming the Set Speed

Press and release **RES**. The vehicle returns to the previously set speed and gap setting. The set speed displays continuously in the information display while the system is active.

**Note:** Only use resume if you are aware of the set speed and intend to return to it.

## Automatic Cancellation

The system does not operate below 12 mph (20 km/h). An audible warning sounds and the automatic braking releases if the vehicle drops below this speed.

## Hilly Condition Usage

You should select a lower gear position when the system is active in situations such as prolonged downhill driving on steep grades, for example in mountainous areas. The system needs additional engine braking in these situations to reduce the load on the vehicle's regular brake system to prevent them from overheating.

**Note:** An audible warning sounds and the system shuts down if it applies brakes for an extended period of time. This allows the brakes to cool down. The system functions normally again when the brakes have cooled down.

## Switching Adaptive Cruise Control Off

Press and release the **OFF** button when the system is in stand by mode or switch the ignition off.

**Note:** The set speed memory erases when you switch off the system.

## Detection Issues

### WARNING



On rare occasions, detection issues can occur due to the road infrastructures, for example bridges, tunnels and safety barriers. In these cases, the system may brake late or unexpectedly. At all times, you are responsible for controlling your vehicle, supervising the system and intervening, if required.

The radar sensor has a limited field of vision. It may not detect vehicles at all or detect a vehicle later than expected in some situations. The lead vehicle graphic does not illuminate if the system does not detect a vehicle in front of you.

# Cruise Control

**A**

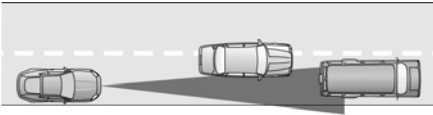

**B**

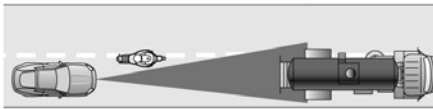

**C**

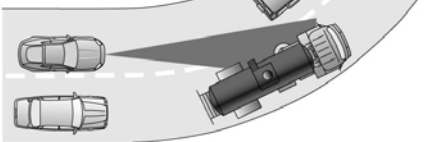

E71621

Detection issues can occur:

- A When driving on a different line than the vehicle in front.
- B With vehicles that edge into your lane. The system can only detect these vehicles once they move fully into your lane.
- C There may be issues with the detection of vehicles in front when driving into and coming out of a bend or curve in the road.

In these cases the system may brake late or unexpectedly. The driver should stay alert and intervene when necessary.

If something hits the front of your vehicle or damage occurs, the radar-sensing zone may change. This could cause missed or false vehicle detections. See an authorized dealer to have the radar checked for correct operation.

## System Not Available

Conditions that can cause the system to deactivate or prevent the system from activating when requested include:

- A blocked sensor.
- High brake temperature.
- A failure in the system or a related system.

## Blocked Sensor



E145632

A message displays if something obstructs the radar signals from the sensor. The sensor is located on the lower grille. The system cannot detect a vehicle ahead and does not function when something obstructs the radar signals.

# Cruise Control

The following table lists possible causes and actions for this message displaying.

| Cause   | Action   |
|---|--|
| The surface of the radar in the grille is dirty or obstructed in some way.                      | Clean the grille surface in front of the radar or remove the object causing the obstruction.             |
| The surface of the radar in the grille is clean but the message remains in the display.         | Wait a short time. It may take several minutes for the radar to detect that it is free from obstruction. |
| Heavy rain or snow is interfering with the radar signals.                                       | Do not use the system in these conditions because it may not detect any vehicles ahead.                  |
| Swirling water, or snow or ice on the surface of the road may interfere with the radar signals. | Do not use the system in these conditions because it may not detect any vehicles ahead.                  |
| You are in a desert or remote area with no other vehicles and no roadside objects.              | Wait a short time or switch to normal cruise control.  |

Due to the nature of radar technology, it is possible to get a blockage warning and not be blocked. This can happen, for example, when driving in sparse rural environments. A false blocked condition self clears or clears after a key cycle.



The cruise control indicator light replaces the adaptive cruise control indicator light if you select normal cruise control. The gap setting does not display, the system does not automatically respond to lead vehicles and automatic braking does not activate.

## Switching to Normal Cruise Control

### WARNING



Normal cruise control does not brake due to slower vehicles. Always be aware of which mode you have selected and apply the brakes when necessary.

You can manually change from adaptive cruise control to normal cruise control through the information display.

# Driving Aids

## DRIVER ALERT (If Equipped)

### PRINCIPLE OF OPERATION

#### WARNING



The driver alert system is designed to aid you. It is not intended to replace your attention and judgment. You are still responsible to drive with due care and attention.

**Note:** The system will store the on or off setting in the information display menu through ignition cycles.

**Note:** If enabled in the menu, the system will be active at speeds above 40 mph (64 km/h). When below the activation speed, the information display will inform the driver that the system is unavailable.

**Note:** The system works as long as one lane marking can be detected by the camera.

**Note:** If the camera is blocked or if the windshield is damaged, the system may not function.

**Note:** The system may not be available in poor weather or other low visibility conditions.

The system automatically monitors your driving behavior using various inputs including the front camera sensor.

If the system detects that your driving alertness is reduced below a certain threshold, the system will alert you using a chime and a message in the cluster display.

### USING DRIVER ALERT

#### Switching the System On and Off

Switch the system on or off using the information display. See **General Information** (page 99).

When activated, the system will monitor your alertness level based upon your driving behavior in relation to the lane markings, and other factors.

#### System Warnings

**Note:** The system will not issue warnings below approximately 40 mph (64 km/h).

The warning system has two stages. At first, the system issues a temporary warning that you need to take a rest. This message will only appear for a short time. If the system detects further reduction in driving alertness, it may issue another warning that will remain in the information display for a longer time. You can press OK on the steering wheel control to clear the warning.

#### Resetting the System

You can reset the system by either:

- Switching the ignition off and on.
- Stopping the vehicle and then opening and closing the driver's door.

## LANE KEEPING SYSTEM (If

Equipped)

#### WARNINGS



Always drive with due care and attention when using and operating the controls and features on your vehicle.



At all times, you are responsible for controlling your vehicle, supervising the system and intervening, if required. Failure to take care may result in the loss of control of your vehicle, serious personal injury or death.



In cold and severe weather conditions the system may not function. Rain, snow and spray can all limit sensor performance.

# Driving Aids

## WARNINGS



Large contrasts in outside lighting can limit sensor performance.



The system will not operate if the sensor cannot track the road lane markings.



If damage occurs in the immediate area surrounding the sensor, have your vehicle checked as soon as possible.

**Note:** The system works above 40 mph (64 km/h).

**Note:** The system works as long as the camera can detect one lane marking.

**Note:** The system may not function if the camera is blocked or there is damage to the windshield.

**Note:** When Aid mode is on and the system detects no steering activity for a short period, the system will alert you to put your hands on the steering wheel. The system may detect a light grip or touch on the steering wheel as hands off driving.

The system notifies you to stay in your lane through the steering system and the instrument cluster display when the front camera detects an unintentional drift out of your lane is likely to occur. The system automatically detects and tracks the road lane markings using a camera mounted behind the interior rear view mirror.

## Switching the System On and Off

**Note:** The system on or off setting is stored until it is manually changed, unless a MyKey is detected. If the system detects a MyKey it defaults to on and the mode is set to Alert.

**Note:** If a MyKey is detected, pressing the button will not affect the on or off status of the system.



Press the button on the steering wheel stalk to switch the system on or off.

## System Settings

The system has optional setting menus available. The system stores the last-known selection for each of these settings. You do not need to readjust your settings each time you turn on the system.

**Mode:** This setting allows you to select which of the system features you can enable.

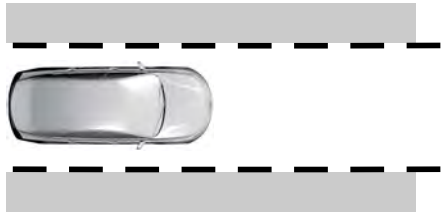

E165515

Alert only – Provides a steering wheel vibration when the system detects an unintended lane departure.

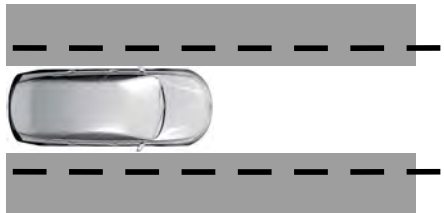

E165516

# Driving Aids

Aid only – Provides an assistance steering torque input toward the lane center when the system detects an unintended lane departure.

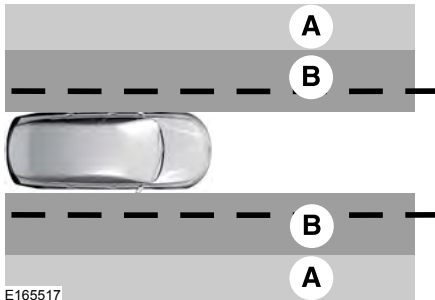

E165517

- A Alert
- B Aid

Alert + Aid – Provides an assistance steering torque input toward the lane center. If your vehicle continues drifting out of the lane, the system provides a steering wheel vibration.

**Note:** *The alert and aid diagrams illustrate general zone coverage. They do not provide exact zone parameters.*

**Intensity:** This setting affects the intensity of the steering wheel vibration used for the alert and alert + aid modes. This setting does not affect the aid mode.

- Low
- Normal
- High

## System Display



E151660

When you switch on the system, an overhead graphic of a vehicle with lane markings will display in the information display. If you select aid mode when you switch on the system, a separate white icon will also appear or in some vehicles arrows will display with the lane markings.

When you switch off the system, the lane marking graphics will not display.

While the system is on, the color of the lane markings will change to indicate the system status.

Gray: Indicates that the system is temporarily unable to provide a warning or intervention on the indicated side(s). This may be because:

- Your vehicle is under the activation speed.
- The turn indicator is active.
- Your vehicle is in a dynamic maneuver.

# Driving Aids

- The road has no or poor lane markings in the camera field-of-view.
- The camera is obscured or unable to detect the lane markings due to environmental conditions (significant sun angles, shadows, snow, heavy rain or fog), traffic conditions (following a large vehicle that is blocking or shadowing the lane), or vehicle conditions (poor headlamp illumination).

See **Troubleshooting** for additional information.

Green: Indicates that the system is available or ready to provide a warning or intervention, on the indicated side(s).

## Troubleshooting

| <b>Why is the feature not available (line markings are gray) when I can see the lane markings on the road?</b> |
|--|
| Vehicle speed is outside the operational range of the feature  |
| Sun is shining directly into the camera lens   |
| Quick intentional lane change  |
| Staying too close to the lane marking  |
| Driving at high speeds in curves   |
| The last Alert warning or Aid intervention occurred a short time ago   |
| Ambiguous lane markings (mainly in construction zones)   |
| Rapid transition from light to dark or vice versa  |
| Sudden offset in lane markings   |
| ABS or AdvanceTrac activation  |
| Camera blockage due to dirt, grime, fog, frost or water on the windshield                                      |
| Driving too close to the vehicle in front of you   |
| Transitioning between no lane markings to lane markings or vice versa  |
| Standing water on the road   |
| Faint lane markings (partial yellow lane markings on concrete roads)   |

Yellow: Indicates that the system is providing or has just provided a lane keeping aid intervention.

Red: Indicates that the system is providing or has just provided a lane keeping alert warning.

The system can be temporarily suppressed at any time by the following:

- Quick braking.
- Fast acceleration.
- Using the turn signal indicator.
- Evasive steering maneuver.



# Driving Aids

**Why is the feature not available (line markings are gray) when I can see the lane markings on the road?**

Lane width too narrow or too wide

Camera not calibrated after a windshield replacement

Driving on tight roads or on uneven roads

**Why does the vehicle not come back toward the middle of the lane, as expected, in the Aid or Aid + Alert mode?**

High cross winds

Large road crown

Rough roads, grooves, shoulder drop-offs

Heavy uneven loading of the vehicle or improper tire inflation pressure

If the tires have been exchanged (including snow tires), or the suspension has been modified

## BLIND SPOT INFORMATION SYSTEM

### WARNING



To help avoid injuries, NEVER use the Blind Spot Information System as a replacement for using the interior and exterior mirrors or looking over your shoulder before changing lanes. The Blind Spot Information System is not a replacement for careful driving.

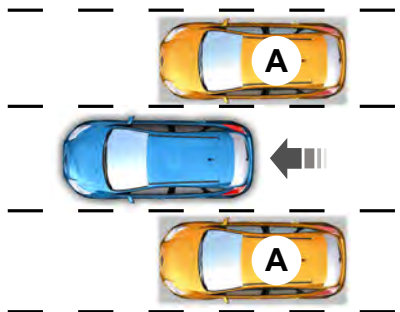

E124788

The Blind Spot Information System is designed to aid you in detecting vehicles that may have entered the blind spot zone (A). The detection area is on both sides of your vehicle, extending rearward from the exterior mirrors to approximately 13 ft (4 m) beyond the bumper. The system is designed to alert you if certain vehicles enter the blind spot zone while driving.

# Driving Aids

**Note:** *The Blind Spot Information System does not prevent contact with other vehicles or objects; nor detect parked vehicles, people, animals or infrastructure (fences, guardrails, trees). It's only designed to alert you to vehicles in the blind spot zones.*

**Note:** *When a vehicle passes quickly through the blind spot zone, typically fewer than two seconds, the system does not trigger.*

## Using the System

The Blind Spot Information System turns on when you start the engine and you drive your vehicle forward above 5 mph (8 km/h).

For automatic transmissions, the Blind Spot Information System remains on while the transmission is in drive (D). If shifted into reverse (R) or park (P) the Blind Spot Information System turns off. Once shifted back into drive (D), the Blind Spot Information System turns back on when you drive your vehicle above 5 mph (8 km/h).

For manual transmissions, the Blind Spot Information System is on for all gears except the reverse (R).

**Note:** *The Blind Spot Information System does not function in reverse (R) or park (P).*

## System Lights and Messages



E142442

The Blind Spot Information System illuminates an amber alert indicator in the outside mirror on the side of your vehicle the approaching vehicle is coming from. When the Blind Spot Information System is alerting on a vehicle and the corresponding turn signal is ON, the Blind Spot Information System alert indicator flashes as an increased warning level.

The alert indicator dims when the system detects nighttime darkness.

**Note:** *The alert indicator flashes in case of an alert and the turn signal is set to that side at the same time.*

## System Sensor Blockage

### WARNING



To help avoid injuries, NEVER use the Blind Spot Information System as a replacement for using the interior and exterior mirrors or looking over your shoulder before changing lanes. The Blind Spot Information System is not a replacement for careful driving.

# Driving Aids

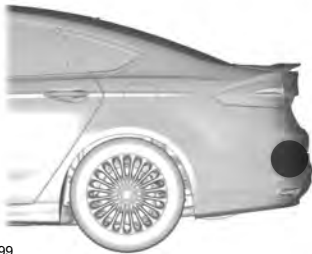

E205199

The system uses radar sensors that are located behind the bumper fascia on each side of your vehicle. Any dirt, mud and snow in front of the sensors and/or driving in heavy rain can cause system degradation. Also, other types of obstructions in front of the sensor can cause system degradation. This is referred to as a 'blocked' condition.

**Note:** Do not apply bumper stickers and/or repair compound to these areas, this can cause degraded system performance.

If the system detects a degraded performance condition, a message warning of a blocked sensor will appear in the information display. Also the BLIS alert indicators will remain ON and BLIS will no longer provide any vehicle warnings. You can clear the information display warning but the alert indicators will remain illuminated.

A "blocked" condition can be cleared in two ways:

- After the blockage in front of the sensors is removed or the rainfall/snowfall rate decreases or stops, drive for a few minutes in traffic to allow the sensors to detect passing vehicles.
- By cycling the ignition from ON to OFF and then back ON.

**Note:** If your vehicle has a tow bar with a factory equipped trailer tow module and it is towing a trailer, the sensors will automatically turn the Blind Spot Information System off. If your vehicle has a tow bar but no factory equipped trailer tow module, it is recommended to turn the Blind Spot Information System off manually. Operating the Blind Spot Information System with a trailer attached will cause poor system performance.

## System Errors

If the system senses a problem with the left or right sensor, the telltale will illuminate and a message will appear in the information display. See **Information Messages** (page 113).

# Driving Aids

---

## Switching the System Off and On

You can temporarily switch the Blind Spot Information System off in the information display. See **General Information** (page 99). When the Blind Spot Information System switches off, you will not receive alerts and the information display shows a system off message. The telltale in the cluster also illuminates. When you switch the Blind Spot Information System on or off, the alert indicators flash twice.

**Note:** *The Blind Spot Information System remembers the last selected on or off setting.*

You can also have the Blind Spot Information System switched off permanently at an authorized dealer. Once switched off permanently, the system can only be switched back on at an authorized dealer.

## CROSS TRAFFIC ALERT

### WARNING



To help avoid personal injury, NEVER use the Cross Traffic Alert system as a replacement for using the interior and exterior mirrors and looking over your shoulder before backing out of a parking space. Cross Traffic Alert is not a replacement for careful driving.

---

Cross Traffic Alert is designed to warn you of vehicles approaching from the sides when the transmission is in reverse (R).

### Using the System

Cross Traffic Alert turns on when you start the engine and you shift into reverse (R). Once shifted out of reverse (R), Cross Traffic Alert turns off.

**Note:** *Cross Traffic Alert only functions while your transmission is in reverse (R).*

Cross Traffic Alert is designed to detect vehicles that approach with a speed up to 37 mph (60 km/h). Coverage decreases when the sensors are partially, mostly or fully obstructed. Reversing slowly helps increase the coverage area and effectiveness.

# Driving Aids

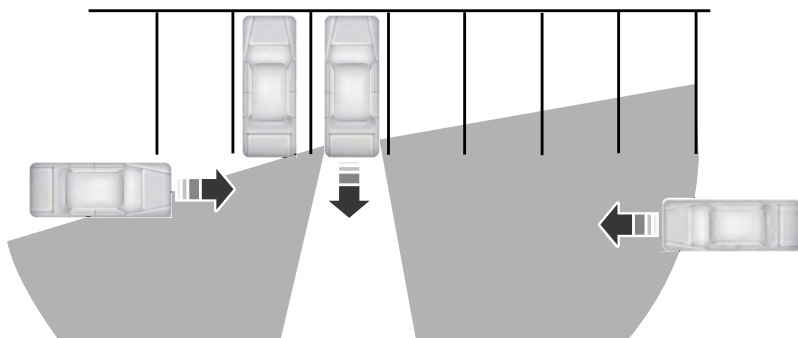

E142440

In this first example, the left sensor is only partially obstructed; zone coverage to the right is nearly maximized.

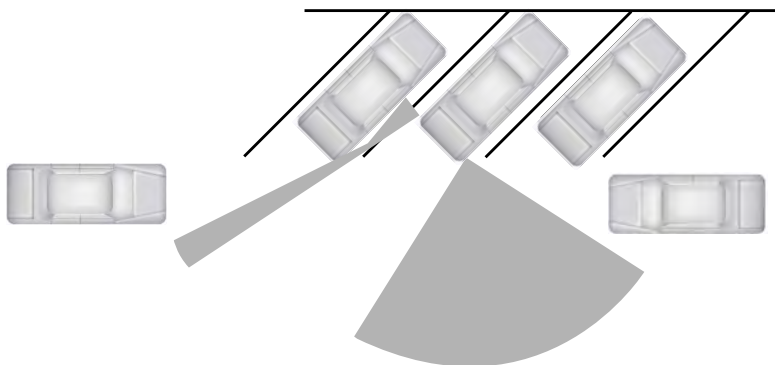

E142441

## Driving Aids

Zone coverage also decreases when parking at shallow angles. Here, the left sensor is mostly obstructed; zone coverage on that side is severely limited.

### System Lights, Messages and Audible Alerts



E142442

The Cross Traffic Alert illuminates an amber alert indicator in the outside mirror on the side of your vehicle the approaching vehicle is coming from. Cross Traffic Alert also sounds an audible alert and a message appears in the information display indicating a vehicle is coming from the right or left. Cross Traffic Alert works with the reverse sensing system that sounds its own series of tones. See **Rear Parking Aid** (page 194).

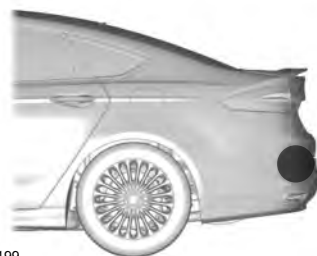

E205199

The system uses radar sensors that are located behind the bumper fascia on each side of your vehicle. Do not allow mud, snow or bumper stickers to obstruct these areas, this can cause degraded system performance. See **Blind Spot Information System** (page 219). If the Blind Spot Information System is blocked, Cross Traffic Alert is also blocked. A corresponding message appears in the information display as soon as you shift the transmission into reverse (R).

### System Limitations

Cross Traffic Alert has its limitations; situations such as severe weather conditions or debris build-up on the sensor area may limit vehicle detection.

# Driving Aids

The following are other situations that may limit the Cross Traffic Alert performance:

- Adjacently parked vehicles or objects obstructing the sensors.
- Approaching vehicles passing at speeds greater than 37 mph (60 km/h).
- Driving in reverse faster than 7 mph (12 km/h).
- Backing out of an angled parking spot.

## False Alerts

**Note:** *If your vehicle has a tow bar with a factory equipped trailer tow module and it is towing a trailer, the sensors will automatically turn the Cross Traffic Alert off. If your vehicle has a tow bar but no factory equipped trailer tow module, it is recommended to turn the Cross Traffic Alert off manually. Operating Cross Traffic Alert with a trailer attached will cause poor Cross Traffic Alert performance.*

There may be certain instances when there is a false alert by the Cross Traffic Alert system that illuminates the alert indicator with no vehicle in the coverage zone. Some amount of false alerts are normal; they are temporary and self-correct.

## System Errors

If Cross Traffic Alert senses a problem with the left or right sensor a message will appear in the information display. See **Information Messages** (page 113).

## Switching the System Off and On

You can temporarily switch Cross Traffic Alert off in the information display. See **General Information** (page 99). When you switch Cross Traffic Alert off, you will not receive alerts and the information display will display a system off message.

**Note:** *The Cross Traffic Alert switches on whenever the ignition is switched on and ready to provide appropriate alerts when the transmission is in reverse (R). Cross Traffic Alert will not remember the last selected on or off setting.*

You can also have Cross Traffic Alert switched off permanently at an authorized dealer. Once switched off permanently, the system can only be switched back on at an authorized dealer.

## STEERING

### Electric Power Steering

#### WARNINGS



The electric power steering system has diagnostic checks that continuously monitor the system. If a fault is detected, a message displays in the information display. Stop your vehicle as soon as it is safe to do so. Switch the ignition off. After at least 10 seconds, switch the ignition on and watch the information display for a steering system warning message. If a steering system warning message returns, have the system checked by an authorized dealer.



If the system detects an error, you may not feel a difference in the steering, however a serious condition may exist. Obtain immediate service from an authorized dealer, failure to do so may result in loss of steering control.

Your vehicle has an electric power steering system. There is no fluid reservoir. No maintenance is required.

If your vehicle loses electrical power while you are driving, electric power steering assistance is lost. The steering system still operates and you can steer your vehicle manually. Manually steering your vehicle requires more effort.

# Driving Aids

Extreme continuous steering may increase the effort required for you to steer your vehicle. This increased effort prevents overheating and permanent damage to the steering system. You do not lose the ability to steer your vehicle manually. Typical steering and driving maneuvers allow the system to cool and return to normal operation.

## Steering Tips

If the steering wanders or pulls, check for:

- Correct tire pressures.
- Uneven tire wear.
- Loose or worn suspension components.
- Loose or worn steering components.
- Improper vehicle alignment.

**Note:** A high crown in the road or high crosswinds may also make the steering seem to wander or pull.

## Adaptive Learning

The electronic power steering system adaptive learning helps correct road irregularities and improves overall handling and steering feel. It communicates with the brake system to help operate advanced stability control and accident avoidance systems. Additionally, whenever the battery is disconnected or a new battery installed, you must drive your vehicle a short distance before the system relearns the strategy and reactivates all systems.

## PRE-COLLISION ASSIST (if

Equipped)

### WARNINGS



This system is an extra driving aid. It does not replace your attention and judgment, or the need to apply the brakes. This system does NOT automatically brake your vehicle. If you fail to press the brake pedal when necessary, you may collide with another vehicle.



The Pre-Collision Assist system with brake support cannot help prevent all collisions. Do not rely on this system to replace your judgment and the need to maintain correct distance and speed.

**Note:** The system does not detect, warn or respond to potential collisions with vehicles to the rear or sides of your vehicle.

**Note:** The Pre-Collision Assist system is active at speeds above approximately 5 mph (8 km/h).



E156130

The system alerts you of certain collision risks. The system's sensor detects your vehicle's rapid approach to other vehicles traveling in the same direction as your vehicle.

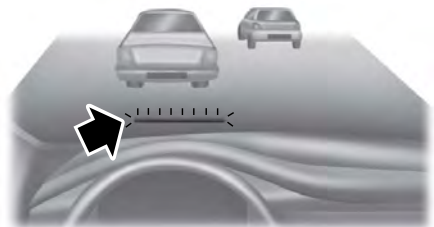

E156131



# Driving Aids

When your vehicle rapidly approaches another vehicle, a red warning light flashes and a tone sounds.

The brake support system assists you in reducing any collision speed by pre-charging the brakes. If the risk of collision continues to increase after the audio-visual warning, the brake support prepares the brake system for rapid braking. The system does not automatically activate the brakes, but if the brake pedal is pressed even lightly, the brakes apply full stopping power.

## Using the Pre-Collision Assist System

### WARNING



The Pre-Collision Assist system's brake support reduces collision speed only if you brake your vehicle before any collision. As in any typical braking situation, you must press your brake pedal.

You can adjust the warning system's sensitivity through your information display. See **General Information** (page 99).

**Note:** *When possible, the manufacturer recommends using the highest sensitivity setting. If warnings are too frequent, you can reduce your system's sensitivity. Reduced sensitivity causes fewer and later system warnings. See **General Information** (page 99).*

## Blocked Sensors



E145632

If a blocked sensor message appears in the information display, dirt, water, or an object is blocking the sensor. The sensor is located behind a cover near the driver side of the lower grille. If anything blocks the sensor, your vehicle cannot see through the sensor, and the pre-collision assist system will not work. Possible causes for the blocked sensor message and corrective actions are listed below.

# Driving Aids

| Cause   | Action  |
|---|---|
| The radar sensor cover in the grille is dirty or obstructed                           | Clean the radar sensor cover or remove the obstruction  |
| The surface of the radar sensor cover is clean but the message remains in the display | Wait a short time. The radar may take several minutes to reset after you remove the obstruction   |
| Heavy rain, spray, snow or fog in the air interferes with the radar signals           | The Pre-Collision Assist system is temporarily disabled. Shortly after weather conditions improve, the collision warning system automatically reactivates |
| Swirling water, snow or ice on the road surface interferes with the radar signals     | The Pre-Collision Assist system is temporarily disabled. Shortly after weather conditions improve, the collision warning system automatically reactivates |

## System Limitations

### WARNING



The Pre-Collision Assist system's brake support only reduces collision speed if you first apply your brakes.

You must brake as you would in any typical braking situation.

Due to the nature of radar technology, there may be certain instances where vehicles do not provide a collision warning. These include:

- Stationary vehicles or vehicles moving below 6 mph (10 km/h).
- Pedestrians or objects in the roadway.
- Oncoming vehicles in the same lane.
- Severe weather conditions (see blocked sensor section).
- Debris build-up on the grille near the headlamps (see blocked sensor section).
- Small distance to vehicle ahead.
- Large steering wheel and pedal movements (very active driving style).

Damage to the front end of your vehicle may alter the radar sensor's coverage area. This may result in missed or false collision warnings. Have an authorized dealer check your radar sensor for proper coverage and operation.

# Load Carrying

## REAR UNDER FLOOR STORAGE

### Cargo Management System (If Equipped)

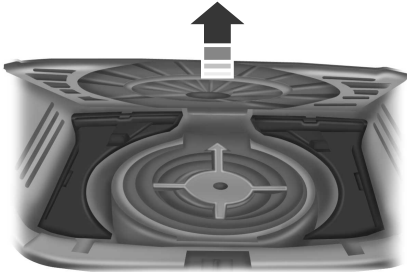

E142445

The system is located in the floor of the cargo area. Lift the handle to open.

### Adjustable Load Floor (If Equipped)

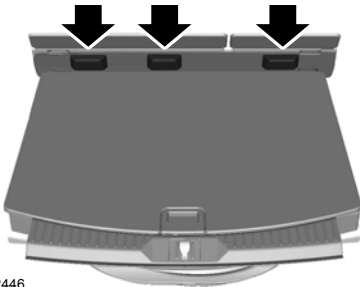

E142446

Vehicles with the standard size spare tire can adjust the load floor to two positions. The front of the load floor can be placed either on (for high position) or below (for low position) the ledges behind the rear seats. The rear of the load floor always sits on the two small shelves located on the liftgate trim.

## CARGO NETS (If Equipped)

### WARNING



This net is not designed to restrain objects during a collision or heavy braking.

The cargo net secures lightweight objects in the cargo area. Attach the net to the anchors provided. Repeat the attachment on both sides of the vehicle.





E204323

# Load Carrying

## LUGGAGE COVERS

### WARNINGS

 Make sure that the posts are properly latched in mounting features. The cover may cause injury in a sudden stop or accident if it is not securely installed.

 Do not place any objects on the cargo area shade. They may obstruct your vision or strike occupants of your vehicle in a sudden stop or crash.

Use the cargo shade to cover items in the cargo area of your vehicle.

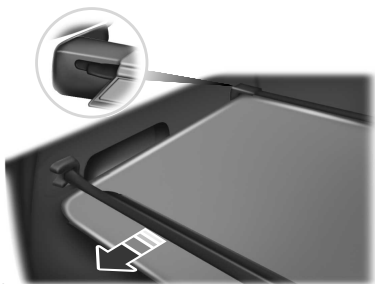

E142447

Insert the ends of the cargo shade into the mounting features located behind the rear seat on the rear trim panels to install the cargo shade.

To operate the cargo shade:

1. Pull the rear edge of the cargo shade rearward.
2. Secure both ends of the support rod into the retention slots located on the rear quarter trim panels.

## ROOF RACKS AND LOAD CARRIERS

### WARNING

 When loading the roof racks, we recommend you evenly distribute the load, as well as maintain a low center of gravity. Loaded vehicles, with higher centers of gravity, may handle differently than unloaded vehicles. Take extra precautions, such as slower speeds and increased stopping distance, when driving a heavily loaded vehicle.

The maximum recommended load, evenly distributed on the crossbars, is:

- 100 lb (45 kg) for vehicles without a moonroof.
- 45 lb (20 kg) for vehicles with a moonroof.

For correct roof rack system function, you must place loads directly on crossbars affixed to the roof rack side rails. When using the roof rack system, we recommend you use Ford Genuine Accessory crossbars designed specifically for your vehicle.

Make sure that you securely fasten the load. Check the tightness of the load before driving and at each fuel stop.

### Thumbwheel Kit

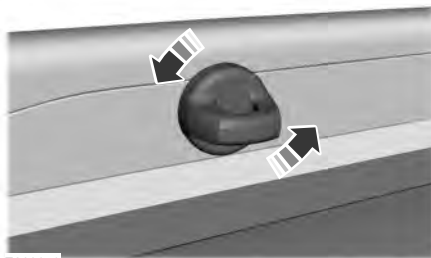

E203659

# Load Carrying

A thumbwheel kit is included in your vehicle for tying light loads to your roof. The kit is located in the glovebox.

Make sure to check that the thumbwheels are tight each time you add or remove load from the roof rack, and periodically while traveling. Make sure that the load is secure before traveling.

**Note:** *There may be snap caps in the side rail, which must be removed before installing the thumbwheels. These caps can be removed by using a T25 torx tool or a similar tool.*

## Adjusting the Crossbar (If Equipped)

**Note:** *For less wind noise and better aerodynamics, only install the crossbars when you need them for carrying cargo. Follow the steps to reposition or remove the rear crossbar. You can remove the front crossbar fasteners by unscrewing the assembly.*

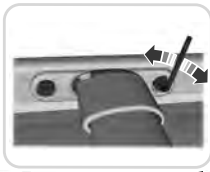

E203063

1. Remove the crossbar bolts at both sides of the front crossbar by using the supplied torx tool or a similar tool.
2. Remove the crossbar by sliding the ends off of the side rails.
3. Move the crossbar to the new side rail position and slide onto rail.

4. Replace and tighten the bolts at both sides of the crossbar by using the supplied torx tool or a similar tool.

**Note:** *There may be snap caps in the new side rail position, which must be removed before installing the crossbar. These caps can be removed by using the supplied torx tool or a similar tool.*

## LOAD LIMIT

### Vehicle Loading - with and without a Trailer

This section will guide you in the proper loading of your vehicle, trailer or both, to keep your loaded vehicle weight within its design rating capability, with or without a trailer. Properly loading your vehicle will provide maximum return of vehicle design performance. Before loading your vehicle, familiarize yourself with the following terms for determining your vehicle's weight ratings, with or without a trailer, from the vehicle's Tire Label or Safety Compliance Certification Label:

**Base Curb Weight** - is the weight of the vehicle including a full tank of fuel and all standard equipment. It does not include passengers, cargo, or optional equipment.

**Vehicle Curb Weight** - is the weight of your new vehicle when you picked it up from your authorized dealer plus any aftermarket equipment.

# Load Carrying

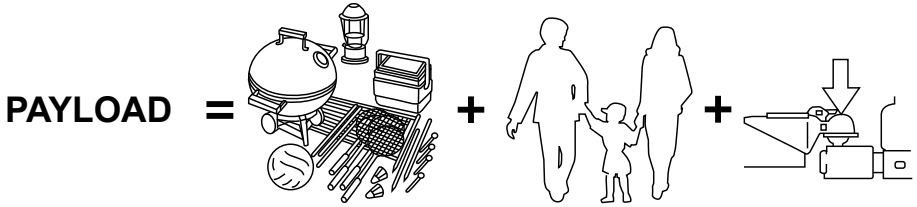

E143816

**Payload** - is the combined weight of cargo and passengers that the vehicle is carrying. The maximum payload for your vehicle can be found on the Tire Label on the B-Pillar or the edge of the driver door (vehicles exported outside the US and Canada may not have a Tire Label). Look for **“THE COMBINED WEIGHT OF OCCUPANTS AND CARGO SHOULD NEVER EXCEED XXX kg OR XXX lb.”** for maximum payload. The payload listed on the Tire Label is the maximum payload for the vehicle as built by the assembly plant. If you install any aftermarket or authorized-dealer installed equipment on the vehicle, you must subtract the weight of the equipment from the payload listed on the Tire Label in order to determine the new payload.

## WARNING

 The appropriate loading capacity of your vehicle can be limited either by volume capacity (how much space is available) or by payload capacity (how much weight the vehicle should carry). Once you have reached the maximum payload of your vehicle, do not add more cargo, even if there is space available. Overloading or improperly loading your vehicle can contribute to loss of vehicle control and vehicle rollover.

### Example only:

| TIRE AND LOADING INFORMATION  |                          |                                    |         |  |
|---|--------------------------|------------------------------------|---------|--|
| SEATING CAPACITY  |                          | TOTAL 5                            | FRONT 2 | REAR 3                                       |
| The combined weight of occupants and cargo should never exceed XXX kg or XXX lbs. |                          |                                    |         | SEE OWNERS MANUAL FOR ADDITIONAL INFORMATION |
| TIRE  | SIZE                     | COLD TIRE PRESSURE                 |         |  |
| FRONT   | L7225/75R 16.5E          | 200 KPA, 29 PSI                    |         |  |
| REAR  | L7225/75R 16.5E          | 200 KPA, 29 PSI                    |         |  |
| SPARE   | T145/80D16<br>P225/60R17 | 420 KPA, 60 PSI<br>200 KPA, 29 PSI |         |  |

E210944

# Load Carrying

| TIRE AND LOADING INFORMATION<br>RENSEIGNEMENTS SUR LES PNEUS ET LE CHARGEMENT   |                 |  |   |
|---|-----------------|--|---|
| SEATING CAPACITY<br>NOMBRE DE PLACES  |                 | TOTAL 5  | #FRONT 2 #REAR 3  |
| The combined weight of occupants and cargo should never exceed 492 kg or 1085 lbs.<br>Le poids total des occupants et du chargement ne doit jamais dépasser |                 |  |   |
| TIRE PNEU   | SIZE DIMENSIONS | COLD TIRE PRESSURE<br>PRESSION DES PNEUS A FROID | SEE OWNERS MANUAL FOR<br>ADDITIONAL<br>INFORMATION<br>VOIR LE MANUEL<br>DE L'USAGER<br>POUR PLUS DE<br>RENSEIGNEMENTS |
| FRONT AVANT   | P235/70R16      | 240 KPA, 35 PSI                                  |                                      |
| REAR ARRIERE  | P235/70R16      | 240 KPA, 35 PSI                                  |   |
| SPARE DE SECOURS  | T145/90R17      | 415 KPA, 60 PSI                                  |   |

E210945

CARGO

=



+

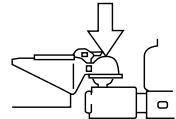

E143817

**Cargo Weight** - includes all weight added to the Base Curb Weight, including cargo and optional equipment. When towing, trailer tongue load or king pin weight is also part of cargo weight.

**GAW (Gross Axle Weight)** - is the total weight placed on each axle (front and rear) including vehicle curb weight and all payload.

**GAWR (Gross Axle Weight Rating)** - is the maximum allowable weight that can be carried by a single axle (front or rear). These numbers are shown on the Safety Compliance

Certification Label. The label shall be affixed to either the door hinge pillar, door-latch post, or the door edge that meets the door-latch post, next to the driver seating position. **The total load on each axle must never exceed its Gross Axle Weight Rating.**

**Note:** For trailer towing information refer to the RV and Trailer Towing Guide available at an authorized dealer.

# Load Carrying

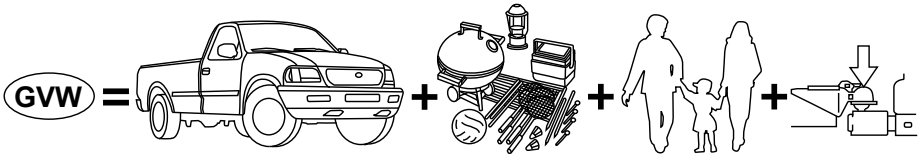

E143818

**GVW (Gross Vehicle Weight)** - is the Vehicle Curb Weight, plus cargo, plus passengers.

**GVWR (Gross Vehicle Weight Rating)** - is the maximum allowable weight of the fully loaded vehicle (including all options, equipment, passengers and cargo). It is shown on the

Safety Compliance Certification Label. The label shall be affixed to either the door hinge pillar, door-latch post, or the door edge that meets the door-latch post, next to the driver seating position. **The Gross Vehicle Weight must never exceed the Gross Vehicle Weight Rating.**

**Example only:**

MFD. BY FORD MOTOR CO.

DATE: XX/XX GVWR: XXXX KG (XXXX LB)

FRONT GAWR: XXXX KG (XXXX LB) WITH REAR GAWR: XXXX KG (XXXX LB) WITH  
 XXXXXXXXXXXXXXXX TIRES XXXXXXXXXXXXXXXX TIRES XXXX  
 XXXXXXXX RIMS XXXXXXXX RIMS  
 AT XXXX kPa/ XXX PSI COLD AT XXXX kPa/ XXX PSI COLD

THIS VEHICLE CONFORMS TO ALL APPLICABLE FEDERAL MOTOR VEHICLE SAFETY AND THEFT PREVENTION STANDARDS IN EFFECT ON THE DATE OF MANUFACTURE SHOWN ABOVE.

VIN: XXXXXXXXXXXXXXXXXXXX XXXXX  
 TYPE: XXXX XXXXX

|          |        |              |     |      |      |                  |
|----------|--------|--------------|-----|------|------|------------------|
| EXT PNT: | XX     | XXXXXXXX     | RC: | XX   | DSO: | XXXX             |
| WB       | INT TR | TP/PS        | R   | AXLE | TR   | SPR              |
| XXX      | XX     | XXX          | X   | XX   | X    | XXXX             |
|          |        | XXXXXXXXXXXX |     | XXX  |      | XXXX-XXXXXXXX-XX |

MFD. BY FORD MOTOR CO.

DATE: xx/xx GVWR/PNBV: xxxxx LB/xxxxx KG

FRONT GAWR/PNBE AY / REAR GAWR/ PNBE AR  
 xxxxx / xxxxx B / xxxxx KG/ xxxxx B  
 WITH/AVEC TIRES/PNEUS  
 xxxxx / xxxxxx  
 xxxxx / xxxxxx  
 xxxxxxx RIMS/JANTES xxxxxxx

AT/A kPa/PSI/LPC xxx/xx COLD/A FROID xxx/xx /JUMEELES

VIN: xxxxxxxxxxxxxxxxxxxx  
 TYPE: xxx/xxxx COMPLETES: xxxxx/xxxx - xxxxx

|          |        |              |     |      |      |                   |
|----------|--------|--------------|-----|------|------|-------------------|
| EXT PNT: | U      |              | RC: | xx   | DSO: |                   |
| WB       | INT TR | TP/PS        | R   | AXLE | TR   | SPR               |
| xxx      | xx     |              | x   | xx   | x    | xxxxx             |
|          |        | XXXXXXXXXXXX |     | xxx  |      | xxxxx-xxxxxxxx-xx |

E198828



# Load Carrying

## WARNING



Exceeding the Safety Compliance Certification Label vehicle weight rating limits could result in substandard vehicle handling or performance, engine, transmission and/or structural damage, serious damage to the vehicle, loss of control and personal injury.

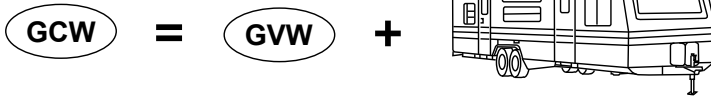

E143819

**GCW (Gross Combined Weight)** - is the Gross Vehicle Weight plus the weight of the fully loaded trailer.

**GCWR (Gross Combined Weight Rating)** - is the maximum allowable weight of the vehicle and the loaded trailer, including all cargo and passengers, that the vehicle can handle without risking damage. (Important: The towing vehicle's braking system is rated for operation at Gross Vehicle Weight Rating, not at Gross Combined Weight Rating.) Separate functional brakes should be used for safe control of towed vehicles and for trailers where the Gross Combined Weight of the

towing vehicle plus the trailer exceed the Gross Vehicle Weight Rating of the towing vehicle. **The Gross Combined Weight must never exceed the Gross Combined Weight Rating.**

**Maximum Loaded Trailer Weight** - is the highest possible weight of a fully loaded trailer the vehicle can tow. It assumes a vehicle with mandatory options, driver and front passenger weight (150 pounds [68 kilograms] each), no cargo weight (internal or external) and a tongue load of 10–15% (conventional trailer) or king pin weight of 15–25% (fifth wheel trailer). Consult an authorized dealer (or the RV and Trailer Towing Guide available at an authorized dealer) for more detailed information.

# Load Carrying

**Tongue Load or Fifth Wheel King Pin Weight** - refers to the amount of the weight that a trailer pushes down on a trailer hitch.

**Examples:** For a 5000 pound (2268 kilogram) conventional trailer, multiply 5000 by 0.10 and 0.15 to obtain a proper tongue load range of 500 to 750 pounds (227 to 340 kilograms). For an 11500 pound (5216 kilogram) fifth wheel trailer, multiply by 0.15 and 0.25 to obtain a proper king pin load range of 1725 to 2875 pounds (782 to 1304 kilograms).

## WARNINGS



Do not exceed the GVWR or the GAWR specified on the Safety Compliance Certification Label.



Do not use replacement tires with lower load carrying capacities than the original tires because they may lower the vehicle's GVWR and GAWR limitations. Replacement tires with a higher limit than the original tires do not increase the GVWR and GAWR limitations.



Exceeding any vehicle weight rating limitation could result in serious damage to the vehicle and/or personal injury.

## Steps for determining the correct load limit:

1. Locate the statement "The combined weight of occupants and cargo should never exceed XXX kg or XXX lb." on your vehicle's placard.
2. Determine the combined weight of the driver and passengers that will be riding in your vehicle.
3. Subtract the combined weight of the driver and passengers from XXX kg or XXX lb.
4. The resulting figure equals the available amount of cargo and luggage load capacity. For example, if the "XXX" amount equals 1,400 lb. and there will be five 150 lb. passengers in your vehicle, the amount of available cargo and luggage load capacity is 650 lb. (1400-750 (5 x 150) = 650 lb.).
5. Determine the combined weight of luggage and cargo being loaded on the vehicle. That weight may not safely exceed the available cargo and luggage load capacity calculated in Step 4.
6. If your vehicle will be towing a trailer, load from your trailer will be transferred to your vehicle. Consult this manual to determine how this reduces the available cargo and luggage load capacity of your vehicle.

The following gives you a few examples on how to calculate the available amount of cargo and luggage load capacity:

## Load Carrying

---

\*Suppose your vehicle has a 1400-pound (635-kilogram) cargo and luggage capacity. You decide to go golfing. Is there enough load capacity to carry you, four of your friends and all the golf bags? You and four friends average 220 pounds (99 kilograms) each and the golf bags weigh approximately 30 pounds (13.5 kilograms) each. The calculation would be:  $1400 - (5 \times 220) - (5 \times 30) = 1400 - 1100 - 150 = 150$  pounds. Yes, you have enough load capacity in your vehicle to transport four friends and your golf bags. In metric units, the calculation would be:  $635 \text{ kilograms} - (5 \times 99 \text{ kilograms}) - (5 \times 13.5 \text{ kilograms}) = 635 - 495 - 67.5 = 72.5$  kilograms.

\*Suppose your vehicle has a 1400-pound (635-kilogram) cargo and luggage capacity. You and one of your friends decide to pick up cement from the local home improvement store to finish that patio you have been planning for the past two years. Measuring the inside of the vehicle with the rear seat folded down, you have room for twelve 100-pound (45-kilogram) bags of cement. Do you have enough load capacity to transport the cement to your home? If you and your friend each weigh 220 pounds (99 kilograms), the calculation would be:  $1400 - (2 \times 220) - (12 \times 100) = 1400 - 440 - 1200 = -240$  pounds. No, you do not have enough cargo capacity to carry that much weight. In metric units, the calculation would

be:  $635 \text{ kilograms} - (2 \times 99 \text{ kilograms}) - (12 \times 45 \text{ kilograms}) = 635 - 198 - 540 = -103$  kilograms. You will need to reduce the load weight by at least 240 pounds (104 kilograms). If you remove three 100-pound (45-kilogram) cement bags, then the load calculation would be:  $1400 - (2 \times 220) - (9 \times 100) = 1400 - 440 - 900 = 60$  pounds. Now you have the load capacity to transport the cement and your friend home. In metric units, the calculation would be:  $635 \text{ kilograms} - (2 \times 99 \text{ kilograms}) - (9 \times 45 \text{ kilograms}) = 635 - 198 - 405 = 32$  kilograms.

The above calculations also assume that the loads are positioned in your vehicle in a manner that does not overload the Front or the Rear Gross Axle Weight Rating specified for your vehicle on the Safety Compliance Certification Label. The label shall be affixed to either the door hinge pillar, door-latch post, or the door edge that meets the door-latch post, next to the driver seating position.

# Load Carrying

---

## Special Loading Instructions for Owners of Pick-up Trucks and Utility-type Vehicles

### WARNING



Loaded vehicles may handle differently than unloaded vehicles. Extra precautions, such as slower speeds and increased stopping distance, should be taken when driving a heavily loaded vehicle.

---

Your vehicle can haul more cargo and people than most passenger cars. Depending upon the type and placement of the load, hauling cargo and people may raise the center of gravity of the vehicle.

# Towing

---

## TOWING A TRAILER

### WARNINGS



Do not exceed the GVWR or the GAWR specified on the certification label.



Towing trailers beyond the maximum recommended gross trailer weight exceeds the limit of the vehicle and could result in engine damage, transmission damage, structural damage, loss of vehicle control, vehicle rollover and personal injury.

---

Your vehicle may have electrical items, such as fuses or relays, related to towing. See **Fuses** (page 263).

Your vehicle's load capacity designation is by weight, not by volume, so you cannot necessarily use all available space when loading a vehicle or trailer.

Towing a trailer places an extra load on your vehicle's engine, transmission, axle, brakes, tires and suspension. Inspect these components periodically during, and after, any towing operation.

## Load Placement

To help minimize how trailer movement affects your vehicle when driving:

- Load the heaviest items closest to the trailer floor.
- Load the heaviest items centered between the left and right side trailer tires.
- Load the heaviest items above the trailer axles or just slightly forward toward the trailer tongue. Do not allow the final trailer tongue weight to go above or below 10-15% of the loaded trailer weight.
- Select a ball mount with the correct rise or drop. When both the loaded vehicle and trailer are connected, the trailer frame should be level, or slightly angled down toward your vehicle, when viewed from the side.

When driving with a trailer or payload, a slight takeoff vibration or shudder may be present due to the increased payload weight. Additional information regarding proper trailer loading and setting your vehicle up for towing is located in another chapter of this manual. See **Load Limit** (page 231).

You can also find information in the **RV & Trailer Towing Guide** available at your authorized dealer, or online.

# Towing

## RV & Trailer Towing Guide Online

Website <http://www.fleet.ford.com/towing-guides/>

### TRAILER SWAY CONTROL (if

Equipped)

#### WARNING



Turning off trailer sway control increases the risk of loss of vehicle control, serious injury or death. Ford does not recommend disabling this feature except in situations where speed reduction may be detrimental (such as hill climbing), the driver has significant trailer towing experience, and can control trailer sway and maintain safe operation.

**Note:** This feature does not prevent trailer sway, but reduces it when it begins.

**Note:** This feature cannot stop all trailers from swaying.

**Note:** In some cases, if your vehicle speed is too high, the system may turn on multiple times, gradually reducing your vehicle speed.

The system applies the brakes to the individual wheels and reduces engine torque to aid vehicle stability. If the trailer begins to sway, the stability control warning lamp flashes and a message appears in the information display. See **Information Messages** (page 113). Slow your vehicle down, pull safely to the side of the road and check for correct load distribution. See **Load Carrying** (page 229).

You can switch this feature off in the information display. When you switch the ignition on, the system automatically turns on.

### RECOMMENDED TOWING WEIGHTS

**Note:** Do not exceed the trailer weight for your vehicle configuration listed in the chart below.

**Note:** Be sure to take into consideration trailer frontal area. Do not exceed 20 feet<sup>2</sup> (1.86 meters<sup>2</sup>) if your vehicle can tow a class I trailer or 40 feet<sup>2</sup> (3.72 meters<sup>2</sup>) if your vehicle can tow a class III trailer.

**Note:** For high altitude operation, reduce the gross combined weight by 2% per 1000 feet (300 meters) starting at the 1000 foot (300 meter) elevation point.

**Note:** Certain states require electric trailer brakes for trailers over a specified weight. Be sure to check state regulations for this specified weight. The maximum trailer weights listed may be limited to this specified weight, as the vehicle's electrical system may not include the wiring connector needed to activate electric trailer brakes.

## Towing

Your vehicle may tow a trailer provided the maximum trailer weight is less than or equal to the maximum trailer weight listed for your vehicle configuration on the following chart.

| <b>Engine</b>               | <b>Maximum GCWR</b> | <b>Maximum trailer weight</b>  |
|-----------------------------|---------------------|--------------------------------|
| 2.3L GTDI 2WD <sup>1</sup>  | 6900 lb (3130 kg)   | 2000 lb (907 kg)               |
| 3.5L TiVCT 2WD <sup>1</sup> | 6900 lb (3130 kg)   | 2000 lb (907 kg)               |
| 2.3L GTDI 2WD <sup>2</sup>  | 7950 lb (3606 kg)   | 3000 lb (1361 kg)              |
| 3.5L TiVCT 2WD <sup>2</sup> | 9950 lb (4513 kg)   | 5000 lb (2268 kg) <sup>3</sup> |
| 2.3L GTDI 4WD <sup>1</sup>  | 7100 lb (3221 kg)   | 2000 lb (907 kg)               |
| 3.5L TiVCT 4WD <sup>1</sup> | 7100 lb (3221 kg)   | 2000 lb (907 kg)               |
| 2.3L GTDI 4WD <sup>2</sup>  | 8150 lb (3697 kg)   | 3000 lb (1361 kg)              |
| 3.5L TiVCT 4WD <sup>2</sup> | 10150 lb (4604 kg)  | 5000 lb (2268 kg)              |
| 3.5L GTDI 4WD <sup>2</sup>  | 10400 lb (4717 kg)  | 5000 lb (2268 kg)              |

<sup>1</sup> Without trailer towing package.

<sup>2</sup> With trailer towing package.

<sup>3</sup> For towing trailers up to 3500 pounds (1588 kilograms), use a weight-carrying hitch and ball, which uniformly spreads the trailer tongue loads through your vehicle's underbody structure. For towing trailers over 3500 pounds (1588 kilograms), up to the maximum trailer weight, we recommend you use a weight-distributing hitch to increase front axle load while towing.

# Towing

## ESSENTIAL TOWING CHECKS

Follow these guidelines for safe towing:

- Do not tow a trailer until you drive your vehicle at least 1,000 mi (1,600 km).
- Consult your local motor vehicle laws for towing a trailer.
- See the instructions included with towing accessories for the proper installation and adjustment specifications.
- Service your vehicle more frequently if you tow a trailer. See your scheduled maintenance information.
- If you use a rental trailer, follow the instructions the rental agency gives you.

You can find information on load specification terms found on the tire label and Safety Compliance label as well as instructions on calculating your vehicle's load in the Load Carrying chapter. See **Load Limit** (page 231).

Remember to account for the trailer tongue weight as part of your vehicle load when calculating the total vehicle weight.

## Hitches

Do not use a hitch that either clamps onto the bumper or attaches to the axle.

Distribute the trailer load so 10-15% of the total trailer weight is on the tongue.

## Weight-distributing Hitches

### WARNING



Do not adjust a weight-distributing hitch to any position where the rear bumper of the vehicle is higher than it was before attaching the trailer. Doing so will defeat the function of the weight-distributing hitch, which may cause unpredictable handling, and could result in serious personal injury.

When hooking-up a trailer using a weight-distributing hitch, always use the following procedure:

1. Park the loaded vehicle, without the trailer, on a level surface.
2. Measure the height to the top of your vehicle's front wheel opening on the fender. This is H1.
3. Attach the loaded trailer to your vehicle without the weight-distributing bars connected.
4. Measure the height to the top of your vehicle's front wheel opening on the fender a second time. This is H2.
5. Install and adjust the tension in the weight-distributing bars so that the height of your vehicle's front wheel opening on the fender is approximately half the way down from H2, toward H1.
6. Check that the trailer is level or slightly nose down toward your vehicle. If not, adjust the ball height accordingly and repeat Steps 2-6.

When the trailer is level or slightly nose down toward the vehicle:

- Lock the bar tension adjuster in place.
- Check that the trailer tongue securely attaches and locks onto the hitch.
- Install safety chains, lighting, and trailer brake controls as required by law or the trailer manufacturer.

## Safety Chains

**Note:** *Never attach safety chains to the bumper.*

Always connect the safety chains to the hook retainers of your vehicle hitch.

To connect the trailer's safety chains, cross them under the trailer tongue and allow enough slack for turning tight corners. Do not allow the chains to drag on the ground.



# Towing

## Trailer Brakes

### WARNING



Do not connect a trailer's hydraulic brake system directly to your vehicle's brake system. Your vehicle may not have enough braking power and your chances of having a collision greatly increase.

Electric brakes and manual, automatic or surge-type trailer brakes are safe if you install them properly and adjust them to the manufacturer's specifications. The trailer brakes must meet local and federal regulations.

**The rating for the tow vehicle's braking system operation is at the gross vehicle weight rating, not the gross combined weight rating.**

**Separate functioning brake systems are required for safe control of towed vehicles and trailers weighing more than 1500 pounds (680 kilograms) when loaded.**

## Trailer Lamps

### WARNING



Never connect any trailer lamp wiring to the vehicle's tail lamp wiring; this may damage the electrical system resulting in fire. Contact your authorized dealer as soon as possible for assistance in proper trailer tow wiring installation. Additional electrical equipment may be required.

Trailer lamps are required on most towed vehicles. Make sure all running lights, brake lights, turn signals and hazard lights are working.

## Before Towing a Trailer

Practice turning, stopping and backing up to get the feel of your vehicle-trailer combination before starting on a trip. When turning, make wider turns so the trailer wheels clear curbs and other obstacles.

## When Towing a Trailer

- Do not drive faster than 70 mph (113 km/h) during the first 500 mi (800 km).
- Do not make full-throttle starts.
- Check your hitch, electrical connections and trailer wheel lug nuts thoroughly after you have traveled 50 mi (80 km).
- When stopped in congested or heavy traffic during hot weather, place the gearshift in position **P** to aid engine and transmission cooling and to help A/C performance.
- Turn off the speed control with heavy loads or in hilly terrain. The speed control may turn off automatically when you are towing on long, steep grades.
- Shift to a lower gear when driving down a long or steep hill. Do not apply the brakes continuously, as they may overheat and become less effective.
- If your transmission is equipped with a Grade Assist or Tow/Haul feature, use this feature when towing. This provides engine braking and helps eliminate excessive transmission shifting for optimum fuel economy and transmission cooling.
- Allow more distance for stopping with a trailer attached. Anticipate stops and brake gradually.
- Avoid parking on a grade. However, if you must park on a grade:
  1. Turn the steering wheel to point your vehicle tires away from traffic flow.

# Towing

2. Set your vehicle parking brake.
3. Place the automatic transmission in position **P**.
4. Place wheel chocks in front and back of the trailer wheels. (Chocks not included with vehicle.)

## Launching or Retrieving a Boat or Personal Watercraft (PWC)

**Note:** Disconnect the wiring to the trailer **before** backing the trailer into the water.

**Note:** Reconnect the wiring to the trailer **after** removing the trailer from the water.

When backing down a ramp during boat launching or retrieval:

- Do not allow the static water level to rise above the bottom edge of the rear bumper.
- Do not allow waves to break higher than 6 in (15 cm) above the bottom edge of the rear bumper.

Exceeding these limits may allow water to enter vehicle components:

- Causing internal damage to the components.
- Affecting driveability, emissions, and reliability.

Replace the rear axle lubricant anytime the rear axle has been submerged in water. Water may have contaminated the rear axle lubricant, which is not normally checked or changed unless a leak is suspected or other axle repair is required.

## TRANSPORTING THE VEHICLE

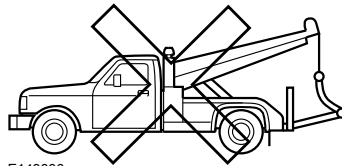
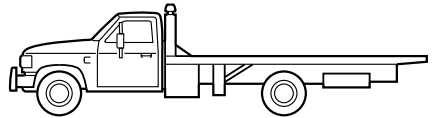
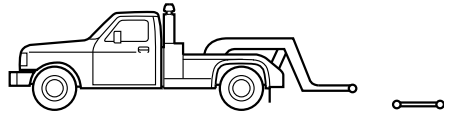

E143886

If you need to have your vehicle towed, contact a professional towing service or, if you are a member of a roadside assistance program, your roadside assistance service provider.

We recommend the use of a wheel lift and dollies or flatbed equipment to tow your vehicle. Do not tow with a slingbelt. Ford Motor Company has not approved a slingbelt towing procedure. Vehicle damage may occur if towed incorrectly, or by any other means.

Ford Motor Company produces a towing manual for all authorized tow truck operators. Have your tow truck operator refer to this manual for proper hook-up and towing procedures for your vehicle.

# Towing

It is acceptable to have your front-wheel drive vehicle towed from the front if using proper wheel lift equipment to raise the front wheels off the ground. When towing in this manner, the rear wheels can remain on the ground.

Front-wheel drive vehicles must have the front wheels placed on a tow dolly when towing your vehicle from the rear using wheel lift equipment. This prevents damage to the transmission.

Towing a four-wheel drive vehicle requires that all wheels be off the ground, such as using a wheel lift and dollies or flatbed equipment. This prevents damage to the transmission, four-wheel drive system and vehicle.

## TOWING THE VEHICLE ON FOUR WHEELS - 2.3L ECOBOOST™

### Emergency Towing

If your vehicle becomes inoperable (without access to wheel dollies, car-hauling trailer, or flatbed transport vehicle), it can be flat-towed (all wheels on the ground, regardless of the powertrain and transmission configuration) under the following conditions:

- Your vehicle is facing forward for towing in a forward direction.
- Place the transmission in position **N**. If you cannot move the transmission into **N**, you may need to override it. See **Transmission** (page 177).
- Maximum speed is 35 mph (56 km/h).
- Maximum distance is 50 mi (80 km).

### WARNING



If your vehicle has a steering wheel lock make sure the ignition is in the accessory or on position when being towed.

### Recreational Towing

**Note:** Put your climate control system in recirculated air mode to prevent exhaust fumes from entering the vehicle. See **Climate Control** (page 127).

Follow these guidelines if you have a need for recreational (RV) towing. An example of recreational towing would be towing your vehicle behind a motorhome. We designed these guidelines to prevent damage to your transmission.

Front-wheel drive vehicles **CANNOT** be flat-towed (all wheels on the ground) as vehicle or transmission damage may occur. You must place the front wheels on a two-wheel tow dolly. If you are using a tow dolly, follow the instructions specified by the equipment provider.

Four-wheel drive vehicles **CANNOT** be flat-towed (all wheels on the ground), as vehicle or transmission damage may occur. It is recommended to tow your vehicle with all four (4) wheels off the ground such as when using a car-hauling trailer. Otherwise, you cannot recreational tow your vehicle.

# Towing

## TOWING THE VEHICLE ON FOUR WHEELS - 3.5L DURATEC/3.5L ECOBOOST™

### Emergency Towing

If your vehicle becomes inoperable (without access to wheel dollies or vehicle transport trailer), it can be flat-towed (all wheels on the ground, regardless of the powertrain and transmission configuration) under the following conditions:

- Your vehicle is facing forward for towing in a forward direction.
- Shift into neutral (N). If you cannot shift into neutral (N), you may need to override it. See **Transmission** (page 177).
- Maximum speed is 35 mph (56 km/h).
- Maximum distance is 50 mi (80 km).

### WARNING



If your vehicle has a steering wheel lock make sure the ignition is in the accessory or on position when being towed.

### Recreational Towing

**Note:** Put your climate control system in recirculated air mode to prevent exhaust fumes from entering the vehicle. See **Climate Control** (page 127).

Follow these guidelines if you have a need for recreational (RV) towing. An example of recreational towing would be towing your vehicle behind a motorhome. We designed these guidelines to prevent damage to your transmission.

You can tow your 3.5L EcoBoost or 3.5L Duratec equipped vehicle with all four wheels on the ground.

If you tow your vehicle with all four wheels on the ground:

- Tow only in the forward direction.
- Release the parking brake.

### Vehicles with Keyless Start

1. Start the vehicle by pressing the brake pedal, and then pressing the keyless start button until the vehicle starts.
2. Press the brake pedal and shift the gearshift into neutral (N).
3. Turn the vehicle off by pressing the keyless start button once.
4. Disconnect the negative (black) cable from the battery. You need the door key to lock and unlock doors when the battery cable is disconnected. See **Changing the 12V Battery** (page 286).

**Note:** The anti-theft system does not work until you reconnect the battery cable.

Start the engine within 15 minutes of reconnecting the battery cable.

### Vehicles with an Ignition Key

1. Start the vehicle by pressing the brake pedal, and then turning the ignition key until the vehicle starts.
2. Press the brake pedal and shift the transmission into neutral (N).
3. Turn off your vehicle by turning the ignition key past the accessory position. The key position is between the accessory and off positions. See **Ignition Switch** (page 162).
4. Disconnect the negative (black) cable from the battery. See **Changing the 12V Battery** (page 286).

**Note:** The anti-theft system does not work until you reconnect the battery cable.

Start the engine within 15 minutes of reconnecting the battery cable.

# Towing

---

## All Vehicles

- Do not exceed 65 mph (105 km/h).
- Start the engine and allow it to run for five minutes at the beginning of each day and every six hours thereafter. With the engine running and your foot on the brake, shift into drive (D) and then into reverse (R) before shifting back into neutral (N).

## Front-wheel Drive Vehicles

Alternatively, you can tow your front-wheel drive vehicle with the front wheels off the ground by using a tow dolly, or with all four wheels off the ground using a vehicle transport trailer. If you are using a tow dolly, follow the instructions specified by the equipment provider.

## Four-wheel Drive Vehicles

Alternatively, you can tow your Four-wheel Drive vehicle with all four wheels off the ground using a vehicle transport trailer. Do not tow your four-wheel Drive vehicle with the front wheels off the ground (by using a tow dolly) and the rear wheels on the ground. This causes damage to your four-wheel Drive system. If you are using a vehicle transport trailer, follow the instruction specified by the equipment provider.

# Driving Hints

---

## BREAKING-IN

You need to break in new tires for approximately 300 miles (480 kilometers). During this time, your vehicle may exhibit some unusual driving characteristics.

Avoid driving too fast during the first 1000 miles (1600 kilometers). Vary your speed frequently and change up through the gears early. Do not labor the engine.

Do not tow during the first 1000 miles (1600 kilometers).

## ECONOMICAL DRIVING

Your fuel economy is affected by several things, such as how you drive, the conditions you drive under, and how you maintain your vehicle.

You may improve your fuel economy by keeping these things in mind:

- Accelerate and slow down in a smooth, moderate fashion.
- Drive at steady speeds without stopping.
- Anticipate stops; slowing down may eliminate the need to stop.
- Combine errands and minimize stop-and-go driving.
- Close the windows for high-speed driving.
- Drive at reasonable speeds (traveling at 55 mph [88 km/h] uses 15% less fuel than traveling at 65 mph [105 km/h]).
- Keep the tires properly inflated and use only the recommended size.
- Use the recommended engine oil.
- Perform all regularly scheduled maintenance.

Avoid these actions; they reduce your fuel economy:

- Sudden accelerations or hard accelerations.
- Revving the engine before turning it off.
- Idle for periods longer than one minute.
- Warm up your vehicle on cold mornings.
- Use the air conditioner or front defroster.
- Use the speed control in hilly terrain.
- Rest your foot on the brake pedal while driving.
- Drive a heavily loaded vehicle or tow a trailer.
- Carry unnecessary weight (approximately 1 mpg [0.4 km/L] is lost for every 400 lb [180 kilogram] of weight carried).
- Driving with the wheels out of alignment.

### Conditions

- Heavily loading a vehicle or towing a trailer may reduce fuel economy at any speed.
- Adding certain accessories to your vehicle (for example bug deflectors, rollbars, light bars, running boards, ski racks or luggage racks) may reduce fuel economy.
- To maximize the fuel economy, drive with the tonneau cover installed (if equipped).
- Using fuel blended with alcohol may lower fuel economy.
- Fuel economy may decrease with lower temperatures during the first 8–10 miles (12–16 kilometers) of driving.
- Driving on flat terrain offers improved fuel economy as compared to driving on hilly terrain.

# Driving Hints

- Transmissions give their best fuel economy when operated in the top cruise gear and with steady pressure on the gas pedal.
- Four-wheel-drive operation (if equipped) is less fuel efficient than two-wheel-drive operation.
- Close the windows for high-speed driving.

## DRIVING THROUGH WATER

### WARNING



Do not drive through flowing or deep water as you may lose control of your vehicle.

**Note:** *Driving through standing water can cause vehicle damage.*

**Note:** *Engine damage can occur if water enters the air filter.*

Before driving through standing water, check the depth. Never drive through water that is higher than the bottom of the front rocker area of your vehicle.



E176360

When driving through standing water, drive very slowly and do not stop your vehicle. Your brake performance and traction may be limited. After driving through water and as soon as it is safe to do so:

- Lightly press the brake pedal to dry the brakes and to check that they work.
- Check that the horn works.
- Check that the exterior lights work.
- Turn the steering wheel to check that the steering power assist works.

## FLOOR MATS

### WARNINGS



Always use floor mats that are designed to fit the foot well of your vehicle. Only use floor mats that leave the pedal area unobstructed. Only use floor mats that are firmly secured to retention posts so that they cannot slip out of position and interfere with the pedals or impair safe operation of your vehicle in other ways.



Pedals that cannot move freely can cause loss of vehicle control and increase the risk of serious personal injury.



Always make sure that the floor mats are properly attached to the retention posts in the carpet that are supplied with your vehicle. Floor mats must be properly secured to both retention posts to make sure mats do not shift out of position.



Never place floor mats or any other covering in the vehicle foot well that cannot be properly secured to prevent them from moving and interfering with the pedals or the ability to control the vehicle.



Never place floor mats or any other covering on top of already installed floor mats. Floor mats should always rest on top of vehicle carpeting surface and not another floor mat or other covering. Additional floor mats or any other covering will reduce the pedal clearance and potentially interfere with pedal operation.

# Driving Hints

---

## WARNINGS



Check attachment of floor mats on a regular basis. Always properly reinstall and secure floor mats that have been removed for cleaning or replacement.



Always make sure that objects cannot fall into the driver foot well while the vehicle is moving. Objects that are loose can become trapped under the pedals causing a loss of vehicle control.



Failure to properly follow floor mat installation or attachment instructions can potentially cause interference with pedal operation causing a loss of vehicle control.

---



E142666

To install floor mats, position the floor mat so that the eyelet is over the retention post and press down to lock in.

To remove the floor mat, reverse the installation procedure.



# Roadside Emergencies

---

## ROADSIDE ASSISTANCE

### Vehicles Sold in the United States: Getting Roadside Assistance

To fully assist you should you have a vehicle concern, Ford Motor Company offers a complimentary roadside assistance program. This program is separate from the New Vehicle Limited Warranty. The service is available:

- 24 hours a day, seven days a week.
- For the coverage period listed on the Roadside Assistance Card included in your Owner's Manual portfolio.

Roadside Assistance covers:

- A flat tire change with a good spare, if provided with the vehicle (except vehicles supplied with a tire inflation kit).
- Battery jump start.
- Lock-out assistance (key replacement cost is the customer's responsibility).
- Fuel delivery — independent service contractors, if not prohibited by state, local or municipal law, shall deliver up to 2 gal (7.6 L) of gasoline or 5 gal (18.9 L) of diesel fuel to a disabled vehicle. Roadside Assistance limits fuel delivery service to two no-charge occurrences within a 12-month period.
- Winch out — available within 100 ft (30.5 m) of a paved or county maintained road, no recoveries.
- Towing — independent service contractors, if not prohibited by state, local or municipal law, shall tow Ford eligible vehicles to an authorized dealer within 35 mi (56 km) of the disablement location or to the nearest

authorized dealer. If a member requests a tow to an authorized dealer that is more than 35 mi (56 km) from the disablement location, the member shall be responsible for any mileage costs in excess of 35 mi (56 km).

Roadside Assistance includes up to \$200 for a towed trailer if the disabled eligible vehicle requires service at the nearest authorized dealer. If the towing vehicle is operational but the trailer is not, then the trailer does not qualify for any roadside services.

### Vehicles Sold in the United States: Using Roadside Assistance

Complete the roadside assistance identification card and place it in your wallet for quick reference. This card is in the owner's information portfolio in the glove compartment.

United States Ford vehicle customers who require Roadside Assistance, call 1-800-241-3673.

If you need to arrange roadside assistance for yourself, Ford Motor Company reimburses a reasonable amount for towing to the nearest dealership within 35 mi (56 km). To obtain reimbursement information, United States Ford vehicle customers call 1-800-241-3673. Customers need to submit their original receipts.

### Vehicles Sold in Canada: Getting Roadside Assistance

To fully assist you should you have a vehicle concern, Ford Motor Company of Canada, Limited offers a complimentary roadside assistance program. This program is eligible within Canada or the continental United States.

# Roadside Emergencies

This program is separate from the New Vehicle Limited Warranty, but the coverage is concurrent with the powertrain coverage period of your vehicle.

Canadian customers who require roadside assistance, call 1-800-665-2006.

## Vehicles Sold in Canada: Using Roadside Assistance

Complete the roadside assistance identification card and place it in your wallet for quick reference.

In Canada, this card is found in the Warranty Guide in the glove compartment of your vehicle.

## Vehicles Sold in Canada: Roadside Assistance Program Coverage

The service is available 24 hours a day, seven days a week.

Canadian roadside coverage and benefits may differ from the U.S. coverage.

For complete program coverage details you may contact your dealer, you can call us in Canada at 1-800-665-2006, or visit our website at [www.ford.ca](http://www.ford.ca).

## HAZARD WARNING FLASHERS

**Note:** *If used when the vehicle is not running, the battery will lose charge. There may be insufficient power to restart your vehicle.*



The hazard warning button is located on the instrument panel. Use it when your vehicle is creating a safety hazard for other motorists.

- Press the button to turn on the hazard warning function, and the front and rear direction indicators will flash.
- Press the button again to turn them off.

## FUEL SHUTOFF

### WARNING



Failure to inspect and, if necessary, repair fuel leaks after a collision may increase the risk of fire and serious injury. Ford Motor Company recommends that the fuel system be inspected by an authorized dealer after any collision.

In the event of a moderate to severe collision, this vehicle includes a fuel pump shutoff feature that stops the flow of fuel to the engine. Not every impact will cause a shutoff.

Should your vehicle shut off after a collision, you may restart your vehicle. For vehicles equipped with a key system:

1. Switch off the ignition.
2. Switch on the ignition.
3. Repeat Steps 1 and 2 to re-enable the fuel pump.

For vehicles equipped with a push button start system:

1. Press the **START/STOP** button to switch off the ignition.
2. Press the brake pedal and press the **START/STOP** button to switch on the ignition.
3. Remove your foot from the brake pedal and press the **START/STOP** button to switch off the ignition.
4. You can either attempt to start the engine by pressing the brake pedal and the **START/STOP** button, or switch on the ignition only by pressing the **START/STOP** button without pressing the brake pedal. Both ways re-enable the fuel system.

# Roadside Emergencies

---

**Note:** When you try to restart your vehicle after a fuel shutoff, the vehicle makes sure that various systems are safe to restart. Once your vehicle determines that the systems are safe, then the vehicle will allow you to restart.

**Note:** In the event that your vehicle does not restart after your third attempt, contact an authorized dealer.

## JUMP STARTING THE VEHICLE

### WARNINGS



Batteries normally produce explosive gases which can cause personal injury. Therefore, do not allow flames, sparks or lighted substances to come near the battery. When working near the battery, always shield your face and protect your eyes. Always provide correct ventilation.



Keep batteries out of reach of children. Batteries contain sulfuric acid. Avoid contact with skin, eyes or clothing. Shield your eyes when working near the battery to protect against possible splashing of acid solution. In case of acid contact with skin or eyes, flush immediately with water for a minimum of 15 minutes and get prompt medical attention. If acid is swallowed, call a physician immediately.



Use only adequately sized cables with insulated clamps.

---

## Preparing Your Vehicle

Do not attempt to push-start your automatic transmission vehicle.

**Note:** Attempting to push-start a vehicle with an automatic transmission may cause transmission damage.

**Note:** Use only a 12-volt supply to start your vehicle.

**Note:** Do not disconnect the battery of the disabled vehicle as this could damage the vehicle electrical system.

Park the booster vehicle close to the hood of the disabled vehicle, making sure the two vehicles do not touch.

## Connecting the Jumper Cables

### WARNINGS



Do not attach the cables to fuel lines, engine rocker covers, the intake manifold or electrical components as grounding points. Stay clear of moving parts. To avoid reverse polarity connections, make sure that you correctly identify the positive (+) and negative (-) terminals on both the disabled and booster vehicles before connecting the cables.



Do not attach the end of the positive cable to the studs or L-shaped eyelet located above the positive (+) terminal of your vehicle's battery. High current may flow through and cause damage to the fuses.



Do not connect the end of the second cable to the negative (-) terminal of the battery to be jumped. A spark may cause an explosion of the gases that surround the battery.

---

**Note:** In the illustration, the bottom vehicle represents the booster vehicle.

# Roadside Emergencies

## Jump Starting

1. Start the engine of the booster vehicle and rev the engine moderately, or press the accelerator gently to keep your engine speed between 2000 and 3000 RPM, as shown in your tachometer.
2. Start the engine of the disabled vehicle.
3. Once the disabled vehicle has been started, run both vehicle engines for an additional three minutes before disconnecting the jumper cables.

## Removing the Jumper Cables

Remove the jumper cables in the reverse order that they were connected.

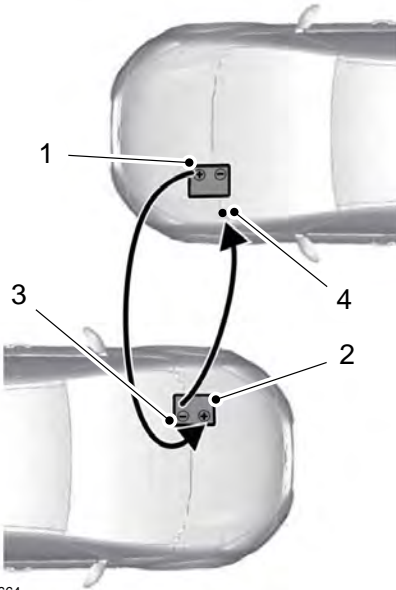

E142664

1. Connect the positive (+) jumper cable to the positive (+) terminal of the discharged battery.
2. Connect the other end of the positive (+) cable to the positive (+) terminal of the booster vehicle battery.
3. Connect the negative (-) cable to the negative (-) terminal of the booster vehicle battery.
4. Make the final connection of the negative (-) cable to an exposed metal part of the stalled vehicle's engine, away from the battery and the fuel injection system, or connect the negative (-) cable to a ground connection point if available.

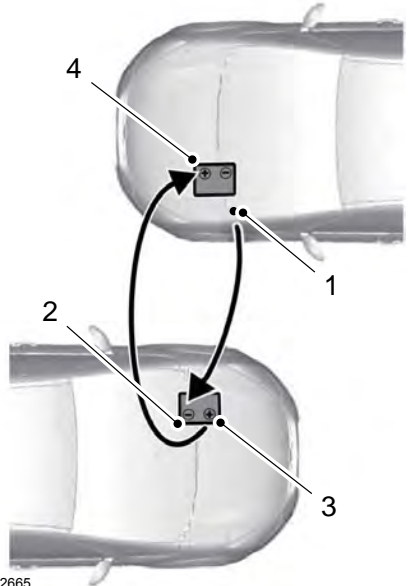

E142665

1. Remove the negative (-) jumper cable from the disabled vehicle.

# Roadside Emergencies

---

2. Remove the jumper cable on the negative (-) terminal of the booster vehicle battery.
3. Remove the jumper cable from the positive (+) terminal of the booster vehicle battery.
4. Remove the jumper cable from the positive (+) terminal of the disabled vehicle battery.
5. Allow the engine to idle for at least one minute.

## **POST-CRASH ALERT SYSTEM**

The system flashes the direction indicators and sounds the horn (intermittently) in the event of a serious impact that deploys an airbag (front, side, side curtain or Safety Canopy) or the safety belt pretensioners.

The horn and indicators will turn off when:

- You press the hazard control button.
- You press the panic button on the remote entry transmitter (if equipped).
- Your vehicle runs out of power.

# Customer Assistance

## GETTING THE SERVICES YOU NEED

Warranty repairs to your vehicle must be performed by an authorized dealer. While any authorized dealer handling your vehicle line will provide warranty service, we recommend you return to your selling authorized dealer who wants to ensure your continued satisfaction.

Please note that certain warranty repairs require special training and equipment, so not all authorized dealers are authorized to perform all warranty repairs. This means that, depending on the warranty repair needed, you may have to take your vehicle to another authorized dealer.

A reasonable time must be allowed to perform a repair after taking your vehicle to the authorized dealer. Repairs will be made using Ford or Motorcraft® parts, or remanufactured or other parts that are authorized by Ford.

### Away From Home

If you are away from home when your vehicle needs service, contact the Ford Customer Relationship Center or use the online resources listed below to find the nearest authorized dealer.

In the United States:

#### Mailing address

Ford Motor Company  
Customer Relationship Center  
P.O. Box 6248  
Dearborn, MI 48126

#### Telephone

1-800-392-3673 (FORD)  
(TDD for the hearing impaired:  
1-800-232-5952)

Additional information and resources are available online:

| Website  |
|--|
| <a href="http://www.owner.ford.com">www.owner.ford.com</a> |

These are some of the items that can be found online:

- U.S. dealer locator by Dealer Name, City/State or Zip Code.
- Owner Manuals.
- Maintenance Schedules.
- Recalls.
- Ford Extended Service Plans.
- Ford Genuine Accessories.
- Service specials and promotions.

In Canada:

#### Mailing address

Customer Relationship Centre  
Ford Motor Company of Canada, Limited  
P.O. Box 2000  
Oakville, Ontario L6K 0C8

#### Telephone

1-800-565-3673 (FORD)

| Website                                      |
|--|
| <a href="http://www.ford.ca">www.ford.ca</a> |

#### Twitter

@FordServiceCA (English Canada)  
@FordServiceQC (Quebec)

#### Additional Assistance

If you have questions or concerns, or are unsatisfied with the service you are receiving, follow these steps:

1. Contact your Sales Representative or Service Advisor at your selling or servicing authorized dealer.

# Customer Assistance

---

2. If your inquiry or concern remains unresolved, contact the Sales Manager, Service Manager or Customer Relations Manager.
3. If you require assistance or clarification on Ford Motor Company policies, please contact the Ford Customer Relationship Center.

In order to help us serve you better, please have the following information available when contacting a Customer Relationship Center:

- Vehicle Identification Number.
- Your telephone number (home and business).
- The name of the authorized dealer and city where located.
- The vehicle's current odometer reading.

In some states within the United States, you must directly notify Ford in writing before pursuing remedies under your state's warranty laws, and Ford is also allowed a final repair attempt.

Additionally, in some states within the United States, a consumer has the option of submitting a warranty dispute to the BBB Auto Line before taking action under the Magnuson-Moss Warranty Act, or to the extent allowed by state law, before pursuing replacement or repurchase remedies provided by certain state laws. This dispute handling procedure is not required prior to enforcing state created rights or other rights which are independent of the Magnuson-Moss Warranty Act or state replacement or repurchase laws.

## IN CALIFORNIA (U.S. ONLY)

California Civil Code Section 1793.2(d) requires that, if a manufacturer or its representative is unable to repair a motor vehicle to conform to the vehicle's applicable express warranty after a reasonable number of attempts, the manufacturer shall be required to either replace the vehicle with one substantially identical or repurchase the vehicle and reimburse the buyer in an amount equal to the actual price paid or payable by the consumer (less a reasonable allowance for consumer use). The consumer has the right to choose whether to receive a refund or replacement vehicle.

California Civil Code Section 1793.22(b) presumes that the manufacturer has had a reasonable number of attempts to conform the vehicle to its applicable express warranties if, within the first 18 months of ownership of a new vehicle or the first 18000 miles (29 000 km), whichever occurs first:

1. Two or more repair attempts are made on the same non-conformity likely to cause death or serious bodily injury OR
2. Four or more repair attempts are made on the same nonconformity (a defect or condition that substantially impairs the use, value or safety of the vehicle) OR
3. The vehicle is out of service for repair of nonconformities for a total of more than 30 calendar days (not necessarily all at one time).

In the case of 1 or 2 above, the consumer must also notify the manufacturer of the need for the repair of the nonconformity at the following address:

Ford Motor Company  
16800 Executive Plaza Drive  
Mail Drop 3NE-B  
Dearborn, MI 48126

# Customer Assistance

---

You are required to submit your warranty dispute to BBB AUTO LINE before asserting in court any rights or remedies conferred by California Civil Code Section 1793.22(b). You are also required to use BBB AUTO LINE before exercising rights or seeking remedies created by the Federal Magnuson-Moss Warranty Act, 15 U.S.C. sec. 2301 et seq. If you choose to seek redress by pursuing rights and remedies not created by California Civil Code Section 1793.22(b) or the Magnuson-Moss Warranty Act, resort to BBB AUTO LINE is not required by those statutes.

## **THE BETTER BUSINESS BUREAU (BBB) AUTO LINE PROGRAM (U.S. ONLY)**

Your satisfaction is important to Ford Motor Company and to your dealer. If a warranty concern has not been resolved using the three-step procedure outlined earlier in this chapter in the Getting the Services you need section, you may be eligible to participate in the BBB AUTO LINE program.

The BBB AUTO LINE program consists of two parts – mediation and arbitration. During mediation, a representative of the BBB will contact both you and Ford Motor Company to explore options for settlement of the claim. If an agreement is not reached during mediation or you do not want to participate in mediation, and if your claim is eligible, you may participate in the arbitration process. An arbitration hearing will be scheduled so that you can present your case in an informal setting before an impartial person. The arbitrator will consider the testimony provided and make a decision after the hearing.

Disputes submitted to the BBB AUTO LINE program are usually decided within forty days after you file your claim with the BBB. You are not bound by the decision, and may reject the decision and proceed to court where all findings of the BBB Auto Line dispute, and decision, are admissible in the court action. Should you choose to accept the BBB AUTO LINE decision, Ford is then bound by the decision, and must comply with the decision within 30 days of receipt of your acceptance letter.

**BBB AUTO LINE Application:** Using the information provided below, please call or write to request a program application. You will be asked for your name and address, general information about your new vehicle, information about your warranty concerns, and any steps you have already taken to try to resolve them. A Customer Claim Form will be mailed that will need to be completed, signed and returned to the BBB along with proof of ownership. Upon receipt, the BBB will review the claim for eligibility under the Program Summary Guidelines.

**You can get more information by calling BBB AUTO LINE at 1-800-955-5100, or writing to:**

**BBB AUTO LINE  
3033 Wilson Boulevard, Suite 600  
Arlington, Virginia 22201**

BBB AUTO LINE applications can also be requested by calling the Ford Motor Company Customer Relationship Center at 1-800-392-3673.

**Note:** *Ford Motor Company reserves the right to change eligibility limitations, modify procedures, or to discontinue this process at any time without notice and without obligation.*



# Customer Assistance

---

## UTILIZING THE MEDIATION/ARBITRATION PROGRAM (CANADA ONLY)

For vehicles delivered to authorized Canadian dealers. In those cases where you continue to feel that the efforts by Ford of Canada and the authorized dealer to resolve a factory-related vehicle service concern have been unsatisfactory, Ford of Canada participates in an impartial third party mediation/arbitration program administered by the Canadian Motor Vehicle Arbitration Plan (CAMVAP).

The CAMVAP program is a straight forward and relatively speedy alternative to resolve a disagreement when all other efforts to produce a settlement have failed. This procedure is without cost to you and is designed to eliminate the need for lengthy and expensive legal proceedings.

In the CAMVAP program, impartial third-party arbitrators conduct hearings at mutually convenient times and places in an informal environment. These impartial arbitrators review the positions of the parties, make decisions and, when appropriate, render awards to resolve disputes. CAMVAP decisions are fast, fair, and final as the arbitrator's award is binding on both you and Ford of Canada.

CAMVAP services are available in all Canadian territories and provinces. For more information, without charge or obligation, call your CAMVAP Provincial Administrator directly at 1-800-207-0685 or visit [www.camvap.ca](http://www.camvap.ca).

## GETTING ASSISTANCE OUTSIDE THE U.S. AND CANADA

Before exporting your vehicle to a foreign country, contact the appropriate foreign embassy or consulate. These officials can inform you of local vehicle registration regulations and where to find unleaded fuel.

If you cannot find unleaded fuel or can only get fuel with an anti-knock index lower than is recommended for your vehicle, contact our Customer Relationship Center.

The use of leaded fuel in your vehicle without proper conversion may damage the effectiveness of your emission control system and may cause engine knocking or serious engine damage. Ford Motor Company or Ford of Canada is not responsible for any damage caused by use of improper fuel. Using leaded fuel may also result in difficulty importing your vehicle back into the United States.

If your vehicle must be serviced while you are traveling or living in Asia-Pacific Region, Sub-Saharan Africa, U.S. Virgin Islands, Central America, the Caribbean, and Israel, contact the nearest authorized dealer. If the authorized dealer cannot help you, contact:

FORD MOTOR COMPANY  
Customer Relationship Center  
1555 Fairlane Drive  
Fairlane Business Park #3  
Allen Park, Michigan 48101  
U.S.A.  
Telephone: (313) 594-4857  
Fax: (313) 390-0804  
Email: [expcac@ford.com](mailto:expcac@ford.com)

## Customer Assistance

---

For customers in Guam, the Commonwealth of the Northern Mariana Islands (CNMI), America Samoa, and the U.S. Virgin Islands, please feel free to call our Toll-Free Number: (800) 841-FORD (3673).

If your vehicle must be serviced while you are traveling or living in Puerto Rico, contact the nearest authorized dealer. If the authorized dealer cannot help you, contact:

FORD MOTOR COMPANY  
Customer Relationship Center  
1555 Fairlane Drive  
Fairlane Business Park #3  
Allen Park, Michigan 48101  
U.S.A.  
Telephone: (800) 841-FORD (3673)  
FAX: (313) 390-0804  
Email: prcac@ford.com  
www.ford.com.pr

If your vehicle must be serviced while you are traveling or living in the Middle East, contact the nearest authorized dealer. If the authorized dealer cannot help you, contact:

FORD MOTOR COMPANY  
Customer Relationship Center  
1555 Fairlane Drive  
Fairlane Business Park #3  
Allen Park, Michigan 48101  
U.S.A.

**Ford:** 80004443673  
**Lincoln:** 80004441067  
**If calling from the UAE:** 80004441066  
**If calling from the Kingdom of Saudi Arabia:** 8008443673  
**If calling from Kuwait:** 22280384

FAX: +971 4 3327266  
Email: menacac@ford.com  
www.me.ford.com

If you buy your vehicle in North America and then relocate to any of the above locations, register your vehicle identification number (VIN) and new address with Ford Motor Company Export Operations & Global Growth Initiatives by emailing **expcac@ford.com**.

If you are in another foreign country, contact the nearest authorized dealer. In the event your inquiry is unresolved, communicate your concern with the dealership's Sales Manager, Service Manager or Customer Relations Manager. If you require additional assistance or clarification, please contact the respective Customer Relationship Center as previously listed.

**Customers in the U.S. should call  
1-800-392-3673.**

### ORDERING ADDITIONAL OWNER'S LITERATURE

To order the publications in this portfolio, contact Helm, Incorporated at:

HELM, INCORPORATED  
47911 Halyard Drive  
Plymouth, Michigan 48170  
Attention: Customer Service

Or to order a free publication catalog, call toll free: 1-800-782-4356

Monday-Friday 8:00 a.m. - 6:00 p.m. EST

Helm, Incorporated can also be reached by their website:

www.helminc.com

(Items in this catalog may be purchased by credit card, check or money order.)

## Customer Assistance

---

### **Obtaining a French Owner's Manual**

French Owner's Manual can be obtained from your authorized dealer or by contacting Helm, Incorporated using the contact information listed previously in this section.

### **REPORTING SAFETY DEFECTS (U.S. ONLY)**



E142557

If you believe that your vehicle has a defect which could cause a crash or could cause injury or death, you should immediately inform the National Highway Traffic Safety Administration (NHTSA) in addition to notifying Ford Motor Company.

If NHTSA receives similar complaints, it may open an investigation, and if it finds that a safety defect exists in a group of vehicles, it may order a recall and remedy campaign. However, NHTSA cannot become involved in individual problems between you, your dealer, or Ford Motor Company.

To contact NHTSA, you may call the Vehicle Safety Hotline toll-free at 1-888-327-4236 (TTY: 1-800-424-9153); go to <http://www.safercar.gov>; or write to:

Administrator  
1200 New Jersey Avenue,  
Southeast  
Washington, D.C. 20590

You can also obtain other information about motor vehicle safety from <http://www.safercar.gov>.

### **REPORTING SAFETY DEFECTS (CANADA ONLY)**

If you believe that your vehicle has a defect which could cause a crash or could cause injury or death, you should immediately inform Transport Canada and Ford of Canada.

# Customer Assistance

---

| <b>Transport Canada Contact Information</b> |  |
|---|--|
| Website                                     | <a href="http://www.tc.gc.ca/eng/motorvehiclesafety/safevehicles-defectinvestigations-index-76.htm">www.tc.gc.ca/eng/motorvehiclesafety/safevehicles-defectinvestigations-index-76.htm</a> (English) |
| Website                                     | <a href="http://www.tc.gc.ca/fra/secureteautomobile/VehiculesSecuritaires-Enquetes-index-76.htm">www.tc.gc.ca/fra/secureteautomobile/VehiculesSecuritaires-Enquetes-index-76.htm</a> (French)        |
| Phone                                       | 1-800-333-0510   |

| <b>Ford of Canada Contact Information</b> |  |
|---|--|
| Website                                   | <a href="http://www.ford.ca">www.ford.ca</a> |
| Phone                                     | 1-800-565-3673                               |

# Fuses

## FUSE SPECIFICATION CHART

### Power Distribution Box

#### WARNINGS



Always disconnect the battery before servicing high-current fuses.



To reduce risk of electrical shock, always replace the cover to the power distribution box before reconnecting the battery or refilling fluid reservoirs.

The power distribution box is located in the engine compartment. It has high-current fuses that protect your vehicle's main electrical systems from overloads.

If the battery has been disconnected and reconnected, some features will need to be reset. See **Changing the 12V Battery** (page 286).

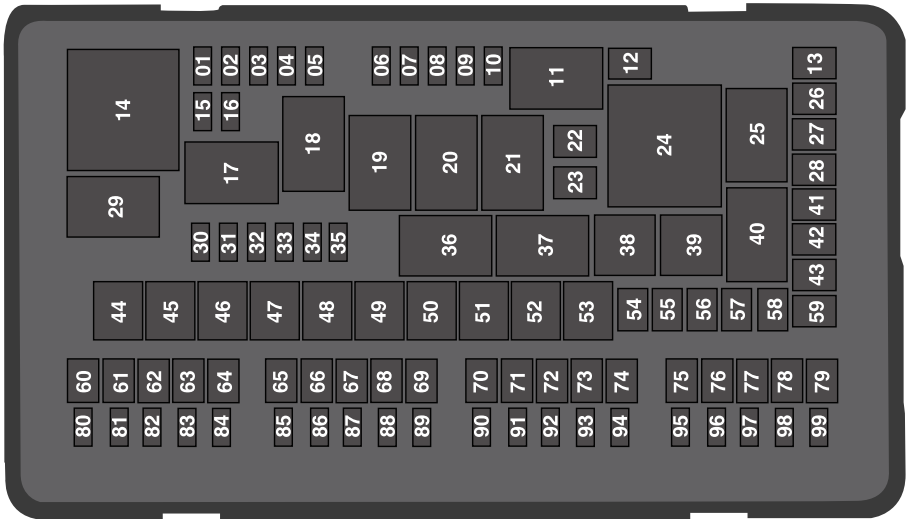

E193713

# Fuses

| Fuse or relay number | Fuse amp rating  | Protected components  |
|----------------------|------------------|---|
| 1                    | 20A <sup>1</sup> | Powertrain control module power.                                  |
| 2                    | 20A <sup>1</sup> | Engine emissions (MIL).   |
| 3                    | 20A <sup>1</sup> | A/C clutch control relay coil.<br>VACC.<br>Active grill shutters. |
| 4                    | 20A <sup>1</sup> | Ignition coils.   |
| 5                    | —                | Not used.   |
| 6                    | —                | Not used.   |
| 7                    | —                | Not used.   |
| 8                    | —                | Not used.   |
| 9                    | —                | Not used.   |
| 10                   | 15A <sup>1</sup> | Heated mirrors.   |
| 11                   | —                | Right hand side electronic cooling fan 3 relay.                   |
| 12                   | 40A <sup>2</sup> | Heated rear window.   |
| 13                   | —                | Not used.   |
| 14                   | —                | Powertrain control module relay.                                  |
| 15                   | 20A <sup>1</sup> | Horn relay power.   |
| 16                   | 10A <sup>1</sup> | A/C clutch relay power.   |
| 17                   | —                | Rear heated window and heated mirrors relay.                      |
| 18                   | —                | Rear blower motor relay.  |
| 19                   | —                | Not used.   |
| 20                   | —                | Left hand side cooling fan relay.                                 |
| 21                   | —                | Cooling fans series/parallel relay.                               |
| 22                   | 25A <sup>2</sup> | Electronic fan relay 2.   |

# Fuses

| Fuse or relay number | Fuse amp rating  | Protected components   |
|----------------------|------------------|--|
| 23                   | —                | Not used.  |
| 24                   | —                | Not used.  |
| 25                   | —                | Not used.  |
| 26                   | 30A <sup>2</sup> | Anti-lock brake system valves.   |
| 27                   | 20A <sup>2</sup> | Trailer tow battery charge relay power.  |
| 28                   | —                | Not used.  |
| 29                   | —                | Run/start relay.   |
| 30                   | —                | Not used.  |
| 31                   | 10A <sup>1</sup> | Electric power-assisted steering.  |
| 32                   | 10A <sup>1</sup> | Anti-lock brake system module.   |
| 33                   | 10A <sup>1</sup> | Powertrain control module (ISPR).  |
| 34                   | 10A <sup>1</sup> | Blind spot information system.<br>Adaptive cruise control.<br>Front view camera.<br>Rear camera. |
| 35                   | —                | Not used.  |
| 36                   | —                | Blower motor relay.  |
| 37                   | —                | Trailer tow battery charge relay.  |
| 38                   | —                | A/C compressor clutch relay.   |
| 39                   | —                | Horn relay.  |
| 40                   | —                | Not used.  |
| 41                   | 40A <sup>2</sup> | Rear blower motor.   |
| 42                   | —                | Not used.  |
| 43                   | 40A <sup>2</sup> | Front blower motor.  |
| 44                   | 50A <sup>3</sup> | Voltage quality module bus.  |
| 45                   | 40A <sup>3</sup> | Electronic fan relay 1.  |

## Fuses

| Fuse or relay number | Fuse amp rating  | Protected components                         |
|----------------------|------------------|--|
| 46                   | 30A <sup>3</sup> | Trailer tow brake controller.                |
| 47                   | —                | Not used.                                    |
| 48                   | 50A <sup>3</sup> | Body control module RPI bus.                 |
| 49                   | —                | Not used.                                    |
| 50                   | 50A <sup>3</sup> | Body control module RP2 bus.                 |
| 51                   | 50A <sup>3</sup> | Electronic fan relay 3.                      |
| 52                   | 60A <sup>3</sup> | Anti-lock brake system pump.                 |
| 53                   | —                | Not used.                                    |
| 54                   | —                | Not used.                                    |
| 55                   | —                | Not used.                                    |
| 56                   | 40A <sup>2</sup> | Power inverter.                              |
| 57                   | —                | Not used.                                    |
| 58                   | —                | Not used.                                    |
| 59                   | —                | Not used.                                    |
| 60                   | 20A <sup>2</sup> | Power point (front console bin).             |
| 61                   | —                | Not used.                                    |
| 62                   | 20A <sup>2</sup> | Power point (instrument panel).              |
| 63                   | 30A <sup>2</sup> | Fuel pump.                                   |
| 64                   | —                | Not used.                                    |
| 65                   | 20A <sup>2</sup> | Power point (2nd row) (without USB charger). |
| 66                   | —                | Not used.                                    |
| 67                   | 20A <sup>2</sup> | Power point (cargo area).                    |
| 68                   | —                | Not used.                                    |
| 69                   | 30A <sup>2</sup> | Power liftgate.                              |



# Fuses

| Fuse or relay number | Fuse amp rating  | Protected components   |
|----------------------|------------------|--|
| 70                   | 15A <sup>2</sup> | Trailer tow left-hand and right-hand stop and direction indicator lamps. |
| 71                   | —                | Not used.  |
| 72                   | 30A <sup>2</sup> | Heated/cooled seats.   |
| 73                   | 30A <sup>2</sup> | Driver seat module.<br>Driver seat power.                                |
| 74                   | 30A <sup>2</sup> | Passenger seat power.  |
| 75                   | 30A <sup>2</sup> | Front wiper motor.   |
| 76                   | —                | Not used.  |
| 77                   | —                | Not used.  |
| 78                   | 30A <sup>2</sup> | 3rd row power folding seat module relay.                                 |
| 79                   | 30A <sup>2</sup> | Starter relay.   |
| 80                   | —                | Not used.  |
| 81                   | 10A <sup>1</sup> | Trailer tow back-up lamp relay.  |
| 82                   | —                | Not used.  |
| 83                   | 10A <sup>1</sup> | Brake on/off switch.   |
| 84                   | —                | Not used.  |
| 85                   | 5A <sup>1</sup>  | 2nd row USB charger (if equipped).                                       |
| 86                   | —                | Not used.  |
| 87                   | —                | Not used.  |
| 88                   | —                | Not used.  |
| 89                   | —                | Not used.  |
| 90                   | —                | Not used.  |
| 91                   | —                | Not used.  |
| 92                   | 15A <sup>1</sup> | Multi-contour seat module relay.   |

# Fuses

| Fuse or relay number | Fuse amp rating  | Protected components                        |
|----------------------|------------------|---|
| 93                   | 10A <sup>1</sup> | Alternator sense.                           |
| 94                   | 15A <sup>1</sup> | Rear washer relay.                          |
| 95                   | 15A <sup>1</sup> | Rear wiper relay.                           |
| 96                   | 10A <sup>1</sup> | Powertrain control module relay coil power. |
| 97                   | 5A <sup>1</sup>  | Rain sensor.                                |
| 98                   | 20A <sup>1</sup> | 2nd row seat motors.                        |
| 99                   | 20A <sup>1</sup> | Trailer tow parking lamp relay.             |

<sup>1</sup>Micro fuse.

<sup>2</sup>M-type fuse.

<sup>3</sup>J-type fuse.

## Passenger Compartment Fuse Panel

The fuse panel is located under the instrument panel to the left of the steering column.

**Note:** *It may be easier to access the fuse panel if you remove the finish trim piece.*

# Fuses

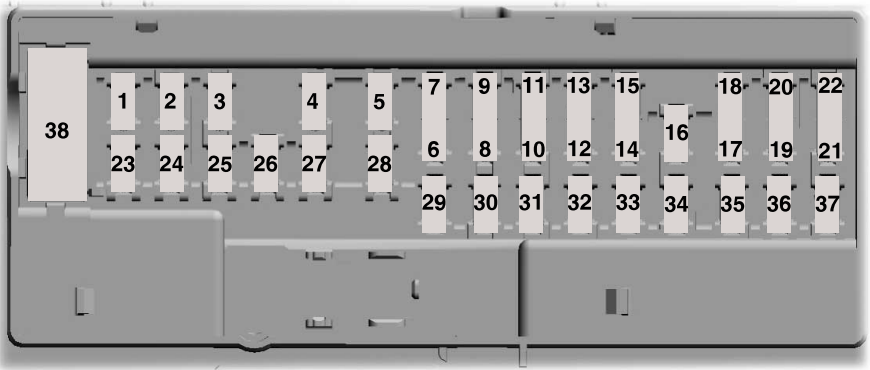

E145984

| Fuse or relay number | Fuse amp rating   | Protected components                                      |
|----------------------|-------------------|---|
| 1                    | 10A <sup>1</sup>  | Demand lamps.<br>Battery saver.                           |
| 2                    | 7.5A <sup>1</sup> | Memory seat switch (lumbar power).                        |
| 3                    | 20A <sup>1</sup>  | Driver unlock relay.                                      |
| 4                    | 5A <sup>1</sup>   | Aftermarket electronic brake controller.                  |
| 5                    | 20A <sup>1</sup>  | Rear heated seat module.                                  |
| 6                    | —                 | Not used.   |
| 7                    | —                 | Not used.   |
| 8                    | —                 | Not used.   |
| 9                    | —                 | Not used.   |
| 10                   | 5A <sup>2</sup>   | Securicode™ keyless entry keypad.<br>Hands free liftgate. |
| 11                   | 5A <sup>2</sup>   | Rear climate control module.                              |
| 12                   | 7.5A <sup>2</sup> | Front climate control module.                             |

## Fuses

| Fuse or relay number | Fuse amp rating   | Protected components   |
|----------------------|-------------------|--|
| 13                   | 7.5A <sup>2</sup> | Instrument cluster.<br>Smart data link.<br>Steering column control module.   |
| 14                   | —                 | Not used.  |
| 15                   | 10A <sup>2</sup>  | Smart datalink connector power.<br>Heads up display.   |
| 16                   | —                 | Not used.  |
| 17                   | 5A <sup>2</sup>   | Electronic finish panel.   |
| 18                   | 5A <sup>2</sup>   | Push button start switch.<br>Ignition switch.<br>Key inhibit.  |
| 19                   | 7.5A <sup>2</sup> | Transmission control switch (tow haul).  |
| 20                   | —                 | Not used.  |
| 21                   | 5A <sup>2</sup>   | Terrain management switch.<br>Heads up display.<br>Humidity sensor.  |
| 22                   | 5A <sup>2</sup>   | Occupant classification sensor.  |
| 23                   | 10A <sup>1</sup>  | Delayed accessory power.<br>Power windows.<br>Moonroof.<br>Folding mirror relay.<br>DC inverter.<br>Window/moonroof switch illumination. |
| 24                   | 20A <sup>1</sup>  | Central lock relay.  |
| 25                   | 30A <sup>1</sup>  | Left-hand front smart window motor.<br>Door zone module.   |
| 26                   | 30A <sup>1</sup>  | Right-hand front smart window motor.<br>Door zone module.  |
| 27                   | 30A <sup>1</sup>  | Moonroof.  |
| 28                   | 20A <sup>1</sup>  | Sony amplifier - 10 channel.   |
| 29                   | 30A <sup>1</sup>  | Sony amplifier - 14 channel.   |

# Fuses

| Fuse or relay number | Fuse amp rating  | Protected components   |
|----------------------|------------------|--|
| 30                   | —                | Not used.  |
| 31                   | —                | Not used.  |
| 32                   | 10A <sup>1</sup> | SYNC.<br>GPS module.<br>Display.<br>Radio frequency receiver.                          |
| 33                   | 20A <sup>1</sup> | Radio.   |
| 34                   | 30A <sup>1</sup> | Run/start relay.   |
| 35                   | 5A <sup>1</sup>  | Restrain control module.   |
| 36                   | 15A <sup>1</sup> | Lane departure warning module.<br>Auto high beam.<br>EC mirrors.<br>Rear heated seats. |
| 37                   | 20A <sup>1</sup> | Heated steering wheel.   |
| 38                   | 30A <sup>3</sup> | Left-hand front window motor.<br>Rear power window motors.                             |

<sup>1</sup>Micro fuse.

<sup>2</sup>Dual micro fuse.

<sup>3</sup>Circuit breaker.

## CHANGING A FUSE

### Fuses

#### WARNING



Always replace a fuse with one that has the specified amperage rating. Using a fuse with a higher amperage rating can cause severe wire damage and could start a fire.



E217331

If electrical components in the vehicle are not working, a fuse may have blown. Blown fuses are identified by a broken wire within the fuse. Check the appropriate fuses before replacing any electrical components.

# Fuses

## Fuse Types

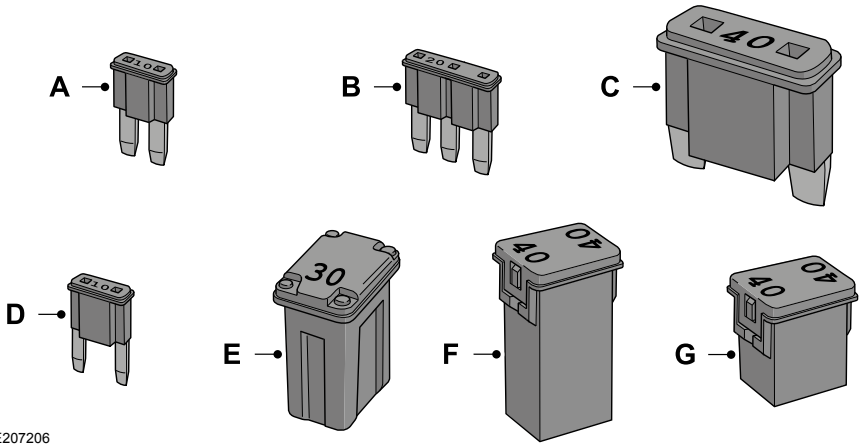

E207206

| Callout | Fuse Type          |
|---------|--------------------|
| A       | Micro 2            |
| B       | Micro 3            |
| C       | Maxi               |
| D       | Mini               |
| E       | M Case             |
| F       | J Case             |
| G       | J Case Low Profile |

# Maintenance

## GENERAL INFORMATION

Have your vehicle serviced regularly to help maintain its roadworthiness and resale value. There is a large network of authorized dealers that are there to help you with their professional servicing expertise. We believe that their specially trained technicians are best qualified to service your vehicle properly and expertly. They are supported by a wide range of highly specialized tools developed specifically for servicing your vehicle.

If your vehicle requires professional service, an authorized dealer can provide the necessary parts and service. Check your warranty information to find out which parts and services are covered.

Use only recommended fuels, lubricants, fluids and service parts conforming to specifications. Motorcraft® parts are designed and built to provide the best performance in your vehicle.

## Precautions

- Do not work on a hot engine.
- Make sure that nothing gets caught in moving parts.
- Do not work on a vehicle with the engine running in an enclosed space, unless you are sure you have enough ventilation.
- Keep all open flames and other burning material (such as cigarettes) away from the battery and all fuel related parts.

## Working with the Engine Off

1. Set the parking brake and shift to park (P).
2. Switch off the engine.
3. Block the wheels.

## Working with the Engine On

### WARNING



To reduce the risk of vehicle damage and/or personal burn injuries, do not start your engine with the air cleaner removed and do not remove it while the engine is running.

1. Set the parking brake and shift to park (P).
2. Block the wheels.

## OPENING AND CLOSING THE HOOD

### Opening the Hood

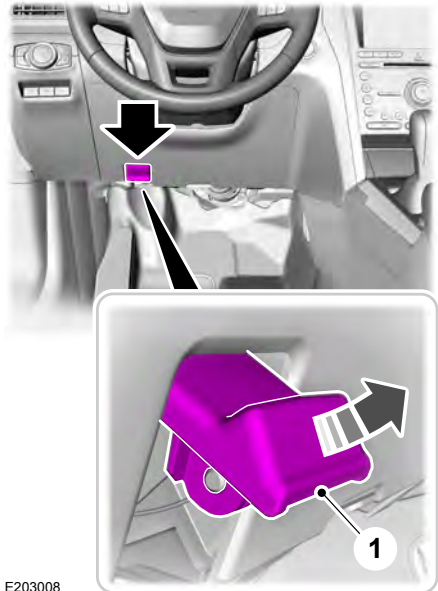

E203008

# Maintenance

1. Inside the vehicle, pull the hood release handle located under the left-hand side of the instrument panel.
2. Slightly lift the hood.

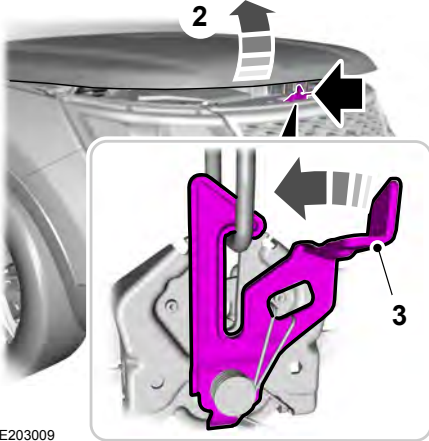

E203009

3. Move the catch to the left.

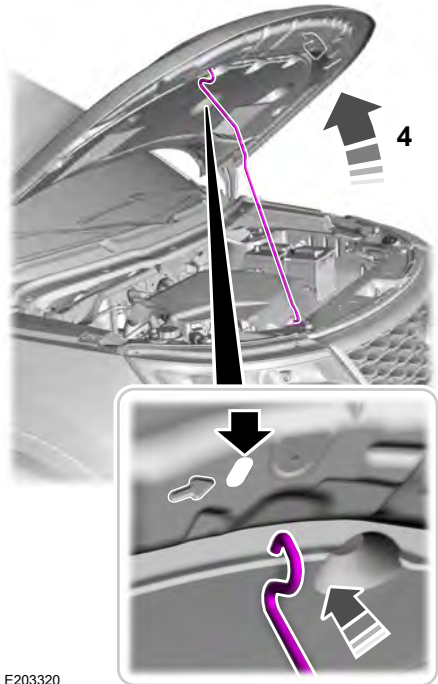

E203320

4. Open the hood. Support the hood with the strut.

## Closing the Hood

1. Remove the hood strut from the catch and secure it correctly after use.
2. Lower the hood and allow it to drop under its own weight for the last 8–12 in (20–30 cm).

**Note:** Make sure that the hood is correctly closed.



# Maintenance

## UNDER HOOD OVERVIEW - 2.3L ECOBOOST™

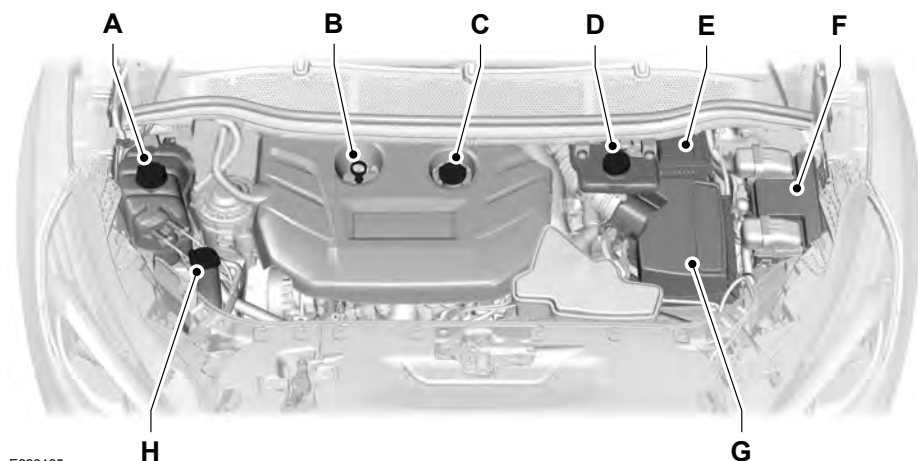

E223185

- A Engine coolant reservoir. See **Engine Coolant Check** (page 280).
- B Engine oil dipstick. See **Engine Oil Dipstick** (page 278).
- C Engine oil filler cap. See **Engine Oil Check** (page 278).
- D Brake fluid reservoir. See **Brake Fluid Check** (page 285).
- E Battery. See **Changing the 12V Battery** (page 286).
- F Engine compartment fusebox. See **Fuse Specification Chart** (page 263).
- G Air filter assembly. See **Changing the Engine Air Filter** (page 296).
- H Windshield washer fluid reservoir. See **Washer Fluid Check** (page 286).

# Maintenance

## UNDER HOOD OVERVIEW - 3.5L ECOBOOST™

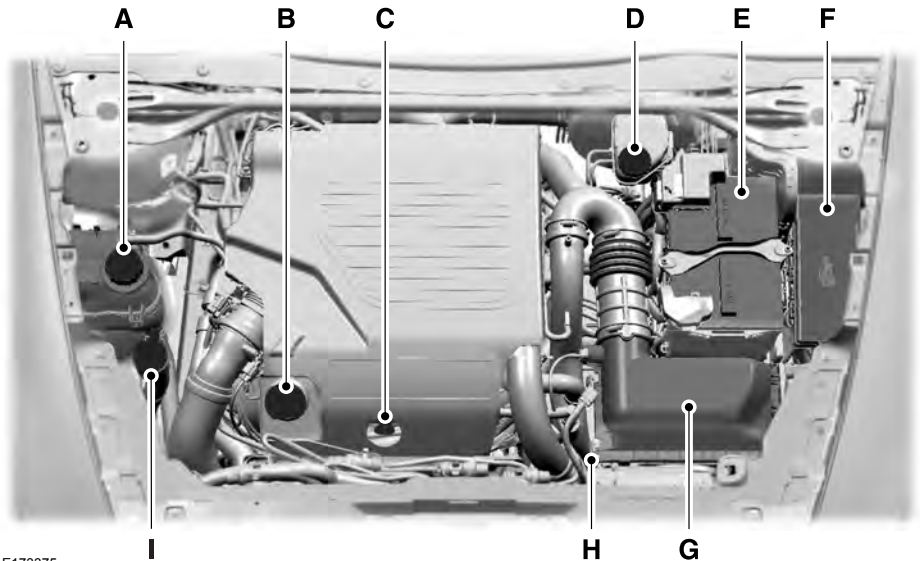

E173375

- A. Engine coolant reservoir. See **Engine Coolant Check** (page 280).
- B. Engine oil filler cap. See **Engine Oil Check** (page 278).
- C. Engine oil dipstick. See **Engine Oil Dipstick** (page 278).
- D. Brake fluid reservoir. See **Brake Fluid Check** (page 285).
- E. Battery. See **Changing the 12V Battery** (page 286).
- F. Engine compartment fuse box. See **Fuses** (page 263).
- G. Air filter assembly. See **Changing the Engine Air Filter** (page 296).
- H. Automatic transmission dipstick. See **Automatic Transmission Fluid Check** (page 284).
- I. Washer fluid reservoir. See **Washer Fluid Check** (page 286).

# Maintenance

## UNDER HOOD OVERVIEW - 3.5L DURATEC

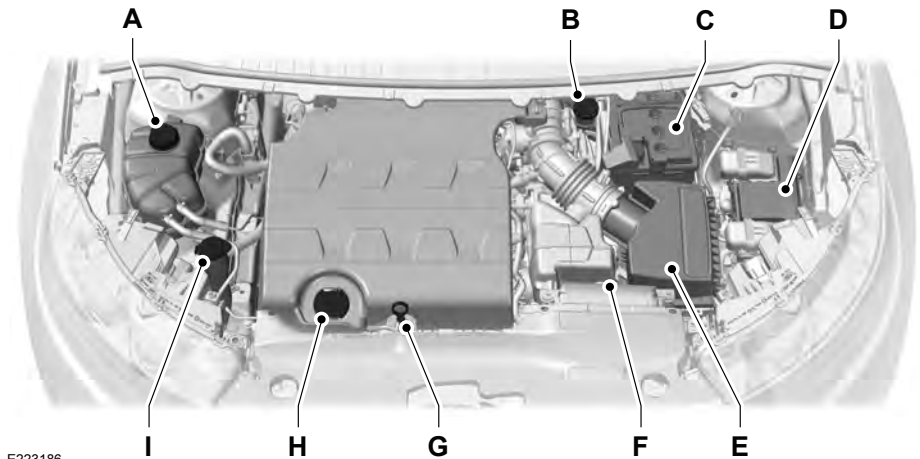

- A Engine coolant reservoir. See **Engine Coolant Check** (page 280).
- B Brake fluid reservoir. See **Brake Fluid Check** (page 285).
- C Battery. See **Changing the 12V Battery** (page 286).
- D Engine compartment fusebox. See **Fuse Specification Chart** (page 263).
- E Air filter assembly. See **Changing the Engine Air Filter** (page 296).
- F Automatic transmission fluid dipstick. See **Automatic Transmission Fluid Check** (page 284).
- G Engine oil dipstick. See **Engine Oil Dipstick** (page 278).
- H Engine oil filler cap. See **Engine Oil Check** (page 278).
- I Windshield washer fluid reservoir. See **Washer Fluid Check** (page 286).

# Maintenance

## ENGINE OIL DIPSTICK - 2.3L ECOBOOST™



E161560

- A Minimum.
- B Maximum.

## ENGINE OIL DIPSTICK - 3.5L DURATEC/3.5L ECOBOOST™

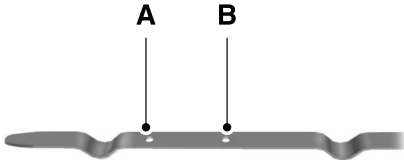

E146429

- A MIN
- B MAX

## ENGINE OIL CHECK

To check the engine oil level consistently and accurately, do the following:

1. Make sure the parking brake is on. Make sure the transmission is in park (P) or neutral (N).
2. Run the engine until it reaches normal operating temperature.
3. Make sure that your vehicle is on level ground.
4. Switch the engine off and wait 15 minutes for the oil to drain into the oil pan. Checking the engine oil level too soon after you switch the engine off may result in an inaccurate reading.
5. Open the hood. See **Opening and Closing the Hood** (page 273).
6. Remove the dipstick and wipe it with a clean, lint-free cloth. See **Under Hood Overview** (page 275).
7. Replace the dipstick and remove it again to check the oil level. See **Engine Oil Dipstick** (page 278).
8. Make sure that the oil level is between the maximum and minimum marks. If the oil level is at the minimum mark, add oil immediately. See **Capacities and Specifications** (page 338).
9. If the oil level is correct, replace the dipstick and make sure it is fully seated.

**Note:** Do not remove the dipstick when the engine is running.

**Note:** If the oil level is between the maximum and minimum marks, the oil level is acceptable. Do not add oil.

**Note:** The oil consumption of new engines reaches its normal level after approximately 3,100 mi (5,000 km).

## Adding Engine Oil

### WARNING



Do not remove the filler cap when the engine is running.

# Maintenance

Do not use supplemental engine oil additives because they are unnecessary and could lead to engine damage that may not be covered by the vehicle Warranty.



E142732

Only use oils certified for gasoline engines by the American Petroleum Institute (API). An oil with this trademark symbol conforms to the current engine and emission system protection standards and fuel economy requirements of the International Lubricants Specification Advisory Committee (ILSAC), comprised of U.S. and Japanese automobile manufacturers.

To top up the engine oil level do the following:

Clean the area surrounding the engine oil filler cap before you remove it.

1. Remove the engine oil filler cap. See **Under Hood Overview** (page 275). Turn it counterclockwise and remove it.
2. Add engine oil that meets the correct specification. See **Capacities and Specifications** (page 338). You may have to use a funnel to pour the engine oil into the opening.
3. Recheck the oil level.
4. If the oil level is correct, replace the dipstick and make sure it is fully seated.

5. Replace the engine oil filler cap. Turn it clockwise until you feel a strong resistance.

**Note:** Do not add oil further than the maximum mark. Oil levels above the maximum mark may cause engine damage.

**Note:** Make sure you install the oil filler cap correctly.

**Note:** Soak up any spillage with an absorbent cloth immediately.

## OIL CHANGE INDICATOR RESET

Use the information display controls on the steering wheel to reset the oil change indicator.

### From the main menu scroll to:

| Message          | Action and description   |
|------------------|--|
| Settings         | Press the right arrow button, then from this menu scroll to the following message.                                       |
| Vehicle          | Press the right arrow button, then from this menu scroll to the following message.                                       |
| Oil Life         | Press the right arrow button, then from this menu scroll to the following message.                                       |
| Hold OK to Reset | Press and hold the <b>OK</b> button until the instrument cluster displays the following message.<br><br>Reset Successful |
|                  | When the oil change indicator resets the instrument cluster displays 100%.<br><br>Remaining Life<br>{00}%                |

# Maintenance

| Message | Action and description  |
|---------|---|
|         | If the instrument cluster displays one of the following messages, repeat the process.<br><br>Not Reset<br><br>Reset Cancelled |

**Note:** Coolant expands when it is hot. The level may extend beyond the **MAX** mark.

**Note:** If the level is at the **MIN** mark, below the **MIN** mark, or empty, add coolant immediately.

Maintain coolant concentration within 48% to 50%, which equates to a freeze point between -30°F (-34°C) and -34°F (-37°C).

**Note:** For best results, coolant concentration should be tested with a refractometer such as Robinair® Coolant and Battery Refractometer 75240. We do not recommend the use of hydrometers or coolant test strips for measuring coolant concentrations.

**Note:** Automotive fluids are not interchangeable. Do not use engine coolant, antifreeze or windshield washer fluid outside of its specified function and vehicle location.

## ENGINE COOLANT CHECK

### WARNINGS

 Do not add engine coolant when the engine is hot. Steam and scalding liquids released from a hot cooling system can burn you badly. Also, spilling coolant on hot engine parts can burn you.

 Do not put engine coolant in the windshield washer fluid container. If sprayed on the windshield, engine coolant could make it difficult to see through the windshield.

 To reduce the risk of personal injury, make sure the engine is cool before unscrewing the coolant pressure relief cap. The cooling system is under pressure. Steam and hot liquid can come out forcefully when you loosen the cap slightly.

 Do not add coolant further than the **MAX** mark.

## Checking the Engine Coolant

When the engine is cold, check the concentration and level of the engine coolant at the intervals listed in the scheduled maintenance information. See **Scheduled Maintenance** (page 483).

**Note:** Make sure that the coolant level is between the **MIN** and **MAX** marks on the coolant reservoir.

## Adding Engine Coolant

**Note:** Do not use stop leak pellets, cooling system sealants or additives as they can cause damage to the engine cooling or heating systems. Your warranty may not cover these damages.

**Note:** During normal vehicle operation, the coolant may change color from orange to pink or light red. As long as the coolant is clear and uncontaminated, this color change does not indicate the coolant has degraded nor does it require the coolant to be drained, the system to be flushed, or the coolant to be replaced.

Do not mix different colors or types of coolant in your vehicle. Mixing of engine coolants may harm your engine's cooling system. Use prediluted engine coolant meeting the correct specification. The use of an incorrect coolant may harm the engine or cooling system components and may not be covered by the vehicle Warranty.

# Maintenance

---

In case of emergency, you can add a large amount of water without engine coolant in order to reach a vehicle service location. In this instance, qualified personnel:

1. Must drain the cooling system.
2. Chemically clean the cooling system with Motorcraft Premium Cooling System Flush.
3. Refill with engine coolant as soon as possible.

Water alone, without engine coolant, can cause engine damage from corrosion, overheating or freezing.

Do not use the following as a coolant substitute:

- Alcohol.
- Methanol.
- Brine.
- Any engine coolant mixed with alcohol or methanol antifreeze or coolant.

Alcohol and other liquids can cause engine damage from overheating or freezing.

Do not add extra inhibitors or additives to the coolant. These can be harmful and compromise the corrosion protection of the engine coolant.

When adding coolant:

1. Unscrew the cap slowly. Any pressure will escape as you unscrew the cap.
2. Add prediluted engine coolant meeting the correct specification.
3. Check the coolant level in the coolant reservoir the next few times you drive your vehicle.
4. If necessary, add enough prediluted engine coolant to bring the coolant level to the proper level.

## Recycled Engine Coolant

We do not recommend the use of recycled engine coolant as an approved recycling process is not yet available.

Used engine coolant should be disposed of in an appropriate manner. Follow your community's regulations and standards for recycling and disposing of automotive fluids.

## Severe Climates

If you drive in extremely cold climates:

- It may be necessary to have an authorized dealer increase the coolant concentration above 50%.
- A coolant concentration of 60% provides improved freeze point protection. Engine coolant concentrations above 60% decrease the overheat protection characteristics of the engine coolant and may cause engine damage.

If you drive in extremely hot climates:

- It may be necessary to have an authorized dealer decrease the coolant concentration to 40%.
- A coolant concentration of 40% provides improved overheat protection. Engine coolant concentrations below 40% decrease the freeze and corrosion protection characteristics of the engine coolant and may cause engine damage.

Vehicles driven year-round in non-extreme climates should use prediluted engine coolant for optimum cooling system and engine protection.

# Maintenance

## What You Should Know About Fail-Safe Cooling

If you deplete the engine coolant supply, fail-safe cooling allows you to temporarily drive your vehicle before you incur incremental component damage. The fail-safe distance depends on ambient temperatures, vehicle load and terrain.

### How Fail-Safe Cooling Works

If the engine begins to overheat, the engine coolant temperature gauge will move to the red (hot) area and:



the coolant temperature warning light will illuminate



the service engine soon indicator will illuminate.

If the engine reaches a preset over-temperature condition, the engine automatically switches to alternating cylinder operation. Each disabled cylinder acts as an air pump and cools the engine.

When this occurs, your vehicle will still operate. However:

- The engine power will be limited.
- This will disable the air conditioning system.

Continued operation increases the engine temperature, causing the engine to completely shut down. Your steering and braking effort increases in this situation.

When the engine temperature cools, you can re-start your engine. Take your vehicle to an authorized dealer as soon as possible to minimize engine damage.

## When Fail-Safe Mode Is Activated

### WARNINGS



Fail-safe mode is for use during emergencies only. Operate your vehicle in fail-safe mode only as long as necessary to bring your vehicle to rest in a safe location and seek immediate repairs. When in fail-safe mode, your vehicle will have limited power, will not be able to maintain high-speed operation, and may completely shut down without warning, potentially losing engine power, power steering assist, and power brake assist, which may increase the possibility of a crash resulting in serious injury.



Never remove the coolant reservoir cap while the engine is running or hot.

You have limited engine power when in the fail-safe mode, so drive your vehicle with caution. Your vehicle will not maintain high-speed operation and the engine will operate poorly.

Remember that the engine is capable of automatically shutting down to prevent engine damage. In this situation:

1. Pull off the road as soon as safely possible and switch off the engine.
2. Tow your vehicle to an authorized dealer.
3. If this is not possible, wait a short period for the engine to cool.
4. Check the coolant level and add if low.
5. Re-start the engine and drive your vehicle to an authorized dealer.

**Note:** *Driving your vehicle without repair increases the chance of engine damage. Contact an authorized dealer as soon as possible.*



# Maintenance

## Engine Fluid Temperature Management (If Equipped)

### WARNINGS



To reduce the risk of crash and injury, be prepared that the vehicle speed may reduce and the vehicle may not be able to accelerate with full power until the fluid temperatures reduce.



Never remove the coolant reservoir cap while the engine is running or hot.

Your vehicle can pull a trailer, but because of the added load, your vehicle's engine may temporarily reach higher temperatures during severe operating conditions such as ascending a long or steep grade while pulling a trailer in high temperatures.

At this time, you may notice your engine coolant temperature gauge needle move toward the **H** and the **POWER REDUCED TO LOWER TEMP** message may appear in the information display.

You may notice a reduction in vehicle speed caused by reduced engine power. In order to manage the engine fluid temperatures, your vehicle may enter this mode if certain high-temperature and high-load conditions take place. The amount of speed reduction depends on many factors such as vehicle loading, towing, grade and ambient temperature. If this occurs, there is no need to pull off the road. You can continue to drive your vehicle while this message is active.

The air conditioning may also cycle on and off during severe operating conditions to protect overheating of the engine. When the engine coolant temperature decreases to a normal operating temperature, the air conditioning will turn on once again.

If the engine coolant temperature gauge moves fully into the red (hot) area, or if the coolant temperature warning or service engine soon messages appear in your information display:

1. Pull off the road as soon as safely possible and shift the transmission into **P**.
2. Leave the engine running until the coolant temperature gauge needle moves away from the red (hot) area. After several minutes, if the temperature does not drop, follow the remaining steps.
3. Switch the engine off and wait for it to cool before checking the coolant level.
4. If the coolant level is normal, restart your engine and continue.
5. If the coolant is low, add coolant, and restart the engine. See **Adding Engine Coolant** or **How Fail-Safe Cooling Works** in this chapter for more information.

## AUTOMATIC TRANSMISSION FLUID CHECK - 2.3L ECOBOOST™

**Note:** *Transmission fluid should be checked by an authorized dealer. If required, fluid should be added by an authorized dealer.*

The automatic transmission does not have a transmission fluid dipstick.

Have an authorized dealer check and change the transmission fluid at the correct service interval. See **Scheduled Maintenance** (page 483). Your transmission does not consume fluid. However, the fluid level should be checked if the transmission is not working properly, (i.e., if the transmission slips or shifts slowly) or if you notice some sign of fluid leakage.

# Maintenance

Do not use supplemental transmission fluid additives, treatments or cleaning agents. The use of these materials may affect transmission operation and result in damage to internal transmission components.

## AUTOMATIC TRANSMISSION FLUID CHECK - 3.5L DURATEC/ 3.5L ECOBOOST™

### WARNING



Do not use supplemental transmission fluid additives, treatments or cleaning agents. The use of these materials may affect transmission operation and result in damage to internal transmission components.

The transmission does not consume fluid. However, if the transmission slips or shifts slowly you should check the fluid level. If you notice a sign of leaking fluid, contact an authorized dealer.

### Checking the Transmission Fluid Level

### WARNING



The dipstick and surrounding components are hot. Use gloves when moving components and checking the transmission fluid level. Failure to follow this warning could result in serious personal injury.

Only check the transmission fluid level when the engine is at normal operating temperature 179°F (82°C)-199°F (93°C). Normal operating temperature is reached after driving approximately 20 mi (30 km).

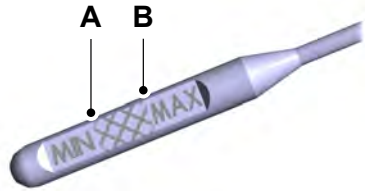

E190273

- A Minimum.  
B Maximum.

**Note:** Check the fluid level with the engine running and the transmission in park (P).

1. Make sure that your vehicle is on level ground.
2. Rotate the automatic transmission fluid cap in a counterclockwise direction. See **Under Hood Overview** (page 277).
3. Remove the cap and dipstick and wipe it with a clean, lint-free cloth. Replace the cap and dipstick and remove it again to check the fluid level.
4. Make sure that the fluid level is between the MIN and the MAX marks. If the fluid level is at the MIN mark, add fluid immediately. See **Adding Transmission Fluid**.
5. Replace the automatic transmission fluid cap and dipstick. Turn it clockwise until you feel a strong resistance.

### Low Fluid Level

If the fluid level is within the minimum range (below point A) add the correct specification fluid to be within the hash mark area. See **Capacities and Specifications** (page 341).

**Note:** If the fluid level is below the minimum range do not drive your vehicle. A low fluid level can damage the transmission.

# Maintenance

## Correct Fluid Level

If the fluid level is within the hash mark area (between points A and B) do not add any fluid.

## High Fluid Level

If the fluid level is above the maximum range (above point B) fluid may need to be removed. High fluid levels may be caused by a overheating condition. If you have operated your vehicle at high speeds, towing a trailer or in city traffic during hot weather, allow your vehicle to cool for a minimum of 30 minutes before rechecking the level.

**Note:** An overfill condition can damage the transmission.

## Adding Transmission Fluid\*

1. Rotate the automatic transmission fluid cap in a counterclockwise direction.
2. Remove the cap and dipstick and wipe it with a clean, lint-free cloth.
3. Add fluid that meets the Ford specifications. See **Capacities and Specifications** (page 341). Pour the fluid directly into the automatic transmission fluid cap and dipstick hole.
4. Replace the cap and dipstick and remove it again to check the fluid level.
5. Make sure that the fluid level is between the MIN and the MAX marks.
6. Replace the automatic transmission fluid cap and dipstick. Turn it clockwise until you feel a strong resistance.

## \*Vehicles With EcoBoost Engine

### WARNING



Do not run the engine with the air filter disconnected.

1. Loosen the clamp holding the air filter assembly to the rubber hose.
2. Remove the air filter assembly securing bolts.
3. Lift the air filter assembly to disengage the locating pins.
4. Rotate the air filter assembly slightly in a counterclockwise direction.
5. Check the transmission fluid level.
6. Install the air filter assembly in reverse order. Tighten the air filter assembly securing bolts until you feel a strong resistance.

## BRAKE FLUID CHECK

### WARNINGS



Do not use any fluid other than the recommended brake fluid as this will reduce brake efficiency. Use of incorrect fluid could result in the loss of vehicle control, serious personal injury or death.



Only use brake fluid from a sealed container. Contamination with dirt, water, petroleum products or other materials may result in brake system damage or failure. Failure to adhere to this warning could result in the loss of vehicle control, serious personal injury or death.



Do not allow the fluid to touch your skin or eyes. If this happens, rinse the affected areas immediately with plenty of water and contact your physician.



A fluid level between the **MAX** and **MIN** lines is within the normal operating range and there is no need to add fluid. A fluid level not in the normal operating range could compromise the performance of the system. Have your vehicle checked immediately.

# Maintenance



E170684

To avoid fluid contamination, the reservoir cap must remain in place and fully tight, unless you are adding fluid.

Only use fluid that meets Ford specifications.

## POWER STEERING FLUID CHECK

Your vehicle is equipped with an electric power steering (EPS) system. There is no fluid reservoir to check or fill.

## WASHER FLUID CHECK

### WARNING

 If you operate your vehicle in temperatures below 40°F (5°C), use washer fluid with antifreeze protection. Failure to use washer fluid with antifreeze protection in cold weather could result in impaired windshield vision and increase the risk of injury or accident.

**Note:** *The front and rear washer systems are supplied from the same reservoir.*

Add fluid to fill the reservoir if the level is low. Only use a washer fluid that meets Ford specifications.

State or local regulations on volatile organic compounds may restrict the use of methanol, a common windshield washer antifreeze additive. Washer fluids containing non-methanol antifreeze agents should be used only if they provide cold weather protection without damaging the vehicle's paint finish, wiper blades or washer system.

## FUEL FILTER

Your vehicle is equipped with a lifetime fuel filter that is integrated with the fuel tank. Regular maintenance or replacement is not needed.

## CHANGING THE 12V BATTERY

### WARNINGS

 Batteries normally produce explosive gases which can cause personal injury. Therefore, do not allow flames, sparks or lighted substances to come near the battery. When working near the battery, always shield your face and protect your eyes. Always provide correct ventilation.

 When lifting a plastic-cased battery, excessive pressure on the end walls could cause acid to flow through the vent caps, resulting in personal injury and damage to the vehicle or battery. Lift the battery with a battery carrier or with your hands on opposite corners.

# Maintenance

## WARNINGS



Keep batteries out of reach of children. Batteries contain sulfuric acid. Avoid contact with skin, eyes or clothing. Shield your eyes when working near the battery to protect against possible splashing of acid solution. In case of acid contact with skin or eyes, flush immediately with water for a minimum of 15 minutes and get prompt medical attention. If acid is swallowed, call a physician immediately.



Battery posts, terminals and related accessories contain lead and lead compounds. Wash hands after handling.

Your vehicle has a Motorcraft® maintenance-free battery which normally does not require additional water during its life of service.

**Note:** *If your vehicle's battery has a cover or shield, make sure it is reinstalled after the battery has been cleaned or replaced.*

**Note:** *See an authorized dealer for low voltage battery access, testing, or replacement.*

When a low voltage battery replacement is necessary, see an authorized dealer to replace the low voltage battery with a Ford recommended replacement low voltage battery that matches the electrical requirements of the vehicle.

To ensure proper operation of the battery management system (BMS), do not allow a technician to connect any electrical device ground connection directly to the low voltage battery negative post. A connection at the low voltage battery negative post can cause inaccurate measurements of the battery condition and potential incorrect system operation.

**Note:** *If a person adds electrical or electronic accessories or components to the vehicle, the accessories or components may adversely affect the low voltage battery performance and durability and may also affect the performance of other electrical systems in the vehicle.*

For longer, trouble-free operation, keep the top of the battery clean and dry. Also, make certain the battery cables are always tightly fastened to the battery terminals.

If you see any corrosion on the battery or terminals, remove the cables from the terminals and clean with a wire brush. You can neutralize the acid with a solution of baking soda and water.

When a battery replacement is required, the battery should only be replaced with a Ford recommended replacement battery that matches the electrical requirements of the vehicle.

Because your vehicle's engine is electronically-controlled by a computer, some engine control settings are maintained by power from the low voltage battery. Some engine computer settings, like the idle trim and fuel trim strategy, optimize the driveability and performance of the engine. Some other computer settings, like the clock and radio station presets, are also maintained in memory by power from the low voltage battery. When a technician disconnects and connects the low voltage battery, these settings are erased. Complete the following procedure in order to restore the settings:

1. With the vehicle at a complete stop, set the parking brake.
2. Shift into park (P).
3. Switch off all accessories.
4. Fully press the brake pedal and start the vehicle.

# Maintenance

5. Run the engine until it reaches normal operating temperature. While the engine is warming up, complete the following: Reset the clock. See **Audio System** (page 351). Reset the power windows bounce-back feature. See **Windows and Mirrors** (page 86). Reset the radio station presets. See **Audio System** (page 351).
6. Allow the engine to idle for at least one minute. If the engine turns off, press the accelerator pedal to start the engine.
7. While the engine is running, press the brake pedal and shift into neutral (N).
8. Allow the engine to run for at least one minute by pressing on the accelerator pedal.
9. Drive the vehicle at least 12 mi (20 km) to completely relearn the idle and fuel trim strategy.

**Note:** *If you do not allow the engine to relearn the idle and fuel trim strategy, the idle quality of your vehicle may be adversely affected until the engine computer eventually relearns the idle trim and fuel trim strategy.*

Make sure that you dispose of old batteries in an environmentally friendly way. Seek advice from your local authority about recycling old batteries.

## CHECKING THE WIPER BLADES



E142463

Run the tip of your fingers over the edge of the blade to check for roughness.

Clean the wiper blades with washer fluid or water applied with a soft sponge or cloth.

## CHANGING THE WIPER BLADES

You can improve poor wiper quality by cleaning the wiper blades and the windshield.

Replace the wiper blades at least annually for optimum performance.

### Front Wiper Blades

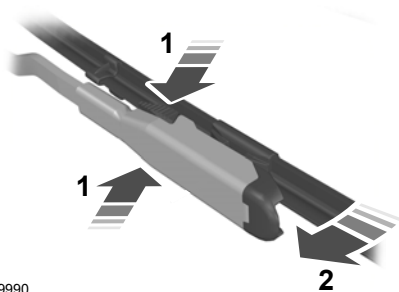

E129990

1. Lift the wiper arm and then press the wiper blade locking buttons together.

**Note:** *Do not hold the wiper blade when lifting the wiper arm.*

**Note:** *Make sure that the wiper arm does not spring back against the glass when the wiper blade is not attached.*

2. Slightly rotate the wiper blade.
3. Remove the wiper blade.
4. Install in the reverse order.

**Note:** *Make sure that the wiper blade locks into place.*

# Maintenance

## Rear Window Wiper Blade

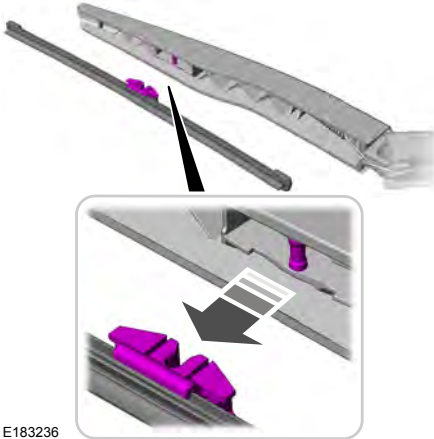

E183236

1. Lift the wiper arm.

**Note:** Do not hold the wiper blade when lifting the wiper arm.

**Note:** Make sure that the wiper arm does not spring back against the glass when the wiper blade is not attached.

2. Remove the wiper blade.

**Note:** Make sure that the wiper blade locks into place.

## ADJUSTING THE HEADLAMPS

### Vertical Aim Adjustment

If your vehicle has been involved in a crash, have the aim of the headlamp beam checked by an authorized dealer.

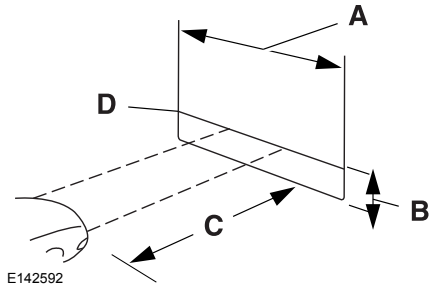

E142592

- A 8 ft (2.4 m)
- B Ground to the center of the headlamp high beam bulb
- C 25 ft (7.6 m)
- D Horizontal reference line

### Vertical Aim Adjustment Procedure

1. Park your vehicle on level ground approximately 25 ft (7.6 m) from a wall or screen.
2. Measure the distance from the ground to the center of the headlamp high beam bulb and mark an 8 ft (2.4 m) long horizontal reference line on the wall or screen at this height.

**Note:** There may be an identifying mark on the lens to help you locate the center line of the headlamp high beam bulb. Refer to the graphic below step 4.

**Note:** To see a clearer light pattern for adjusting, you may want to block the light from one headlamp while adjusting the other.

3. Switch on the low beam headlamps and open the hood.

# Maintenance



E142465

4. On the wall or screen you will observe a flat zone of high intensity light located at the top of the beam pattern. If the top edge of the flat zone of high intensity light is not on the horizontal reference line, adjust the aim of the headlamp beam.

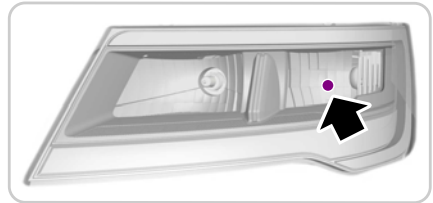
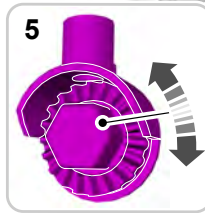
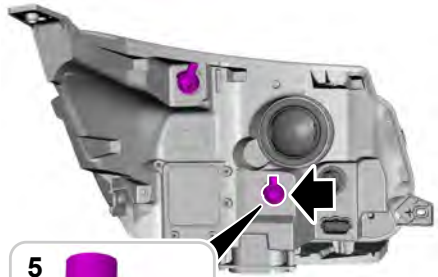

E203691

5. Use a suitable tool, for example a screwdriver or socket wrench, to turn the adjuster clockwise or counterclockwise to adjust the vertical aim of the headlamp. The horizontal edge of the brighter light should touch the horizontal reference line.
6. Close the hood and switch off the lamps.



# Maintenance

## REMOVING A HEADLAMP

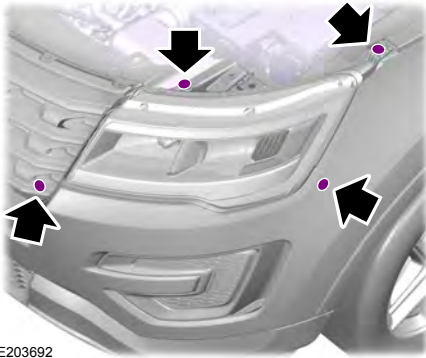

To gain access to the headlamp securing bolts and to remove the headlamp assembly, you must first remove the front fascia and front bumper assemblies. We recommend you see an authorized dealer.

## CHANGING A BULB

### WARNINGS



Switch the lamps and the ignition off. Failure to do so could result in serious personal injury.



Bulbs become hot when in use. Let them cool down before you remove them.

Use the correct specification bulb. See **Bulb Specification Chart** (page 294). Install in the reverse order unless otherwise stated.

## Headlamp

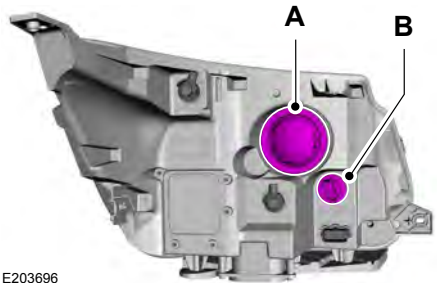

- A Headlamp high beam.
- B Front direction indicator.

## Front Direction Indicator

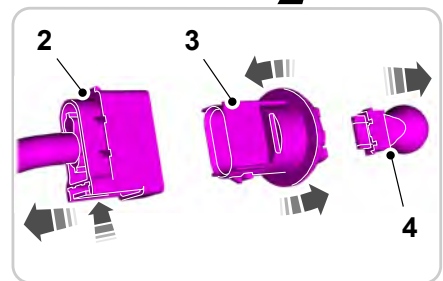
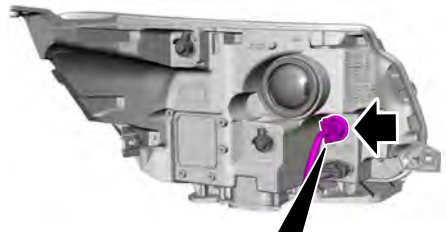

E203698

1. Switch all of the lamps and the ignition off.
2. Disconnect the electrical connector.

# Maintenance

3. Turn the bulb holder counterclockwise and remove it.
4. Remove the bulb by pulling it straight out.

## Headlamp High Beam

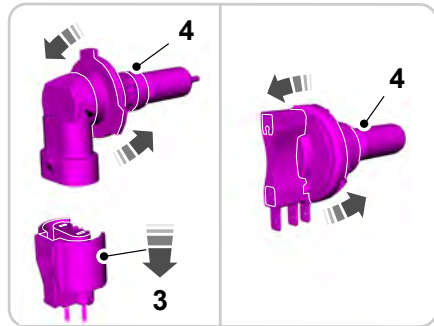
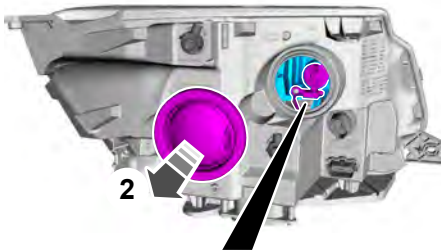

E203697

1. Switch all of the lamps and the ignition off.
2. Carefully remove the cover.
3. Disconnect the electrical connector.
4. Turn the bulb holder counterclockwise and remove it.

**Note:** You cannot separate the bulb from the bulb holder.

**Note:** Do not touch the bulb glass.

## Front Fog Lamp (If Equipped)

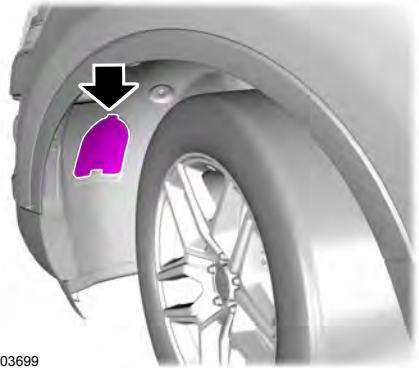

E203699

1. Use a suitable tool, for example a screwdriver, to carefully remove the housing cover.

**Note:** To remove push pins, use a flat-bladed screwdriver to pull up the center release pin.

2. Disconnect the electrical connector.



E174588

3. Turn the bulb holder counterclockwise and remove it.

**Note:** You cannot separate the bulb from the bulb holder.

**Note:** Do not touch the bulb glass.

# Maintenance

## Rear Direction Indicator and Reversing Lamp

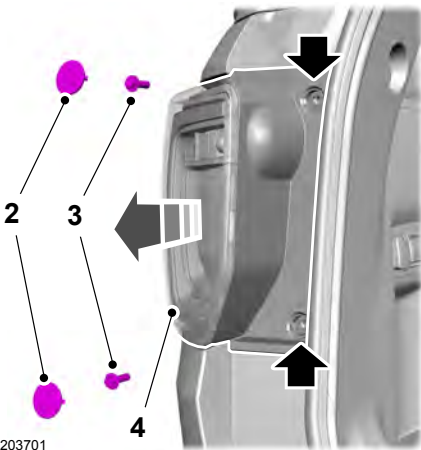

E203701

1. Switch all of the lamps and the ignition off.
2. Use a suitable tool, for example a screwdriver, to carefully remove the screw covers.
3. Remove the retaining bolts from the lamp assembly.
4. Gently pull the lamp assembly away from the vehicle.

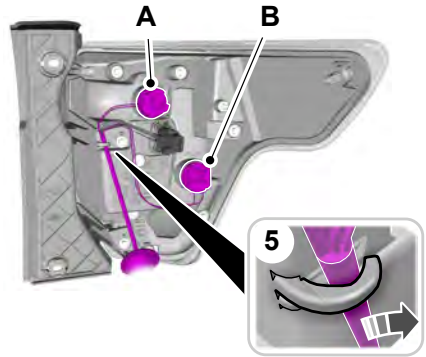

E203702

5. Release the wire from the securing clip.
6. Turn the bulb holder counterclockwise and remove it.
7. Remove the bulb by pulling it straight out.

## LED Lamps

LED lamps are not serviceable items. See an authorized dealer if they fail.

The following lamps are LED:

- Front side marker lamps.
- Front signature lamps.
- Daytime running lamps.
- Headlamp low beam.
- Side direction indicator.
- Rear side marker lamp.

# Maintenance

- Brake and rear lamp.
- Central high mounted brake lamp.

## License Plate Lamp

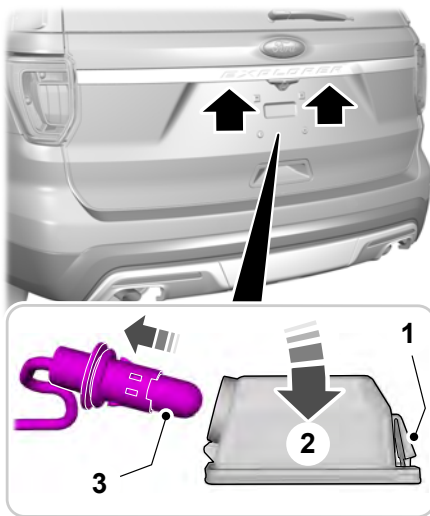

E203703

## Exterior Lamps

| Lamp                       | Specification | Power (Watt) |
|----------------------------|---------------|--------------|
| Front side marker lamps.   | LED           | LED          |
| Front signature lamps.     | LED           | LED          |
| Front direction indicator. | 3757NAK       | 27           |
| Daytime running lamps.     | LED           | LED          |
| Headlamp low beam.         | LED           | LED          |
| Headlamp high beam.        | 9005LL        | 55           |
| Front fog lamps.           | 9145          | 45           |
| Side direction indicator.  | LED           | LED          |
| Rear side marker lamp.     | LED           | LED          |

1. Use a suitable tool, for example a screwdriver, to carefully remove the lamp.
2. Turn the bulb holder counterclockwise and remove it.
3. Remove the bulb by pulling it straight out.

## BULB SPECIFICATION CHART

Replacement bulbs are specified in the chart below. Headlamp bulbs must be marked with an authorized D.O.T. marking for North America to make sure they have the proper lamp performance, light brightness, light pattern and safe visibility. The correct bulbs will not damage the lamp assembly or void the lamp assembly warranty and will provide quality bulb illumination time.

# Maintenance

| Lamp                             | Specification | Power (Watt) |
|----------------------------------|---------------|--------------|
| Brake and rear lamp.             | LED           | LED          |
| Central high mounted brake lamp. | LED           | LED          |
| Rear direction indicator.        | WY21W         | 21           |
| Reversing lamps.                 | W21W          | 21           |
| License plate lamp.              | W5W           | 5            |

**Note:** LED lamps are not serviceable. See an authorized dealer if they fail.

## Interior Lamps

| Lamp                      | Specification | Power (Watt) |
|---------------------------|---------------|--------------|
| Glove compartment lamp.   | 194           | 4            |
| Interior lamp.            | W5W           | 5            |
| Vanity mirror lamp.       | A6224PF       |              |
| Overhead console lamp.    | W5W           | 5            |
| Rear dome lamp.           | LED           | LED          |
| Luggage compartment lamp. | LED           | LED          |

**Note:** LED lamps are not serviceable. See an authorized dealer if they fail.

# Maintenance

## CHANGING THE ENGINE AIR FILTER

### WARNING



To reduce the risk of vehicle damage and personal burn injuries, do not start your engine with the air cleaner removed and do not remove it while the engine is running.

When changing the engine air filter, do not allow debris or foreign material to enter the air induction system. Engine components are susceptible to damage not covered by the vehicle Warranty.

Change the air filter element at the correct interval. See **Scheduled Maintenance** (page 483).

Incorrect component use can cause damage not covered by the vehicle Warranty. See **Motorcraft Parts** (page 333).

To replace the air filter element do the following:

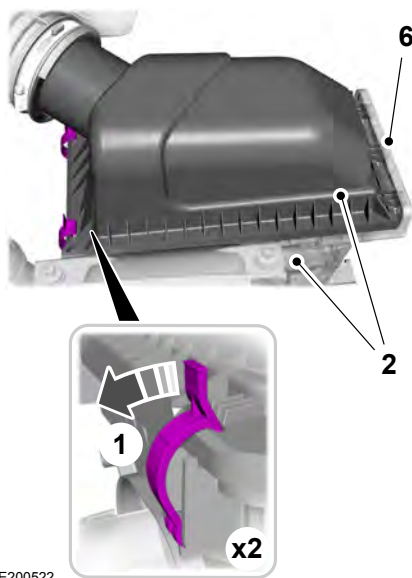

E200522

1. Remove the clips that secure the air filter housing cover.
2. Carefully lift the air filter housing cover.
3. Remove the air filter element from the air filter housing.
4. Wipe any dirt or debris from the air filter housing and cover to make sure no dirt gets in the engine and that you have a good seal.
5. Install a new air filter element. Be careful not to crimp the filter element edges between the air filter housing and cover. This could cause filter damage and allow unfiltered air to enter the engine if it is not properly seated.
6. Install the air filter housing cover.
7. Engage the clips to secure the air filter housing cover to the air filter housing.

# Vehicle Care

## GENERAL INFORMATION

Your Ford or Lincoln authorized dealer has many quality products available to clean your vehicle and protect its finishes.

### Materials

| Name  | Specification |
|---|---------------|
| Motorcraft Bug and Tar Remover<br>ZC-42   | -             |
| Motorcraft Custom Bright Metal Cleaner<br>ZC-15   | -             |
| Motorcraft® Detail Wash<br>ZC-3-A   | ESR-M14P4-A   |
| Motorcraft Engine Shampoo and Degreaser (U.S.)<br>ZC-20 (U.S.)                              | -             |
| Engine Shampoo  | -             |
| Motorcraft Leather and Vinyl Cleaner<br>ZC-56   | -             |
| Multi-Purpose Cleaner   | -             |
| Motorcraft® Premium Windshield Wash Concentrate with<br>Bitterant (U.S.)<br>ZC-32-B2 (U.S.) | WSS-M14P19-A  |
| Professional Strength Carpet and Upholstery Cleaner<br>ZC-54                                | -             |
| Motorcraft Spot and Stain Remover (U.S.)<br>ZC-14 (U.S.)                                    | -             |
| Motorcraft® Ultra-Clear Spray Glass Cleaner (U.S.)<br>ZC-23 (U.S.)                          | ESR-M14P5-A   |
| Motorcraft® Wheel and Tire Cleaner<br>ZC-37-A   | -             |

## CLEANING PRODUCTS

For best results, use the following products or products of equivalent quality:

## CLEANING THE EXTERIOR

Wash your vehicle regularly with cool or lukewarm water and a neutral pH shampoo, we recommend Motorcraft Detail Wash.

- Never use strong household detergents or soap, for example dish washing or laundry liquid. These products can discolor and spot painted surfaces.
- Never wash your vehicle when it is hot to the touch, or during strong or direct sunlight.
- Dry your vehicle with a chamois or soft terry cloth towel to eliminate water spotting.

# Vehicle Care

---

- Immediately remove fuel spillages, bird droppings, insect deposits and road tar. These may cause damage to your vehicle's paintwork or trim over time. We recommend Motorcraft Bug and Tar Remover.
- Remove any exterior accessories, for example antennas, before entering a car wash.

**Note:** *Suntan lotions and insect repellents can damage painted surfaces. If these substances come in contact with your vehicle, wash the affected area as soon as possible.*

## Exterior Chrome Parts

- Apply a high quality-cleaning product to bumpers and other chrome parts. Follow the manufacturer's instructions. We recommend Motorcraft Custom Bright Metal Cleaner.
- Do not apply the cleaning product to hot surfaces. Do not leave the cleaning product on chrome surfaces longer than the time recommended.
- Using other non-recommended cleaners can result in severe and permanent cosmetic damage.

**Note:** *Never use abrasive materials, for example steel wool or plastic pads as they can scratch the chrome surface.*

**Note:** *Do not use chrome cleaner, metal cleaner or polish on wheels or wheel covers.*

## Exterior Plastic Parts

For routine cleaning we recommend Motorcraft Detail Wash. If tar or grease spots are present, we recommend Motorcraft Bug and Tar Remover.

## Stripes or Graphics (If Equipped)

Hand washing your vehicle is preferred however, pressure washing may be used under the following conditions:

- Do not use water pressure higher than 2,000 psi (14,000 kPa).
- Do not use water hotter than 179°F (82°C).
- Use a spray with a 40° wide spray angle pattern.
- Keep the nozzle at a 12 in (305 mm) distance and 90° angle to your vehicle's surface.

**Note:** *Holding the pressure washer nozzle at an angle to the vehicle's surface may damage graphics and cause the edges to peel away from the vehicle's surface.*

## Underbody

Flush the complete underside of your vehicle frequently. Keep body and door drain holes free of debris or foreign material.

## Under Hood

For removing black rubber marks from under the hood we recommend Motorcraft Wheel and Tire Cleaner or Motorcraft Bug and Tar Remover.

## WAXING

Regular waxing is necessary to protect your car's paint from the elements. We recommend that you wash and wax the painted surface once or twice a year.

When washing and waxing, park your vehicle in a shaded area out of direct sunlight. Always wash your vehicle before applying wax.

- Use a quality wax that does not contain abrasives.
- Follow the manufacturer's instructions to apply and remove the wax.
- Apply a small amount of wax in a back-and-forth motion, not in circles.



# Vehicle Care

---

- Do not allow wax to come in contact with any non-body (low-gloss black) colored trim. The wax will discolor or stain the parts over time.
  - Roof racks.
  - Bumpers.
  - Grained door handles.
  - Side moldings.
  - Mirror housings.
  - Windshield cowl area.
- Do not apply wax to glass areas.
- After waxing, your car's paint should feel smooth, and be free of streaks and smudges.
- Never wash or rinse any ignition coil, spark plug wire or spark plug well, or the area in and around these locations.
- Cover the battery, power distribution box, and air filter assembly to prevent water damage when cleaning the engine.

## CLEANING THE WINDOWS AND WIPER BLADES

Car wash chemicals and environmental fallout can result in windshield and wiper blade contamination. Dirty windshield and wipers will result in poor windshield wiper operation. Keep the windshield and wiper blades clean to maintain windshield wiper performance.

To clean the windshield and wiper blades:

- Clean the windshield with a non-abrasive glass cleaner. When cleaning the interior of the windshield, avoid getting any glass cleaner on the instrument panel or door panels. Wipe any glass cleaner off these surfaces immediately.
- For windshields contaminated with tree sap, chemicals, wax or bugs, clean the entire windshield using steel wool (no greater than 0000 grade) in a circular motion and rinse with water.
- Clean the wiper blades with isopropyl rubbing alcohol or windshield washer concentrate.

**Note:** *Do not use razor blades or other sharp objects to clean or remove decals from the inside of the heated rear window. The vehicle warranty does not cover damage caused to the heated rear window grid lines.*

## CLEANING THE ENGINE

Engines are more efficient when they are clean because grease and dirt buildup keep the engine warmer than normal.

When washing:

- Take care when using a power washer to clean the engine. The high-pressure fluid could penetrate the sealed parts and cause damage.
- Do not spray a hot engine with cold water to avoid cracking the engine block or other engine components.
- Spray Motorcraft Engine Shampoo and Degreaser on all parts that require cleaning and pressure rinse clean. In Canada, use Motorcraft Engine Shampoo.
- Never wash or rinse the engine while it is hot or running; water in the running engine may cause internal damage.

# Vehicle Care

## CLEANING THE INTERIOR

### WARNINGS



Do not use cleaning solvents, bleach or dye on the vehicle's safety belts, as these actions may weaken the belt webbing.



On vehicles equipped with seat-mounted airbags, do not use chemical solvents or strong detergents. Such products could contaminate the side airbag system and affect performance of the side airbag in a collision.

For fabric, carpets, cloth seats, safety belts and seats equipped with side airbags:

- Remove dust and loose dirt with a vacuum cleaner.
- Remove light stains and soil with Motorcraft Professional Strength Carpet & Upholstery Cleaner.
- If grease or tar is present on the material, spot-clean the area first with Motorcraft Spot and Stain Remover. In Canada, use Motorcraft Multi-Purpose Cleaner.
- If a ring forms on the fabric after spot cleaning, clean the entire area immediately (but do not oversaturate) or the ring will set.
- Do not use household cleaning products or glass cleaners, which can stain and discolor the fabric and affect the flame retardant abilities of the seat materials.

## CLEANING THE INSTRUMENT PANEL AND INSTRUMENT CLUSTER LENS

### WARNING



Do not use chemical solvents or strong detergents when cleaning the steering wheel or instrument panel to avoid contamination of the airbag system.

**Note:** Follow the same procedure as cleaning leather seats for cleaning leather instrument panels and leather interior trim surfaces. See **Cleaning Leather Seats** (page 301).

Clean the instrument panel and cluster lens with a clean, damp and soft cloth, then use a clean, dry and soft cloth to dry these areas.

- Avoid cleaners or polishes that increase the gloss of the upper portion of the instrument panel. The dull finish in this area helps protect you from undesirable windshield reflection.
- Do not use any household cleaning products or glass cleaners as these may damage the finish of the instrument panel, interior trim and cluster lens.
- Wash or wipe your hands clean if you have been in contact with certain products such as insect repellent and suntan lotion to avoid possible damage to the interior painted surfaces.
- Do not allow air fresheners and hand sanitizers to spill onto interior surfaces. If a spill occurs, wipe off immediately. Your warranty may not cover these damages.

If a staining liquid like coffee or juice has been spilled on the instrument panel or on interior trim surfaces:

# Vehicle Care

---

1. Wipe up spilled liquid using a clean, soft cloth as quickly as possible.
2. Use Motorcraft Premium Leather and Vinyl Cleaner or a commercially available leather cleaning product for automotive interiors. Test any cleaner or stain remover on an inconspicuous area.
3. Alternatively, wipe the surface with a clean, soft cloth and a mild soap and water solution. Dry the area with a clean, soft cloth.
4. If necessary, apply more soap and water solution or cleaning product to a clean, soft cloth and press it onto the soiled area. Allow this to set at room temperature for 30 minutes.
5. Remove the soaked cloth, then with a clean, damp cloth, use a rubbing motion for 60 seconds on the soiled area.
6. Dry the area with a clean, soft cloth.

## **CLEANING LEATHER SEATS (If Equipped)**

**Note:** Follow the same procedure as cleaning leather seats for cleaning leather instrument panels and leather interior trim surfaces.

For routine cleaning, wipe the surface with a soft, damp cloth and a mild soap and water solution. Dry the area with a clean, soft cloth.

For cleaning and removing stains such as dye transfer, use Motorcraft Premium Leather and Vinyl Cleaner or a commercially available leather cleaning product for automotive interiors.

**Note:** Test any cleaner or stain remover on an inconspicuous area.

You should:

- Remove dust and loose dirt with a vacuum cleaner.
- Clean and treat spills and stains as soon as possible.

Do not use the following products as these may damage the leather:

- Oil and petroleum or silicone-based leather conditioners.
- Household cleaners.
- Alcohol solutions.
- Solvents or cleaners intended specifically for rubber, vinyl and plastics.

## **REPAIRING MINOR PAINT DAMAGE**

Authorized dealers have touch-up paint to match your vehicle's color. Your vehicle color code is printed on a sticker on the front, left-hand side door jamb. Take your color code to your authorized dealer to make sure you get the correct color.

Before repairing minor paint damage, use a cleaner such as Motorcraft Bug and Tar Remover to remove particles such as bird droppings, tree sap, insect deposits, tar spots, road salt and industrial fallout.

Always read the instructions before using cleaning products.

## **CLEANING THE ALLOY WHEELS (If Equipped)**

**Note:** Do not apply a cleaning chemical to warm or hot wheel rims and covers.

**Note:** Some automatic car washes may cause damage to the finish on your wheel rims and covers.

# Vehicle Care

---

**Note:** *Industrial-strength or heavy-duty cleaners in combination with brush agitation to remove brake dust and dirt, could wear away the clear coat finish over a period time.*

**Note:** *Do not use hydrofluoric acid-based or high caustic-based wheel cleaners, steel wool, fuels or strong household detergents.*

**Note:** *If you intend parking your vehicle for an extended period after cleaning the wheels with a wheel cleaner, drive your vehicle for a few minutes before doing so. This will reduce the risk of increased corrosion of the brake discs.*

Alloy wheels and wheel covers are coated with a clear coat paint finish. To maintain their condition we recommend that you:

- Clean the wheels weekly using Motorcraft Wheel and Tire Cleaner. Apply using manufacturer's instructions.
- Use a sponge to remove heavy deposits of dirt and brake dust accumulation.
- Rinse thoroughly with a strong stream of water when you have completed the cleaning process.
- To remove tar and grease, use Motorcraft Bug and Tar Remover.

## VEHICLE STORAGE

If you plan on storing your vehicle for 30 days or more, read the following maintenance recommendations to make sure your vehicle stays in good operating condition.

We engineer and test all motor vehicles and their components for reliable, regular driving. Under various conditions, long-term storage may lead to degraded engine performance or failure unless you use specific precautions to preserve engine components.

## General

- Store all vehicles in a dry, ventilated place.
- Protect from sunlight, if possible.
- If vehicles are stored outside, they require regular maintenance to protect against rust and damage.

## Body

- Wash your vehicle thoroughly to remove dirt, grease, oil, tar or mud from exterior surfaces, rear-wheel housing and the underside of front fenders.
- Periodically wash your vehicle if it is stored in exposed locations.
- Touch-up exposed or primed metal to prevent rust.
- Cover chrome and stainless steel parts with a thick coat of auto wax to prevent discoloration. Re-wax as necessary when you wash your vehicle.
- Lubricate all hood, door and luggage compartment hinges and latches with a light grade oil.
- Cover interior trim to prevent fading.
- Keep all rubber parts free from oil and solvents.

## Engine

- Change the engine oil and filter prior to storage because used engine oil contains contaminants which may cause engine damage.
- Start the engine every 15 days for a minimum of 15 minutes. Run at fast idle with the climate controls set to defrost until the engine reaches normal operating temperature.

# Vehicle Care

---

- With your foot on the brake, shift through all the gears while the engine is running.
- We recommend that you change the engine oil before you use your vehicle again.

## Fuel system

- Fill the fuel tank with high-quality fuel until the first automatic shutoff of the fuel pump nozzle.

## Cooling system

- Protect against freezing temperatures.
- When removing your vehicle from storage, check coolant fluid level. Confirm that there are no cooling system leaks and that fluid is at the recommended level.

## Battery

- Check and recharge as necessary. Keep connections clean.
- If storing your vehicle for more than 30 days without recharging the battery, we recommend that you disconnect the battery cables to maintain battery charge for quick starting.

**Note:** *It is necessary to reset memory features if battery cables are disconnected.*

## Brakes

- Make sure the brakes and parking brake release fully.

## Tires

- Maintain recommended air pressure.

## Miscellaneous

- Make sure all linkages, cables, levers and pins under your vehicle are covered with grease to prevent rust.
- Move vehicles at least 25 ft (7.5 m) every 15 days to lubricate working parts and prevent corrosion.

## Removing Vehicle From Storage

When your vehicle is ready to come out of storage, do the following:

- Wash your vehicle to remove any dirt or grease film build-up on window surfaces.
- Check windshield wipers for any deterioration.
- Check under the hood for any foreign material that may have collected during storage such as mice or squirrel nests.
- Check the exhaust for any foreign material that may have collected during storage.
- Check tire pressures and set tire inflation per the Tire Label.
- Check brake pedal operation. Drive your vehicle 15 ft (4.5 m) back and forth to remove rust build-up.
- Check fluid levels (including coolant, oil and gas) to make sure there are no leaks, and fluids are at recommended levels.
- If you remove the battery, clean the battery cable ends and check for damage.

Contact an authorized dealer if you have any concerns or issues.

# Wheels and Tires

## GENERAL INFORMATION

Use only approved wheel and tire sizes, using other sizes could damage your vehicle. If you change the diameter of the tires from that fitted at the factory, the speedometer may not display the correct speed. Take your vehicle to an authorized Ford dealer to have the system reprogrammed. If you intend to change the size of the wheels from that fitted by the manufacturer, you can check the suitability with an authorized dealer.

Additional information related to the functionality and maintenance of your tires can be found later in this chapter. See **Tire Care** (page 307).

The Ford recommended tire inflation pressures can be found on the Tire Label, which is located on the B-pillar or the edge of the driver's door. This information can also be found on the Safety Compliance Certification Label (affixed to either the door hinge pillar, door-latch post, or the door edge that meets the door last post; next to the driver's seating position).

Ford strongly recommends maintaining these tire pressures at all times. Failure to follow the tire pressure recommendations can cause uneven treadwear patterns, reduced fuel economy, and adversely affect the way your vehicle handles.

**Note:** Check and set the tire pressure at the ambient temperature in which you are intending to drive your vehicle and when the tires are cold.

**Note:** Check your tire pressures at least once per month.

Set the pressure for your spare tire to the highest value given for your vehicle and tire size combination (if equipped).

## Notice to utility vehicle and truck owners

### WARNINGS

 Utility vehicles have a significantly higher rollover rate than other types of vehicles. To reduce the risk of serious injury or death from a rollover or other crash you must avoid sharp turns and abrupt maneuvers, drive at safe speeds for the conditions, keep tires inflated to Ford recommended pressures, never overload or improperly load your vehicle, and make sure every passenger is properly restrained.

 In a rollover crash, an unbelted person is significantly more likely to die than a person wearing a seat belt. All occupants must wear seat belts and children/infants must use appropriate restraints to minimize the risk of injury or ejection.

 Do not become overconfident in the ability of four-wheel drive vehicles. Although a four-wheel drive vehicle may accelerate better than a two-wheel drive vehicle in low traction situations, it won't stop any faster than two-wheel drive vehicles. Always drive at a safe speed.



E145298

# Wheels and Tires

---

Utility vehicles and trucks handle differently than passenger cars in the various driving conditions that are encountered on streets, highways and off-road. Utility vehicles and trucks are not designed for cornering at speeds as high as passenger cars any more than low-slung sports cars are designed to perform satisfactorily under off-road conditions.

Study your owner's manual and any supplements for specific information about equipment features, instructions for safe driving and additional precautions to reduce the risk of an accident or serious injury.

## Four-wheel drive system (If Equipped)

### WARNING



Do not become overconfident in the ability of four-wheel drive vehicles. Although a four-wheel drive vehicle may accelerate better than a two-wheel drive vehicle in low traction situations, it won't stop any faster than two-wheel drive vehicles. Always drive at a safe speed.

A vehicle equipped with four-wheel drive (when selected) has the ability to use all four wheels to power itself. This increases traction which may enable you to safely drive over terrain and road conditions that a conventional two-wheel drive vehicle cannot.

Power is supplied to all four wheels through a transfer case or power transfer unit. Four-wheel drive vehicles allow you to select different modes as necessary. For information on transfer case operation and shifting procedures, See **Four-Wheel Drive** (page 180). For information on transfer case maintenance, See **Maintenance** (page 273). You should become thoroughly familiar with this information before you operate your vehicle.

On some four-wheel drive vehicles, the initial shift from two-wheel to four-wheel drive while the vehicle is moving can cause a momentary clunk and ratcheting sound. These sounds are normal and are not cause for concern.

For four-wheel drive vehicles, a spare tire of a different size other than the tire provided should never be used. A dissimilar spare tire size (other than the spare tire provided) or major dissimilar tire sized between the front and rear axles could cause the four-wheel drive system to stop functioning and default to front-wheel drive. See **Principle of Operation** (page 180).

## How your vehicle differs from other vehicles

Sport utility vehicles and trucks can differ from some other vehicles in a few noticeable ways. Your vehicle may be:

# Wheels and Tires

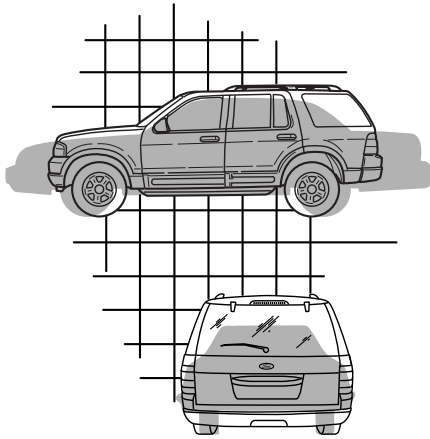

E145299

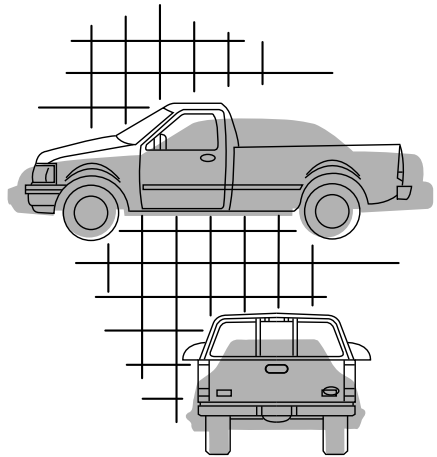

E168583

- Higher - to allow higher load carrying capacity and to allow it to travel over rough terrain without getting hung up or damaging underbody components.
- Shorter - to give it the capability to approach inclines and drive over the crest of a hill without getting hung up or damaging underbody components. All other things held equal, a shorter wheelbase may make your vehicle quicker to respond to steering inputs than a vehicle with a longer wheelbase.
- Narrower - to provide greater maneuverability in tight spaces, particularly in off-road use.

As a result of the above dimensional differences, Sport utility vehicles and trucks often will have a higher center of gravity and a greater difference in center of gravity between the loaded and unloaded condition. These differences that make your vehicle so versatile also make it handle differently than an ordinary passenger car.



# Wheels and Tires

## TIRE CARE

### Information About Uniform Tire Quality Grading



E142542

Tire Quality Grades apply to new pneumatic passenger car tires. The Quality grades can be found where applicable on the tire sidewall between tread shoulder and maximum section width. For example: **Treadwear 200 Traction AA Temperature A.**

These Tire Quality Grades are determined by standards that the United States Department of Transportation has set.

Tire Quality Grades apply to new pneumatic passenger car tires. They do not apply to deep tread, winter-type snow tires, space-saver or temporary use spare tires, light truck or LT type tires, tires with nominal rim diameters of 10 to 12 inches or limited production tires as defined in Title 49 Code of Federal Regulations Part 575.104 (c)(2).

### U.S. Department of Transportation Tire quality grades:

The U.S. Department of Transportation requires Ford Motor Company to give you the following information about tire grades exactly as the government has written it.

#### Treadwear

The treadwear grade is a comparative rating based on the wear rate of the tire when tested under controlled conditions on a specified government test course. For example, a tire graded 150 would wear 1½ times as well on the government course as a tire graded 100. The relative performance of tires depends upon the actual conditions of their use, however, and may depart significantly from the norm due to variations in driving habits, service practices, and differences in road characteristics and climate.

#### Traction AA A B C

#### WARNING



The traction grade assigned to this tire is based on straight-ahead braking traction tests, and does not include acceleration, cornering, hydroplaning or peak traction characteristics.

# Wheels and Tires

---

The traction grades, from highest to lowest are AA, A, B, and C. The grades represent the tire's ability to stop on wet pavement as measured under controlled conditions on specified government test surfaces of asphalt and concrete. A tire marked C may have poor traction performance.

## Temperature A B C

### WARNING



The temperature grade for this tire is established for a tire that is properly inflated and not overloaded. Excessive speed, underinflation, or excessive loading, either separately or in combination, can cause heat buildup and possible tire failure.

The temperature grades are A (the highest), B and C, representing the tire's resistance to the generation of heat and its ability to dissipate heat when tested under controlled conditions on a specified indoor laboratory test wheel. Sustained high temperature can cause the material of the tire to degenerate and reduce tire life, and excessive temperature can lead to sudden tire failure. The grade C corresponds to a level of performance which all passenger car tires must meet under the

Federal Motor Vehicle Safety Standard No. 139. Grades B and A represent higher levels of performance on the laboratory test wheel than the minimum required by law.

## Glossary of Tire Terminology

\***Tire label:** A label showing the original equipment tire sizes, recommended inflation pressure and the maximum weight the vehicle can carry.

\***Tire Identification Number (TIN):** A number on the sidewall of each tire providing information about the tire brand and manufacturing plant, tire size and date of manufacture. Also referred to as DOT code.

\***Inflation pressure:** A measure of the amount of air in a tire.

\***Standard load:** A class of P-metric or Metric tires designed to carry a maximum load at set pressure. For example: For P-metric tires 35 psi (2.4 bar) and for Metric tires 36 psi (2.5 bar). Increasing the inflation pressure beyond this pressure will not increase the tire's load carrying capability.

\***Extra load:** A class of P-metric or Metric tires designed to carry a heavier maximum load at 42 psi (2.9 bar). Increasing the inflation pressure beyond this pressure will not increase the tire's load carrying capability.

# Wheels and Tires

\***kPa:** Kilopascal, a metric unit of air pressure.

\***PSI:** Pounds per square inch, a standard unit of air pressure.

\***Cold tire pressure:** The tire pressure when the vehicle has been stationary and out of direct sunlight for an hour or more and prior to the vehicle being driven for 1 mi (1.6 km).

\***Recommended inflation pressure:** The cold inflation pressure found on the Safety Compliance Certification Label (affixed to either the door hinge pillar, door-latch post, or the door edge that meets the door-latch post, next to the driver's seating position), or Tire Label located on the B-Pillar or the edge of the driver door.

\***B-pillar:** The structural member at the side of the vehicle behind the front door.

\***Bead area of the tire:** Area of the tire next to the rim.

\***Sidewall of the tire:** Area between the bead area and the tread.

\***Tread area of the tire:** Area of the perimeter of the tire that contacts the road when mounted on the vehicle.

\***Rim:** The metal support (wheel) for a tire or a tire and tube assembly upon which the tire beads are seated.

## Information Contained on the Tire Sidewall

Both United States and Canada Federal regulations require tire manufacturers to place standardized information on the sidewall of all tires. This information identifies and describes the fundamental characteristics of the tire and also provides a U.S. DOT Tire Identification Number for safety standard certification and in case of a recall.

## Information on P Type Tires

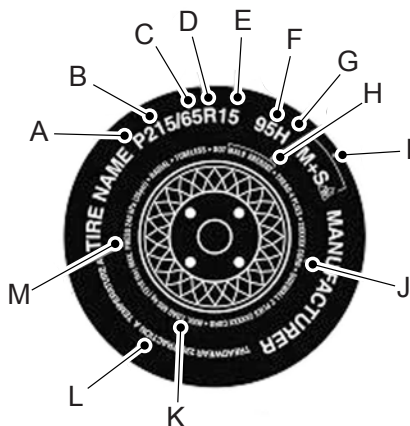

E142543

P215/65R15 95H is an example of a tire size, load index and speed rating. The definitions of these items are listed below. (Note that the tire size, load index and speed rating for your vehicle may be different from this example.)

# Wheels and Tires

A. **P:** Indicates a tire, designated by the Tire and Rim Association, that may be used for service on cars, sport utility vehicles, minivans and light trucks. **Note:** If your tire size does not begin with a letter this may mean it is designated by either the European Tire and Rim Technical Organization or the Japan Tire Manufacturing Association.

B. **215:** Indicates the nominal width of the tire in millimeters from sidewall edge to sidewall edge. In general, the larger the number, the wider the tire.

C. **65:** Indicates the aspect ratio which gives the tire's ratio of height to width.

D. **R:** Indicates a radial type tire.

E. **15:** Indicates the wheel or rim diameter in inches. If you change your wheel size, you will have to purchase new tires to match the new wheel diameter.

F. **95:** Indicates the tire's load index. It is an index that relates to how much weight a tire can carry. You may find this information in your owner's manual. If not, contact a local tire dealer.

**Note:** *You may not find this information on all tires because it is not required by federal law.*

G. **H:** Indicates the tire's speed rating. The speed rating denotes the speed at which a tire is designed to be driven for extended periods of time under a standard condition of load and inflation pressure. The tires on your vehicle may operate at different conditions for load and inflation pressure. These speed ratings may need to be adjusted for the difference in conditions. The ratings range from 81 mph (130 km/h) to 186 mph (299 km/h). These ratings are listed in the following chart.

**Note:** *You may not find this information on all tires because it is not required by federal law.*

| Letter rating | Speed rating       |
|---------------|--------------------|
| M             | 81 mph (130 km/h)  |
| N             | 87 mph (140 km/h)  |
| Q             | 99 mph (159 km/h)  |
| R             | 106 mph (171 km/h) |
| S             | 112 mph (180 km/h) |
| T             | 118 mph (190 km/h) |
| U             | 124 mph (200 km/h) |
| H             | 130 mph (210 km/h) |
| V             | 149 mph (240 km/h) |

# Wheels and Tires

| Letter rating | Speed rating       |
|---------------|--------------------|
| W             | 168 mph (270 km/h) |
| Y             | 186 mph (299 km/h) |

**Note:** For tires with a maximum speed capability over 149 mph (240 km/h), tire manufacturers sometimes use the letters ZR. For those with a maximum speed capability over 186 mph (299 km/h), tire manufacturers always use the letters ZR.

**H. U.S. DOT Tire Identification Number (TIN):** This begins with the letters DOT and indicates that the tire meets all federal standards. The next two numbers or letters are the plant code designating where it was manufactured, the next two are the tire size code and the last four numbers represent the week and year the tire was built. For example, the numbers 317 mean the 31st week of 1997. After 2000, the numbers go to four digits. For example, 2501 means the 25th week of 2001. The numbers in between are identification codes used for traceability. This information is used to contact customers if a tire defect requires a recall.

**I. M+S or M/S:** Mud and Snow, or  
**AT:** All Terrain, or  
**AS:** All Season.

**J. Tire Ply Composition and Material Used:** Indicates the number of plies or the number of layers of rubber-coated fabric in the tire tread and sidewall. Tire manufacturers also must indicate the ply materials in the tire and the sidewall, which include steel, nylon, polyester, and others.

**K. Maximum Load:** Indicates the maximum load in kilograms and pounds that can be carried by the tire. See the Safety Compliance Certification Label (affixed to either the door hinge pillar, door-latch post, or the door edge that meets the door-latch post, next to the driver's seating position), for the correct tire pressure for your vehicle.

**L. Treadwear, Traction and Temperature Grades:**

**\*Treadwear** The treadwear grade is a comparative rating based on the wear rate of the tire when tested under controlled conditions on a specified government test course. For example, a tire graded 150 would wear one and one-half times as well on the government course as a tire graded 100.

# Wheels and Tires

**\*Traction:** The traction grades, from highest to lowest are AA, A, B, and C. The grades represent the tire's ability to stop on wet pavement as measured under controlled conditions on specified government test surfaces of asphalt and concrete. A tire marked C may have poor traction performance.

**\*Temperature:** The temperature grades are A (the highest), B and C, representing the tire's resistance to the generation of heat and its ability to dissipate heat when tested under controlled conditions on a specified indoor laboratory test wheel.

## M. Maximum Inflation Pressure:

Indicates the tire manufacturers' maximum permissible pressure or the pressure at which the maximum load can be carried by the tire. This pressure is normally higher than the vehicle manufacturer's recommended cold inflation pressure which can be found on the Safety Compliance Certification Label (affixed to either the door hinge pillar, door-latch post, or the door edge that meets the door-latch post, next to the driver's seating position), or Tire Label which is located on the B-Pillar or the edge of the driver's door. The cold inflation pressure should never be set lower than the recommended pressure on the vehicle label.

The tire suppliers may have additional markings, notes or warnings such as standard load or radial tubeless.

## Additional Information Contained on the Tire Sidewall for LT Type Tires

**Note:** *Tire Quality Grades do not apply to this type of tire.*

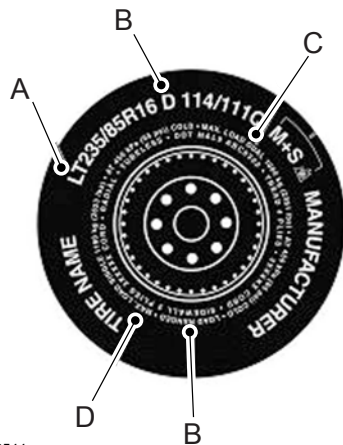

E142544

LT type tires have some additional information beyond those of P type tires; these differences are described below.

**A. LT:** Indicates a tire, designated by the Tire and Rim Association, that is intended for service on light trucks.

**B. Load Range and Load Inflation Limits:** Indicates the tire's load-carrying capabilities and its inflation limits.

## Wheels and Tires

**C. Maximum Load Dual lb (kg) at psi (kPa) cold:** Indicates the maximum load and tire pressure when the tire is used as a dual, defined as four tires on the rear axle (a total of six or more tires on the vehicle).

**D. Maximum Load Single lb (kg) at psi (kPa) cold:** Indicates the maximum load and tire pressure when the tire is used as a single, defined as two tires (total) on the rear axle.

### Information on T Type Tires

T145/80D16 is an example of a tire size.

**Note:** *The temporary tire size for your vehicle may be different from this example. Tire Quality Grades do not apply to this type of tire.*

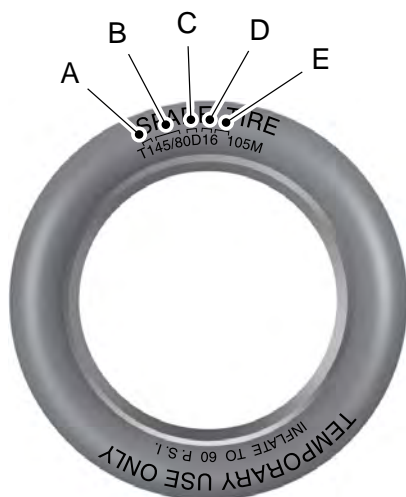

E142545

T type tires have some additional information beyond those of P type tires; these differences are described below:

**A. T:** Indicates a type of tire, designated by the Tire and Rim Association, that is intended for temporary service on cars, sport utility vehicles, minivans and light trucks.

**B. 145:** Indicates the nominal width of the tire in millimeters from sidewall edge to sidewall edge. In general, the larger the number, the wider the tire.

## Wheels and Tires

---

C. **80:** Indicates the aspect ratio which gives the tire's ratio of height to width. Numbers of 70 or lower indicate a short sidewall.

D. **D:** Indicates a diagonal type tire.

**R:** Indicates a radial type tire.

E. **16:** Indicates the wheel or rim diameter in inches. If you change your wheel size, you will have to purchase new tires to match the new wheel diameter.

### Recommended Tire Pressures and Inflating Your Tires

Safe operation of your vehicle requires that your tires are properly inflated. Remember that a tire can lose up to half of its air pressure without appearing flat. Every day before you drive, check your tires. If one looks lower than the others, use a tire gauge to check the pressure of all tires and adjust if required.

At least once a month and before long trips, inspect each tire and check the tire pressure with a tire gauge (including spare, if equipped). Inflate all tires to the inflation pressure recommended by Ford Motor Company.

### WARNING



Under-inflation is the most common cause of tire failures and may result in severe tire cracking, tread separation or blowout, with unexpected loss of vehicle control and increased risk of injury. Under-inflation increases sidewall flexing and rolling resistance, resulting in heat buildup and internal damage to the tire. It also may result in unnecessary tire stress, irregular wear, loss of vehicle control and accidents. A tire can lose up to half of its air pressure and not appear to be flat!

---

You are strongly urged to buy a reliable tire pressure gauge, as automatic service station gauges may be inaccurate. Ford recommends the use of a digital or dial-type tire pressure gauge rather than a stick-type tire pressure gauge. Use the recommended cold inflation pressure for optimum tire performance and wear. Under-inflation or over-inflation may cause uneven treadwear patterns.



# Wheels and Tires

Always inflate your tires to the Ford recommended inflation pressure even if it is less than the maximum inflation pressure information found on the tire. You will find a Tire Label containing the Ford recommended tire inflation pressure by the tire size and other important information located on the B-Pillar or the edge of the driver's door.

The Ford recommended tire inflation pressure is also found on the Safety Compliance Certification Label (affixed to either the door hinge pillar, door-latch post, or the door edge that meets the door-latch on the B-pillar, or on the edge of the driver's door.

Failure to follow the tire pressure recommendations can cause uneven treadwear patterns and adversely affect the way your vehicle handles.

## Inspecting Your Tires and Wheel Valve Stems

Periodically inspect the tire treads for uneven or excessive wear and remove objects such as stones, nails or glass that may be wedged in the tread grooves. Check the tire and valve stems for holes, cracks, or cuts that may permit air leakage and repair or replace the tire and replace the valve stem. Inspect the tire sidewalls for cracking, cuts, bruises and other signs of damage or excessive wear. If internal damage to the tire

is suspected, have the tire demounted and inspected in case it needs to be repaired or replaced. For your safety, tires that are damaged or show signs of excessive wear should not be used because they are more likely to blow out or fail.

Improper or inadequate vehicle maintenance can cause tires to wear abnormally. Inspect all your tires, including the spare, frequently, and replace them if one or more of the following conditions exist:

## Tire Wear

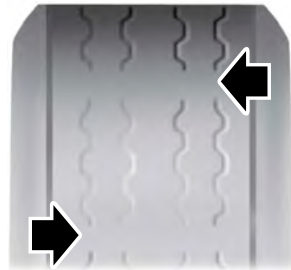

E142546

When the tread is worn down to one sixteenth of an inch (2 mm), tires must be replaced to help prevent your vehicle from skidding and hydroplaning. Built-in treadwear indicators, or wear bars, which look like narrow strips of smooth rubber across the tread will appear on the tire when the tread is worn down to one sixteenth of an inch (2 mm).

# Wheels and Tires

---

When the tire tread wears down to the same height as these wear bars, the tire is worn out and must be replaced.

## Damage

Periodically inspect the tire treads and sidewalls for damage (such as bulges in the tread or sidewalls, cracks in the tread groove and separation in the tread or sidewall). If damage is observed or suspected, have the tire inspected by a tire professional. Tires can be damaged during off-road use, so inspection after off-road use is also recommended.

## Age

### WARNING



Tires degrade over time depending on many factors such as weather, storage conditions, and conditions of use (load, speed, inflation pressure) the tires experience throughout their lives.

In general, tires should be replaced after six years regardless of tread wear. However, heat caused by hot climates or frequent high loading conditions can accelerate the aging process and may require tires to be replaced more frequently.

You should replace your spare tire when you replace the road tires or after six years due to aging even if it has not been used.

---

## U.S. DOT Tire Identification Number

Both United States and Canada Federal regulations require tire manufacturers to place standardized information on the sidewall of all tires. This information identifies and describes the fundamental characteristics of the tire and also provides a U.S. DOT Tire Identification Number for safety standard certification and in case of a recall.

# Wheels and Tires

This begins with the letters DOT and indicates that the tire meets all federal standards. The next two numbers or letters are the plant code designating where it was manufactured, the next two are the tire size code and the last four numbers represent the week and year the tire was built. For example, the numbers 317 mean the 31st week of 1997. After 2000, the numbers go to four digits. For example, 2501 means the 25th week of 2001. The numbers in between are identification codes used for traceability. This information is used to contact customers if a tire defect requires a recall.

## Tire Replacement Requirements

Your vehicle is equipped with tires designed to provide a safe ride and handling capability.

### WARNINGS

 Only use replacement tires and wheels that are the same size, load index, speed rating and type (such as P-metric versus LT-metric or all-season versus all-terrain) as those originally provided by Ford. The recommended tire and wheel size may be found on either the Safety Compliance Certification Label (affixed to either the door hinge pillar, door-latch post, or the door edge that meets the door-latch post, next to the driver's seating position), or the Tire Label which

### WARNINGS

is located on the B-Pillar or edge of the driver's door. If this information is not found on these labels, then you should contact your authorized dealer as soon as possible. Use of any tire or wheel not recommended by Ford can affect the safety and performance of your vehicle, which could result in an increased risk of loss of vehicle control, vehicle rollover, personal injury and death.



To reduce the risk of serious injury, when mounting replacement tires and wheels, you should not exceed the maximum pressure indicated on the sidewall of the tire to set the beads without additional precautions listed below. If the beads do not seat at the maximum pressure indicated, re-lubricate and try again.

When inflating the tire for mounting pressures up to 20 psi (1.38 bar) greater than the maximum pressure on the tire sidewall, the following precautions must be taken to protect the person mounting the tire:

1. Make sure that you have the correct tire and wheel size.
2. Lubricate the tire bead and wheel bead seat area again.

# Wheels and Tires

---

## WARNINGS

3. Stand at a minimum of 12 ft (3.66 m) away from the wheel and tire assembly.

4. Use both eye and ear protection.

For a mounting pressure more than 20 psi (1.38 bar) greater than the maximum pressure, a Ford dealer or other tire service professional should do the mounting.

Always inflate steel carcass tires with a remote air fill with the person inflating standing at a minimum of 12 ft (3.66 m) away from the wheel and tire assembly.

---

**Important:** Remember to replace the wheel valve stems when the road tires are replaced on your vehicle.

It is recommended that the two front tires or two rear tires generally be replaced as a pair.

The tire pressure sensors mounted in the wheels (originally installed on your vehicle) are not designed to be used in aftermarket wheels.

The use of wheels or tires not recommended by Ford Motor Company may affect the operation of your tire pressure monitoring system.

If the tire pressure monitoring system indicator is flashing, your system is malfunctioning. Your replacement tire might be incompatible with your tire pressure monitoring system, or some component of the system may be damaged.

## Safety Practices

### WARNINGS



If your vehicle is stuck in snow, mud or sand, do not rapidly spin the tires; spinning the tires can tear the tire and cause an explosion. A tire can explode in as little as three to five seconds.



Do not spin the wheels at over 34 mph (55 km/h). The tires may fail and injure a passenger or bystander.

---

## Driving habits have a great deal to do with your tire mileage and safety.

- \*Observe posted speed limits
- \*Avoid fast starts, stops and turns
- \*Avoid potholes and objects on the road
- \*Do not run over curbs or hit the tire against a curb when parking

# Wheels and Tires

---

## Highway Hazards

No matter how carefully you drive, there is always the possibility that you may eventually have a flat tire on the highway. Drive slowly to the closest safe area out of traffic. This may further damage the flat tire, but your safety is more important.

If you feel a sudden vibration or ride disturbance while driving, or you suspect your tire or vehicle has been damaged, immediately reduce your speed. Drive with caution until you can safely pull off the road. Stop and inspect the tires for damage. If a tire is under-inflated or damaged, deflate it, remove wheel and replace it with your spare tire and wheel. If you cannot detect a cause, have the vehicle towed to the nearest repair facility or tire dealer to have the vehicle inspected.

## Tire and Wheel Alignment

A bad jolt from hitting a curb or pothole can cause the front end of your vehicle to become misaligned or cause damage to your tires. If your vehicle seems to pull to one side when you are driving, the wheels may be out of alignment. Have an authorized dealer check the wheel alignment periodically.

Wheel misalignment in the front or the rear can cause uneven and rapid treadwear of your tires and should be corrected by an authorized dealer. Front-wheel drive vehicles and those with an independent rear suspension (if equipped) may require alignment of all four wheels.

The tires should also be balanced periodically. An unbalanced tire and wheel assembly may result in irregular tire wear.

## Tire Rotation

**Note:** *If your tires show uneven wear, ask an authorized dealer to check for and correct any wheel misalignment, tire imbalance or mechanical problem involved before tire rotation.*

**Note:** *Your vehicle may be equipped with a dissimilar spare wheel and tire assembly. A dissimilar spare wheel and tire assembly is defined as a spare wheel and tire assembly that is different in brand, size or appearance from the road tires and wheels. If you have a dissimilar spare wheel and tire assembly, it is intended for temporary use only and should not be used in a tire rotation.*

**Note:** *After having your tires rotated, inflation pressure must be checked and adjusted to the vehicle requirements.*

# Wheels and Tires

Rotating your tires at the recommended interval (as indicated in the Scheduled Maintenance chapter) will help your tires wear more evenly, providing better tire performance and longer tire life. Sometimes irregular tire wear can be corrected by rotating the tires.

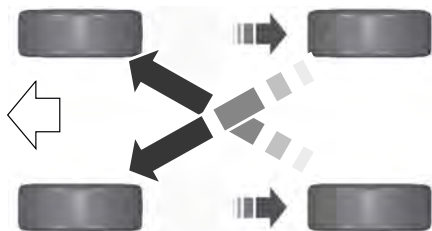

E142547

## USING SUMMER TIRES

Summer tires provide superior performance on wet and dry roads. Summer tires do not have the Mud and Snow (M+S or M/S) tire traction rating on the tire side wall. Since summer tires do not have the same traction performance as All-season or Snow tires, we do not recommend using summer tires when temperatures drop to approximately 45°F (7°C) or below (depending on tire wear and environmental conditions) or in snow and ice conditions. Like any tire, summer tire performance is affected by tire wear and environmental conditions. If you must drive in those conditions, we recommend using Mud and Snow (M+S, M/S), All-season or Snow tires.

Always store your summer tires indoors at temperatures above 20°F (-7°C). The rubber compounds used in these tires lose flexibility and may develop surface cracks in the tread area at temperatures below 20°F (-7°C). If the tires have been subjected to 20°F (-7°C) or less, warm them in a heated space to at least 40°F (5°C) for at least 24 hours before installing them on a vehicle, or moving the vehicle with the tires installed, or checking tire inflation. Do not place tires near heaters or heating devices used to warm the room where the tires are stored. Do not apply heat or blow heated air directly on the tires. Always inspect the tires after storage periods and before use.

## USING SNOW CHAINS

### WARNING



Snow tires must be the same size, load index, and speed rating as those originally provided by Ford. Use of any tire or wheel not recommended by Ford can affect the safety and performance of your vehicle, which could result in an increased risk of loss of vehicle control, vehicle rollover, personal injury, and death. Additionally, the use of non-recommended tires and wheels could cause steering, suspension, axle, transfer case, or power transfer unit failure. It is also strongly advised to follow the Ford recommended tire inflation pressure found on the Safety Compliance Certification Label (affixed to either the door hinge pillar, door-latch post, or the door edge that meets the door-latch post, next to the driver's seating position), or Tire Label which is located on the B-Pillar or the edge of the driver door. Failure to follow the tire pressure recommendations can cause uneven treadwear patterns and adversely affect the way your vehicle handles.

# Wheels and Tires

The tires on your vehicle (excluding the 265/45ZR20 Sport Tire) may have all-weather treads to provide traction in rain and snow. However, in some climates you may need to use snow chains.

Your vehicle may not be compatible with snow chain or cable usage with the factory-fitted wheels and tires. Only certain chains or snow cables have been approved by Ford as safe for use on your vehicle with the following wheel and tire combination(s): 18"x8"x44mm Wheel and P245/60 R18 Tire. You should only install chains or cables that have been rated as 10 mm or less in dimension as measured on the sidewall of your tire. Not all S-class snow chains meet these restrictions.

Chains of this size restriction will include a tensioning device. The chains should be mounted in pairs on the front tires only. If you need to use chains, it is recommended that steel wheels (of the same size and specification) be used, as chains may chip aluminum wheels.

Follow these guidelines when using snow tires and traction devices

- If possible, avoid fully loading your vehicle
- Purchase chains or cables from a manufacturer that clearly labels body to tire dimension restrictions.
- When driving with tire cables do not exceed 30 mph (48 km/h) or the maximum speed recommended by the chain manufacturer, whichever is less.
- Drive cautiously. If you hear the cables rub or bang against the vehicle, stop and retighten them. If this does not work, remove the cables to prevent vehicle damage.

- Remove the cables when they are no longer needed. Do not use cables on dry roads.
- If a temporary spare wheel is mounted on your vehicle, do not use snow chains on the axle with the temporary spare tire.

If you have any questions regarding snow chains or cables, please contact your authorized dealer.

## TIRE PRESSURE MONITORING SYSTEM

### WARNING



The tire pressure monitoring system is not a substitute for manually checking tire pressure. The tire pressure should be checked periodically (at least monthly) using a tire gauge, see Inflating your tires in this chapter. Failure to properly maintain your tire pressure could increase the risk of tire failure, loss of control, vehicle rollover and personal injury.



Each tire, including the spare (if provided), should be checked monthly when cold and inflated to the inflation pressure recommended by the vehicle manufacturer on the vehicle placard or tire inflation pressure label. (If your vehicle has tires of a different size than the size indicated on the vehicle placard or tire inflation pressure label, you should determine the proper tire inflation pressure for those tires.)

As an added safety feature, your vehicle has been equipped with a Tire Pressure Monitoring System (TPMS) that illuminates a low tire pressure telltale when one or more of your tires is significantly under-inflated. Accordingly, when the low tire pressure telltale

# Wheels and Tires

illuminates, you should stop and check your tires as soon as possible, and inflate them to the proper pressure. Driving on a significantly under-inflated tire causes the tire to overheat and can lead to tire failure. Under-inflation also reduces fuel efficiency and tire tread life, and may affect the vehicle's handling and stopping ability.

Please note that the TPMS is not a substitute for proper tire maintenance, and it is the driver's responsibility to maintain correct tire pressure, even if under-inflation has not reached the level to trigger illumination of the TPMS low tire pressure telltale.

Your vehicle has also been equipped with a TPMS malfunction indicator to indicate when the system is not operating properly. The TPMS malfunction indicator is combined with the low tire pressure telltale. When the system detects a malfunction, the telltale will flash for approximately one minute and then remain continuously illuminated. This sequence will continue upon subsequent vehicle start-ups as long as the malfunction exists.

When the malfunction indicator is illuminated, the system may not be able to detect or signal low tire pressure as intended. TPMS malfunctions may occur for a variety of reasons, including the installation of replacement or alternate tires or wheels on the vehicle that prevent the TPMS from functioning properly. Always check the TPMS malfunction telltale after replacing one or more tires or wheels on your vehicle to ensure that the replacement or alternate tires and wheels allow the TPMS to continue to function properly.

The tire pressure monitoring system complies with part 15 of the FCC rules and with RSS-210 of Industry Canada. Operation is subject to the following two conditions: (1) This device may not cause harmful interference, and (2) This device must accept any interference received, including interference that may cause undesired operation.

## Changing Tires With a Tire Pressure Monitoring System



E142549

**Note:** Each road tire is equipped with a tire pressure sensor located inside the wheel and tire assembly cavity. The pressure sensor is attached to the valve stem. The pressure sensor is covered by the tire and is not visible unless the tire is removed. Take care when changing the tire to avoid damaging the sensor

You should always have your tires serviced by an authorized dealer.

Check the tire pressure periodically (at least monthly) using an accurate tire gauge. See *Inflating Your Tires* in this chapter.



# Wheels and Tires

---

## **Understanding Your Tire Pressure Monitoring System**

The tire pressure monitoring system measures pressure in your four road tires and sends the tire pressure readings to your vehicle. The low tire pressure warning light will turn on if the tire pressure is significantly low. Once the light is illuminated, your tires are under-inflated and need to be inflated to the manufacturer's recommended tire pressure. Even if the light turns on and a short time later turns off, your tire pressure still needs to be checked.

## **When Your Temporary Spare Tire is Installed**

When one of your road tires needs to be replaced with the temporary spare, the system will continue to identify an issue to remind you that the damaged road wheel and tire assembly needs to be repaired and put back on your vehicle.

To restore the full function of the tire pressure monitoring system, have the damaged road wheel and tire assembly repaired and remounted on your vehicle.

## **When You Believe Your System is Not Operating Properly**

The main function of the tire pressure monitoring system is to warn you when your tires need air. It can also warn you in the event the system is no longer capable of functioning as intended. See the following chart for information concerning your tire pressure monitoring system:

# Wheels and Tires

| Low tire pressure warning light | Possible cause         | Customer action required  |
|---------------------------------|------------------------|---|
| Solid warning light             | Tire(s) under-inflated | Make sure tires are at the proper pressure. See <b>Inflating your tires</b> in this chapter. After inflating your tires to the manufacturer's recommended pressure as shown on the Tire Label (located on the edge of driver's door or the B-Pillar), the vehicle must be driven for at least two minutes over 20 mph (32 km/h) before the light turns off. |
|                                 | Spare tire in use      | Repair the damaged road wheel and tire assembly and reinstall it on the vehicle to restore system function. For a description on how the system functions, see <b>When your temporary spare tire is installed</b> in this section.  |
|                                 | TPMS malfunction       | If the tires are properly inflated and the spare tire is not in use but the light remains on, contact your authorized dealer as soon as possible.   |
| Flashing warning light          | Spare tire in use      | Repair the damaged road wheel and tire assembly and reinstall it on the vehicle to restore system function. For a description on how the system functions, see <b>When your temporary spare tire is installed</b> in this section.  |
|                                 | TPMS malfunction       | If the tires are properly inflated and the spare tire is not in use but the light remains on, contact your authorized dealer as soon as possible.   |

## When Inflating Your Tires

When putting air into your tires (such as at a gas station or in your garage), the tire pressure monitoring system may not respond immediately to the air added to your tires.

It may take up to two minutes of driving over 20 mph (32 km/h) for the light to turn off after you have filled your tires to the recommended inflation pressure

# Wheels and Tires

## How Temperature Affects Your Tire Pressure

The tire pressure monitoring system monitors tire pressure in each pneumatic tire. While driving in a normal manner, a typical passenger tire inflation pressure may increase about 2 to 4 psi (14 to 28 kPa) from a cold start situation. If the vehicle is stationary overnight with the outside temperature significantly lower than the daytime temperature, the tire pressure may decrease about 3 psi (21 kPa) for a drop of 30°F (17°C) in ambient temperature. This lower pressure value may be detected by the tire pressure monitoring system as being significantly lower than the recommended inflation pressure and activate the system warning light for low tire pressure. If the low tire pressure warning light is on, visually check each tire to verify that no tire is flat. If one or more tires are flat, repair as necessary. Check the air pressure in the road tires. If any tire is under-inflated, carefully drive the vehicle to the nearest location where air can be added to the tires. Inflate all the tires to the recommended inflation pressure.

## CHANGING A ROAD WHEEL

### WARNINGS



The use of tire sealant may damage your tire pressure monitoring system and should only be used in roadside emergencies. If you must use a sealant, the Ford Tire Mobility Kit sealant should be used. The tire pressure monitoring system sensor and valve stem on the wheel must be replaced by an authorized dealer after use of the sealant.



See **Tire Pressure Monitoring System** (page 321). If the tire pressure monitor sensor becomes damaged, it will no longer function.

**Note:** *The tire pressure monitoring system indicator light will illuminate when the spare tire is in use. To restore the full function of the monitoring system, all road wheels equipped with tire pressure monitoring sensors must be mounted on the vehicle.*

If you get a flat tire while driving, do not apply the brake heavily. Instead, gradually decrease your speed. Hold the steering wheel firmly and slowly move to a safe place on the side of the road.

Have a flat serviced by an authorized dealer in order to prevent damage to the tire pressure monitoring system sensors. See **Tire Pressure Monitoring System** (page 321). Replace the spare tire with a road tire as soon as possible. During repairing or replacing of the flat tire, have the authorized dealer inspect the tire pressure monitoring system sensor for damage.

## Dissimilar Spare Wheel and Tire Assembly Information

### WARNING



Failure to follow these guidelines could result in an increased risk of loss of vehicle control, injury or death.

If you have a dissimilar spare wheel and tire, then it is intended for temporary use only. This means that if you need to use it, you should replace it as soon as possible with a road wheel and tire assembly that is the same size and type as the road tires and wheels that were originally provided by Ford. If the dissimilar spare tire or wheel is damaged, it should be replaced rather than repaired.

A dissimilar spare wheel and tire assembly is defined as a spare wheel and tire assembly that is different in brand, size or appearance from the road tires and wheels and can be one of three types:

# Wheels and Tires

1. **T-type mini-spare:** This spare tire begins with the letter T for tire size and may have Temporary Use Only molded in the sidewall.

2. **Full-size dissimilar spare with label on wheel:** This spare tire has a label on the wheel that states: THIS WHEEL AND TIRE ASSEMBLY FOR TEMPORARY USE ONLY.

When driving with one of the dissimilar spare tires listed above, do not:

- Exceed 50 mph (80 km/h).
- Load the vehicle beyond maximum vehicle load rating listed on the Safety Compliance Label.
- Tow a trailer.
- Use snow chains on the end of the vehicle with the dissimilar spare tire.
- Use more than one dissimilar spare tire at a time.
- Use commercial car washing equipment.
- Try to repair the dissimilar spare tire.

Use of one of the dissimilar spare tires listed above at any one wheel location can lead to impairment of the following:

- Handling, stability and braking performance.
- Comfort and noise.
- Ground clearance and parking at curbs.
- Winter weather driving capability.
- Wet weather driving capability.
- All-wheel driving capability.

3. **Full-size dissimilar spare without label on wheel**

When driving with the full-size dissimilar spare wheel and tire assembly, do not:

- Exceed 70 mph (113 km/h).
- Use more than one dissimilar spare wheel and tire assembly at a time.

- Use commercial car washing equipment.
- Use snow chains on the end of the vehicle with the dissimilar spare wheel and tire assembly.

The usage of a full-size dissimilar spare wheel and tire assembly can lead to impairment of the following:

- Handling, stability and braking performance.
- Comfort and noise.
- Ground clearance and parking at curbs.
- Winter weather driving capability.
- Wet weather driving capability.
- All-wheel driving capability.

When driving with the full-size dissimilar spare wheel and tire assembly additional caution should be given to:

- Towing a trailer.
- Driving vehicles equipped with a camper body.
- Driving vehicles with a load on the cargo rack.

Drive cautiously when using a full-size dissimilar spare wheel and tire assembly and seek service as soon as possible.

## Tire Change Procedure

### WARNINGS



When one of the front wheels is off the ground, the transmission alone will not prevent your vehicle from moving or slipping off the jack, even if the transmission is in park (P) or neutral (N).





To help prevent your vehicle from moving when you change a tire, be sure to place the transmission in park (P) or neutral (N), set the parking brake, and block (in both directions) the wheel that is diagonally opposite (other side and end of your vehicle) to the tire being changed.

# Wheels and Tires

## WARNINGS

 Never get underneath a vehicle that is supported only by a jack. If the vehicle slips off the jack, you or someone else could be seriously injured.

 Do not attempt to change a tire on the side of the vehicle close to moving traffic. Pull far enough off the road to avoid the danger of being hit when operating the jack or changing the wheel.

 Always use the jack provided as original equipment with your vehicle. If using a jack other than the one provided as original equipment with your vehicle, make sure the jack capacity is adequate for the vehicle weight, including any vehicle cargo or modifications.

 To reduce the risk of possible serious injury or death, do not remove the full size spare tire from the factory secured location. This location is necessary to achieve police-rated 75 mph rear impact crash-test performance. Removal increases the risk of fuel leak in high-speed rear impacts.

**Note:** *Passengers should not remain in your vehicle when the vehicle is being jacked.*

**Note:** *Jack at the specified locations to avoid damage to the vehicle.*

1. Park on a level surface, set the parking brake and activate the hazard flashers.
2. Place the transmission in park (P) and turn the engine off.

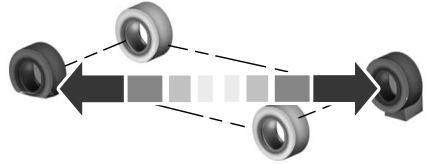

E142551

3. Block the diagonally opposite wheel.



E194295

4. Turn the two knobs on the floor filler counterclockwise, then remove the floor filler and carpeted floor panel located in the rear of the vehicle.

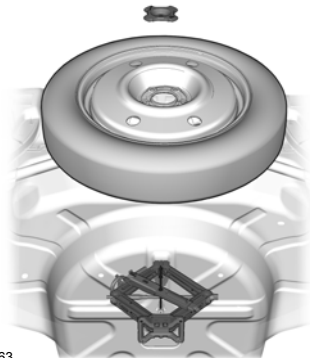

E226763

# Wheels and Tires

5. Remove the wing nut securing the spare tire by turning it counterclockwise.
6. Remove the spare tire from the spare tire well.
7. Remove the wing nut bolt that secures the jack kit by turning it counterclockwise.
8. Remove the jack kit, which includes the jack, lug wrench, L-shaped bolt and tow recovery hook.
9. Turn the lead screw (where the lug wrench attaches) of the jack by hand to release the lug wrench from the jack. Press the button on the wrench to extend the handle. Fold down the wrench socket.
10. Loosen each wheel lug nut one-half turn counterclockwise, but do not remove them until the wheel is raised off the ground.



E145908

11. The vehicle jacking points are shown here, and are depicted on the warning label on the jack.
12. Small arrow-shaped marks on the sills show the location of the jacking points.



E201156

13. Raise the wheel by turning the jack handle clockwise.
14. Remove the lug nuts with the lug wrench.
15. Replace the flat tire with the spare tire, marking sure the valve stem is facing outward. Reinstall the lug nuts until the wheel is snug against the hub. Do not fully tighten the lug nuts until the wheel has been lowered.
16. Lower the wheel by turning the jack handle counterclockwise.

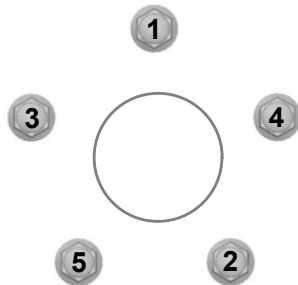

E75442

17. Remove the jack and fully tighten the lug nuts in the order shown. See **Technical Specifications** (page 330).

# Wheels and Tires

## Stowing the flat tire

1. Stand the flat tire vertically in the mini-spare tub with the tire's valve stem facing rearward toward the luggage compartment.

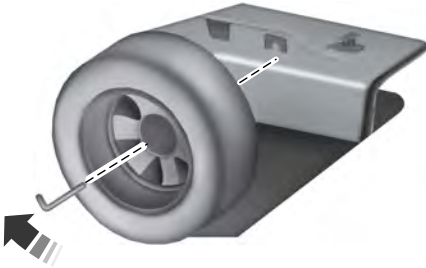

E194296

2. Fasten the flat tire to the luggage compartment back panel by inserting the L-shaped bolt through one of the lug bolt holes in the wheel.

3. Turn the L-shaped bolt clockwise into the threaded hole in the luggage compartment back panel until the tire is secured.
4. Unblock the diagonally opposite wheel.

## Stowing the jack

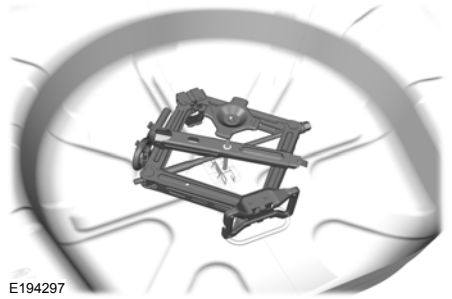

E194297

With the road wheel in the vertical position in the spare tire tub, the jack assembly will not fit in its standard position. Secure the jack in the alternate position by inserting the wing bolt through the jack as shown.

# Wheels and Tires

## TECHNICAL SPECIFICATIONS

### Wheel Lug Nut Torque Specifications

#### WARNING



When a wheel is installed, always remove any corrosion, dirt or foreign materials present on the mounting surfaces of the wheel or the surface of the wheel hub, brake drum or brake disc that contacts the wheel. Make sure that any fasteners that attach the rotor to the hub are secured so they do not interfere with the mounting surfaces of the wheel. Installing wheels without correct metal-to-metal contact at the wheel mounting surfaces can cause the wheel nuts to loosen and the wheel to come off while your vehicle is in motion, resulting in loss of control.

| Bolt size    | lb-ft (Nm)* |
|--------------|-------------|
| 1/2-20 x 1.5 | 100 (135)   |

\*Torque specifications are for nut and bolt threads free of dirt and rust. Use only Ford recommended replacement fasteners.

Retighten the lug nuts to the specified torque within 100 miles (160 kilometers) after any wheel disturbance (such as tire rotation, changing a flat tire, wheel removal).



E145950

A Wheel pilot bore

Inspect the wheel pilot bore and mounting surface prior to installation. Remove any visible corrosion or loose particles.



# Capacities and Specifications

## ENGINE SPECIFICATIONS - 2.3L ECOBOOST™

| Engine            | 2.3L EcoBoost                     |
|-------------------|-----------------------------------|
| Cubic inches      | 138                               |
| Required fuel     | Minimum 87 octane                 |
| Firing order      | 1-3-4-2                           |
| Ignition system   | Coil on plug                      |
| Spark plug gap    | 0.027 - 0.031 in (0.70 - 0.80 mm) |
| Compression ratio | 9.5:1                             |

### Drivebelt Routing

#### 2.3L EcoBoost Engine

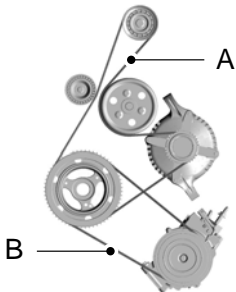

E161383

- A. Long drivebelt is on first pulley groove closest to engine.
- B. Short drivebelt is on second pulley groove farthest from engine.

# Capacities and Specifications

## ENGINE SPECIFICATIONS - 3.5L DURATEC

| Engine            | 3.5L V6                              |
|-------------------|--------------------------------------|
| Cubic inches      | 214                                  |
| Required fuel     | Minimum 87 octane                    |
| Firing order      | 1-4-2-5-3-6                          |
| Ignition system   | Coil on plug                         |
| Spark plug gap    | 0.049 - 0.053 in (1.25 mm - 1.35 mm) |
| Compression ratio | 10.8:1                               |

## Drivebelt Routing

### 3.5L Engine

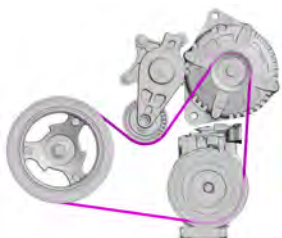

E191904

## ENGINE SPECIFICATIONS - 3.5L ECOBOOST™

| Engine            | 3.5L EcoBoost                        |
|-------------------|--------------------------------------|
| Cubic inches      | 214                                  |
| Required fuel     | Minimum 87 octane                    |
| Firing order      | 1-4-2-5-3-6                          |
| Ignition system   | Coil on plug                         |
| Spark plug gap    | 0.033 - 0.037 in (0.75 mm - 0.85 mm) |
| Compression ratio | 10.0:1                               |

# Capacities and Specifications

## Drivebelt Routing

## 3.5L EcoBoost Engine

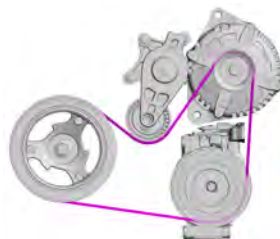

E191904

## MOTORCRAFT PARTS - 2.3L ECOBOOST™

| Component               | Part Number                                       |
|-------------------------|---|
| Air filter element      | FA-1884   |
| Oil filter              | FL-910-S  |
| Battery                 | BXT-59<br>BXT-65-650*                             |
| Spark plugs             | SP-537  |
| Cabin air filter        | FP-68   |
| Windshield wiper blade  | WW-2600 (driver side)<br>WW-2206 (passenger side) |
| Rear window wiper blade | WW-1106   |

\*This Motorcraft part is designed for vehicles with Intelligent Access.

We recommend Motorcraft replacement parts available at your Ford dealer or at [fordparts.com](http://fordparts.com) for scheduled maintenance. These parts meet or exceed Ford Motor Company's specifications and are engineered for your vehicle. Use of other parts may impact vehicle performance, emissions and durability. Your warranty may be void for any damage related to use of other parts.

If a Motorcraft oil filter is not available, use an oil filter that meets industry performance specification SAE/USCAR-36.

For spark plug replacement, contact an authorized dealer. Replace the spark plugs at the appropriate intervals. See **Scheduled Maintenance** (page 483).

## Capacities and Specifications

---

### MOTORCRAFT PARTS - 3.5L DURATEC

| Component               | Part Number                                       |
|-------------------------|---|
| Air filter element      | FA-1884   |
| Oil filter              | FL-500-S  |
| Battery                 | BXT-59<br>BXT-65-650*                             |
| Spark plugs             | SP-520  |
| Cabin air filter        | FP-68   |
| Windshield wiper blade  | WW-2600 (driver side)<br>WW-2206 (passenger side) |
| Rear window wiper blade | WW-1106   |

\*This Motorcraft part is designed for vehicles with Intelligent Access.

We recommend Motorcraft replacement parts available at your Ford dealer or at [fordparts.com](http://fordparts.com) for scheduled maintenance. These parts meet or exceed Ford Motor Company's specifications and are engineered for your vehicle. Use of other parts may impact vehicle performance, emissions and durability. Your warranty may be void for any damage related to use of other parts.

If a Motorcraft oil filter is not available, use an oil filter that meets industry performance specification SAE/USCAR-36.

For spark plug replacement, contact an authorized dealer. Replace the spark plugs at the appropriate intervals. See **Scheduled Maintenance** (page 483).

## Capacities and Specifications

### MOTORCRAFT PARTS - 3.5L ECOBOOST™

| Component               | Part Number                                       |
|-------------------------|---|
| Air filter element      | FA-1884   |
| Oil filter              | FL-500-S  |
| Battery                 | BXT-59<br>BXT-65-650*                             |
| Spark plugs             | SP-534  |
| Cabin air filter        | FP-68   |
| Windshield wiper blade  | WW-2600 (driver side)<br>WW-2206 (passenger side) |
| Rear window wiper blade | WW-1106   |

\*This Motorcraft part is designed for vehicles with Intelligent Access.

We recommend Motorcraft replacement parts available at your Ford dealer or at [fordparts.com](http://fordparts.com) for scheduled maintenance. These parts meet or exceed Ford Motor Company's specifications and are engineered for your vehicle. Use of other parts may impact vehicle performance, emissions and durability. Your warranty may be void for any damage related to use of other parts.

If a Motorcraft oil filter is not available, use an oil filter that meets industry performance specification SAE/USCAR-36.

For spark plug replacement, contact an authorized dealer. Replace the spark plugs at the appropriate intervals. See **Scheduled Maintenance** (page 483).

# Capacities and Specifications

## VEHICLE IDENTIFICATION NUMBER

The vehicle identification number is located on the left-hand side of the instrument panel.

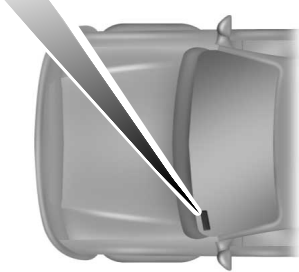

E142476

Please note that in the graphic, XXXX is representative of your vehicle identification number.

The Vehicle Identification Number contains the following information:

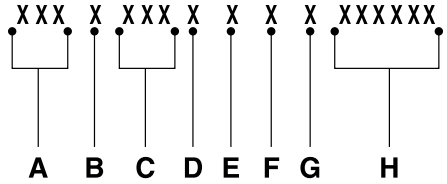

E142477

- A World manufacturer identifier
- B Brake system, Gross Vehicle Weight Rating, Restraint Devices and their locations
- C Make, vehicle line, series, body type
- D Engine type
- E Check digit
- F Model year
- G Assembly plant
- H Production sequence number

# Capacities and Specifications

## VEHICLE CERTIFICATION LABEL

**MFD. BY FORD MOTOR CO.**

DATE: XX/XX      GVWR: XXXX KG (XXXX LB)  
 FRONT GAWR:      REAR GAWR:  
 XXXX KG (XXXX LB)      WITH XXXX KG (XXXX LB)      WITH  
 XXXXXXXXXXXXXXXX      TIRES XXXXXXXXXXXXXXXX      TIRES  
 XXXXXXXX      RIMS XXXXXXXX      RIMS  
 AT XXXX kPa/ XXX PSI COLD      AT XXXX kPa/ XXX PSI COLD

THIS VEHICLE CONFORMS TO ALL APPLICABLE FEDERAL MOTOR VEHICLE SAFETY AND THEFT PREVENTION STANDARDS IN EFFECT ON THE DATE OF MANUFACTURE SHOWN ABOVE.

VIN: XXXXXXXXXXXXXXXX      XXXXX  
 TYPE: XXXX      XXXXX



EXT PNT: XX      XXXXX      RC: XX      DSO: XXXX  
 WB INT TR TP/PS I R AXLE I TR SPR I XXXX  
 XXX XX      XXX X XX X XXXX XXXX  
 XXXXXXXXXXXXXXXX      XXX      XXXX-XXXXXXXX-XX

E167469

The National Highway Traffic Safety Administration Regulations require that a Safety Compliance Certification Label be affixed to a vehicle and prescribe where the Safety Compliance Certification Label may be located. The Safety Compliance Certification Label shall be affixed to either the door hinge pillar, the door latch post, or the edge of the door near the door latch, next to the driver's seating position.

## TRANSMISSION CODE DESIGNATION

**MFD. BY FORD MOTOR CO.**

DATE: XX/XX      GVWR: XXXX KG (XXXX LB)  
 FRONT GAWR:      REAR GAWR:  
 XXXX KG (XXXX LB)      WITH XXXX KG (XXXX LB)      WITH  
 XXXXXXXXXXXXXXXX      TIRES XXXXXXXXXXXXXXXX      TIRES  
 XXXXXXXX      RIMS XXXXXXXX      RIMS  
 AT XXXX kPa/ XXX PSI COLD      AT XXXX kPa/ XXX PSI COLD

THIS VEHICLE CONFORMS TO ALL APPLICABLE FEDERAL MOTOR VEHICLE SAFETY AND THEFT PREVENTION STANDARDS IN EFFECT ON THE DATE OF MANUFACTURE SHOWN ABOVE.

VIN: XXXXXXXXXXXXXXXX      XXXXX  
 TYPE: XXXX      XXXXX



EXT PNT: XX      XXXXX      RC: XX      DSO: XXXX  
 WB INT TR TP/PS I R AXLE I TR SPR I XXXX  
 XXX XX      XXX X XX X XXXX XXXX  
 XXXXXXXXXXXXXXXX      XX      =XXXX-XXXXXXXX-XX

E167814

The transmission code is on the Safety Compliance Certification Label. The following table shows the transmission code along with the transmission description.

| Description                           | Code |
|---------------------------------------|------|
| Six-speed automatic transmission 6F35 | 6    |
| Six-speed automatic transmission 6F55 | C    |
| Six-speed automatic transmission 6F50 | J    |

# Capacities and Specifications

## CAPACITIES AND SPECIFICATIONS - 2.3L ECOBOOST™

### Capacities

#### WARNING



The air conditioning refrigerant system contains refrigerant under high pressure. Only qualified personnel should service the air conditioning refrigerant system. Opening the air conditioning refrigerant system can cause personal injury.

| Item   | Capacity                                 |
|--|--|
| Engine oil (with oil filter)                       | 5.7 qt (5.4 L)                           |
| Engine coolant                                     | 11.6 qt (11 L)                           |
| Brake fluid  | Between MIN/MAX on brake fluid reservoir |
| Rear axle fluid                                    | 2.4 pt (1.15 L)                          |
| Automatic transmission fluid                       | 9.0 qt (8.5 L) *                         |
| Power Transfer Unit (PTU) fluid (Four-wheel drive) | 23.7 fl oz (700 ml)                      |
| Windshield washer fluid                            | Fill as required                         |
| Fuel tank  | 18.6 gal (70.4 L)                        |
| A/C refrigerant                                    | 2.81 lb (1.276 kg)                       |
| A/C refrigerant compressor oil                     | 7.3 fl oz (215 ml)                       |

\* Approximate dry fill capacity. Actual amount may vary during fluid changes.

### Specifications

#### Materials

| Name  | Specification |
|---|---------------|
| Recommended motor oil (U.S.):<br>Motorcraft® SAE 5W-30 Premium Synthetic Blend Motor Oil<br>XO-5W30-QSP | WSS-M2C946-A  |
| Recommended Motor oil (Canada):<br>Motorcraft® SAE 5W-30 Super Premium Motor Oil<br>CXO-5W30-LSP12      | WSS-M2C946-A  |
| Recommended motor oil (Mexico):   | WSS-M2C946-A  |



## Capacities and Specifications

| Name  | Specification             |
|---|---------------------------|
| Motorcraft® SAE 5W-30 Synthetic Motor Oil<br>MXO-5W30-QSP   |                           |
| Optional motor oil (U.S. and Mexico):<br>Motorcraft® SAE 5W-30 Full Synthetic Motor Oil<br>XO-5W30-QFS  | WSS-M2C946-A              |
| Optional Motor oil (Canada):<br>Motorcraft® SAE 5W-30 Synthetic Motor Oil<br>CXO-5W30-LFS12   | WSS-M2C946-A              |
| Engine coolant (U.S. and Mexico):<br>Motorcraft® Orange Antifreeze/Coolant Prediluted<br>VC-3DIL-B  | WSS-M97B44-D2             |
| Engine coolant (Canada):<br>Motorcraft® Orange Antifreeze/Coolant Prediluted<br>CVC-3DIL-B  | WSS-M97B44-D2             |
| Brake fluid:<br>Motorcraft® DOT 4 Low Viscosity (LV) High Performance<br>Motor Vehicle Brake Fluid<br>PM-20                                     | WSS-M6C65-A2              |
| Rear axle fluid (U.S. and Mexico)<br>Motorcraft® SAE 80W-90 Premium Rear Axle Lubricant<br>XY-80W90-QL  | WSP-M2C197-A              |
| Rear axle fluid (Canada)<br>Motorcraft® SAE 80W-90 Premium Rear Axle Lubricant<br>CXY-80W90-1L  | WSP-M2C197-A              |
| Automatic transmission fluid (U.S. and Mexico):<br>Motorcraft® MERCON LV Automatic Transmission Fluid<br>XT-10-QLVC                             | WSS-M2C938-A<br>MERCON LV |
| Automatic transmission fluid (Canada):<br>Motorcraft® MERCON LV Automatic Transmission Fluid<br>CXT-10-LV12                                     | WSS-M2C938-A<br>MERCON LV |
| Power Transfer Unit (PTU) fluid (All Wheel Drive) (U.S.<br>and Mexico)<br>Motorcraft® SAE 75W-140 Synthetic Rear Axle Lubricant<br>XY-75W140-QL | WSL-M2C192-A              |
| Power Transfer Unit (PTU) fluid (All Wheel Drive)<br>(Canada)<br>Motorcraft® SAE 75W-140 Synthetic Rear Axle Lubricant<br>CXY-75W140-1L         | WSL-M2C192-A              |

## Capacities and Specifications

| Name  | Specification |
|---|---------------|
| Windshield washer fluid (U.S. and Mexico):<br>Motorcraft® Premium Windshield Wash Concentrate<br>with Bitterant<br>ZC-32-B2 | WSS-M14P19-A  |
| Windshield washer fluid (Canada):<br>Motorcraft® Premium Quality Windshield Washer Fluid<br>CXC-37-(A, B, D, F)             | WSS-M14P19-A  |
| A/C refrigerant (U.S.):<br>Motorcraft® R-134a Refrigerant<br>YN-19  | WSH-M17B19-A  |
| A/C refrigerant (Canada):<br>Motorcraft® R-134a Refrigerant<br>CYN-16-R   | WSH-M17B19-A  |
| A/C refrigerant (Mexico):<br>Motorcraft® R-134a Refrigerant<br>MYN-19   | WSH-M17B19-A  |
| A/C refrigerant compressor oil:<br>Motorcraft® PAG Refrigerant Compressor Oil<br>YN-12-D                                    | WSH-M1C231-B  |
| Transmission, parking brake linkage and pivots and brake<br>pedal shift grease:<br>Premium Long-Life Grease<br>XG-1-E1      | ESA-M1C75-B   |
| Multi-purpose grease:<br>Motorcraft® Multi-Purpose Grease Spray<br>XL-5   | ESB-M1C93-B   |
| Lock cylinders (U.S.):<br>Penetrating and Lock Lubricant<br>XL-1  | --            |
| Lock cylinders (Canada):<br>Penetrating Fluid<br>CXC-51-A   | --            |
| Lock cylinders (Mexico):<br>Penetrating and Lock Lubricant<br>MXL-1   | --            |

# Capacities and Specifications

If you use oil and fluids that do not meet the defined specification and viscosity grade, this may lead to:

- Component damage which is not covered by the vehicle warranty.
- Longer engine cranking periods.
- Increased emission levels.
- Reduced engine performance.
- Reduced fuel economy.
- Degraded brake performance.

We recommend Motorcraft® motor oil for your vehicle. If Motorcraft® oil is not available, use motor oils of the recommended viscosity grade that meet API SN requirements and display the API Certification Mark for gasoline engines. Do not use oil labeled with API SN service category unless the label also displays the API certification mark.



E142732

## CAPACITIES AND SPECIFICATIONS - 3.5L DURATEC

### Capacities

#### WARNING



The air conditioning refrigerant system contains refrigerant under high pressure. Only qualified personnel should service the air conditioning refrigerant system. Opening the air conditioning refrigerant system can cause personal injury.

An oil that displays this symbol conforms to current engine, emission system and fuel economy performance standards of the International Lubricants Specification Advisory Committee (ILSAC).

Do not use supplemental engine oil additives because they are unnecessary and could lead to engine damage that may not be covered by your vehicle warranty.

**Note:** *Ford recommends using DOT 4 Low Viscosity (LV) High Performance Brake Fluid or equivalent meeting WSS-M6C65-A2. Use of any fluid other than the recommended fluid may cause degraded brake performance and not meet the Ford performance standards. Keep brake fluid clean and dry. Contamination with dirt, water, petroleum products or other materials may result in brake system damage and possible failure.*

**Note:** *Automatic transmissions that require MERCON LV transmission fluid should only use MERCON LV transmission fluid. The use of any other fluid may cause transmission damage.*

## Capacities and Specifications

| Item   | Capacity                                 |
|--|--|
| Engine oil (with oil filter)                       | 6.0 qt (5.7 L)                           |
| Engine coolant (without trailer tow)               | 13.1 qt (12.4 L)                         |
| Engine coolant (with trailer tow)                  | 13.4 qt (12.7 L)                         |
| Brake fluid  | Between MIN/MAX on brake fluid reservoir |
| Rear axle fluid (four-wheel drive)                 | 2.4 pt (1.15 L)                          |
| Automatic transmission fluid (6F50)                | 10.9 qt (10.3 L)*                        |
| Automatic transmission fluid (6F55)                | 11.6 qt (11 L)*                          |
| Power Transfer Unit (PTU) fluid (four-wheel drive) | 17.9 fl oz (0.53 L)                      |
| Windshield washer fluid                            | Fill as required                         |
| Fuel tank  | 18.6 gal (70.4 L)                        |
| A/C refrigerant (front wheel drive)                | 2.56 lb (1.16 kg)                        |
| A/C refrigerant (four-wheel drive)                 | 2.38 lb (1.08 kg)                        |
| A/C refrigerant compressor oil (front wheel drive) | 6.6 fl oz (195 ml)                       |
| A/C refrigerant compressor oil (four-wheel drive)  | 7.3 fl oz (215 ml)                       |

\*Approximate dry fill capacity. Actual amount may vary during fluid changes.

## Specifications

### Materials

| Name  | Specification |
|---|---------------|
| Recommended motor oil (U.S.):<br>Motorcraft® SAE 5W-20 Premium Synthetic Blend Motor Oil<br>XO-5W30-QSP | WSS-M2C945-A  |
| Recommended Motor oil (Canada):<br>Motorcraft® SAE 5W-20 Super Premium Motor Oil<br>CXO-5W30-LSPI2      | WSS-M2C945-A  |
| Recommended motor oil (Mexico):<br>Motorcraft® SAE 5W-20 Synthetic Motor Oil                            | WSS-M2C945-A  |

## Capacities and Specifications

| Name  | Specification             |
|---|---------------------------|
| MXO-5W30-QSP  |                           |
| Optional motor oil (U.S. and Mexico):<br>Motorcraft® SAE 5W-20 Full Synthetic Motor Oil<br>XO-5W30-QFS  | WSS-M2C945-A              |
| Optional Motor oil (Canada):<br>Motorcraft® SAE 5W-20 Synthetic Motor Oil<br>CXO-5W30-LFS12   | WSS-M2C945-A              |
| Engine coolant (U.S.):<br>Motorcraft® Orange Antifreeze/Coolant Prediluted<br>VC-3DIL-B   | WSS-M97B44-D2             |
| Engine coolant (Canada):<br>Motorcraft® Orange Antifreeze/Coolant Prediluted<br>CVC-3DIL-B  | WSS-M97B44-D2             |
| Engine coolant (Mexico):<br>Motorcraft® Antifreeze/Coolant Prediluted<br>VC-3DIL-B  | WSS-M97B44-D2             |
| Brake fluid:<br>Motorcraft® DOT 4 Low Viscosity (LV) High Performance<br>Motor Vehicle Brake Fluid<br>PM-20                                     | WSS-M6C65-A2              |
| Rear axle fluid (U.S. and Mexico)<br>Motorcraft® SAE 80W-90 Premium Rear Axle Lubricant<br>XY-80W90-QL  | WSP-M2C197-A              |
| Rear axle fluid (Canada)<br>Motorcraft® SAE 80W-90 Premium Rear Axle Lubricant<br>CXY-80W90-1L  | WSP-M2C197-A              |
| Automatic transmission fluid (U.S. and Mexico):<br>Motorcraft® MERCON LV Automatic Transmission Fluid<br>XT-10-QLVC                             | WSS-M2C938-A<br>MERCON LV |
| Automatic transmission fluid (Canada):<br>Motorcraft® MERCON LV Automatic Transmission Fluid<br>CXT-10-LV12                                     | WSS-M2C938-A<br>MERCON LV |
| Power Transfer Unit (PTU) fluid (All Wheel Drive) (U.S.<br>and Mexico)<br>Motorcraft® SAE 75W-140 Synthetic Rear Axle Lubricant<br>XY-75W140-QL | WSL-M2C192-A              |

## Capacities and Specifications

| Name   | Specification |
|--|---------------|
| Power Transfer Unit (PTU) fluid (All Wheel Drive) (Canada)<br>Motorcraft® SAE 75W-140 Synthetic Rear Axle Lubricant<br>CXY-75W140-1L | WSL-M2C192-A  |
| Windshield washer fluid (U.S. and Mexico):<br>Motorcraft® Premium Windshield Wash Concentrate with Bitterant<br>ZC-32-B2             | WSS-M14P19-A  |
| Windshield washer fluid (Canada):<br>Motorcraft® Premium Quality Windshield Washer Fluid<br>CXC-37-(A, B, D, F)                      | WSS-M14P19-A  |
| A/C refrigerant (U.S.):<br>Motorcraft® R-134a Refrigerant<br>YN-19   | WSH-M17B19-A  |
| A/C refrigerant (Canada):<br>Motorcraft® R-134a Refrigerant<br>CYN-16-R  | WSH-M17B19-A  |
| A/C refrigerant (Mexico):<br>Motorcraft® R-134a Refrigerant<br>MYN-19  | WSH-M17B19-A  |
| A/C refrigerant compressor oil:<br>Motorcraft® PAG Refrigerant Compressor Oil<br>YN-12-D   | WSH-M1C231-B  |
| Transmission, parking brake linkage and pivots and brake pedal shift grease:<br>Premium Long-Life Grease<br>XG-1-E1                  | ESA-M1C75-B   |
| Multi-purpose grease:<br>Motorcraft® Multi-Purpose Grease Spray<br>XL-5  | ESB-M1C93-B   |
| Lock cylinders (U.S.):<br>Penetrating and Lock Lubricant<br>XL-1   | --            |
| Lock cylinders (Canada):<br>Penetrating Fluid<br>CXC-51-A  | --            |
| Lock cylinders (Mexico):<br>Penetrating and Lock Lubricant   | --            |

# Capacities and Specifications

| Name  | Specification |
|-------|---------------|
| MXL-1 |               |

If you use oil and fluids that do not meet the defined specification and viscosity grade, this may lead to:

- Component damage which is not covered by the vehicle warranty.
- Longer engine cranking periods.
- Increased emission levels.
- Reduced engine performance.
- Reduced fuel economy.
- Degraded brake performance.

We recommend Motorcraft® motor oil for your vehicle. If Motorcraft® oil is not available, use motor oils of the recommended viscosity grade that meet API SN requirements and display the API Certification Mark for gasoline engines. Do not use oil labeled with API SN service category unless the label also displays the API certification mark.



E142732

An oil that displays this symbol conforms to current engine, emission system and fuel economy performance standards of the International Lubricants Specification Advisory Committee (ILSAC).

Do not use supplemental engine oil additives because they are unnecessary and could lead to engine damage that may not be covered by your vehicle warranty.

**Note:** *Ford recommends using DOT 4 Low Viscosity (LV) High Performance Brake Fluid or equivalent meeting WSS-M6C65-A2. Use of any fluid other than the recommended fluid may cause degraded brake performance and not meet the Ford performance standards. Keep brake fluid clean and dry. Contamination with dirt, water, petroleum products or other materials may result in brake system damage and possible failure.*

**Note:** *Automatic transmissions that require MERCON LV transmission fluid should only use MERCON LV transmission fluid. The use of any other fluid may cause transmission damage.*

# Capacities and Specifications

## CAPACITIES AND SPECIFICATIONS - 3.5L ECOBOOST™

### Capacities

#### WARNING



The air conditioning refrigerant system contains refrigerant under high pressure. Only qualified personnel should service the air conditioning refrigerant system. Opening the air conditioning refrigerant system can cause personal injury.

| Item   | Capacity                                 |
|--|--|
| Engine oil (with oil filter)                       | 6.0 qt (5.7 L)                           |
| Engine coolant                                     | 13.1 qt (12.4 L)                         |
| Brake fluid  | Between MIN/MAX on brake fluid reservoir |
| Rear axle fluid                                    | 2.4 pt (1.15 L)                          |
| Automatic transmission fluid (6F50)                | 10.9 qt (10.3 L) *                       |
| Automatic transmission fluid (6F55)                | 11.6 qt (11 L) *                         |
| Power Transfer Unit (PTU) fluid (four-wheel drive) | 17.9 fl oz (0.53 L)                      |
| Windshield washer fluid                            | Fill as required                         |
| Fuel tank  | 18.6 gal (70.4 L)                        |
| A/C refrigerant                                    | 2.8 lb (1.28 kg)                         |
| A/C refrigerant compressor oil                     | 7.3 fl oz (215 ml)                       |

\*Approximate dry fill capacity. Actual amount may vary during fluid changes.



# Capacities and Specifications

## Specifications

### Materials

| Name  | Specification |
|---|---------------|
| Recommended motor oil (U.S.):<br>Motorcraft® SAE 5W-30 Premium Synthetic Blend Motor Oil<br>XO-5W30-QSP     | WSS-M2C946-A  |
| Recommended Motor oil (Canada):<br>Motorcraft® SAE 5W-30 Super Premium Motor Oil<br>CXO-5W30-LSP12          | WSS-M2C946-A  |
| Recommended motor oil (Mexico):<br>Motorcraft® SAE 5W-30 Synthetic Motor Oil<br>MXO-5W30-QSP                | WSS-M2C946-A  |
| Optional motor oil (U.S. and Mexico):<br>Motorcraft® SAE 5W-30 Full Synthetic Motor Oil<br>XO-5W30-QFS      | WSS-M2C946-A  |
| Optional Motor oil (Canada):<br>Motorcraft® SAE 5W-30 Synthetic Motor Oil<br>CXO-5W30-LFS12                 | WSS-M2C946-A  |
| Engine coolant (U.S.):<br>Motorcraft® Orange Antifreeze/Coolant Prediluted<br>VC-3DIL-B                     | WSS-M97B44-D2 |
| Engine coolant (Canada):<br>Motorcraft® Orange Antifreeze/Coolant Prediluted<br>CVC-3DIL-B                  | WSS-M97B44-D2 |
| Engine coolant (Mexico):<br>Motorcraft® Antifreeze/Coolant Prediluted<br>VC-3DIL-B                          | WSS-M97B44-D2 |
| Brake fluid:<br>Motorcraft® DOT 4 Low Viscosity (LV) High Performance<br>Motor Vehicle Brake Fluid<br>PM-20 | WSS-M6C65-A2  |
| Rear axle fluid (U.S. and Mexico)<br>Motorcraft® SAE 80W-90 Premium Rear Axle Lubricant<br>XY-80W90-QL      | WSP-M2C197-A  |
| Rear axle fluid (Canada)<br>Motorcraft® SAE 80W-90 Premium Rear Axle Lubricant<br>CXY-80W90-1L              | WSP-M2C197-A  |

## Capacities and Specifications

| Name  | Specification             |
|---|---------------------------|
| Automatic transmission fluid (U.S. and Mexico):<br>Motorcraft® MERCON LV Automatic Transmission Fluid<br>XT-10-QLVC                           | WSS-M2C938-A<br>MERCON LV |
| Automatic transmission fluid (Canada):<br>Motorcraft® MERCON LV Automatic Transmission Fluid<br>CXT-10-LV12                                   | WSS-M2C938-A<br>MERCON LV |
| Power Transfer Unit (PTU) fluid (Four-wheel drive) (U.S. and Mexico)<br>Motorcraft® SAE 75W-140 Synthetic Rear Axle Lubricant<br>XY-75W140-QL | WSL-M2C192-A              |
| Power Transfer Unit (PTU) fluid (Four-wheel drive) (Canada)<br>Motorcraft® SAE 75W-140 Synthetic Rear Axle Lubricant<br>CXY-75W140-1L         | WSL-M2C192-A              |
| Windshield washer fluid (U.S. and Mexico):<br>Motorcraft® Premium Windshield Wash Concentrate<br>with Bitterant<br>ZC-32-B2                   | WSS-M14P19-A              |
| Windshield washer fluid (Canada):<br>Motorcraft® Premium Quality Windshield Washer Fluid<br>CXC-37-(A, B, D, F)                               | WSS-M14P19-A              |
| A/C refrigerant (U.S.):<br>Motorcraft® R-134a Refrigerant<br>YN-19  | WSH-M17B19-A              |
| A/C refrigerant (Canada):<br>Motorcraft® R-134a Refrigerant<br>CYN-16-R   | WSH-M17B19-A              |
| A/C refrigerant (Mexico):<br>Motorcraft® R-134a Refrigerant<br>MYN-19   | WSH-M17B19-A              |
| A/C refrigerant compressor oil:<br>Motorcraft® PAG Refrigerant Compressor Oil<br>YN-12-D  | WSH-M1C231-B              |
| Transmission, parking brake linkage and pivots and brake<br>pedal shift grease:<br>Premium Long-Life Grease<br>XG-1-E1                        | ESA-M1C75-B               |
| Multi-purpose grease:   | ESB-M1C93-B               |

## Capacities and Specifications

| Name  | Specification |
|---|---------------|
| Motorcraft® Multi-Purpose Grease Spray<br>XL-5                      |               |
| Lock cylinders (U.S.):<br>Penetrating and Lock Lubricant<br>XL-1    | --            |
| Lock cylinders (Canada):<br>Penetrating Fluid<br>CXC-51-A           | --            |
| Lock cylinders (Mexico):<br>Penetrating and Lock Lubricant<br>MXL-1 | --            |

If you use oil and fluids that do not meet the defined specification and viscosity grade, this may lead to:

- Component damage which is not covered by the vehicle warranty.
- Longer engine cranking periods.
- Increased emission levels.
- Reduced engine performance.
- Reduced fuel economy.
- Degraded brake performance.

We recommend Motorcraft® motor oil for your vehicle. If Motorcraft® oil is not available, use motor oils of the recommended viscosity grade that meet API SN requirements and display the API Certification Mark for gasoline engines. Do not use oil labeled with API SN service category unless the label also displays the API certification mark.



E142732

An oil that displays this symbol conforms to current engine, emission system and fuel economy performance standards of the International Lubricants Specification Advisory Committee (ILSAC).

Do not use supplemental engine oil additives because they are unnecessary and could lead to engine damage that may not be covered by your vehicle warranty.

## Capacities and Specifications

---

**Note:** *Ford recommends using DOT 4 Low Viscosity (LV) High Performance Brake Fluid or equivalent meeting WSS-M6C65-A2. Use of any fluid other than the recommended fluid may cause degraded brake performance and not meet the Ford performance standards. Keep brake fluid clean and dry. Contamination with dirt, water, petroleum products or other materials may result in brake system damage and possible failure.*

**Note:** *Automatic transmissions that require MERCON LV transmission fluid should only use MERCON LV transmission fluid. The use of any other fluid may cause transmission damage.*

# Audio System

## GENERAL INFORMATION

### Radio Frequencies and Reception Factors

AM and FM frequencies are established by the Federal Communications Commission (FCC) and the Canadian Radio and Telecommunications Commission (CRTC). Those frequencies are:

- AM: 530, 540-1700, 1710 kHz
- FM: 87.9-107.7, 107.9 MHz

| Radio Reception Factors      |   |
|------------------------------|---|
| <b>Distance and strength</b> | The further you travel from an AM or FM station, the weaker the signal and the weaker the reception.  |
| <b>Terrain</b>               | Hills, mountains, tall buildings, bridges, tunnels, freeway overpasses, parking garages, dense tree foliage and thunderstorms can interfere with the reception. |
| <b>Station overload</b>      | When you pass a ground-based broadcast repeating tower, a stronger signal may overtake a weaker one and result in the audio system muting.                      |

### CD and CD Player Information

**Note:** *CD units play commercially pressed 4.7 in (12 cm) audio compact discs only. Due to technical incompatibility, certain recordable and re-recordable compact discs may not function correctly when used in Ford CD players.*

**Note:** *Do not insert CDs with homemade paper (adhesive) labels into the CD player as the label may peel and cause the CD to become jammed. You should use a permanent felt tip marker rather than adhesive labels on your homemade CDs. Ballpoint pens may damage CDs. Please contact an authorized dealer for further information.*

**Note:** *Do not use any irregularly shaped discs or discs with a scratch protection film attached.*

Always handle discs by their edges only. Clean the disc with an approved CD cleaner only. Wipe it from the center of the disc toward the edge. Do not clean in a circular motion.

Do not expose discs to direct sunlight or heat sources for extended periods.

### MP3 and WMA Track and Folder Structure

Audio systems capable of recognizing and playing MP3 and WMA individual tracks and folder structures work as follows:

- There are two different modes for MP3 and WMA disc playback: MP3 and WMA track mode (system default) and MP3 and WMA folder mode.
- MP3 and WMA track mode ignores any folder structure on the MP3 and WMA disc. The player numbers each MP3 and WMA track on the disc (noted by the MP3 or WMA file extension) from T001 to a maximum of T255. The maximum number of playable MP3 and WMA files may be less depending on the structure of the CD and exact model of radio present.

# Audio System

---

- MP3 and WMA folder mode represents a folder structure consisting of one level of folders. The CD player numbers all MP3 and WMA tracks on the disc (noted by the MP3 or WMA file extension) and all folders containing MP3 and WMA files, from F001 (folder) T001 (track) to F253 T255.
- Creating discs with only one level of folders helps with navigation through the disc files.

If you are burning your own MP3 and WMA discs, it is important to understand how the system reads the structures you create. While various files may be present (files with extensions other than MP3 and WMA), only files with the MP3 and WMA extension are played; other files are ignored by the system. This enables you to use the same MP3 and WMA disc for a variety of tasks on your work computer, home computer and your in-vehicle system.

In track mode, the system displays and plays the structure as if it were only one level deep (all MP3 and WMA files play, regardless of being in a specific folder). In folder mode, the system only plays the MP3 and WMA files in the current folder.

## AUDIO UNIT - VEHICLES WITH: AM/FM/CD/SYNC

### WARNING



Driving while distracted can result in loss of vehicle control, crash and injury. We strongly recommend that you use extreme caution when using any device that may take your focus off the road. Your primary responsibility is the safe operation of your vehicle. We recommend against the use of any hand-held device while driving and encourage the use of voice-operated systems when possible. Make sure you are aware of all applicable local laws that may affect the use of electronic devices while driving.

**Note:** *You can operate your audio system for up to one hour after you switch off the ignition. Press the power control to operate the system with the ignition turned off. The system automatically turns off after one hour.*

# Audio System

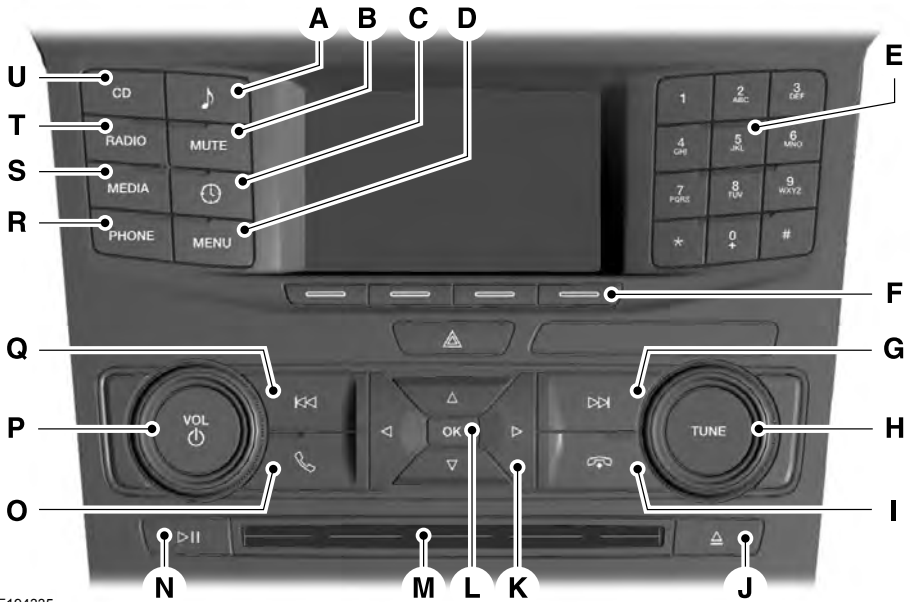

E194335

- A **SOUND:** Press to access settings for Treble, Midrange, Bass, Fade or Balance. Use the up and down arrow buttons to select the various settings. When you make your selection, press the left and right arrow buttons to change the settings. Press **OK** to set or press **MENU** to exit. Sound settings can be set for each audio source independently.
- B **MUTE:** Press to mute the playing audio.
- C **CLOCK:** If not in phone mode, press to display the clock.
- D **MENU:** Press to access different audio system features.
- E **Number block:** In radio mode, store and recall your favorite radio stations. To store a radio station, tune to the station, then press and hold a preset button until sound returns. In CD mode, select a track. In phone mode, enter a phone number.
- F **Function buttons:** Select different functions of the audio system depending on which mode you are in (such as Radio mode or CD mode).

# Audio System

---

- G **Seek and Fast Forward:** In radio mode, select a frequency band and press this button. The system stops at the first station up the band. Press and hold to move quickly, then release to stop at the next available station. In CD mode, press to select the next track. Press and hold to move quickly forward through the current track.
- H **TUNE:** In radio mode, turn to manually search through the radio frequency band.
- I **End phone call:** Press to end a phone call.
- J **Eject:** Press to eject a CD.
- K **Cursor arrows:** Press to scroll through the menu choices.
- L **OK:** Press to confirm menu selections.
- M **CD Slot:** Insert a CD.
- N **Play/Pause:** Press to either play or pause a track.
- O **Answer or make phone call:** Press to either answer or make a phone call.
- P **VOL and Power:** Press to switch the system on and off. Turn to adjust the volume.
- Q **Seek and Reverse:** In radio mode, select a frequency band and press this button. The system stops at the first station down the band. Press and hold to move quickly, then release to stop at the previous available station. In CD mode, press to select the previous track. Press and hold to move quickly backward through the current track.
- R **PHONE:** Press to access the phone features of the SYNC system. See your SYNC information.
- S **MEDIA:** Press to open the media source menu. You can press this multiple times to change to CD or to a SYNC-Media device or scroll through the media sources using the arrow buttons. Press OK to select a source.
- T **RADIO:** Press this multiple times to select a radio band. Press and hold to select the autostore function. Press to return to the main screen of the active radio band.
- U **CD:** Press to listen to a CD. Press the function buttons below the radio screen to select on-screen options of Repeat or Shuffle.



# Audio System

## AUDIO UNIT - VEHICLES WITH: PREMIUM AM/FM/CD

**Note:** *The touchscreen system controls most of the audio features. See your SYNC information.*

### WARNING



Driving while distracted can result in loss of vehicle control, crash and injury. We strongly recommend that you use extreme caution when using any device that may take your focus off the road. Your primary responsibility is the safe operation of your vehicle. We recommend against the use of any hand-held device while driving and encourage the use of voice-operated systems when possible. Make sure you are aware of all applicable local laws that may affect the use of electronic devices while driving.

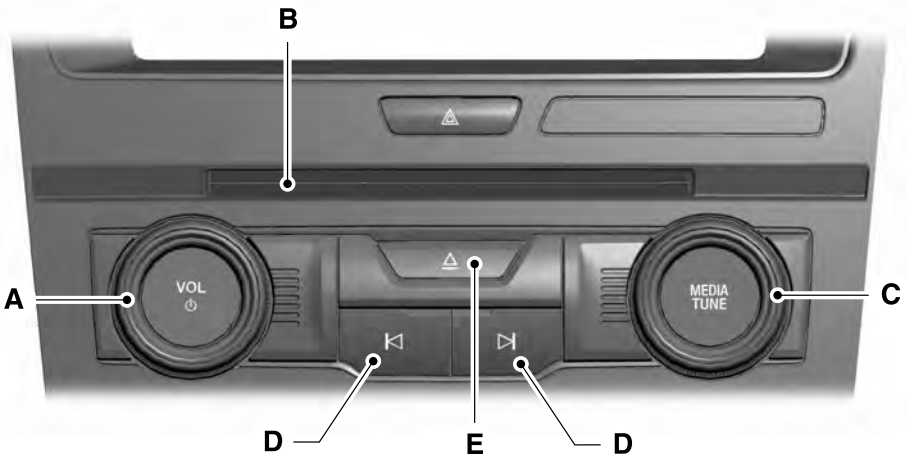

E194336

# Audio System

---

- A **VOL and Power:** Press to switch the system on and off. Turn to adjust the volume.
- B **CD slot:** Insert a CD.
- C **MEDIA and TUNE:** Press to access or switch between devices you plug into your vehicle. In radio mode, turn to manually search through the radio frequency band.
- D **Seek, Fast Forward and Reverse:** In radio mode, select a frequency band and press this button. The system stops at the first station it finds in that direction. In CD mode, press to select the previous or next track. Press and hold to move quickly forward through the current track.
- E **Eject:** Press to eject a CD.

**Note:** *The touchscreen controls most of the audio features. See your SYNC information.*

## AUDIO UNIT - VEHICLES WITH: SONY AM/FM/CD

### WARNING



Driving while distracted can result in loss of vehicle control, crash and injury. We strongly recommend that you use extreme caution when using any device that may take your focus off the road. Your primary responsibility is the safe operation of your vehicle. We recommend against the use of any hand-held device while driving and encourage the use of voice-operated systems when possible. Make sure you are aware of all applicable local laws that may affect the use of electronic devices while driving.

---

# Audio System

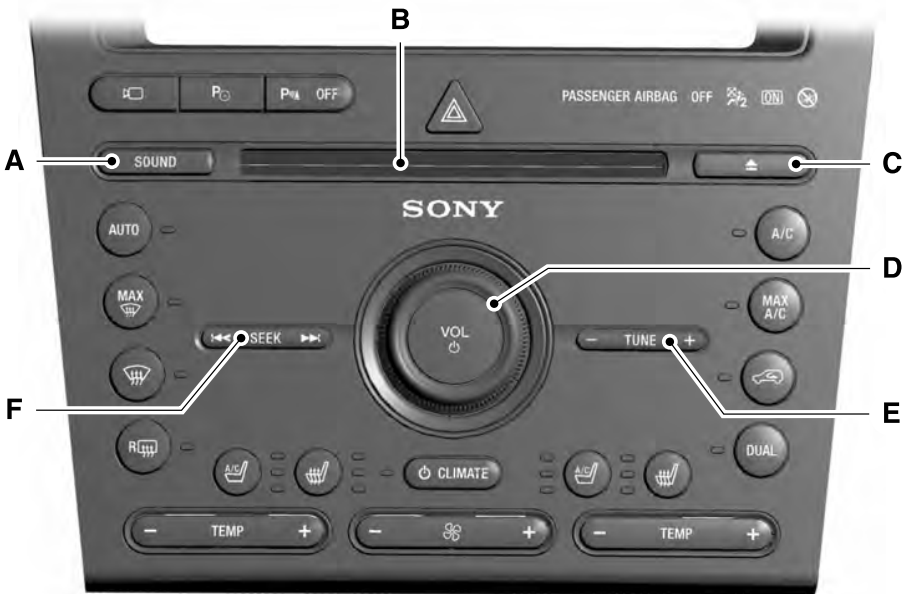

E194337

- A **SOUND:** Press to access settings for Treble, Midrange, Bass, Fade or Balance.
- B **CD slot:** Insert a CD.
- C **Eject:** Press to eject a CD.
- D **VOL and Power:** Press to switch the system off and on. Turn to adjust the volume.
- E **TUNE:** In radio mode, press to manually search through the radio frequency band. In SIRIUS mode, press to find the next or previous available satellite radio station.
- F **Seek, Reverse and Fast Forward:** In radio mode, select a frequency band and press either button. The system stops at the first station it finds in that direction. In SIRIUS mode, press to select the previous or next channel. If a specific category is selected (such as Jazz, Rock or News), use either button to find the previous or next channel in the selected category. In CD mode, press to select the previous or next track.

# Audio System

## Menu Structure

**Note:** Depending on your system, some options may appear slightly different.

Press **MENU**.

Press the up and down arrow buttons to scroll through the options.

Press the right arrow to enter a menu.  
Press the left arrow to exit a menu.

Press **OK** to confirm a selection.

| <b>Radio</b> |  |
|--------------|--|
| Manual tune  | Use the left and right arrows to go up or down the frequency band.   |
| Scan         | Select for a brief sampling of all available channels.   |
| AST          | Select to store the six strongest local stations on the AM-AST and FM-AST frequency bands.                                       |
| RBDS/RDS     | Select to view additional broadcast data, if available. This feature defaults to off. RBDS must be on for you to set a category. |

| <b>SIRIUS</b> |  |
|---------------|--|
| Scan          | Select for a brief sampling of all available channels.   |
| Show ESN      | Select to view your satellite radio electronic serial number (ESN). You will need this number when communicating with Sirius to activate, modify or track your account.  |
| Channel Guide | Select to view available satellite radio channels. Press <b>OK</b> to open a list of the following options for this channel: Tune Channel, Skip Channel or Lock Channel. Once you skip or lock a channel, you can only access it by pressing Direct and entering the channel number. Locking or unlocking a channel requires your PIN. |
| Set Category  | Select to view channel categories (such as Pop, Rock or News). If you select a category, seek and scan functions only stop on channels in that category.   |
| Alerts        | Select to turn off or turn on alerts for songs, artists or teams. The system alerts you when the selection is playing on another channel. Save up to 20 alerts.  |

# Audio System

## SIRIUS

|                     |  |
|---------------------|--|
| Unlock All Stations | Use your PIN to unlock previously locked stations.   |
| Skip No stations    | Use to restore any channels you previously skipped.  |
| Parental Lock (PIN) | Select to create a PIN, which allows you to lock or unlock channels. Your initial PIN is 1234. |

## Audio Settings

|                 |  |
|-----------------|--|
| Spd. Comp. Vol. | Automatically adjusts the volume to compensate for speed and wind noise. You can set the system between 0 and +7.                |
| Sound           | Select to adjust settings for Treble, Midrange, Bass, Fade and Balance.  |
| Occupancy Mode  | Select to optimize sound quality for the chosen seating position.  |
| RBDS/RDS        | Select to view additional broadcast data, if available. This feature defaults to off. RBDS must be on for you to set a category. |
| DSP             | Choose between STEREO SURROUND mode and STEREO mode.   |

## CD Settings

|                |  |
|----------------|--|
| Scan All       | Select to scan all disc selections.  |
| Scan Folder    | Select to scan all music in the current MP3 folder.                                    |
| CD Compression | Select to bring soft and loud passages together for a more consistent listening level. |

## Clock Settings

|          |  |
|----------|--|
| Set Time | Select to set the time.                                      |
| Set Date | Select to set the calendar date.                             |
| 24h Mode | Select to view clock time in a 12-hour mode or 24-hour mode. |

# Audio System

| Display Settings |   |
|------------------|---|
| Dimming          | Select to change display brightness.                                |
| Language         | Select to display the language in English, French or Spanish.       |
| Temp. setting    | Select to display the outside temperature in Fahrenheit or Celsius. |

## DIGITAL RADIO

**Note:** *HD Radio broadcasts are not available in all markets.*

HD Radio technology is the digital evolution of analog AM/FM radio. Your system has a special receiver that allows it to receive digital broadcasts (where available) in addition to the analog broadcasts, it already receives. Digital broadcasts provide a better sound quality than analog broadcasts with free, crystal-clear audio and no static or distortion. For more information, and a guide to available stations and programming, please visit [www.hdradio.com](http://www.hdradio.com).

When HD Radio is on and you tune to a station broadcasting HD Radio technology, you may notice the HD Radio logo on your screen. When this logo is available, you may also see Title and Artist fields on-screen.

The multicast indicator appears in FM mode (only) if the current station is broadcasting multiple digital broadcasts. The highlighted numbers signify available digital channels where new or different content is available. HD1 signifies the main programming status and is available in analog and digital broadcasts. Other multicast stations (HD2 through HD7) are only available digitally.

When HD Radio broadcasts are active, you can access the following functions:

- **Scan** allows you to hear a brief sampling of all available stations. This feature still works when HD Radio reception is on, although it does not scan for HD2-HD7 channels. You may see the HD logo appear if the station has a digital broadcast.
- **Memory presets** allow you to save an active channel as a memory preset. Touch and hold a memory preset slot until the sound returns. There is a brief mute while the radio saves the station. Sound returns when finished. When switching to an HD2 or HD3 memory preset, the sound mutes before the digital audio plays, because the system has to reacquire the digital signal.

**Note:** *As with any saved radio station, you cannot access the saved station if your vehicle is outside the station's reception area.*

# Audio System

## HD Radio Reception and Station Troubleshooting

| <b>Potential reception issues</b> |  |
|-----------------------------------|--|
| Reception area                    | If you are listening to a multicast station and you are on the fringe of the reception area, the station may mute due to weak signal strength.   |
|                                   | If you are listening to HD1, the system switches back to the analog broadcast until the digital broadcast is available again. However, if you are listening to any of the possible HD2-HD7 multicast channels, the station mutes and stays muted unless it is able to connect to the digital signal again.   |
| Station blending                  | When the system first receives a station (aside from HD2-HD7 multicast stations), it first plays the station in the analog version. Once the receiver verifies the station is an HD Radio station, it shifts to the digital version. Depending on the station quality, you may hear a slight sound change when the station changes from analog to digital. Blending is the shift from analog to digital sound or digital back to analog sound. |

In order to provide the best possible experience, use the contact form to report any station issues found while listening to a station broadcasting with HD Radio technology. Independent entities own and operate each station. These stations are responsible for ensuring all audio streams and data fields are accurate.

# Audio System

| Potential station issues   |   |   |
|--|---|---|
| Issues   | Cause   | Action  |
| Echo, stutter, skip or repeat in audio.<br>Increase or decrease in audio volume.                 | This is poor time alignment by the radio broadcaster.   | No action required. This is a broadcast issue.                                  |
| Sound fading or blending in and out.   | The radio is shifting between analog and digital audio.   | No action required. The reception issue may clear up as you continue to drive.  |
| There is an audio mute delay when selecting HD2 or HD3, multicast preset or <b>Direct Tune</b> . | The digital multicast is not available until the HD Radio broadcast is decoded. Once decoded, the audio is available. | No action required. This is normal behavior. Wait until the audio is available. |
| Cannot access HD2 or HD3 multicast channel when recalling a preset or from a direct tune.        | The previously stored multicast preset or direct tune is not available in your current reception area.                | No action required. The station is not available in your current location.      |
| Text information does not match currently playing audio.   | Data service issue by the radio broadcaster.  | Fill out the station issue form at website listed below.*                       |
| There is no text information shown for currently selected frequency.                             | Data service issue by the radio broadcaster.  | Fill out the station issue form at website listed below.*                       |
| HD2-HD7 stations not found when <b>Scan</b> is pressed.  | Pressing <b>Scan</b> disables HD2-HD7 channel search.   | No action required. This is normal behavior.                                    |

\* [http://www.ibiquity.com/automotive/report\\_radio\\_station\\_experiences](http://www.ibiquity.com/automotive/report_radio_station_experiences)

HD Radio Technology manufactured under license from iBiquity Digital Corp. U.S. and foreign patents. HD Radio and the HD and HD Radio logos are proprietary trademarks of iBiquity Digital Corp. Ford Motor Company and iBiquity Digital Corp. are not responsible for the content sent using HD Radio technology. Content may be changed, added or deleted at any time at the station owner's discretion.

## SATELLITE RADIO (If Equipped)

SIRIUS® broadcasts a variety of music, news, sports, weather, traffic and entertainment satellite radio channels. For more information and a complete list of SIRIUS satellite radio channels, visit [www.siriusxm.com](http://www.siriusxm.com) in the United States, [www.siriusxm.ca](http://www.siriusxm.ca) in Canada, or call SIRIUS at 1-888-539-7474.



# Audio System

**Note:** This receiver includes the eCos real-time operating system. eCos is published under the eCos License.

## Satellite Radio Reception Factors

| Potential satellite radio reception issues |  |
|--|--|
| Antenna obstructions                       | For optimal reception performance, keep the antenna clear of snow and ice build-up and keep luggage and other material as far away from the antenna as possible. |
| Terrain                                    | Hills, mountains, tall buildings, bridges, tunnels, freeway overpasses, parking garages, dense tree foliage and thunderstorms can interfere with your reception. |
| Station overload                           | When you pass a ground-based broadcast-repeating tower, a stronger signal may overtake a weaker one and the audio system may mute.                               |
| Satellite radio signal interference        | Your display may show ACQUIRING . . . to indicate the interference and the audio system may mute.  |

## SIRIUS® Satellite Radio Service

**Note:** SIRIUS reserves the unrestricted right to change, rearrange, add or delete programming including canceling, moving or adding particular channels, and its prices, at any time, with or without notice to you. Ford Motor Company shall not be responsible for any such programming changes.



E142593

SIRIUS satellite radio is a subscription-based satellite radio service that broadcasts a variety of music, sports, news, weather, traffic and entertainment programming. Your factory-installed SIRIUS satellite radio system includes hardware and a limited subscription term, which begins on the date of sale or lease of your vehicle. See an authorized dealer for availability.

For more information on extended subscription terms (a service fee is required), the online media player and a complete list of SIRIUS satellite radio channels, and other features, please visit [www.siriusxm.com](http://www.siriusxm.com) in the United States, [www.siriusxm.ca](http://www.siriusxm.ca) in Canada, or call SIRIUS at 1-888-539-7474.

## Satellite Radio Electronic Serial Number (ESN)

You need your ESN to activate, modify or track your satellite radio account. When in satellite radio mode, tune to channel 0.

# Audio System

## Troubleshooting

| Message  | Condition   | Action   |
|--|---|--|
| Acquiring...                                     | Radio requires more than two seconds to produce audio for the selected channel.       | No action required. This message should disappear shortly.   |
| Satellite antenna fault<br>SIRIUS system failure | There is an internal module or system failure present.                                | If this message does not clear shortly, or with an ignition key cycle, your receiver may have a fault. See an authorized dealer for service. |
| Invalid Channel                                  | The channel is no longer available.   | Tune to another channel or choose another preset.  |
| Unsubscribed Channel                             | Your subscription does not include this channel.                                      | Contact SIRIUS at 1-888-539-7474 to subscribe to the channel, or tune to another channel.  |
| No Signal  | The signal is lost from the SIRIUS satellite or SIRIUS tower to your vehicle antenna. | The signal is blocked. When you move into an open area, the signal should return.  |
| Updating...                                      | Update of channel programming in progress.  | No action required. The process may take up to three minutes.  |
| Questions? Call<br>1-888-539-7474                | Your satellite service is no longer available.  | Contact SIRIUS at 1-888-539-7474 to resolve subscription issues.   |
| None found<br>Check Channel Guide                | All the channels in the selected category are either skipped or locked.               | Use the channel guide to turn off the Lock or Skip function on that station.   |
| Subscription Updated                             | SIRIUS has updated the channels available for your vehicle.                           | No action required.  |

# Audio System

## USB PORT (If Equipped)

### WARNING



Driving while distracted can result in loss of vehicle control, crash and injury. We strongly recommend that you use extreme caution when using any device that may take your focus off the road. Your primary responsibility is the safe operation of your vehicle. We recommend against the use of any hand-held device while driving and encourage the use of voice-operated systems when possible. Make sure you are aware of all applicable local laws that may affect the use of electronic devices while driving.

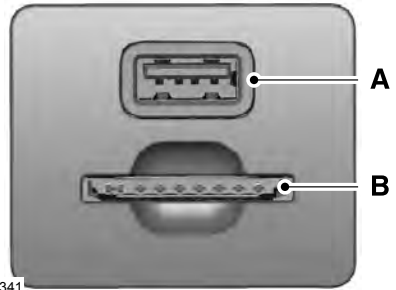

- A USB Port
- B SD card slot

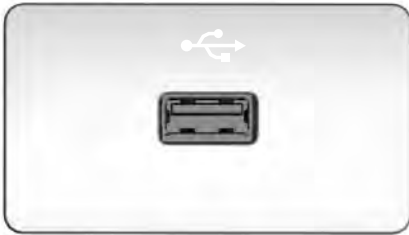

E201595

The USB port allows you to plug in media playing devices, memory sticks and charge devices (if supported). See **Using SYNC™ With Your Media Player** (page 387).

## MEDIA HUB (If Equipped)

The media hub is located in the center console or in front of the gear shift.

## GENERAL INFORMATION

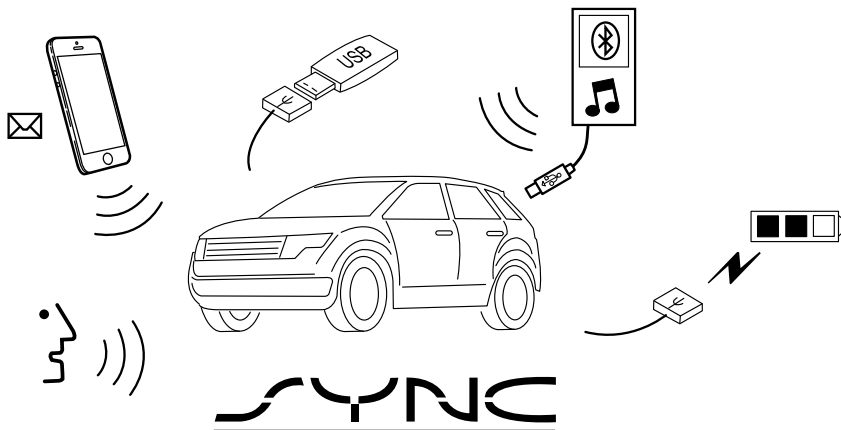

E198355

SYNC is an in-vehicle communications system that works with your Bluetooth-enabled cellular phone and portable media player. This allows you to:

- Make and receive calls.
- Access and play music from your portable music player.
- Use 911 Assist and applications, such as Spotify and Glympse, via SYNC AppLink.\*
- Access phonebook contacts and music using voice commands.
- Stream music from your connected phone.
- Text message.

- Use the advanced voice recognition system.
- Charge your USB device (if your device supports this).

\*These features are not available in all markets and may require activation. Available AppLink enabled apps vary by market.

Make sure that you review your device's manual before using it with SYNC.

### Support

The SYNC support team is available to help you with any questions you cannot answer on your own.

Monday-Saturday, 8:30am-9:00pm EST.

Sunday, 10:30am-7:30pm EST.

In the United States, call 1-800-392-3673.

In Canada, call 1-800-565-3673.

Times are subject to change due to holidays.

## SYNC Owner Account

Why do I need a SYNC owner account?

- Essential for keeping up with the latest software downloads available for SYNC.
- Access to customer support for any questions you may have.

## Driving Restrictions

For your safety, certain features are speed-dependent and restricted when your vehicle is traveling over 3 mi (5 km).

## Safety Information

### WARNING



Driving while distracted can result in loss of vehicle control, crash and injury. We strongly recommend that you use extreme caution when using any device that may take your focus off the road. Your primary responsibility is the safe operation of your vehicle. We recommend against the use of any hand-held device while driving and encourage the use of voice-operated systems when possible. Make sure you are aware of all applicable local laws that may affect the use of electronic devices while driving.

---

When using SYNC:

- Do not operate playing devices if the power cords or cables are broken, split or damaged. Place cords and cables out of the way, so they do not interfere with the operation of pedals, seats, compartments or safe driving abilities.
- Do not leave playing devices in your vehicle during extreme conditions as it could cause them damage. See your device's manual for further information.
- Do not attempt to service or repair the system. See an authorized dealer.

## Privacy Information

When a cellular phone is connected to SYNC, the system creates a profile within your vehicle that is linked to that cellular phone. This profile is created in order to offer you more cellular features and to operate more efficiently. Among other things, this profile may contain data about your cellular phone book, text messages (read and unread), and call history, including history of calls when your cellular phone was not connected to the system. In addition, if you connect a media device, the system creates and retains an index of supported media content. The system also records a short development log of approximately 10 minutes of all recent system activity. The log profile and other system data may be used to improve the system and help diagnose any problems that may occur.

The cellular profile, media device index, and development log will remain in the vehicle unless you delete them and are generally accessible only in the vehicle when the cellular phone or media player is connected. If you no longer plan to use the system or the vehicle, we recommend you perform a Master Reset to erase all stored information.

System data cannot be accessed without special equipment and access to the vehicle's SYNC module. Ford Motor Company and Ford of Canada will not access the system data for any purpose other than as described absent consent, a court order, or where required by law enforcement, other government authorities, or other third parties acting with lawful authority. Other parties may seek to access the information independently of Ford Motor Company and Ford of Canada. For further privacy information, see the section on 911 Assist. See **SYNC™ Applications and Services** (page 382).

## USING VOICE RECOGNITION

This system helps you control many features using voice commands. This allows you to keep your hands on the wheel and focus on what is around you.

### Initiating a Voice Session



Press the voice button. A list of available voice commands appears in the display.

### Global Voice Commands

These voice commands are always available. You can say them at any time.

| Global voice commands     |   |
|---------------------------|---|
| (cancel   exit)           | This command ends the voice session. You can also cancel a session by holding the voice button for two or more seconds. |
| help                      | This command provides you with hints, examples and instructions.  |
| (main menu   start again) | This command restarts the voice session from the initial starting point.  |

You can say any of the voice commands that appear within open and close brackets that are separated by |. For example, where; (cancel | exit) appears you say; cancel or exit.

### Helpful Hints

- Make sure the interior of your vehicle is as quiet as possible. Wind noise from open windows and road vibrations may prevent the system from correctly recognizing spoken commands.
- Before giving a voice command, wait for the system announcement to finish, followed by a single tone. Any command spoken before this does not register with the system.
- Speak naturally, without long pauses between words.
- You can interrupt the system at any time while it is speaking by pressing the voice button. You can cancel a voice session by pressing and holding the voice button.

## System Interaction and Feedback

The system provides feedback through audible tones, prompts, questions and spoken confirmations depending on the situation and the chosen level of interaction. You can customize the voice recognition system to provide more or less instruction and feedback.

The default setting is to a higher level of interaction in order to help you learn to use the system. You can change these settings at any time.

### Adjusting the Interaction Level



Press the voice button. When prompted, say:

| Voice Command                        | Action and Description   |
|--------------------------------------|--|
| voice settings                       |  |
| <b>Then either of the following:</b> |  |
| interaction mode novice              | Provides more detailed interaction and guidance. (Recommended for first time users.) |
| interaction mode advanced            | Provides less audible interaction and guidance.                                      |

## Confirmation Prompts

Confirmation prompts are short questions the system asks when it is not sure of your request or when there is more than one possible response to your request.

**To adjust this setting press the voice button, when prompted say:**

| Voice Command                        | Action and Description   |
|--------------------------------------|--|
| voice settings                       |  |
| <b>Then either of the following:</b> |  |
| confirmation prompts off             | Make a best guess from the command; you may still occasionally be asked to confirm settings. |
| confirmation prompts on              | Clarify your voice command with a short question.  |

## Phone Confirmation

Using phone confirmations the system asks you to verify before placing any calls.

**To adjust this setting press the voice button, when prompted say:**

| Voice Command                     | Action and Description   |
|-----------------------------------|--|
| voice settings                    |  |
| <b>Then any of the following:</b> |  |
| phone confirmation on             | When enabled, this feature will prompt you to confirm any voice initiated call command prior to the call being placed. |
| phone confirmation off            | The system will make a best guess; you may still occasionally be asked to confirm settings.                            |

## Changing the Voice Settings

In addition to using voice commands to change the voice settings, you can also use the menu in the audio display.

**To change the voice settings press the Menu button then select:**

| Menu Item      |
|----------------|
| SYNC-Settings  |
| Voice settings |

## USING SYNC™ WITH YOUR PHONE

Hands-free calling is one of the main features of SYNC. While the system supports a variety of features, many are dependent on your cellular phone's functionality. At a minimum, most cellular phones with Bluetooth wireless technology support the following functions:

- Answering an incoming call.
- Ending a call.
- Using privacy mode.
- Dialing a number.
- Redialing.

- Call waiting notification.
- Caller ID.

Other features, such as text messaging using Bluetooth and automatic phonebook download, are phone-dependent features. To check your phone's compatibility, see your phone's manual and visit [www.SYNCMYride.com](http://www.SYNCMYride.com), [www.SYNCMYride.ca](http://www.SYNCMYride.ca) or [www.syncmaroute.ca](http://www.syncmaroute.ca).

## Pairing a Phone for the First Time

Wirelessly pairing your phone with SYNC allows you to make and receive hands-free calls.

**Note:** SYNC can support downloading up to approximately 4000 entries per Bluetooth-enabled cellular phone.

**Note:** Make sure to switch on the ignition and the radio. Shift the transmission into park (P) for automatic transmission or first gear for manual transmission.

## Using the Audio System

**Note:** To scroll through the menus, press the up and down arrows on your audio system.



1. Make sure to switch on your phone's Bluetooth feature before starting the search. See your device's manual if necessary.
2. Press the **PHONE** button. When the audio display indicates there is no paired phone, select the option to add.
3. When a message to begin pairing appears in the audio display, search for SYNC on your phone to start the pairing process.
4. When prompted on your cell phone's display, confirm that the PIN provided by SYNC matches the PIN displayed on your cell phone. Your phone is now paired and the display indicates that the pairing was successful. If you are prompted to enter a PIN on your device, enter the PIN displayed on the screen. The display indicates when the pairing is successful.

Depending on your phone's capability and your market, the system may prompt you with questions, such as setting the current phone as the primary phone (the phone SYNC automatically tries to connect with first upon vehicle start-up) and downloading your phonebook.

## Using Voice Commands



Make sure to switch on your phone's Bluetooth feature before starting the search. See your device's manual if necessary.

## Press the voice and when prompted say:

| Voice Command   | Action and Description                        |
|---|---|
| (pair ([Bluetooth] device   phone   Bluetooth audio)   add phone) | Follow the instructions on the audio display. |

You can say any of the voice commands that appear within open and close brackets that are separated by |. For example, where; (what's | what is) appears you say; what's or what is.

The commands that have [ ] around the word means that the word is optional.

Depending on your phone's capability and your market, the system may prompt you with questions, such as setting the current phone as the primary phone (the phone SYNC automatically tries to connect with first upon vehicle start-up) and downloading your phonebook.

## Pairing Subsequent Phones

**Note:** Make sure to switch on the ignition and the radio. Shift the transmission into park (P) for automatic transmission or first gear for manual transmission.

**Note:** To scroll through the menus, press the up and down arrows on your audio system.

1. Make sure to switch on your phone's Bluetooth feature before starting the search. See your device's manual if necessary.
2. Press the **PHONE** button.
3. Select the option for Bluetooth Devices.
4. Press the **OK** button.

## SYNC™ (If Equipped)

- Select the option to add. This starts the pairing process.
- When a message to begin pairing appears in the audio display, search for SYNC on your device.
- When prompted on your cell phone's display, confirm that the PIN provided by SYNC matches the PIN displayed on your cell phone. Your phone is now paired and the display indicates that the pairing was successful. If you are prompted to enter a PIN on your device, enter the PIN displayed on the screen. The display indicates when the pairing is successful.

SYNC may prompt you with more cell phone options. Your cell phone may also prompt you to give SYNC permission to access information. For more information on your cell phone's capability, see your cell phone's manual and visit the website.

### Phone Voice Commands



Press the voice button. When prompted, say any of the following:

| Voice Command   |
|---|
| (phone   Blackberry   iPhone)                                   |
| <b>Then say any of the following:</b>                           |
| call (___)  |
| call ___ at home  |
| call ___ ((in at) [the] office   at work)                       |
| call ___ on (cell   mobile)                                     |
| call ___ on other   |
| dial [[a] number] <sup>1</sup>                                  |
| ([go to] privacy   transfer to phone   privacy on) <sup>2</sup> |

| Voice Command                                      |
|--|
| (hold call [on]   place call on hold) <sup>2</sup> |
| join (calls   call) <sup>2</sup>                   |
| mute call [on] <sup>2</sup>                        |
| (mute call off   un-mute call) <sup>2</sup>        |
| (turn ringer on   silent mode off)                 |
| (turn ringer off   silent mode [on])               |
| [text] (messages   message) <sup>3</sup>           |
| help   |

\_\_\_ is a dynamic listing that should be the name of a contact in your phonebook. For example you could say "Call Home".

<sup>1</sup> See **Dial** table below.

<sup>2</sup> These commands are only valid while in a phone call.

<sup>3</sup> See the text message table below.

### Dial Commands

Press the voice button and when prompted say any of the following commands:

| Voice Commands                              |
|---|
| 411 (four-one-one), 911 (nine-one-one)      |
| 700 (seven hundred)                         |
| 800 (eight hundred)                         |
| 900 (nine hundred)                          |
| Clear (deletes all entered digits)          |
| Delete (deletes last set of digits entered) |
| Number <0-9>                                |

| Voice Commands |
|----------------|
| Plus           |
| Pound (#)      |
| Star (*)       |

**Note:** To exit dial mode, press and hold the phone button or press any button on the audio system.

### To access text messages say:

| Voice Command                         |
|---------------------------------------|
| [text] (messages   message)           |
| <b>Then say any of the following:</b> |
| (listen to   read) ([text] message)   |
| forward (text   [text] message)       |
| reply to (text   [text] message)      |
| call [sender]                         |

### Phonebook Hints

To hear how the SYNC system speaks a name browse phonebook, select a contact and press:

| Menu Item |
|-----------|
| Hear it   |

### Changing Devices Using Voice Commands

Using SYNC, you can easily access multiple phones, ipods, or USB devices. to switch devices say:

| Voice Command           |   |
|-------------------------|---|
| (connect   device) ____ | You can state the name of the desired device, such as "My iPhone"; "My Galaxy" or "My iPod". SYNC may ask you to confirm the type of device (Phone, USB, or Bluetooth Audio). |

### Making Calls



**Press the voice button. When prompted, say:**

| Voice Command     |   |
|-------------------|---|
| call [[a] name]   |   |
| dial [[a] number] | SYNC prompts you to say the numbers that you wish to dial. After you say the numbers, the system confirms it. You can then say: |

**When the system has stated the number, you say any of the following:**

| Voice Command      |                                |
|--------------------|--------------------------------|
| (dial   send)      | This initiates the call.       |
| (delete   correct) | This erases the spoken digits. |

To end the call, press the end call button on the steering wheel or select the end call option in the audio display.

## Receiving Calls

### Accepting calls

When receiving a call, you can answer the call by pressing the accept call button on the steering wheel or use the screen.

### To use the screen to accept a call select:

| Menu Item |
|-----------|
| Accept    |

### Rejecting Calls

When receiving a call, you can reject the call by pressing the reject call button on the steering wheel or use the screen.

### To use the screen to reject a call select:

| Menu Item |
|-----------|
| Reject    |

Ignore the call by doing nothing.

### Phone Options during an Active Call

During an active call, you have more menu features that become available, such as putting a call on hold or joining calls.

To access this menu, choose one of the options available at the bottom of the audio display or select **More** to choose from the following options:

| Menu Item     | Description and action   |
|---------------|--|
| Mic. off      | Switch your vehicle's microphone off. To switch the microphone on, select the option again.  |
| Privacy       | Switch a call from an active hands-free environment to your cellular phone for a more private conversation. When selected, the audio display indicates the call is private.  |
| Hold          | Put an active call on hold. When selected, the audio display indicates the call is on hold.  |
| Dial a number | Enter numbers using the audio system's numeric keypad (for example, numbers for passwords).  |
| Join calls    | Join two separate calls. The system supports a maximum of three callers on a multiparty or conference call.<br>1. Select the <b>More</b> option.<br>2. Access the desired contact through the system or use voice commands to place the second call. Once actively in the second call, select the <b>More</b> option.<br>3. Scroll to the option to join calls and press the <b>OK</b> button. |
| Phonebook     | Access your phonebook contacts.<br>1. Select the <b>More</b> option.<br>2. Scroll to the option for phonebook and press the <b>OK</b> button.<br>3. Scroll through your phonebook contacts.  |

## SYNC™ (If Equipped)

| Menu Item    | Description and action   |
|--------------|--|
|              | <ol style="list-style-type: none"><li>4. Press the <b>OK</b> button again when the desired contact appears in the audio display.</li><li>5. Press the <b>OK</b> button or dial button to call the selection.</li></ol>   |
| Call History | <p>Access your call history log.</p> <ol style="list-style-type: none"><li>1. Select the <b>More</b> option.</li><li>2. Scroll to the option for call history and press the <b>OK</b> button.</li><li>3. Scroll through your call history options (incoming, outgoing or missed).</li><li>4. Press the <b>OK</b> button again when the desired selection appears in the audio display.</li><li>5. Press the <b>OK</b> button or dial button to call the selection.</li></ol> |

### Accessing Features through the Phone Menu

You can access your call history, phonebook, sent text messages, as well as access phone and system settings.

1. Press the **PHONE** button to enter the phone menu.
2. Select one of the options available.

| Display       | Description and action  |
|---------------|---|
| Dial a number | Enter numbers using the audio system's numeric keypad.  |
| Phonebook     | <p>Access your downloaded phonebook.</p> <ol style="list-style-type: none"><li>1. Press the <b>OK</b> button to confirm and enter. You can use the options at the bottom of the screen to access an alphabetical category quickly. You can also use the letters on the audio system's numeric keypad to jump in the list.</li><li>2. Scroll through your phonebook contacts.</li><li>3. Press the <b>OK</b> button again when the desired selection appears in the audio display.</li><li>4. Press the <b>OK</b> button or dial button to call the selection.</li></ol> |
| Call History  | <p>Access any previously dialed, received or missed calls.</p> <ol style="list-style-type: none"><li>1. Press the <b>OK</b> button to select.</li><li>2. Scroll to select incoming, outgoing or missed calls. Press the <b>OK</b> button to make your selection.</li><li>3. Press the <b>OK</b> button or dial button to call the selection.</li></ol>  |
| Speed Dial    | Select 1 of 10 speed dial entries. To set a speed dial entry, go to the phonebook and then press and hold one of the numbers on the audio system's numeric keypad.  |

## SYNC™ (If Equipped)

| Display        | Description and action  |
|----------------|---|
| Text messaging | Send, download and delete text messages.  |
| BT Devices     | Access the option for Bluetooth Device menu listings (add, connect, set as primary, on or off, delete). |
| Phone settings | View various settings and features on your phone.   |

### Text Messaging

**Note:** *This is a phone-dependent feature.*

SYNC allows you to receive, send, download and delete text messages. The system can also read incoming text messages to you so that you do not have to take your eyes off the road.

#### Receiving a Text Message

**Note:** *This is a phone-dependent feature. Your phone must support downloading text messages using Bluetooth to receive incoming text messages.*

**Note:** *This is a speed-dependent feature and is only available when your vehicle is traveling at 3.1 mph (5 km/h) or less.*

When a new message arrives, an audible tone sounds and the audio display indicates you have a new message.

#### To hear the message you can say:

| Voice command                       | Description and action   |
|-------------------------------------|--|
| (listen to   read) ([text] message) | Select this option to have the system read the message to you. |

### Using the screen you also have the following options:

| Menu Item | Description and action   |
|-----------|--|
| Ignore    | Select this option, or do nothing, and the message goes into your text message inbox.  |
| View      | Select the view option to open the text message. Once selected, you have the ability to have the message read to you, to view other messages. For additional options select: |
| More...   | If you select this option, use the arrow button to scroll through the following options:   |

| Menu Item | Description and action |   |
|-----------|------------------------|---|
|           | Reply to sender        | Press the <b>OK</b> button to access, and then scroll through a list of pre-defined messages to send.                                 |
|           | Call sender            | Press the <b>OK</b> button to call the sender of the message.   |
|           | Forward msg.           | Press the <b>OK</b> button to forward the message to anyone in your phonebook or call history. You can also choose to enter a number. |

## Sending, Downloading and Deleting Your Text Messages

1. Press the **PHONE** button.

2. Select the text messaging option, and then press the **OK** button.

### Choose from the following options:

| Menu Item | Description and action  |
|-----------|---|
| New       | Allows you to send a new text message based on a pre-defined set of 15 messages.  |
| View      | Allows you to read the full message and, in addition, provides the option to have the system read the message to you. To go to the next message, select the <b>More</b> option. This allows you to reply to the sender, call the sender or forward the message. |
| Delete    | Allows you to delete current text messages from the system (not your cellular phone). The audio display indicates when the system has deleted all your text messages.   |
| More...   | Allows you to delete all messages or manually trigger a download of all unread messages from your cellular phone.   |

## Sending a Text Message

**Note:** You can only send a text message to one recipient at a time.

1. Select the send option when the desired selection highlights in the audio display.
2. Select the confirmation option when the contact appears.

3. Press the OK button again to confirm when the system asks if you want to send the message. A pre-defined signature appears on each text message.

**Note:** You can send text messages either by choosing a contact from the phonebook and selecting the text option from the audio display or by replying to a received message in the inbox.

## Accessing Your Phone Settings

These are phone-dependent features. Your phone settings allow you to access and adjust features such as your ring tone and text message notification, modify your

phonebook, and set up automatic download.

1. Press the **PHONE** button.
2. Scroll until the phone settings option appears, and then press the **OK** button.

### Scroll to select from the following options:

| Menu Item       | Description and action  |
|-----------------|---|
| Set as master   | If this option is checked, the system uses the cellular phone as the master when there is more than one cellular phone paired to the system. This option can be changed for all cellular phones (not only the active phone) using the Bluetooth Devices menu.   |
| Phone status    | See the cellular phone name, provider name, cellular phone number, and signal level. When done, press the left arrow buttons to return to the phone status menu.  |
| Set ringtone    | Select which ringtone sounds during an incoming call (one of the system's tones or your cellular phone's). If your phone supports in-band ringing, your phone's ringtone sounds when you choose the cellular phone ringtone option.<br>1. Press the <b>OK</b> button to select and scroll to hear each ringtone.<br>2. Press the <b>OK</b> button to select a ringtone. |
| Text msg notify | Have the option of hearing an audible tone to notify you when a text message arrives. Press the <b>OK</b> button to switch the audible tone off or on.  |
| Phonebook pref. | Modify the contents of your phonebook (such as add, delete or download). Press the <b>OK</b> button to select and scroll between the choices in the phonebook preferences table below.  |



## SYNC™ (If Equipped)

| Menu Item       | Phonebook preferences  |                 |
|-----------------|--|-----------------|
| Add contacts    | Push the desired contacts on your cellular phone. See your device's manual on how to push contacts. Press the <b>OK</b> button to add more contacts from your phonebook.   |                 |
| Delete          | When a message asking you to delete appears, select the option to confirm. Press the <b>OK</b> button to delete the current phonebook and call history. The system takes you back to the menu for phone settings.  |                 |
| Download now    | Press the OK button to select and download your phonebook to the system.   |                 |
| Auto-download   | When automatic download is on, the system deletes any changes (additions or deletions) saved in the system since your last download.   |                 |
|                 | When automatic download is off, the system does not download your phonebook when your cellular phone connects to SYNC.   |                 |
|                 | You can only access your phonebook, call history and text messages when your paired cellular phone connects to the system. Check or uncheck this option to download your phonebook automatically each time your phone connects to the system. Download times are phone-dependent and quantity-dependent. |                 |
| Sorting Pref.   | Enabling this feature allows you to select how your contacts are displayed. You can select:  |                 |
|                 | <table border="1"> <tr> <td>First/Last name</td> <td>Last/First name</td> </tr> </table>   | First/Last name |
| First/Last name | Last/First name  |                 |

### Bluetooth Devices

The Bluetooth Devices menu allows you to add, connect and delete devices as well as set a phone as primary.

1. Press the **PHONE** button.
2. Scroll until Bluetooth Devices appears, and then press the **OK** button.

### Select from the following options:

| Menu Item | Description and action   |
|-----------|--|
| Add       | Pair additional phones to the system.<br>1. Select the option to add to start the pairing process. |

## SYNC™ (If Equipped)

| Menu Item | Description and action  |
|-----------|---|
|           | <p>2. When a message to begin pairing appears in the audio display, search for SYNC on your phone. See your phone's manual if necessary.</p> <p>3. When prompted on your cell phone's display, confirm that the PIN provided by SYNC matches the PIN displayed on your cell phone. Skip the next step. If you are prompted to enter a PIN on your device, it does not support Secure Simple Pairing. To pair, enter the PIN displayed on the screen. The display indicates when the pairing is successful.</p> <p>4. When the option to set the phone as primary appears, select either yes or no.</p> <p>5. SYNC may prompt you with more cell phone options. Your cell phone may also prompt you to give SYNC permission to access information. For more information on your cell phone's capability, see your cell phone's manual and visit the website.</p> |
| Delete    | <p>Select the delete option and confirm when the system asks to delete the selected device. After deleting a phone from the list, you have to repeat the pairing process to pair it again.</p>  |
| Master    | <p>The system attempts to connect with the primary cellular phone each time you switch on the ignition. When you select a cellular phone as primary, it appears first in the list, marked with an asterisk. Set a previously paired phone as master by selecting the master option and confirming it as the primary.</p>  |
| Conn.     | <p>Connect a previously connected phone. You can only have one phone connected at a time to use the phone's functionality. When you connect another phone, the previous phone disconnects from the telephone services. The system allows you to use different Bluetooth devices for the cellular phone functionality and the Bluetooth audio music playback feature at the same time.</p>   |
| Discon.   | <p>Disconnects the selected cellular phone. Select this option and confirm when asked. After disconnecting a phone, you can reconnect it again without repeating the full pairing process.</p>  |

### System Settings

1. Press the **MENU** button.

2. Select the SYNC settings option, and then press the **OK** button.

**Scroll to select from the following options:**

| <b>Display</b>  | <b>Description and action</b>   |
|-----------------|---|
| Bluetooth on    | Check or uncheck this option to switch the system's Bluetooth interface off or on. Select this option, and then press the <b>OK</b> button to change the option's status.   |
| Set defaults    | Return to the factory default settings without erasing your indexed information (such as phonebook, call history, text messages and paired devices). Select this option and confirm when prompted in the audio display.   |
| Master reset    | Completely erase all information stored in the system (such as phonebook, call history, text messages and paired devices) and return to factory default settings.   |
| Install on SYNC | Install downloaded applications or software updates. Select this option and confirm when prompted in the audio display. There must be a valid SYNC application or update available on the USB drive in order to finish an installation successfully.  |
| System info     | Display the system's version numbers as well as its serial number. Press the <b>OK</b> button to select.  |
| Voice settings  | The voice settings submenu contains various options. See <b>Using Voice Recognition</b> (page 368).   |
| Browse USB      | Browse the actual menu structure of the connected USB device. Press the <b>OK</b> button and use the up and down arrow buttons to scroll through the folders and files. Use the left or right arrow buttons to enter or leave a folder. You can select media content for playback from this menu. |

## SYNC™ APPLICATIONS AND SERVICES (If Equipped)

In order for the following features to work, your cellular phone must be compatible with SYNC. To check your phone's compatibility, visit [www.SYNCMYRide.com](http://www.SYNCMYRide.com), [www.SYNCMYRide.ca](http://www.SYNCMYRide.ca) or [www.syncmaroute.ca](http://www.syncmaroute.ca).

- 911 Assist: Can alert 911 in the event of an emergency.
- SYNC AppLink: Allows you to connect to and use certain applications such as Spotify and Glmpse (if your phone is compatible).

These features may require activation. Available AppLink enabled apps vary by market.

### 911 Assist

#### WARNINGS



Unless the 911 Assist setting is set on before a crash, the system will not dial for help which could delay response time, potentially increasing the risk of serious injury or death after a crash.



Do not wait for 911 Assist to make an emergency call if you can do it yourself. Dial emergency services immediately to avoid delayed response time which could increase the risk of serious injury or death after a crash. If you do not hear 911 Assist within five seconds of the crash, the system or phone may be damaged or non-functional.



Always place your phone in a secure location in your vehicle so it does not become a projectile or get damaged in a crash. Failure to do so may cause serious injury to someone or damage the phone which could prevent 911 Assist from working properly.

**Note:** The SYNC 911 Assist feature must be set on before the incident.

**Note:** The SYNC 911 Assist feature only operates in the U.S., Canada or in a territory in which 911 is the emergency number.

**Note:** Before setting this feature on, make sure that you read the 911 Assist Privacy Notice later in this section for important information.

**Note:** If any user switches 911 Assist to on or off, that setting applies for all paired phones. If 911 Assist is switched off, either a voice message plays or a display message or an icon comes on when your vehicle is started and after a previously paired phone connects.

**Note:** Every phone operates differently. While SYNC 911 Assist works with most cellular phones, some may have trouble using this feature.

If a crash deploys an airbag (excluding knee airbags and rear inflatable safety belts [if equipped]) or activates the fuel pump shut-off, your SYNC-equipped vehicle may be able to contact emergency services by dialing 911 through a paired and connected Bluetooth-enabled phone. You can learn more about the 911 Assist feature, visit [www.SYNCMYRide.com](http://www.SYNCMYRide.com), [www.SYNCMYRide.ca](http://www.SYNCMYRide.ca) or [www.syncmaroute.ca](http://www.syncmaroute.ca).

See **Supplementary Restraints System** (page 40). Important information about airbag deployment is in this chapter.

See **Roadside Emergencies** (page 251). Important information about the fuel pump shut-off is in this chapter.

## Setting 911 Assist On or Off

### Press Menu then select

| Menu Item         | Action and Description            |
|-------------------|-----------------------------------|
| SYNC-Applications |                                   |
| 911 Assist        | Select desired option, on or off. |

### If you choose not to activate this feature you will have the following options:

| Menu Item          | Action and Description   |
|--------------------|--|
| Voice Reminder ON  | Provides a display and voice reminder at phone connection at vehicle start.    |
| Voice Reminder OFF | Provides a display reminder only without a voice reminder at phone connection. |

To make sure that 911 Assist works properly:

- SYNC must be powered and working properly at the time of the incident and throughout feature activation and use.
- The 911 Assist feature must be set on before the incident.
- You must pair and connect a Bluetooth-enabled and compatible cell phone to SYNC.
- A connected Bluetooth-enabled phone must have the ability to make and maintain an outgoing call at the time of the incident.

- A connected Bluetooth-enabled phone must have adequate network coverage, battery power and signal strength.
- The vehicle must have battery power and be located in the U.S., Canada or in a territory in which 911 is the emergency number.

### In the Event of a Crash

Not all crashes deploy an airbag or activate the fuel pump shut-off (the triggers for 911 Assist). If a connected cell phone sustains damage or loses its connection to SYNC during a crash, SYNC searches for and tries to connect to a previously paired cell phone; SYNC then attempts to call the emergency services.

Before making the call:

- SYNC provides a short window of time (about 10 seconds) to cancel the call. If you fail to cancel the call, SYNC attempts to dial 911.
- SYNC says the following, or a similar message: "SYNC will attempt to call 911, to cancel the call, press Cancel on your screen or press and hold the phone button on your steering wheel".

If you do not cancel the call, and SYNC makes a successful call, a pre-recorded message plays for the 911 operator, and then the occupant(s) in your vehicle is able to talk with the operator. Be prepared to provide your name, phone number and location immediately, because not all 911 systems are capable of receiving this information electronically.

### 911 Assist May Not Work If

- Your cellular phone or 911 Assist hardware sustains damage in a crash.
- The vehicle's battery or the SYNC system has no power.
- The phone(s) thrown from your vehicle are the ones paired and connected to the system.

## 911 Assist Privacy Notice

When you switch on 911 Assist, it may disclose to emergency services that your vehicle has been in a crash involving the deployment of an airbag or activation of the fuel pump shut-off. Certain versions or updates to 911 Assist may also be capable of electronically or verbally disclosing to 911 operators your vehicle location or other details about your vehicle or crash to assist 911 operators to provide the most appropriate emergency services. If you do not want to disclose this information, do not switch the feature on.

## SYNC Mobile Apps

The system enables voice and steering wheel control of SYNC AppLink enabled smartphone apps. When an app is running through AppLink, you can control main features of the app through voice commands and steering wheel controls.

**Note:** You must pair and connect your smartphone to SYNC to access AppLink.

**Note:** iPhone users need to connect the phone to the USB port.

**Note:** Android users need to connect the phone to SYNC using Bluetooth.

**Note:** For information on available apps, supported smartphone devices and troubleshooting tips please visit the Ford website.

Availability of SYNC AppLink enabled Apps will vary by region.

**Note:** Make sure you have an active account for the app that you have downloaded. Some apps work automatically with no setup. Other apps want you to configure your personal settings and personalize your experience by creating stations or favorites. We recommend you do this at home or outside of your vehicle.

**Note:** AppLink is not available if your vehicle is equipped with the MyFordTouch system.

## To Access Using the SYNC Menu

**Press the MENU button to access the menu on-screen. Then select:**

| Menu Item   | Action and Description   |
|-------------|--|
| SYNC-Apps   |  |
| Mobile Apps | Scroll through the list of available applications and select a particular app or select: |
|             | Find New Apps  |

**Note:** If you cannot find a compatible SYNC AppLink app, make sure the required app is running on the mobile device.

## Accessing an App's Menu

When an app is running through SYNC, press the right arrow button on the steering wheel control to access the app menu.

You can access various app features from here, for example thumbs up and thumbs down.

Press the left arrow button on the steering wheel control to exit the app menu.

## To Access Using Voice Commands

**Press the voice button then when prompted say:**

| Menu Item                    | Action and Description   |
|------------------------------|--|
| mobile (apps   applications) | Say the name of the application after the tone. The app should start. When an app is running through SYNC, you can press the voice button and speak commands specific to the app, for example "Play Playlist Road Trip". |
| help                         | Use this command to discover the available voice commands.   |

## SYNC Mobile App Voice Commands

**The following voice commands are always available:**

| Menu Item   | Action and Description   |
|---|--|
| mobile (apps   applications)  | SYNC prompts you to say the name of an app to start it on SYNC.        |
| list [mobile] (apps   applications)   | SYNC lists all of the currently available mobile apps.                 |
| find [new] [mobile] (apps   applications)   | Searches your connected mobile device for SYNC-compatible mobile apps. |
| help  |  |
| You can say the name of a mobile app at any time to start the mobile app on SYNC. |  |

## App Permissions

App permissions are organized by groups. You can grant these group permissions individually. You can change a permission group status any time when not driving, by using the settings menu.

When you launch an app using SYNC, the system may ask you to grant certain permissions, for example:

- To allow your vehicle to provide vehicle information to the app such as, but not limited to: Fuel level, fuel economy, fuel consumption, engine speed, rain sensor, odometer, VIN, external temperature, gear position, tire pressure, and head lamp status.
- To allow your vehicle to provide driving characteristic information such as, but not limited to: MyKey, seat belt status, engine revolutions per minute, gear position, braking events, steering wheel angle, and accelerator pedal position.

## SYNC™ (If Equipped)

- To allow your vehicle to provide location information, including: GPS and speed.
- To allow the app to send push notifications using the vehicle display and voice capabilities while running in a background state. Push notifications may be particularly useful for news or

location based apps.

**Note:** *You only need to grant permissions the first time you use an app with SYNC.*

**Note:** *Ford is not responsible or liable for any damages or loss of privacy relating to usage of an app, or dissemination of any vehicle data that you approve Ford to provide to an app.*

### Enabling and Disabling App Permissions Using the SYNC Menu

**Press the MENU button to access the SYNC menu then select:**

| Menu Item   | Action and Description   |
|-------------|--|
| SYNC-Apps   |  |
| Mobile Apps |  |
| All Apps    | You can also select a specific app. If the app supports push notifications, this setting is listed. Select to enable or disable the feature as required. |

### Enabling SYNC Mobile Apps

In order to enable mobile apps, SYNC requires user consent to send and receive app authorization information and updates using the data plan associated with the connected device.

Data is sent to Ford in the United States through the connected device. The information is encrypted and includes your VIN, SYNC module number, anonymous usage statistics and debugging information. Updates may take place automatically.

**Note:** *You must enable mobile apps for each connected device the first time you select a mobile app using the system.*

**Note:** *Standard data rates apply. Ford is not responsible for any additional charges you may receive from your service provider, when your vehicle sends or receives data through the connected device. This includes any additional charges incurred due to driving in areas when roaming out of a home network.*

### App Status

You can view the current status of an app in the settings menu.



## SYNC™ (If Equipped)

### There are three possible statuses:

| Menu Item     | Action and Description   |
|---------------|--|
| Update Needed | The system has detected a new app requiring authorization or a general permissions update is required. |
| Up-To-Date    | No update is required.   |
| Updating...   | The system is trying to receive an update.   |

### Update settings

| Menu Item       | Action and Description   |
|-----------------|--|
| Request Update  | Select this option from the settings menu to manually preform a needed update.   |
| Disable Updates | Select this option from the settings menu to disable automatic updates. Doing so also disables the use of Mobile Apps on SYNC. |

## USING SYNC™ WITH YOUR MEDIA PLAYER

You can access and play music from your digital music player over your vehicle's speaker system using the system's media menu or voice commands. You can also sort and play your music by specific categories, such as artist and album.

**Note:** *The system is capable of indexing up to 15,000 songs.*

SYNC is capable of hosting nearly any digital media player including: iPod, Zune, plays from device players, and most USB drives. SYNC also supports audio formats, such as MP3, WMA, WAV and ACC.

Confirm that the USB device has been formatted correctly and has the following specifications:

- USB 2.0.
- File format must be FAT16/32.

The format of the audio files on the USB device must be:

- MP3.
- Non DRM protected WMA.
- WAV.
- AAC.

### Connecting Your Digital Media Player to the USB Port

**Note:** *If your digital media player has a power switch, make sure you switch it on before plugging it in.*

## To Connect Using Voice Commands

Plug the device into one of the vehicle's USB ports.

**Press the voice button and when prompted, say:**

| Voice Command                       | Action and Description  |
|-------------------------------------|---|
| (USB [stick]   iPod   MP3 [player]) | You can now play music by saying any of the appropriate voice commands. See the media voice commands. |

Words in brackets [ ] are optional and do not have to be spoken for the system to understand the command. For example, for where (USB [stick] | IPOD | MP3 [player]) appears, you can say USB or USB stick.

## To view USB content select:

| Message    | Description and Action  |
|------------|---|
| Browse USB | Depending on how many media files are on your connected device, an indexing message may appear in the display. When indexing is complete, the selected source starts to playback audio automatically. |

**You can browse the files on the USB device in categories. Select BROWSE from the buttons at the bottom of the audio display and choose from the following:**

| Message   |
|-----------|
| Play all  |
| Playlists |
| Songs     |
| Artists   |

## To Connect Using the System Menu

1. Plug the device into one of the vehicle's USB ports.
2. Press the **MEDIA** button and select either USB 1 or USB 2 from the media source list in the audio display.

| Message    |
|------------|
| Albums     |
| Genres     |
| Browse USB |
| Reset USB  |

## Media Voice Commands



Press the voice button and when prompted say:

## SYNC™ (If Equipped)

| Voice Command                       | Description and Action  |
|-------------------------------------|---|
| (USB [stick]   iPod   MP3 [player]) | You can now play music by saying any of the appropriate voice commands. |

You can say any of the voice commands that appear within open and close brackets that are separated by |. For example, where; (what's | what is) appears you say; what's or what is.

You must say any of the voice commands that appear outside of open and close brackets. For example, where; (what's | what is) playing, you must say either "what's playing" or "what is playing".

| Command  | Description and Action  |
|--|---|
| pause  | Pauses device playback.   |
| play   | Resumes device playback.  |
| play [album] ___   |   |
| play all   | Play all media on the device from the first track to the last.        |
| play [artist] ___  |   |
| play [genre] ___   |   |
| play [playlist] ___  |   |
| next [track   title   song   file   podcast   chapter   episode]     | Plays the next track   on the current media.                          |
| previous [track   title   song   file   podcast   chapter   episode] | Plays the previous track on current media.                            |
| [play] (similar music   more like this)                              | Creates a playlist with a similar genre to the one currently playing. |
| play [song   track   title   file] ___                               |   |
| repeat off   |   |
| repeat (one   track) [on]  | Repeats the current track.  |

## SYNCTM (If Equipped)

| Command   | Description and Action  |
|---|---|
| shuffle [all] [on]  | Plays the current playlist in a random order. (Not all devices support this command.)   |
| shuffle off   |   |
| ((who's   who is) this   who plays this   (what's   what is) playing [now]   (what   which) (song   track   artist) is this   (who's   who is) playing   (what's   what is) this) | At any time during playback, you can press the voice button and ask the system what is playing. The system reads the metadata tags (if populated) of the current track. |

\_\_\_ is a dynamic listing, meaning that it could be the name of anything, such as a group, artist or song. For example you could say "Play artist The Beatles".

### Examples of USB Commands

SYNC provides the user with many intuitive ways to find and play a song using voice. For example, if we have a song called "Penny Lane" from the album "Magical Mystery Tour" we can say the following to play this song:

- Play song "Penny Lane".
- Play "Penny Lane".

If we wanted to play the entire album, we can say:

- Play album "Magical Mystery Tour".
- Play "Magical Mystery Tour".

### Bluetooth Audio

The system is also capable of playing music from your cellular phone through Bluetooth.

To switch the Bluetooth audio on, use the **MEDIA** button (next to the audio display) or **Source** button, or press the voice button and when prompted say:

| Voice Command   |
|-----------------|
| Bluetooth audio |

Then any of the following:

| Voice Command  |
|--|
| pause  |
| play   |
| next [track   title   song   file   podcast   chapter   episode]     |
| previous [track   title   song   file   podcast   chapter   episode] |

## SYNC™ (If Equipped)

### Media Menu Features

The media menu allows you to select how to play your music (such as by artist, genre, shuffle or repeat), find similar music or

reset the index of your USB devices.

Press the **MEDIA** button and select either USB 1 or USB 2 from the media source list in the audio display to start USB playback.

| Message | Description and Action          |
|---------|---------------------------------|
| Options | This will enter the media menu. |

Then any of the following:

| Message       | Description and Action   |
|---------------|--|
| Shuffle       | Choose to shuffle or repeat your music. Once you make your choice, it remains on until you switch it off.  |
| Repeat track  | Choose to shuffle or repeat your music. Once you make your choice, it remains on until you switch it off.  |
| Similar music | You can play similar types of music to the current playlist from the USB port. The system uses the metadata information of each track to compile a playlist. The system then creates a new list of similar tracks and then begins playing. Each track must have the metadata tags populated for this feature. With certain playing devices, if your metadata tags are not populated, the tracks will not be available in voice recognition, the play menu or this option. However, if you place these tracks onto your playing device in mass storage device mode they are available in voice recognition, the play menu or this option. The system places unknowns into any unpopulated metadata tag. |
| Reset USB     | Resets the USB index. After the new indexing is complete you can choose what to play from the USB song library.  |

### Accessing Your USB Song Library

1. Plug the device into your vehicle's USB port.

2. Press the **MEDIA** button (next to the audio display) to select USB playback.

| Message    | Description and Action   |
|------------|--|
| Browse USB | This menu allows you to select and play your media files by artist, album, genre, playlist or track. |

## SYNC™ (If Equipped)

If there are no media files to access, the **NO MEDIA** display indicates there is no media.

### If there are media files, you have the following options:

| Display    | Description and Action  |
|------------|---|
| Play all   | Play all indexed media files from your device one at a time in numerical order.*<br>Press the <b>OK</b> button to select. The first track title appears in the display.   |
| Playlists  | Access your playlists (from formats like ASX, M3U, WPL, or MTP).*<br>1. Press the <b>OK</b> button to select.<br>2. Scroll to select the desired playlist, and then press the <b>OK</b> button.   |
| Songs      | Search for and play a specific indexed track.*<br>1. Press the <b>OK</b> button to select.<br>2. Scroll to select the desired track, and then press the <b>OK</b> button.   |
| Artists    | Sort all indexed media files by artist. The system then lists and plays all artists and tracks alphabetically.*<br>1. Press the <b>OK</b> button to select.<br>2. Scroll to select the desired artist, and then press the <b>OK</b> button. |
| Albums     | Sort all indexed media files by album.*<br>1. Press the <b>OK</b> button to select.<br>2. Scroll to select the desired album, and then press the <b>OK</b> button.  |
| Genres     | Sort all indexed media files by genre (category) type.*<br>1. Press the <b>OK</b> button to select.<br>2. Scroll to select the desired genre, and then press the <b>OK</b> button.  |
| Browse USB | Browse all supported media files on your media player connected to the USB port. You can only view media files that are compatible with SYNC. (Other files are not visible.)<br>1. Press the <b>OK</b> button to select.                    |

## SYNC™ (If Equipped)

| Display   | Description and Action   |
|-----------|--|
|           | 2. Scroll to browse indexed media files on the device, and then press the <b>OK</b> button.                      |
| Reset USB | Resets the USB index. After the new indexing is complete, you can choose what to play from the USB song library. |

\*You can use the buttons at the bottom of the audio display to jump to a certain alphabetical category quickly. You can also use the letters on the audio system's numeric keypad to jump in the list.

### Using Voice Commands

You can access and view your USB songs using voice commands.

Plug the device into your vehicle's USB port.

**Press the voice button and when prompted, say any of the following commands:**

| Accessing and Viewing USB Media  |
|--|
| (browse   search   show) all (album   albums)  |
| (browse   search   show) all (artist   artists)  |
| (browse   search   show) all (genre   genres)  |
| (browse   search   show) all (playlist   playlists)  |
| (browse   search   show) all (song   songs   title   titles   file   files   track   tracks) |
| (browse   search   show) album ____  |
| (browse   search   show) artist ____   |
| (browse   search   show) genre ____  |
| (browse   search   show) playlist ____   |

### USB 2 (If Equipped)

Your vehicle may come equipped with an additional USB port. If so, USB 1 is located at the front of the vehicle at the bottom of the instrument panel. USB 2 is located inside the storage compartment of the vehicle's center console.

You can plug in an additional USB device into the second USB port.

You can access both USB devices by using voice commands.

**To access a USB device press the voice button and when prompted say:**

| Voice command |
|---------------|
| USB 1         |
| USB 2         |

**Note:** SYNC only supports one connected iOS (Apple) devices at a time (whichever one you plug in first). When you connect a second iOS device, the systems charges it, but does not support playback from it.

### Bluetooth Devices and System Settings

You can access these menus using the audio display. See **Using SYNC™ With Your Phone** (page 370).

## Voice Commands for Audio Sources

Your voice system allows you to change audio sources with a simple voice command.



**Press the voice button and when prompted say:**

| Voice Command  |
|--|
| (music   audio   entertainment) [system]                       |
| <b>Below are a few examples of voice commands you can use.</b> |
| [tune [to]] AM   |
| [tune [to]] AM1  |
| [tune [to]] AM (autostore   AST   autoset)                     |
| [tune [to]] AM 2   |
| Bluetooth (audio   stereo)                                     |
| (disc   CD [player]) play                                      |
| [tune [to]] FM   |
| [tune [to]] FM1  |
| [tune [to]] FM (autostore   AST   autoset)                     |
| [tune [to]] FM 2   |
| Radio  |
| tune [to] SAT *  |
| Sirius *   |
| (USB [stick]   iPod   MP3 [player])                            |

### Voice Command

((who's | who is) this | who plays this | (what's | what is) playing [now] | (what | which) (song | track | artist) is this | (who's | who is) playing | (what's | what is) this)

help

\* If equipped.

## Radio Voice Commands



If you are listening to the radio, press the voice button, and then say any of the commands in the following table.

**If you are not listening to the radio, press the voice button and, after the tone, say:**

| Voice Command  |
|--|
| Radio  |
| <b>You can then say any of the following commands.</b> |
| [tune [to]] AM   |
| [tune [to]] AM1  |
| [tune [to]] AM (autostore   AST   autoset)             |
| [tune [to]] AM 2                                       |
| [tune [to]] (AM ___   ___ [AM])                        |
| [tune [to]] AM preset ___                              |
| [tune [to]] AM1 preset ___                             |
| [tune [to]] FM   |
| [tune [to]] FM1  |
| [tune [to]] FM (autostore   AST   autoset) preset ___  |



# SYNC™ (If Equipped)

| Voice Command                   |
|---------------------------------|
| [tune [to]] FM 2                |
| [tune [to]] (FM ___   ___ [FM]) |
| [tune [to]] FM preset ___       |
| FM ___ HD ___ *                 |
| [tune [to]] FM 2 preset ___     |
| HD ___ *                        |
| [tune [to]] preset ___          |
| Tune                            |
| help                            |

\* If equipped.

## Sirius Satellite Radio Voice Commands (If equipped)



To listen to Sirius satellite radio, press the voice button and, after the tone, say:

| Voice Commands |
|----------------|
| Sirius         |

**When you are listening to Sirius satellite radio, you can press the voice button, and say any of the commands in the following table.**

| Voice Commands               |
|------------------------------|
| tune [to] SAT                |
| [tune [to]] SAT 1            |
| [tune [to]] SAT 2            |
| [tune [to]] SAT 3            |
| [tune [to]] preset ___       |
| [tune [to]] SAT 1 preset ___ |

| Voice Commands                   |  |
|----------------------------------|--|
| [tune [to]] SAT 2 preset ___     |  |
| [tune [to]] SAT 3 preset ___     |  |
| tune [to] [Sirius]               |  |
| Help                             |  |
| [tune [to]] Sirius [channel] ___ | You can say the channel number (0-233) to listen to that Sirius station. |

## CD Voice Commands



If you are listening to a CD, press the voice button, and then say any of the commands in the following table.

**If you are not listening to a CD, press the voice button and, after the tone, say:**

| Voice Command  |
|--|
| (disc   CD [player]) play                              |
| <b>You can then say any of the following commands.</b> |
| pause  |
| play   |
| [play] next track                                      |
| [play] previous track                                  |
| [play   change to] track [number] ___                  |
| repeat (track   song) [on]                             |
| repeat folder [on]                                     |
| repeat off   |
| (shuffle   random   mix) [on   (tracks   songs) [on]]  |

## SYNC™ (If Equipped)

| Voice Command                                      |
|--|
| (shuffle   random   mix) (CD [player]   disc) [on] |
| (shuffle   random   mix) folder [on]               |
| shuffle off  |

Use the website at any time to check your phone's compatibility, register your account and set preferences as well as access a customer representative via an online chat (during certain hours). Visit [www.SYNCMyRide.com](http://www.SYNCMyRide.com), [www.SYNCMyRide.ca](http://www.SYNCMyRide.ca) or [www.syncmaroute.ca](http://www.syncmaroute.ca) for more information.

## SYNC™ TROUBLESHOOTING

Your SYNC system is easy to use. However, should questions arise, see the tables below.

| Phone issues   |   |   |
|--|---|---|
| Issue  | Possible cause(s)   | Possible solution(s)  |
| There is excessive background noise during a phone call.                                     | The audio control settings on your phone may be affecting SYNC performance.         | Review your phone's manual about audio adjustments.   |
| During a call, I can hear the other person but they cannot hear me.                          | This may be a possible phone malfunction.   | Try turning off the device, resetting the device, removing the device's battery, then trying again.   |
| SYNC is not able to download my phonebook.   | This is a phone-dependent feature.<br><br>This may be a possible phone malfunction. | Go to the website to review your phone's compatibility.<br><br>Try turning off the device, resetting the device or removing the device's battery, then trying again.<br><br>Try pushing your phonebook contacts to SYNC by using the Add Contacts feature.<br><br>Use the SYNCmyphone feature available on the website. |
| The system says Phonebook Downloaded but the phonebook in SYNC is empty or missing contacts. | This may be a limitation on your phone's capability.                                | Try pushing your phonebook contacts to SYNC by using the Add Contacts feature.  |



## SYNC™ (If Equipped)

| <b>Phone issues</b>                    |  |   |
|--|--|---|
| <b>Issue</b>                           | <b>Possible cause(s)</b>   | <b>Possible solution(s)</b>   |
|  |  | Turn off the Auto phone-book download setting.  |
| Text messaging is not working on SYNC. | <p>This is a phone-dependent feature.</p> <p>This may be a possible phone malfunction.</p> | <p>Go to the website to review your phone's compatibility.</p> <p>Try turning off the device, resetting the device or removing the device's battery, then trying again.</p> |

| <b>USB and media issues</b>                               |  |   |
|---|--|---|
| <b>Issue</b>  | <b>Possible cause(s)</b>                   | <b>Possible solution(s)</b>   |
| I am having trouble connecting my device.                 | This may be a possible device malfunction. | <p>Try turning off the device, resetting the device, removing the device's battery, then trying again.</p> <p>Make sure you are using the manufacturer's cable.</p> <p>Make sure you insert the USB cable correctly into the device and the USB port.</p> <p>Make sure that the device does not have an auto-install program or active security settings.</p> |
| SYNC does not recognize my device when I turn on the car. | This is a device limitation.               | Make sure you are not leaving the device in your vehicle during very hot or cold temperatures.  |
| Bluetooth audio does not stream.                          | This is a phone-dependent feature.         | Review the device compatibility chart on the SYNC website to confirm your phone supports the Bluetooth audio streaming function.  |

## SYNC™ (If Equipped)

| <b>USB and media issues</b>                         |  |  |
|---|--|--|
| <b>Issue</b>  | <b>Possible cause(s)</b>   | <b>Possible solution(s)</b>  |
|   | The device is not connected.   | Make sure you correctly connect the device to SYNC, and that you have pressed play on your device.   |
| SYNC does not recognize music that is on my device. | <p>Your music files may not contain the correct artist, song title, album or genre information.</p> <p>The file may be corrupted.</p> <p>The song may have copy-right protection, which does not allow it to play.</p> | <p>Make sure that all song details are populated.</p> <p>Some devices require you to change the USB settings from mass storage to MTP class.</p> |

| <b>Voice command issues</b>                            |   |  |
|--|---|--|
| <b>Issue</b>   | <b>Possible cause(s)</b>  | <b>Possible solution(s)</b>  |
| SYNC does not understand what I am saying.             | <p>You may be using the wrong voice commands.</p> <p>You may be speaking too soon or at the wrong time.</p> | <p>Review the phone voice commands and the media voice commands at the beginning of their respective sections.</p> <p>After pressing the voice icon, wait until after the tone sounds and Listening appears before saying a command. Any command spoken before this does not register with the system.</p> |
| SYNC does not understand the name of a song or artist. | You may be using the wrong voice commands.  | Review the media voice commands at the beginning of the media section.   |

## SYNC™ (If Equipped)

| <b>Voice command issues</b>   |  |  |
|---|--|--|
| <b>Issue</b>  | <b>Possible cause(s)</b>   | <b>Possible solution(s)</b>  |
|   | <p>You may be saying the name differently than the way you saved it.</p> <p>The system may not be reading the name the same way you are saying it.</p> | <p>Say the song or artist exactly as listed. If you say "Play Artist Prince", the system does not play music by Prince and the Revolution or Prince and the New Power Generation.</p> <p>Make sure you are saying the complete title, such as "California remix featuring Jennifer Nettles".</p> <p>If the song titles are in all CAPS, you have to spell them. LOLA requires you to say "L-O-L-A".</p> <p>Do not use special characters in the title. The system does not recognize them.</p> |
| <p>SYNC does not understand or is calling the wrong contact when I want to make a call.</p> | <p>You may be using the wrong voice commands.</p> <p>You may be saying the name differently than the way you saved it.</p>                             | <p>Review the Phone voice commands at the beginning of the phone section.</p> <p>Make sure you are saying the contacts exactly as they are listed. For example, if you save a contact as Joe Wilson, say "Call Joe Wilson".</p> <p>Using the SYNC phone menu, open the phonebook and scroll to the name SYNC is having trouble understanding. SYNC will read the name to you, giving you some idea of the pronunciation SYNC is expecting.</p>   |

## SYNC™ (If Equipped)

| <b>Voice command issues</b> |   |  |
|-----------------------------|---|--|
| <b>Issue</b>                | <b>Possible cause(s)</b>  | <b>Possible solution(s)</b>  |
|                             | <p>The system may not be reading the name the same way you are saying it.</p> <p>Contacts in your phonebook may be very short and similar, or they may contain special characters.</p> <p>Your phonebook contacts may be in CAPS.</p> | <p>The system works better if you list full names, such as "Joe Wilson" rather than "Joe".</p> <p>Do not use special characters, such as 123 or ICE, as the system does not recognize them.</p> <p>If a contact is in CAPS, you have to spell it. JAKE requires you to say "Call J-A-K-E".</p> |

| <b>AppLink issues</b>   |  |   |
|---|--|---|
| <b>Issue</b>  | <b>Possible cause(s)</b>   | <b>Possible solution(s)</b>   |
| <p>AppLink Mobile Applications: When I select "Find New Apps," SYNC does not find any applications.</p> | <p>An AppLink capable phone is not connected to SYNC.</p>                        | <p>Ensure you have a compatible smartphone; an Android with OS 2.3 or higher or an iPhone 3GS or newer with iOS 5.0 or higher. Additionally, ensure your phone is paired and connected to SYNC in order to find AppLink-capable apps on your device. iPhone users must also connect to SYNC's USB port with an Apple USB cable.</p> |
| <p>My phone is connected, but I still cannot find any apps.</p>   | <p>AppLink-enabled apps are not installed and running on your mobile device.</p> | <p>Ensure you have downloaded and installed the latest version of the app from your phone's app store. Ensure the app is running on your phone. Some apps require you to register or</p>  |

## SYNC™ (If Equipped)

| <b>AppLink issues</b>   |  |   |
|---|--|---|
| <b>Issue</b>  | <b>Possible cause(s)</b>   | <b>Possible solution(s)</b>   |
|   |  | login on the app on the phone before using them with AppLink. Also, some may have a "Ford SYNC" setting, so check the app's settings menu on the phone.   |
| My phone is connected, my app(s) are running, but I still cannot find any apps.                           | Sometime apps do not properly close and re-open their connection to SYNC, over ignition cycles, for example.   | <p>Closing and restarting apps may help SYNC find the application if you cannot discover it inside the vehicle.</p> <p>On an Android device, if apps have an "Exit" or 'Quit' option, select that then restart the app. If the app does not have that option, you can also manually "Force Close" the app by going to the phone's settings menu, selecting 'Apps.' then finding the particular app and choosing 'Force stop.' Don't forget to restart the app afterwards, then select "Find New Apps" on SYNC.</p> <p>On an iPhone with iOS7+, to force close an app, double tap the home button then swipe up on the app to close it. Tab the home button again, then select the app again to restart it. After a few seconds, the app should then appear in SYNC's Mobile App's Menu.</p> |
| My Android phone is connected, my app(s) are running, I restarted them, but I still cannot find any apps. | There is a Bluetooth bug on some order versions of the Android operating system that may cause apps that were found on your previous vehicle drive to not be found again if you have not turned off Bluetooth. | Reset the Bluetooth on your phone by turning it off and then turning Bluetooth back on. If you are in your vehicle, SYNC should be able to automatically re-connect to your phone if you press the "Phone" button.  |



## SYNC™ (If Equipped)

| <b>AppLink issues</b>  |   |   |
|--|---|---|
| <b>Issue</b>   | <b>Possible cause(s)</b>  | <b>Possible solution(s)</b>   |
| My iPhone phone is connected, my app is running, I restarted the app but I still cannot find it on SYNC.           | The USB connection to SYNC may need to be reset.  | Unplug the USB cable from the phone, wait a moment, and plug the USB cable back in to the phone. After a few seconds, the app should appear in SYNC's Mobile Apps Menu. If not, "Force Close" the application and restart it. |
| I have an Android phone. I found and started my media app on SYNC, but there is no sound or the sound is very low. | The bluetooth volume on the phone may be low.   | Try increasing the Bluetooth volume of the device by using the device's volume control buttons which are most often found on the side of the device.  |
| I can only see some of the AppLink apps running on my phone listed in SYNC's Mobile Apps Menu.                     | Some Android devices have a limited number of bluetooth ports apps can use to connect. If you have more AppLink apps on your phone than the number of available Bluetooth ports, you will not see all of your apps listed in SYNC's mobile apps menu. | Force close or uninstall the apps you do not want SYNC to find. If the app has a "Ford SYNC" setting, disable that setting in the app's settings menu on the phone.   |

| <b>SYNC System Reset</b>   |
|--|
| The SYNC system in your vehicle has System Reset feature that can be performed if the function of a SYNC feature is lost. This reset is intended to restore functionality and will not erase any information previously stored in the system (Such as paired devices, phonebook, call history, text messages, or user settings). To perform a System Reset, press and hold the Seek Up (>>) button while pressing and holding the Radio Power button. Release both buttons after 2-3 seconds. Please allow a few minutes for the reset to complete. After a few minutes has passed you can resume using the SYNC system. |

# MyFord Touch™ (If Equipped)

## GENERAL INFORMATION

## WARNING



Driving while distracted can result in loss of vehicle control, crash and injury. We strongly recommend that you use extreme caution when using any device that may take your focus off the road. Your primary responsibility is the safe operation of your vehicle. We recommend against the use of any hand-held device while driving and encourage the use of voice-operated systems when possible. Make sure you are aware of all applicable local laws that may affect the use of electronic devices while driving.

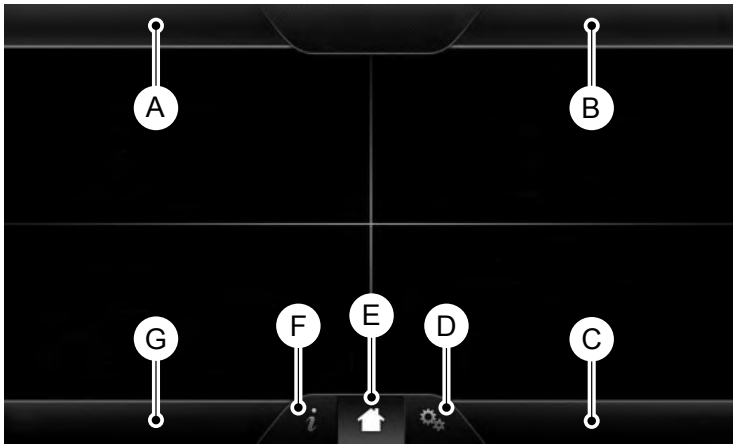

E161891

| Item | Message    |
|------|------------|
| A    | Phone      |
| B    | Navigation |
| C    | Climate    |
| D    | Settings   |

| Item | Message       |
|------|---------------|
| E    | Home          |
| F    | Information   |
| G    | Entertainment |

# MyFord Touch™ (If Equipped)

This system uses a four-corner strategy to provide quick access to several vehicle features and settings. The touchscreen provides easy interaction with your cell phone, entertainment, information and system settings. The corners display active modes within the menus, for example; your cell phone's status.

**Note:** *Some features are not available while your vehicle is moving.*

**Note:** *You can access the entertainment features for 30 minutes after you switch the ignition off, and no doors are opened.*

## PHONE

**Press to select any of the following:**

| Message    |
|------------|
| Phone      |
| Quick Dial |
| Phonebook  |
| History    |
| Messaging  |
| Settings   |

## NAVIGATION

**Press to select any of the following:**

| Message               |
|-----------------------|
| My Home               |
| Favorites             |
| Previous Destinations |
| Point of Interest     |
| Emergency             |
| Street Address        |
| Intersection          |

| Message      |
|--------------|
| City Center  |
| Map          |
| Edit Route   |
| Cancel Route |

## CLIMATE

Press the corresponding icons to control the following options:

- Driver Settings
- Recirculated Air
- Auto
- Dual
- Passenger Settings
- A/C
- Defrost

## SETTINGS



**Press to select any of the following:**

| Message  |
|----------|
| Clock    |
| Display  |
| Sound    |
| Vehicle  |
| Settings |
| Help     |

## HOME



Press to access the home screen.

# MyFord Touch™ (If Equipped)

**Note:** Depending on your vehicle's option package and software, the screens may vary in appearance from the descriptions in this section. The features may also be limited depending on the market. Check with an authorized dealer for availability.

## INFORMATION



**Press to select any of the following:**

| Message     |
|-------------|
| Services    |
| Travel Link |
| Alerts      |

| Message     |
|-------------|
| Calendar    |
| Apps        |
| Where Am I? |

## ENTERTAINMENT

**Press to select any of the following:**

| Message   |
|-----------|
| AM        |
| FM        |
| SIRIUS    |
| CD        |
| USB       |
| BT Stereo |
| SD Card   |

## Using the Audio Controls

**Depending on your vehicle, it may also have the following controls:**

| Controls | Action and Description  |
|----------|---|
| Power    | Switch the media features on or off.  |
| Volume   | Adjust the volume of playing media.   |
| Tune     | Use as you normally would in media modes.   |
| Eject    | Eject a CD from the entertainment system.   |
| Display  | Press this button to switch the display screen off. Press again, or touch the screen to switch the display screen on. |
| Source   | Touch the control repeatedly to switch between media modes.   |
| Sound    | Adjust the settings for:  |
|          | Bass  |
|          | Treble  |

## MyFord Touch™ (If Equipped)

| Controls | Action and Description   |
|----------|--------------------------|
|          | Midrange                 |
|          | Set Balance and Fade     |
|          | DSP                      |
|          | EQ Mode                  |
|          | Speed Compensated Volume |

### Using the Steering Wheel Controls

Depending on your vehicle, it may also have the following controls:

| Control              | Action and Description   |
|----------------------|--|
| VOL                  | Adjust the volume of playing media.  |
| Voice                | Press to start a voice session. Press again to interrupt a voice prompt and begin speaking. Press and hold to end an active voice session. |
| Seek and Call Accept | Use as you normally would in media and phone modes.  |
| Seek and Call Reject | Use as you normally would in media and phone modes.  |

### Using the Touchscreen

- Make sure your hands are clean and dry.
- Press firmly on the center of a control graphic or menu item.
- Keep metal objects or other conductive material away from the surface of the touchscreen.

### Cleaning the Touchscreen Display

Use a dry, clean, soft cloth. If dirt or fingerprints are still visible, apply a small amount of alcohol to the cloth. Do not pour or spray alcohol onto the display. Do not use detergent or any type of solvent to clean the display.

### Support

The SYNC support team is available:

- Monday-Saturday, 8:30am-8:00pm EST.
- United States: 1-888-270-1055
- Canada: 1-800-565-3673

**Note:** *Times are subject to change due to holidays.*

## Safety Information

### WARNING



Driving while distracted can result in loss of vehicle control, crash and injury. We strongly recommend that you use extreme caution when using any device that may take your focus off the road. Your primary responsibility is the safe operation of your vehicle. We recommend against the use of any hand-held device while driving and encourage the use of voice-operated systems when possible. Make sure you are aware of all applicable local laws that may affect the use of electronic devices while driving.

- Do not attempt to service or repair the system. Have your vehicle checked by an authorized dealer.
- Do not operate media devices if the power cables are broken or damaged.

- Make sure the power cables do not interfere with the safe operation of your vehicle's controls or affect your safe driving abilities.
- Some SYNC functions are speed-dependent. Their use is limited to when your vehicle is traveling at speeds below 3 mph (5 km/h).

Make sure that you review your device's manual before using it with SYNC.

## Speed-restricted Features

Some features of this system are restricted from use unless your vehicle is stationary.

- Screens crowded with information, for example:
  - Point of Interest reviews and ratings
  - SIRIUS Travel Link sports scores
  - Movie times
  - Ski conditions.
- Any action that requires keyboard use, for example: entering a navigation destination or editing information.
- All lists are limited, for example: phone contacts.

See the following chart for more specific examples.

| <b>Speed-restricted Features</b> |  |
|----------------------------------|--|
| Cell phone                       | Pairing a cell phone   |
|                                  | Adding or editing phonebook contacts   |
|                                  | Phone contacts and recent phone call entries                                 |
| System Functionality             | Enabling Valet Mode  |
|                                  | Editing settings while the rear view camera or active park assist are active |
| Wi-Fi and Wireless               | Editing wireless settings  |
|                                  | Editing the list of wireless networks  |

# MyFord Touch™ (If Equipped)

| Speed-restricted Features |  |
|---------------------------|--|
| Photos and Graphics       | Adding or editing wallpaper                          |
| Text Messages             | Composing text messages                              |
|                           | Viewing received text messages                       |
|                           | Editing preset text messages                         |
| Navigation                | Using the keyboard to enter a destination            |
|                           | Demo navigation route                                |
|                           | Adding or editing Address Book or Avoid Area entries |

## Privacy Information

When you connect a cell phone to SYNC, the system creates a profile within your vehicle that links to that cell phone. This profile helps in offering you more cellular features and operating more efficiently. Among other things, this profile may contain data about your cell phone book, text messages (read and unread), and call history, including history of calls when your cell phone was not connected to the system. In addition, if you connect a media device, the system creates and retains an index of supported media content. The system also records a short development log of approximately 10 minutes of all recent system activity. The log profile and other system data may be used to improve the system and help diagnose any problems that may occur.

The cellular profile, media device index, and development log remain in your vehicle unless you delete them, and are generally accessible only in your vehicle when your cell phone or media player is connected. If you no longer plan to use the system or your vehicle, we recommend you carry out a Master Reset to erase all stored information.

System data cannot be accessed without special equipment and access to your vehicle's SYNC module. Ford Motor Company and Ford of Canada do not access the system data for any purpose other than as described without consent, a court order, or where required by law enforcement, other government authorities, or other third parties acting with lawful authority. Other parties may seek to access the information independently of Ford Motor Company and Ford of Canada. For further privacy information, see the sections on 911 Assist®, Vehicle Health Report, and Traffic, Directions and Information.

## MyFord Touch™ (If Equipped)

### Accessing and Adjusting Modes Through Your Right Vehicle Information Display



E203474



## MyFord Touch™ (If Equipped)

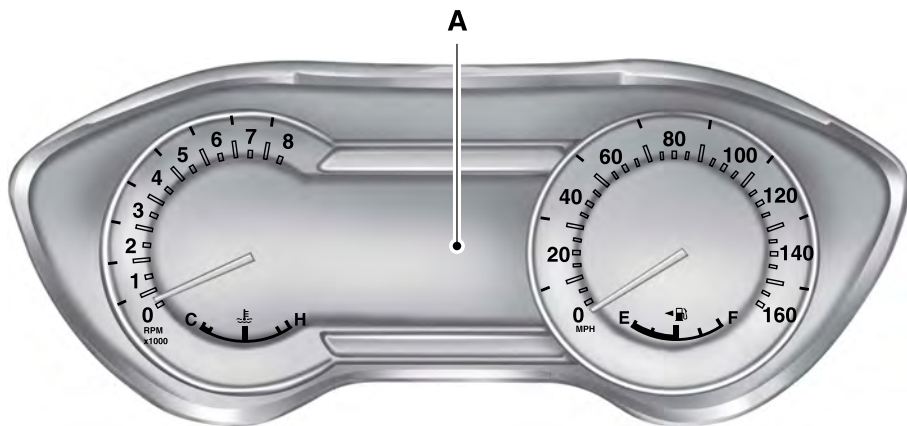

E185883

The display is located on the right side of your instrument cluster (A). You can use your steering wheel controls to view and make minor adjustments to active modes without taking your hands off the wheel. For example:

- In Entertainment mode, you can view what is now playing, change the audio source, select memory presets and make some adjustments.
- In Phone mode, you can accept or reject an incoming call.
- If your vehicle is equipped with Navigation, you can view the current route or activate a route.



E144811

Use the **OK** and arrow buttons on the right side of your steering wheel to scroll through the available modes.

# MyFord Touch™ (If Equipped)

The selection menu expands and different options appear.

- Press the up and down arrows to scroll through the modes.
- Press the right arrow to enter the mode.
- Press the left or right arrows to make adjustments within the chosen mode.
- Press **OK** to confirm your selection.

**Note:** *If your vehicle is not equipped with Navigation, Compass appears in the display instead of Navigation. If you press the right arrow to go into the Compass menu, you can see the compass graphic. The compass displays the direction in which the vehicle is traveling, not true direction (for example, if the vehicle is traveling west, the middle of the compass graphic displays west; north displays to the left of west though its true direction is to the right of west).*

## Using Voice Commands

This system helps you control many features using voice commands. This allows you to keep your hands on the wheel and focus on what is in front of you. The system provides feedback through audible tones, prompts, questions and spoken confirmations depending on the situation and the chosen level of interaction (voice settings).

The system also asks short questions (confirmation prompts) when it is not sure of your request or when there are multiple possible responses to your request.

When using voice commands, words and icons may appear in the lower left status bar indicating the status of the voice command session (such as Listening, Success, Failed, Paused or Try Again).

## How to Use Voice Commands



The following are some of the voice commands that you can say at any time during a voice command session.

## Press the voice button and when prompted say:

| Voice command  |
|----------------|
| Main Menu      |
| What Can I Say |
| Previous Page  |
| Go back        |
| Help           |

## Helpful Hints

- Make sure the interior of your vehicle is as quiet as possible. Wind noise from open windows and road vibrations may prevent the system from correctly recognizing spoken voice commands.
- After pressing the voice command icon, wait until after the tone sounds and a message appears before saying a voice command. Any voice command spoken prior to this does not register with the system.
- Speak naturally, without long pauses between words.
- At any time, you can interrupt the system while it is speaking by pressing the voice command icon.

## Accessing a List of Available Voice Commands

To access a list of available voice commands you can do either of the following.

# MyFord Touch™ (If Equipped)

## Using the touchscreen, press:

| Menu Item          |
|--------------------|
| Settings           |
| Help               |
| Voice Command List |

## Using the steering wheel control, press the voice button and when prompted say one of the following:

| Voice Commands                      |
|-------------------------------------|
| List of Commands                    |
| Radio List of Commands              |
| Phone List of Commands              |
| Voice Instructions List of Commands |

## Voice Command Settings

These allow you to customize the level of system interaction, help and feedback. The system defaults to standard interaction that uses candidate lists and confirmation prompts as these provide the highest level of guidance and feedback.

| Menu Item             | Action and Description   |   |
|-----------------------|--|---|
| Interaction Mode      | Novice   | In this mode the system provides detailed interaction and guidance. |
|                       | Advanced   | This mode has less audible interaction and more tone prompts.       |
| Confirmation Prompts  | The system uses these short questions to confirm your voice command. If turned off, the system simply makes a best guess as to what you requested. The system may still occasionally ask you to confirm a voice command. |   |
| Phone Candidate Lists | Candidate lists are lists of possible results from your voice commands. The system creates these lists when it has the same confidence level of several options based on your voice command.                             |   |
| Media Candidate Lists |  |   |

# MyFord Touch™ (If Equipped)

Using the touchscreen, press the settings icon, then press:

| Menu Item                         |
|-----------------------------------|
| Voice Settings                    |
| Voice Control                     |
| <b>Select from the following:</b> |
| Interaction Mode                  |
| Confirmation Prompts              |
| Media Candidate Lists             |
| Phone Candidate Lists             |
| Voice Control Volume              |

## *Using Voice Commands with the Touchscreen Options*

The voice command system has a dual mode feature which allows you to switch between using voice commands and making on-screen selections. This is available only when the system displays a list of candidates generated during a voice command session. For example, this can be used when entering a street address or trying to call a contact from a cell phone paired to the system.

## SETTINGS



E161968

# MyFord Touch™ (If Equipped)

## Clock

Under this menu, you can set the clock, access and adjust the display, sound and vehicle settings as well as access settings for specific modes or the help feature.

| Item | Message  |
|------|----------|
| A    | Clock    |
| B    | Display  |
| C    | Sound    |
| D    | Vehicle  |
| E    | Settings |
| F    | Help     |

### To make adjustments using the touchscreen, select:

| Menu Item | Action and Description   |
|-----------|--|
| Settings  | Press the settings icon.   |
| Clock     | Press the <b>+</b> or <b>-</b> to adjust the time.<br>From this screen, you can also make other adjustments such as 12-hour or 24-hour mode, activate GPS time synchronization and have the system automatically update new time zones.<br>You can also switch the outside air temperature display off and on. It appears at the top center of the touchscreen, next to the time and date. |

**Note:** You cannot manually set the date. Your vehicle's GPS does this for you.

**Note:** If the battery has been disconnected, your vehicle needs to acquire a GPS signal to update the clock. Once your vehicle acquires the signal, it may take a few minutes for the update to display the correct time.

## Display

You can adjust the display using the touchscreen or the voice button on the steering wheel controls.

### To make adjustments using the touchscreen, select:

| Menu Item | Action and Description   |
|-----------|--------------------------|
| Settings  | Press the settings icon. |
| Display   |                          |

### Then select from the following:

## MyFord Touch™ (If Equipped)

| Menu Item              | Action and Description   |   |
|------------------------|--|---|
| Auto Dim               | When set to <b>On</b> , lets you use the automatic dimming feature. When set to <b>Off</b> you are able to adjust the brightness of the screen.  |   |
|                        | Brightness   | Make the screen display brighter or dimmer.                         |
| Mode                   | Allows you to switch the display off. It also allows you to set the screen to a certain brightness or have the system automatically change based on the outside light level. If you also select: |   |
|                        | Auto   | These features will allow you to adjust the dimming of your screen. |
|                        | Night  |   |
| Auto Dim Manual Offset | Allows you to adjust screen dimming as the outside lighting conditions change from day to night.   |   |
| Edit Wallpaper         | Allows you to display the default photo or upload your own.  |   |



**To make adjustments using the voice button, press the button and when prompted, say:**

| Voice command    |
|------------------|
| Display Settings |

### Uploading Photos for Your Home Screen Wallpaper

**Note:** You cannot load photos directly from your camera. You must access the photos either from your USB mass storage device or from an SD card.

**To upload your photos, select:**

| Menu Item      | Action and Description                                |
|----------------|---|
| Settings       | Press the settings icon.                              |
| Display        |   |
| Edit Wallpaper | Follow the system prompts to upload your photographs. |

**Note:** Photographs with extremely large dimensions (such as 2048 x 1536) may not be compatible and appear as a blank (black) image on the display.

The system allows you to upload and view up to 32 photos.

# MyFord Touch™ (If Equipped)

Only the photograph(s), which meets the following conditions display:

- Compatible file formats are as follows: JPG, GIF, PNG, BMP.
- Each file must be 1.5 MB or less.
- Recommended dimensions: 800 x 384.

## Sound

**To make adjustments using the touchscreen, select:**

| Message                                |
|--|
| Settings                               |
| Sound                                  |
| <b>Then select from the following:</b> |
| Bass                                   |
| Midrange                               |
| Treble                                 |
| Set Balance and Fade                   |
| Occupancy Mode                         |
| Speed Compensated Volume               |
| DSP                                    |

**Note:** *Your vehicle may not have all of these sound settings.*

**To make adjustments using the touchscreen, select:**

| Menu Item        | Action and Description   |
|------------------|--------------------------|
| Settings         | Press the settings icon. |
| Vehicle          |                          |
| Ambient Lighting |                          |

- You can then touch the desired color.
- Use the scroll bar to increase or decrease the intensity.
- To switch the feature on or off, press the power button.

## Vehicle

**To make adjustments using the touchscreen, select:**

| Message                                |
|--|
| Settings                               |
| Vehicle                                |
| <b>Then select from the following:</b> |
| Ambient Lighting                       |
| Vehicle Health Report *                |
| Camera Settings                        |
| Enable Valet Mode                      |

\* US only

## Ambient Lighting (If Equipped)

When you switch this feature on, ambient lighting illuminates the dashboard, footwells, doors, cupholders, and console with a choice of colors.

# MyFord Touch™ (If Equipped)

## Vehicle Health Report (If Equipped, US Only)

To make adjustments using the touchscreen, select:

| Message   | Action and Description   |
|---|--|
| Settings  | Press the settings icon.   |
| Vehicle   |  |
| Vehicle Health                                  |  |
| Automatic Reminders<br>Mileage Interval (Miles) | Turn on and off and set the mileage interval at which you would like to receive the reports. Press the ? for more information on these selections. |
| Run Vehicle Health Report Now                   | To run the vehicle health report immediately.  |

You can find more information on Vehicle Health Report in this chapter.

## Camera Settings

To make adjustments using the touchscreen, select:

| Message                                | Action and Description   |
|--|--------------------------|
| Settings                               | Press the settings icon. |
| Vehicle                                |                          |
| Camera Settings                        |                          |
| <b>Then select from the following:</b> |                          |
| Enhanced Park Aids                     |                          |
| Rear Camera Delay                      |                          |

You can find more information on the rear view camera system in another chapter. See **Parking Aids** (page 194).

## Enable Valet Mode

**Note:** If the system locks, and you need to reset the PIN, please contact the Customer Relationship Center.

United States: 1-800-392-3673  
Canada: 1-800-565-3673



# MyFord Touch™ (If Equipped)

## To make adjustments using the touchscreen, select:

| Menu Item         | Action and Description   |
|-------------------|--|
| Settings          | Press the settings icon.   |
| Vehicle           |  |
| Enable Valet Mode | Then enter a four digit PIN twice, as prompted.                          |
| Continue          | After you press Continue the system locks until you enter the PIN again. |

## Settings

Access and adjust system settings, voice features, as well as phone, navigation and wireless settings.

## System

### To make adjustments using the touchscreen, select:

| Message                                | Action and Description   |
|--|--|
| Settings                               | Press the settings icon.   |
| System                                 |  |
| <b>Then select from the following:</b> |  |
| Language                               | Select to have the touchscreen display in English, Spanish or French.                    |
| Distance                               | Select to display units in kilometers or miles.  |
| Temperature                            | Select to display units in Celsius or Fahrenheit.  |
| System Prompt Volume                   | Adjust the volume of voice prompts from the system.                                      |
| Touch Screen Button Beep               | Select to have the system beep to confirm choices made through the touchscreen.          |
| Keyboard Layout                        | Have the touchscreen keyboard display in QWERTY or ABC format.                           |
| Install Applications                   | Install any downloaded applications or view the current software licenses.               |
| Master reset                           | Select to restore factory defaults. This erases all personal settings and personal data. |

# MyFord Touch™ (If Equipped)

## Voice Control

**To make adjustments using the touchscreen, select:**

| Message                                | Action and Description  |
|--|---|
| Settings                               |   |
| Voice Control                          |   |
| <b>Then select from the following:</b> |   |
| Interaction Mode                       | Novice interaction mode provides more detailed interaction and guidance. Advanced mode has less audible interaction and more tone prompts.  |
| Confirmation Prompts                   | Have the system ask you short questions if it has not clearly heard or understood your request.<br><b>Note:</b> Even with confirmation prompts turned off, the system may occasionally ask you to confirm settings. |
| Media Candidate Lists                  | Candidate lists are possible results from your voice commands. The system simply makes a best guess at your request with these turned off.  |
| Phone Candidate Lists                  | Candidate lists are possible results from your voice commands. The system simply makes a best guess at your request with these turned off.  |
| Voice Control Volume                   | This allows you to adjust the system's voice volume level.  |

## Media Player

**To make adjustments using the touchscreen, select:**

| Message                                | Action and Description   |
|--|--|
| Settings                               | Press the settings icon.   |
| Media Player                           |  |
| <b>Then select from the following:</b> |  |
| Autoplay                               | When this feature is on, the system automatically switches to the media source upon initial connection. This allows you to listen to music during the indexing process. When this feature is off, the system does not automatically switch to the inserted media source. |

## MyFord Touch™ (If Equipped)

| Message                  | Action and Description   |
|--------------------------|--|
| Bluetooth Devices        | Select to connect, disconnect, add or delete a device. You can also set a device as your favorite so that the system automatically attempts to connect to that device at every ignition cycle. |
| Gracenote® Database Info | This allows you to view the version level of the Gracenote Database.   |
| Gracenote® Management    | With this feature on, the Gracenote Database supplies metadata information for your music files. This overrides information from your device. This feature defaults to off.                    |
| Cover Art Priority       | With this feature on, the Gracenote Database supplies cover art for your music files. This overrides any art from your device. This feature defaults to Media Player.                          |

### Navigation

**To make adjustments using the touchscreen, select:**

| Message    | Action and Description   |
|------------|--------------------------|
| Settings   | Press the settings icon. |
| Navigation |                          |

**Then select from the following:**

|                   |  |
|-------------------|--|
| Map Preferences   | Turn breadcrumbs on and off.   |
|                   | Have the system display your turn list top to bottom or bottom to top.   |
|                   | Turn the Parking POI notification on and off.  |
| Route Preferences | Select shortest route, fastest route or ecological route as your preferred route. This route will be displayed first.                    |
|                   | Always use preferred route. If set to yes, the system will only calculate a single route. This speeds up your destination entry process. |
|                   | Select a low, medium or high cost for the calculated ecological route. This may incur a time penalty.                                    |
|                   | Have the system avoid freeways.  |
|                   | Have the system avoid toll roads.  |

## MyFord Touch™ (If Equipped)

| Message                | Action and Description   |
|------------------------|--|
|                        | Have the system avoid ferries or car trains.   |
|                        | Have the system use HOV (high-occupancy vehicle) lanes.  |
| Navigation Preferences | Have the system use guidance prompts.  |
|                        | Have the system automatically fill-in State/Province information.  |
| Traffic Preferences    | Have the system automatically avoid traffic concerns or allow you to accept or decline an alternative route. |
|                        | Have the system automatically alert you to traffic concerns that occur on your route.                        |
|                        | Have the system display accident icons.  |
|                        | Have the system display traffic jam icons.   |
|                        | Have the system display closed roads.  |
|                        | Have the system display areas where road work occurs.  |
|                        | Have the system display incident icons.  |
|                        | Have the system display areas where difficult driving conditions may occur.                                  |
|                        | Have the system display areas where snow and ice on the road may occur.                                      |
|                        | Have the system display any smog alerts.   |
|                        | Have the system display weather warnings.  |
|                        | Have the system display where there may be reduced visibility.   |
|                        | Have the system turn on your radio for traffic announcements.  |
| Avoid Areas            | Enter specific areas that would like to avoid on planned navigation routes.                                  |

# MyFord Touch™ (If Equipped)

## Phone

### To make adjustments using the touchscreen, select:

| Message                                | Action and Description  |
|--|---|
| Settings                               | Press the settings icon.  |
| Phone                                  |   |
| <b>Then select from the following:</b> |   |
| Bluetooth Devices                      | Connect, disconnect, add or delete a device, as well as save it as a favorite.  |
| Bluetooth                              | Turn Bluetooth on and off.  |
| Do Not Disturb                         | Have all calls go directly to your voice mail and not ring inside your vehicle. With this feature turned on, text message notifications are also suppressed and do not ring inside your vehicle.  |
| 911 Assist                             | Turn on or turn off the 911 Assist feature. See <b>Information</b> (page 450).  |
| Phone Ringer                           | Select the type of notification for phone calls - ring tone, beep, text to speech or silent.  |
| Text Message Notification              | Select the type of notification for text messages - alert tone, beep, text to speech, or have it be silent.   |
| Internet Data Connection               | If compatible with your phone, you can adjust your internet data connection. Select to make your connection profile with the personal area network or to turn off your connection. You can also choose to adjust your settings or have the system always connect, never connect when roaming, or query on connect. Press <b>?</b> for more information. |
| Manage Phonebook                       | Access features, such as automatic phonebook download, re-download your phonebook, add contacts from your phone as well as delete or upload your phonebook.   |
| Roaming Warning                        | Have the system alert you when in Roaming mode.   |

# MyFord Touch™ (If Equipped)

## Wireless and Internet

Your system has a Wi-Fi feature that creates a wireless network within your vehicle, thereby allowing other devices (such as personal computers or phones) in your vehicle to speak to each other,

share files or play games. Using this Wi-Fi feature, everyone in your vehicle can also access the internet if you have a USB mobile broadband connection inside your vehicle, your phone supports personal area networking or if you park outside a wireless hotspot.

### To make adjustments using the touchscreen, select:

| Menu Item                              | Action and Description   |
|--|--|
| Settings                               | Press the settings icon.   |
| Wireless & Internet                    |  |
| <b>Then select from the following:</b> |  |
| Wi-Fi Settings                         | Wi-Fi Network (Client) Mode<br>Turns the Wi-Fi feature on and off in your vehicle. Make sure you switch it on for connectivity purposes.   |
|  | Choose a Wireless Network<br>Allows you to use a previously stored wireless network. You can categorize by alphabetical listing, priority and signal strength. You can also choose to search for a network, connect to a network, disconnect from a network, receive more information, prioritize a network or delete a network. |
|  | Gateway (Access Point) Mode<br>Makes SYNC an access point for a phone or a computer when turned on. This forms the local area network within your vehicle for things, such as game playing, file transfer and internet browsing. Press ? for more information.   |
|  | Gateway (Access Point) Settings<br>Allows you to view and change settings for using SYNC as the internet gateway.  |
|  | Gateway (Access Point) Devices List<br>Allows you to view recent connections to your Wi-Fi system.   |

## MyFord Touch™ (If Equipped)

| Menu Item                     | Action and Description   |
|-------------------------------|--|
| USB Mobile Broadband          | Instead of using Wi-Fi, your system can also use a USB mobile broadband connection to access the internet. (You must switch on your mobile broadband device on your personal computer before connecting it to the system.) This screen allows you to set up what is your typical area for your USB mobile broadband connection. (USB mobile broadband settings may not display if the device is already on.) You can select the following: |
|                               | Country  |
|                               | Carrier  |
|                               | Phone Number   |
|                               | User Name  |
|                               | Password   |
| Bluetooth Settings            | Shows you the currently paired devices as well as giving you your typical Bluetooth options to connect, disconnect, set as favorite, delete and add device. Bluetooth is a registered trademark of the Bluetooth SIG.  |
| Prioritize Connection Methods | Choose your connection methods and change them as needed. You can select to change order and have the system either always attempt to connect using a USB, mobile broadband, or using Wi-Fi.   |

The Wi-Fi CERTIFIED Logo is a certification mark of the Wi-Fi Alliance.



E142626

# MyFord Touch™ (If Equipped)

## Help

### To make adjustments using the touchscreen, select:

| Message                                | Action and Description  |   |
|--|---|---|
| Settings                               | Press the settings icon.  |   |
| Help                                   |   |   |
| <b>Then select from the following:</b> |   |   |
| System Information                     | Touchscreen system serial number  |   |
|  | Your vehicle identification number (VIN)  |   |
|  | Touchscreen system software version   |   |
|  | Navigation system version   |   |
|  | Map database version  |   |
|  | Sirius satellite radio ESN  |   |
|  | Gracenote® Database Information and Library version                             |   |
| Software Licenses                      | View the licenses for any software and applications installed on your system.   |   |
| Driving Restrictions                   | Certain features are not accessible when your vehicle is moving.                |   |
| 911 Assist                             | Turn on and turn off the 911 Assist feature. See <b>Information</b> (page 450). |   |
|  | In Case of Emergency (ICE) Quick Dial   | Allows you to save up to two numbers as ICE contacts for quick access if there is an emergency. The ICE contacts you select appear at the end of the Emergency Assistance call process. |
|  | Edit  | Select to access your phonebook and then select the desired contacts. The numbers then appear as options on this screen for the ICE 1 and ICE 2 buttons.                                |
| Voice Command List                     | View categorized lists of voice commands.                                       |   |



# MyFord Touch™ (If Equipped)



You can also access Help using the voice commands. The system provides allowable voice commands for the current mode.

**Press the voice button and when prompted say:**

| Voice command |
|---------------|
| Help          |

You can say help at any time to get assistance with commands, menus or other information.

## ENTERTAINMENT



E161892

| Message | Message and Description  |
|---------|--|
| A       | AM   |
| B       | FM   |
| C       | SIRIUS   |
| D       | CD   |
| E       | USB  |
| F       | Touch this button to scroll down for more options, for example SD Card and USB |

## MyFord Touch™ (If Equipped)

| Message | Message and Description                              |
|---------|--|
| G       | These buttons change with the media mode you are in. |
| H       | Radio memory presets.                                |

**Note:** Some features may not be available in your area. Contact an authorized dealer for more information.

You can access these options using the touchscreen or voice commands.

### AM/FM Radio

The following controls are available for AM/FM radio

| Item        | Action and Description  |
|-------------|---|
| AM<br>FM    | Touch either tab to listen to the radio. To change between AM and FM presets, just touch the <b>AM</b> or <b>FM</b> tab.  |
| Presets     | Save a station by pressing and holding one of the memory preset areas. There is a brief mute while the radio saves the station. Sound returns when finished.  |
| HD Radio    | Touch this button to turn HD Radio on. The light on the button illuminates when the feature is on. HD Radio allows you to receive radio broadcasts digitally, where available, providing free, crystal-clear sound. See HD Radio information later in this chapter. |
| Options     | Touch this button to make adjustments to your audio settings.   |
| Scan        | Touch this button to go to the next strong AM or FM radio station. The light on the button illuminates when the feature is on.  |
| Direct Tune | Touch this button to manually enter the desired station number. Touch <b>Enter</b> when you are done.   |

### Options

**You can make adjustments to the following options:**

| Menu Item      | Action and Description                    |
|----------------|---|
| Sound Settings | Touch this button to adjust settings for: |
|                | Bass                                      |
|                | Midrange                                  |
|                | Treble                                    |

## MyFord Touch™ (If Equipped)

| Menu Item               | Action and Description   |
|-------------------------|--|
|                         | Set Balance and Fade   |
|                         | DSP  |
|                         | Occupancy Mode   |
|                         | Speed Compensated Volume   |
| Set PTY for Seek / Scan | This allows you to select a category of music you would like to search for. You can then choose to either seek or scan for the stations playing that category.   |
| RDS Text Display        | This allows you to view the information broadcast by FM stations.  |
| AST                     | AST (Autostore) allows you to have the system automatically store the six strongest stations in your current location.   |
| TAG Button              | This feature is available when HD Radio is on, and allows you to tag a song to download later. When you select On, <b>TAG</b> appears on-screen when HD Radio is active. You can touch <b>TAG</b> to save the information of the song that is playing. When you plug in your portable music player, the information transfers, if supported by your device. When you are connected to iTunes, the tags appear to remind you of the songs you would like to download. See HD Radio information later in this chapter. |

**Note:** Your vehicle may not have all these sound settings.

### HD Radio™ Information (If Available)

**Note:** HD Radio broadcasts are not available in all markets.

HD Radio technology is the digital evolution of analog AM/FM radio. Your system has a special receiver that allows it to receive digital broadcasts (where available) in addition to the analog broadcasts, it already receives. Digital broadcasts provide a better sound quality than analog broadcasts with free, crystal-clear audio and no static or distortion. For more information, and a guide to available stations and programming, please visit [www.hdradio.com](http://www.hdradio.com).

When HD Radio is on and you tune to a station broadcasting HD Radio technology, you may notice the following indicators on your screen:



E142616

## MyFord Touch™ (if Equipped)

The HD logo either blinks when acquiring a digital station, and then stays solid when digital audio is playing, or is grey when acquiring a digital station, and then changes to orange when digital audio is playing. When this logo is available, you may also see Title and Artist fields on-screen.

The multicast indicator appears in FM mode (only) if the current station is broadcasting multiple digital broadcasts. The highlighted numbers signify available digital channels where new or different content is available. HD1 signifies the main programming status and is available in analog and digital broadcasts. Other multicast stations (HD2 through HD7) are only available digitally.

**TAG** allows you to save a song to download later when you are on an acquired HD Radio station and the feature is on.

### To turn the feature on and use it, select AM or FM and the select:

| Message    | Action and Description  |
|------------|---|
| Options    |   |
| TAG Button |   |
| On         | When you hear a song you want to tag, select:   |
| TAG        | The system automatically saves the song's information and transfers it to your portable music player (if supported) when you connect it to the system. The system automatically transfers the tag to your player (if already connected) and a pop-up confirms the transfer. When you access iTunes with your portable music player, the tags appear to you as a reminder. The system allows you to tag up to approximately 100 songs. For a list of devices that support tagging, see <a href="http://www.SYNMyRide.com">www.SYNMyRide.com</a> , <a href="http://www.SYNMyRide.ca">www.SYNMyRide.ca</a> or <a href="http://www.sync-maroute.ca">www.sync-maroute.ca</a> |

## MyFord Touch™ (If Equipped)

### When HD Radio broadcasts are active, you can access the following functions:

| Message | Action and Description   |
|---------|--|
| Scan    | Allows you to hear a brief sampling of all available stations. Press this buttons again to listen to a station. This feature still works when HD Radio reception is on, although it does not scan for HD2–HD7 channels. You may see the HD logo appear if the station has a digital broadcast.   |
| Presets | Allows you to save an active channel as a memory preset. Touch and hold a memory preset slot until the sound returns. There is a brief mute while the radio saves the station. Sound returns when finished. When switching to an HD2 or HD3 memory preset, the sound mutes before the digital audio plays, because the system has to reacquire the digital signal. |

**Note:** As with any saved radio station, you cannot access the saved station if your vehicle is outside the station's reception area.

### HD Radio Reception and Station Troubleshooting

| Potential reception issues |   |
|----------------------------|---|
| Reception area             | <p>If you are listening to a multicast station and you are on the fringe of the reception area, the station may mute due to weak signal strength.</p> <p>If you are listening to HD1, the system switches back to the analog broadcast until the digital broadcast is available again. However, if you are listening to any of the possible HD2–HD7 multicast channels, the station mutes and stays muted unless it is able to connect to the digital signal again.</p> |
| Station blending           | When the system first receives a station (aside from HD2–HD7 multicast stations), it first plays the station in the analog version. Once the receiver verifies the station is an HD Radio station, it shifts to the digital version. Depending on the station quality, you may hear a slight sound change when the station changes from analog to digital. Blending is the shift from analog to digital sound or digital back to analog sound.                          |

In order to provide the best possible experience, use the contact form to report any station issues found while listening to a station broadcasting with HD Radio technology. Independent entities own and operate each station. These stations are responsible for ensuring all audio streams and data fields are accurate.

## MyFord Touch™ (If Equipped)

| Potential station issues   |   |  |
|--|---|--|
| Issues   | Cause   | Action   |
| Echo, stutter, skip or repeat in audio.<br>Increase or decrease in audio volume.               | This is poor time alignment by the radio broadcaster.   | No action required. This is a broadcast issue.   |
| Sound fading or blending in and out.   | The radio is shifting between analog and digital audio.   | No action required. The reception issue may clear up as you continue to drive.   |
| There is an audio mute delay when selecting HD2 or HD3, multicast preset or <b>Direct Tune</b> | The digital multicast is not available until the HD Radio broadcast is decoded. Once decoded, the audio is available. | No action required. This is normal behavior. Wait until the audio is available.  |
| Cannot access HD2 or HD3 multicast channel when recalling a preset or from a direct tune.      | The previously stored multicast preset or direct tune is not available in your current reception area.                | No action required. The station is not available in your current location.   |
| Text information does not match currently playing audio.                                       | Data service issue by the radio broadcaster.  | Fill out the station issue form at <a href="http://www.ibiquity.com/automotive/report_radio_station_experiences">http://www.ibiquity.com/automotive/report_radio_station_experiences</a> |
| There is no text information shown for currently selected frequency.                           | Data service issue by the radio broadcaster.  | Fill out the station issue form at <a href="http://www.ibiquity.com/automotive/report_radio_station_experiences">http://www.ibiquity.com/automotive/report_radio_station_experiences</a> |
| HD2-HD7 stations not found when you press <b>Scan</b>  | This selection disables HD2-HD7 channel search.   | No action required. This is normal behavior.   |

## MyFord Touch™ (If Equipped)

HD Radio Technology manufactured under license from iBiquity Digital Corp. U.S. and foreign patents. HD Radio and the HD and HD Radio logos are proprietary trademarks of iBiquity Digital Corp. Ford Motor Company and iBiquity Digital Corp. are not responsible for the content sent using HD Radio technology. Content may be

changed, added or deleted at any time at the station owner's discretion.

### Radio Voice Commands



**Press the voice button and when prompted say:**

| Voice command   | Action and Description     |
|---|----------------------------|
| Radio   |                            |
| <b>Then you can say a command similar to the following:</b> |                            |
| FM  | Say a frequency or preset. |
| Off   |                            |
| Help  |                            |

### SIRIUS® Satellite Radio (If Activated)

**To turn the feature on press the lower left corner of the touchscreen, and then select:**

| Menu Item  | Action and Description   |
|--|--|
| SIRIUS   |  |
| <b>You can then select any of the following:</b> |  |
| Presets  | Save a channel by pressing and holding one of the memory preset areas. There is a brief mute while the radio saves the channel. Sound returns when finished.   |
| Alerts   | Save the current song, artist, or team as a favorite. If you are listening to music, you can save the song or artist, so the system can alert you when they are playing on a satellite radio channel. If you are listening to a sporting event, you can save your favorite teams so the system can alert you when they are playing on a satellite radio channel. You can also edit alerts or turn alerts on or off. When an alert appears on the screen, you can choose to tune to the channel, cancel the alert or turn off alerts. |

## MyFord Touch™ (If Equipped)

| Menu Item | Action and Description   |
|-----------|--|
| Replay    | <p>Replay audio on the current channel. You can replay approximately 45 minutes of audio as long as you have remained tuned to the current station. Changing stations erases the previous audio.</p> <p>While in replay mode:</p> <p>Press and release the seek buttons to hear the previous or next song.</p> <p>Press and hold the seek buttons to reverse or fast forward in the current track.</p> <p>Press play or pause to play or pause the audio.</p> <p>Press the button again to return to live audio.</p> |
| Scan      | Touch this button to hear a brief sampling of channels.  |
| Browse    | Touch this button to view a list of all available stations. Scroll to see more categories. Touch the station you want to listen to.  |

**Note:** SIRIUS does not support the Alert feature on all channels. Ford Motor Company shall not be responsible for Alert feature variation.

### Browsing Controls

| Message | Action and Description   |
|---------|--|
| Skip    | Touch this button if you want to skip this channel.                    |
| Lock    | Touch this button if you do not want anyone to listen to this channel. |
| Title   | Touch this button to see song titles playing on other stations.        |
| Artist  | Touch this button to see artists playing on other stations.            |
| Channel | Touch this button to see a list of all the channel names.              |

### Options

Touch this button to view and adjust various media settings.

| Message        | Message                                   |
|----------------|---|
| Sound Settings | Touch this button to adjust settings for: |
|                | Bass                                      |
|                | Midrange                                  |
|                | Treble                                    |



## MyFord Touch™ (If Equipped)

| Message                        | Message  |
|--------------------------------|--|
|                                | Set Balance and Fade   |
|                                | DSP  |
|                                | Occupancy Mode   |
|                                | Speed Compensated Volume   |
| Set Category for Seek/Scan     | This allows you to select a category of music you would like to search for. You can then choose to either seek or scan for the stations playing that category. |
| Parental Lockout               | This allows you to lock and unlock channels, change or reset your PIN or unlock all channels. To use this feature, you need your initial PIN, which is 1234.   |
| Artist / Title / Team Alerts   | This feature allows you turn alerts on and off.  |
| Electronic Serial Number (ESN) | SIRIUS requires this number when communicating with you about your account.  |
| Direct Tune                    | Touch this button to manually enter the desired satellite channel number. Touch <b>Enter</b> when you are done   |

**Note:** Your vehicle may not have all these sound settings.

### SIRIUS Satellite Radio Information

**Note:** SIRIUS reserves the unrestricted right to change, rearrange, add or delete programming including canceling, moving or adding particular channels, and its prices, at any time, with or without notice to you. Ford Motor Company shall not be responsible for any such programming changes.



E142593

SIRIUS satellite radio is a subscription-based satellite radio service that broadcasts a variety of music, sports, news, weather, traffic and entertainment programming. Your factory-installed SIRIUS satellite radio system includes hardware and a limited subscription term that begins on the date of sale or lease of your vehicle. See an authorized dealer for availability.

For more information on extended subscription terms (a service fee is required), the online media player and a list of SIRIUS satellite radio channels, and other features, please visit [www.siriusxm.com](http://www.siriusxm.com) in the United States, [www.sirius.ca](http://www.sirius.ca) in Canada, or call SIRIUS at 1-888-539-7474.

**Note:** This receiver includes the eCos real-time operating system. eCos is published under the eCos License.

# MyFord Touch™ (If Equipped)

## Satellite Radio Electronic Serial Number (ESN)

You need your ESN to activate, modify or track your satellite radio account. The ESN is on the System Information Screen (SR ESN:XXXXXXXXXXXX).

**To access your ESN, touch the bottom left corner of the touchscreen, then select:**

| Message |
|---------|
| SIRIUS  |
| Options |

## SIRIUS Satellite Radio Reception Factors and Troubleshooting

| Potential reception issues          |   |
|-------------------------------------|---|
| Antenna obstruction                 | For optimal reception performance, keep the antenna clear of snow and ice build-up and keep luggage and other materials as far away from the antenna as possible. |
| Terrain                             | Hills, mountains, tall buildings, bridges, tunnels, freeway overpasses, parking garages, dense tree foliage and thunderstorms can interfere with your reception.  |
| Station overload                    | When you pass a ground-based broadcast-repeating tower, a stronger signal may overtake a weaker one and the audio system may mute.                                |
| Satellite radio signal interference | Your display may show ACQUIRING... to indicate the interference and the audio system may mute.  |

| Troubleshooting tips                             |   |  |
|--|---|--|
| Message  | Cause   | Action   |
| Acquiring...                                     | Radio requires more than two seconds to produce audio for the selected channel. | No action required. This message should disappear shortly.   |
| Satellite antenna fault<br>SIRIUS system failure | There is an internal module or system failure present.                          | If this message does not clear shortly, or with an ignition key cycle, your receiver may have a fault. See an authorized dealer for service. |
| Invalid Channel                                  | The channel is no longer available.   | Tune to another channel or choose another preset.  |

## MyFord Touch™ (If Equipped)

| Troubleshooting tips              |   |   |
|-----------------------------------|---|---|
| Message                           | Cause   | Action  |
| Unsubscribed Channel              | Your subscription does not include this channel.                                      | Contact SIRIUS at 1-888-539-7474 to subscribe to the channel, or tune to another channel. |
| No Signal                         | The signal is lost from the SIRIUS satellite or SIRIUS tower to your vehicle antenna. | The signal is blocked. When you move into an open area, the signal should return.         |
| Updating...                       | Update of channel programming in progress.  | No action required. The process may take up to three minutes.                             |
| Questions? Call 1-888-539-7474    | Your satellite service is no longer available.  | Contact SIRIUS at 1-888-539-7474 to resolve subscription issues.                          |
| None found<br>Check Channel Guide | All the channels in the selected category are either skipped or locked.               | Use the channel guide to turn off the Lock or Skip function on that station.              |
| Subscription Updated              | SIRIUS has updated the channels available for your vehicle.                           | No action required.   |

### SIRIUS Satellite Radio Voice Commands



If you are listening to SIRIUS satellite radio, press the voice button on the steering wheel controls. You will hear a prompt, you can then say any of the commands in the following table.

**If you are not listening to SIRIUS satellite radio, press the voice button and, after the tones press the voice button and when prompted say:**

| Voice command  |
|--|
| Sirius   |
| <b>You can then say any of the following or a similar command:</b> |
| SAT 1  |
| Sports Games   |

# MyFord Touch™ (If Equipped)

| Voice command   |
|---|
| Tune  |
| Help  |
| You can also say the name of any Sirius station, such as "The Highway" or "Deep Tracks", to listen to that station. |

## CD

**To access, press the lower left corner on the touchscreen, then select:**

| Menu Item |
|-----------|
| CD        |

### Insert your CD then select:

| Menu Item | Action and Description   |
|-----------|--|
| Repeat    | Touch this button to repeat the currently playing track, all tracks on the disc or switch the feature off if already on. |
| Shuffle   | Touch this button to play the tracks or entire albums in random order, or switch the feature off if already on.          |
| Scan      | Touch this button to hear a brief sampling of all available tracks.  |
| More Info | Touch this button to see disc information.   |
| Browse    | Touch this button to look through all available CD tracks.   |

### To adjust the Sound Settings, select:

| Menu Item                         |
|-----------------------------------|
| Options                           |
| Sound Settings                    |
| <b>Then any of the following:</b> |
| Bass                              |
| Midrange                          |
| Treble                            |
| Set Balance and Fade              |

| Menu Item                |
|--------------------------|
| Occupancy Mode           |
| EQ Mode                  |
| Speed Compensated Volume |

**Note:** *Your vehicle may not have all these sound settings.*

### CD Voice Commands

If you are listening to a CD, press the voice button on the steering wheel controls. When prompted, say any of the following commands.

# MyFord Touch™ (If Equipped)

If you are not listening to a CD, press the voice button and, after the tone, say:

| Voice command |
|---------------|
| CD Player     |

When listening to a CD you can say many commands. Following are a few examples of what you can say.

| Voice command  |
|----------------|
| Play           |
| Pause          |
| Next Track     |
| Previous Track |
| Help           |

\*This applies to WMA or MP3 files only.

## SD Card Slot and USB Port

The SD card slot and USB port are located in the Media Hub. See **Media Hub** (page 365).

### SD Card

**Note:** Your SD card slot is spring-loaded. To remove the SD card, press the card in and the system ejects it. Do not attempt to pull the card to remove it as this could cause damage.

**Note:** The navigation system also uses this card slot. See **Navigation** (page 464).

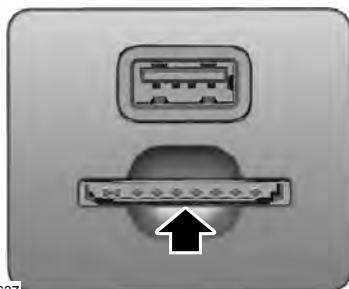

E196637

To access and play music from your device, press the lower left corner of the touchscreen.



E142620

SD logo is a trademark of SD-3C, LLC.

### USB Port

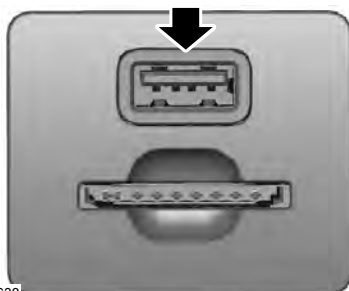

E196638

To access and play music from your device, press the lower left corner of the touchscreen.

## MyFord Touch™ (If Equipped)

This feature allows you to plug in media playing devices, memory sticks, flash drives or thumb drives, and charge devices if they support this feature.

### Playing Music from Your Device

**Note:** *The system is capable of indexing up to 30,000 songs.*

#### Insert your device and select:

| Message        | Action and Description  |
|----------------|---|
| USB<br>SD Card | Once the system recognizes your USB or SD card you can then select from the following options:      |
| Repeat         | This feature replays the currently playing song or album.   |
| Shuffle        | Touch this button to play music on the selected album or folder in random order.                    |
| Similar Music  | This feature allows you to choose music similar to what is currently playing.                       |
| More Info      | Touch this button to see disc information, for example current track, artist name, album and genre. |
| Options        | Touch this button to view and adjust various media settings.  |

### Sound

#### You can adjust the settings for:

| Message               | Action and Description   |
|-----------------------|--|
| Sound Settings        | Bass   |
|                       | Midrange   |
|                       | Treble   |
|                       | Set Balance and Fade   |
|                       | DSP  |
|                       | EQ Mode  |
|                       | Speed Compensated Volume   |
| Media Player Settings | Allows you to select more settings, which is under Media Player. See <b>Settings</b> (page 414). |

## MyFord Touch™ (If Equipped)

| Message            | Action and Description  |
|--------------------|---|
| Device Information | Displays software and firmware information about the currently connected media device.  |
| Update Media Index | Indexes your device when you connect it for the first time and each time the content changes (for example adding or removing tracks) to make sure you have the latest voice commands available for all media on the device. |

**Note:** *Your vehicle may not have all these sound settings.*

### Browse

This feature allows you to view the contents of the device. It also allows you to search by categories, for example genre, artist or album.

If you want to view song information, for example Title, Artist, File, Folder, Album, and Genre, touch the on-screen album art.

### You can also select:

| Message         | Action and Description   |
|-----------------|--|
| What's Playing? | To hear how the system pronounces the current band and song. This can be helpful when using voice commands to make sure the system correctly plays your request. |

## USB and SD Card Voice Commands



### Press the voice button and when prompted say:

| Voice command                               |   |
|---|---|
| SD Card                                     |   |
| USB   |   |
| <b>Then commands such as the following:</b> |   |
| Browse                                      |   |
| Next Track                                  |   |
| Pause                                       |   |
| Play  | Say the name of what you would like to listen to such as a band, song, album or playlist. |

# MyFord Touch™ (If Equipped)

| Voice command    |   |
|------------------|---|
| Play Artist ____ | * |
| Play Song ____   | * |
| Similar Music    |   |
| Help             |   |

\* \_\_\_\_ is a dynamic listing, meaning that it could be the name of anything, such as a group, artist or song. For example you could say "Play artist The Beatles" or "Play song Penny Lane".

## Supported Media Players, Formats and Metadata Information

SYNC is capable of hosting nearly any digital media player, including iPod, Zune™, plays from device players, and most USB drives. Supported audio formats include MP3, WMA, WAV and AAC.

It is also able to organize your indexed media from your playing device by metadata tags. Metadata tags, which are descriptive software identifiers embedded in the media files, provide information about the file.

If your indexed media files contain no information embedded in these metadata tags, SYNC may classify the empty metadata tags as unknown.

## Bluetooth Audio

The system allows you to stream audio over your vehicle's speakers from your connected, Bluetooth-enabled cell phone.

**To access, press the lower left corner on the touchscreen, then select:**

| Message   |
|-----------|
| BT Stereo |

## Bluetooth Audio Voice Commands



The voice system allows you to control your media with a simple voice command. For example to change songs, press the voice button and follow the system prompts.



## PHONE



E161968

| Item | Message    |
|------|------------|
| A    | Phone      |
| B    | Quick Dial |
| C    | Phonebook  |
| D    | History    |
| E    | Messaging  |
| F    | Settings   |

Hands-free calling is one of the main features of SYNC. Once you pair your cell phone, you can access many options using the touchscreen or voice commands. While the system supports a variety of features, many are dependent on your cell phone's functionality.

At a minimum, most cell phones with Bluetooth wireless technology support the following functions:

- Answering an incoming call.
- Ending a call.
- Using privacy mode.
- Dialing a number.
- Redialing.
- Call waiting notification.
- Caller ID.

Other features, such as text messaging using Bluetooth and automatic phonebook download, are cell phone-dependent features. To check your cell phone's compatibility, see your cell phone's user manual and visit [www.SYNCMYRide.com](http://www.SYNCMYRide.com), [www.SYNCMYRide.ca](http://www.SYNCMYRide.ca) or [www.syncmaroute.ca](http://www.syncmaroute.ca).

# MyFord Touch™ (If Equipped)

## Pairing Your Cell Phone for the First Time

### WARNING



Driving while distracted can result in loss of vehicle control, crash and injury. We strongly recommend that you use extreme caution when using any device that may take your focus off the road. Your primary responsibility is the safe operation of your vehicle. We recommend against the use of any hand-held device while driving and encourage the use of voice-operated systems when possible. Make sure you are aware of all applicable local laws that may affect the use of electronic devices while driving.

The first thing you must do to use the phone features of SYNC is to pair your Bluetooth-enabled cell phone with SYNC. This allows you to use your cell phone in a hands-free manner.

**Note:** *This is a speed-dependent feature. It is unavailable when your vehicle is traveling at speeds over 3 mph (5 km/h).*

## Touch the upper left corner of the touchscreen:

| Message     | Action and Description  |
|-------------|---|
| Add a phone |   |
| Find SYNC   | Follow the on-screen instructions. Make sure that Bluetooth is set to <b>On</b> and that your cell phone is in the correct mode. See your cell phone's manual if necessary. Select <b>SYNC</b> and a six-digit PIN appears on your device. If you are prompted to enter a PIN on your device, it does not support Secure Simple Pairing. To pair, enter the PIN displayed on the touchscreen. Skip the next step. When prompted on your cell phone's display, confirm that the PIN provided by SYNC matches the PIN displayed on your cell phone. The display indicates when the pairing is successful. SYNC may prompt you with more cell phone options. For more information on your cell phone's capability, see your cell phone's manual and visit the website. |

## Pairing Subsequent Cell Phones

**Note:** *This is a speed-dependent feature. It is unavailable when your vehicle is traveling at speeds over 3 mph (5 km/h).*

Make sure that Bluetooth is set to **On** and that your cell phone is in the correct mode. See your device's manual if necessary.

# MyFord Touch™ (If Equipped)

## To pair a subsequent cell phone, select:

| Menu Item         | Action and Description  |
|-------------------|---|
| Phone             |   |
| Settings          |   |
| Bluetooth Devices |   |
| Add Device        |   |
| Find SYNC         | Follow the on-screen instructions. Make sure that Bluetooth is set to <b>On</b> and that your cell phone is in the correct mode. See your cell phone's manual if necessary. Select <b>SYNC</b> and a six-digit PIN appears on your device. If you are prompted to enter a PIN on your device, it does not support Secure Simple Pairing. To pair, enter the PIN displayed on the touchscreen. Skip the next step. When prompted on your cell phone's display, confirm that the PIN provided by SYNC matches the PIN displayed on your cell phone. The display indicates when the pairing is successful. SYNC may prompt you with more cell phone options. For more information on your cell phone's capability, see your cell phone's manual and visit the website. |

## Making Calls



**Press the voice button and say a command similar to the following:**

| Voice command |
|---------------|
| Call          |
| Dial          |

You can say the name of a person from your phone book to call or a say a number to dial. For example "Call John" or "Dial 867-5309".



To end the call or exit phone mode, press and hold the phone button.

## Receiving Calls

During an incoming call, an audible tone sounds. Call information appears in the display if it is available.

# MyFord Touch™ (if Equipped)



## To accept the call, select:

| Message |
|---------|
| Accept  |

**Note:** You can also accept the call by pressing the phone button on the steering wheel.



## To reject the call, select:

| Message |
|---------|
| Reject  |

**Note:** You can also reject the call by pressing the phone button on the steering wheel.

Ignore the call by doing nothing. SYNC logs it as a missed call.

## Phone Menu Options

Press the top left corner on the touchscreen to select from the following options:

| Menu Item  | Action and Description  |
|------------|---|
| Phone      | Touch this button to access the on-screen numerical pad to enter a number and place a call. During an active call, you can also choose any of these options:                            |
|            | Mute Call   |
|            | Hold Call   |
|            | Privacy   |
|            | Join Calls  |
|            | End   |
| Quick Dial | Select to call stored contacts.   |
| Phonebook  | Touch this button to access and call any contacts in your previously downloaded phonebook. The system places the entries in alphabetical categories summarized at the top of the screen |
|            | To turn on contact picture settings, if your device supports this feature, select:  |
|            | Phone   |
|            | Settings  |

## MyFord Touch™ (If Equipped)

| Menu Item    | Action and Description  |           |            |
|--------------|---|-----------|------------|
|              | Manage Phonebook  |           |            |
|              | Display Photos from Phonebook   |           |            |
|              | Certain smartphones may support transferring street addresses when listed with phonebook contact information. If your cell phone supports this feature, you can select and use these addresses as destinations and save them as favorites.  |           |            |
| Call History | <p><b>Note:</b> This is a cell phone-dependent feature. If your cell phone does not support downloading call history using Bluetooth, SYNC keeps track of calls made with the SYNC system. After you connect your Bluetooth-enabled cell phone to SYNC, you can access any previously dialed, received or missed calls. You can also choose to save these to:</p> <table border="1"> <tr> <td>Favorites</td> <td>Quick Dial</td> </tr> </table> | Favorites | Quick Dial |
| Favorites    | Quick Dial  |           |            |
| Messaging    | Send text messages using the touchscreen. See <b>Text Messaging</b> later in this section.  |           |            |
| Settings     | Touch this button to access various phone settings, for example turning Bluetooth on and off, managing your phonebook and more. See <b>Phone Settings</b> later in this section   |           |            |

### Text Messaging

**Note:** Downloading and sending text messages using Bluetooth are cell phone-dependent features.

**Note:** Certain features in text messaging are speed-dependent and not available when your vehicle is traveling at speeds over 3 mph (5 km/h).

**Note:** SYNC does not download read text messages from your cell phone.

You can send and receive text messages using Bluetooth, read them aloud and translate text messaging acronyms, for example LOL.

**Touch the top left corner of the display, then select:**

| Message                           |
|-----------------------------------|
| Phone                             |
| Messaging                         |
| <b>Then any of the following:</b> |
| Listen (speaker icon)             |
| Dial                              |
| Send Text                         |
| View                              |
| Delete                            |

# MyFord Touch™ (if Equipped)

## Composing a Text Message

**Note:** This is a speed-dependent feature. It is unavailable when your vehicle is traveling at speeds over 3 mph (5 km/h).

**Note:** Downloading and sending text messages using Bluetooth are cell phone-dependent features.

### To compose and send a text message, select:

| Message   | Action and Description   |
|-----------|--|
| Phone     |  |
| Messaging |  |
| Send Text | Enter a cell phone number or choose from your phonebook.                         |
| Edit Text | Allows you to customize the pre-defined message or create a message on your own. |
| Send      | Sends the message as it is.  |

You can then preview the message, verify the recipient as well as update the message list.

### Text Message Options

| Message  |
|--|
| I'll call you back in a few minutes.           |
| I just left, I'll be there soon.               |
| Can you give me a call?                        |
| I'm on my way.                                 |
| I'm running a few minutes late.                |
| I'm ahead of schedule, so I'll be there early. |
| I'm outside.                                   |
| I'll call you when I get there.                |
| OK   |
| Yes  |
| No   |
| Thanks   |

| Message           |
|-------------------|
| Stuck in traffic. |
| Call me later.    |
| LOL               |

### Receiving a Text Message

**Note:** If you select View and your vehicle is traveling over 3 mph (5 km/h), the system offers to read the message to you instead of allowing you to view it while driving.

**When a new message arrives, an audible tone sounds and the screen displays a pop-up with the caller name and ID, if supported by your cell phone. You can select:**

| Message | Action and Description               |
|---------|--------------------------------------|
| View    | To view the text message.            |
| Listen  | For SYNC to read the message to you. |
| Dial    | To call the contact.                 |
| Ignore  | To exit the screen.                  |

# MyFord Touch™ (If Equipped)

## Phone Settings

To enter the phone settings menu select:

| Message                           | Action and Description  |
|-----------------------------------|---|
| Phone                             |   |
| Settings                          |   |
| <b>Then any of the following:</b> |   |
| Bluetooth Devices                 | Connect, disconnect, add or delete a device, as well as save it as a favorite.  |
| Bluetooth                         | To turn Bluetooth off or on.  |
| Do Not Disturb                    | If you want all calls to go directly to your voicemail and not ring in the vehicle. When this feature is on, text message notifications do not ring inside the cabin either.  |
| 911 Assist                        | Turn the 911 Assist feature on and off. See <b>Information</b> (page 450).  |
| Phone Ringer                      | Select the ring tone you want to hear when you receive a call. Choose from possible system ring tones, your currently paired cell phone's ring tone, a beep, text-to-speech or a silent notification.   |
| Text Message Notification         | Select a text message notification, if supported by your cell phone. Choose from possible system alert tones, text-to-speech or silent.   |
| Internet Data Connection          | If your cell phone is compatible, use this screen to adjust your internet data connection. Select to make your connection profile with the personal area network or to turn off your connection. You can also choose to adjust your settings or have the system always connect, never connect when roaming or query on connect. Press ? for more information. |
| Manage Phonebook                  | To access features such as automatic phonebook download, re-download your phonebook, add contacts from your cell phone as well as delete or upload your phonebook.  |
| Roaming Warning                   | To have the system alert you when your cell phone is in roaming mode.   |

# MyFord Touch™ (If Equipped)

## Phone Voice Commands



Press the voice button and when prompted say any of the following or a similar command:

| Voice command     |
|-------------------|
| Call Voicemail    |
| Listen to Message |
| Reply to Message  |
| Pair Phone        |
| Help              |

## INFORMATION



E188418

| Item | Message     |
|------|-------------|
| A    | Services    |
| B    | Travel Link |
| C    | Alerts      |
| D    | Calendar    |
| E    | Apps        |
| F    | Where Am I? |

 If your vehicle is equipped with Navigation, press the **Information** button to access these features. If your vehicle is not equipped with Navigation, press the corner of the touchscreen with the green tab.



### **SYNC Services (If Equipped, United States Only)**

**Note:** SYNC Services varies by trim level and model year and may require a subscription. Traffic alerts and turn-by-turn directions available in select markets. Message and data rates may apply. Ford Motor Company reserves the right to change or discontinue this product service at any time without prior notification or incurring any future obligation.

**Note:** SYNC Services requires activation before use. Visit [www.SYNCMyRide.com](http://www.SYNCMyRide.com) to register and check your eligibility for complimentary services. Standard phone and message rates may apply. Subscription may be required. You must also have the active SYNC Services Bluetooth-enabled cellular phone paired and connected to the system in order to connect to, and use, SYNC Services. See **Phone** (page 443).

**Note:** This feature does not function properly if you have enabled caller ID blocking on your cellular phone. Make sure your cellular phone is not blocking caller ID before using SYNC Services.

**Note:** The driver is ultimately responsible for the safe operation of the vehicle, and therefore, must evaluate whether it is safe to follow the suggested directions. Any navigation features provided are only an aid. Make your driving decisions based on your observations of local conditions and existing traffic regulations. Do not follow the route suggestions if doing so would result in an unsafe or illegal maneuver, if you would be placed in an unsafe situation, or if you would be directed into an area that you consider unsafe. Maps used by this system may be inaccurate because of errors, changes in roads, traffic conditions or driving conditions.

**Note:** When you connect, the service uses GPS technology and advanced vehicle sensors to collect your vehicle's current location, travel direction and speed to help provide you with the directions, traffic reports, or business searches you request. Further, to provide the services you request, for continuous improvement, the service may collect and record call details and voice communications. For more information, see SYNC Services Terms and Conditions at [www.SYNCMyRide.com](http://www.SYNCMyRide.com). If you do not want Ford or its service providers to collect your vehicle travel information or other information identified in the Terms and Conditions, do not subscribe or use the service.

SYNC Services uses advanced vehicle sensors, integrated GPS technology and comprehensive map and traffic data, to give you personalized traffic reports, precise turn-by-turn directions, business search, news, sports, weather and more. For a complete list of services, or to learn more, please visit [www.SYNCMyRide.com](http://www.SYNCMyRide.com).

### **Connecting to SYNC Services**

You can connect to SYNC Services using voice commands or by selecting a menu item on the touchscreen.

## MyFord Touch™ (If Equipped)

**To use voice commands, press the voice button and say:**

| Voice Command  | Action and Description  |
|--|---|
| Services   | This initiates an outgoing call to SYNC Services using your paired and connected Bluetooth-enabled cellular phone. Once you connect to the service, follow the voice prompts to request the desired service, for example traffic or directions. |
| Once connected to SYNC Services, you can also say the following: |   |
| What Can I Say   | Receive a list of available services from which to choose.  |
| Services   | To return to the Services main menu.  |
| Help   | Receive system help.  |

If your vehicle is equipped with Navigation, press the **I (Information)** button. If your vehicle is not equipped with Navigation, press the green tab on your touchscreen.

**To use the touchscreen select:**

| Menu Item           |
|---------------------|
| Connect to Services |

This command initiates an outgoing call to SYNC Services using your paired and connected Bluetooth-enabled cellular phone. Once you connect to the service, follow the voice prompts to request the desired service.

## MyFord Touch™ (If Equipped)

### Receiving Turn-by-Turn Directions

Press the voice button and say:

| Voice Command                | Action and Description   |
|------------------------------|--|
| Directions                   | To receive directions to a location. Once you select your destination, the system uploads your current vehicle location, calculates a route based on current traffic conditions and sends it back to your vehicle. After the route download is complete, the phone call automatically ends. You then receive audible and visual driving instructions as you travel toward your destination.  |
| Business Search              | To find a business or type of business. Once you select your destination, the system uploads your current vehicle location, calculates a route based on current traffic conditions and sends it back to your vehicle. After the route download is complete, the phone call automatically ends. You then receive audible and visual driving instructions as you travel toward your destination.   |
| Search near me               | To find the closest business or type of business to your location, within business search.   |
| Operator                     | Provides you with further assistance within Directions and Business Search. The system may prompt you to speak with an operator when it has difficulty matching your voice request. The live operator can assist you by searching for businesses by name or by category, residential addresses by street address or by name or specific street intersections. Operator Assist is a feature of your SYNC Services subscription. For more information on Operator Assist, visit <a href="http://www.SYNCMyRide.com/support">www.SYNCMyRide.com/support</a> . |
| Yes [During an active route] | If you miss a turn, SYNC automatically asks if you want the route updated. Say yes when prompted and the system sends a new route to your vehicle.   |

# MyFord Touch™ (If Equipped)

## Disconnecting from SYNC Services

To use the steering wheel controls, press and hold the hang-up phone button on the steering wheel.

**To use voice commands, press the voice button and say:**

| Voice Command |
|---------------|
| Good-bye      |

## SYNC Services Quick Tips

| Tips              |  |
|-------------------|--|
| Personalizing     | You can personalize your Services feature to provide quicker access to your most used or favorite information. You can save address points, such as work or home. You can also save favorite information like sports teams, for example Detroit Lions, or a news category. You can learn more about personalization by logging onto <a href="http://www.SYNCMYride.com">www.SYNCMYride.com</a> . |
| Push to interrupt | Press the voice button at any time (while connected to SYNC Services) to interrupt a voice prompt or an audio clip (such as a sports report) and say your voice command.   |
| Portable          | Your subscription is associated with your Bluetooth-enabled cellular phone number, not your VIN (Vehicle Identification Number). You can pair and connect your phone to any vehicle equipped with SYNC Services and continue enjoying your personalized services.  |

## SYNC Services Voice Commands



If your vehicle is equipped with Navigation, SYNC Services downloads your requested destination to the navigation system. The navigation system then calculates the route and provides driving instructions. See **Navigation** (page 464).

If your vehicle is not equipped with Navigation, when a route has been downloaded (non-navigation systems), you can press the voice button on the steering wheel controls and say any of the following commands to receive directions:

## Services

| Voice command |
|---------------|
| Cancel Route  |
| Route Status  |
| Route Summary |
| Update Route  |
| Help          |

# MyFord Touch™ (If Equipped)

## Sirius Travel Link (If Equipped)

### WARNING



Driving while distracted can result in loss of vehicle control, crash and injury. We strongly recommend that you use extreme caution when using any device that may take your focus off the road. Your primary responsibility is the safe operation of your vehicle. We recommend against the use of any handheld device while driving and encourage the use of voice-operated systems when possible. Make sure you are aware of all applicable local laws that may affect the use of electronic devices while driving.

**Note:** In order to use Sirius Travel Link, your vehicle must be equipped with navigation and your navigation SD card must be in the SD card slot.

**Note:** A paid subscription is required to access and use these features. Go to [www.siriusxm.com/travellink](http://www.siriusxm.com/travellink) for more information.

**Note:** Visit [www.siriusxm.com/traffic](http://www.siriusxm.com/traffic) and click on Coverage map and details for a complete listing of all traffic areas covered by Sirius Travel Link.

**Note:** Neither Sirius nor Ford is responsible for any errors or inaccuracies in the Sirius Travel Link services or its use in vehicles.

When you subscribe to Sirius Travel Link, it can help you locate the best gas prices, find movie listings, get current traffic alerts, view the current weather map, get accurate ski conditions and see scores to current sports games.

| Menu Item        | Action and Description  |
|------------------|---|
| Traffic on Route | Touch these buttons to identify traffic incidents on your route, nearby your vehicle's current location or near any of your favorite places, if programmed. |
| Traffic Nearby   |   |
| Fuel Prices      | Touch this button to view fuel prices at stations close to your vehicle's location or on an active navigation route.  |
| Movie Listings   | Touch this button to view nearby movie theaters and their show times, if available.   |
| Weather          | Touch this button to view the nearby weather, current weather, or the five day forecast for the chosen area.  |
|                  | Map   |

## MyFord Touch™ (If Equipped)

| Menu Item      | Action and Description  |   |
|----------------|---|---|
|                | Area  | Select to choose from a listing of weather locations. |
| Sports Info    | Touch this button to view scores and schedules from a variety of sports. You can also save up to 10 favorite teams for easier access. The score automatically refreshes when a game is in progress. |   |
| Ski Conditions | Touch this button to view ski conditions for a specific area.   |   |

### Sirius Travel Link Voice Commands



**Press the voice button on the steering wheel controls. When prompted, say any of the following or a similar command:**

| Voice command |
|---------------|
| Show Traffic  |
| Show Weather  |
| Help          |

### Alerts



If your vehicle is equipped with Navigation, touch the I (Information) button to access these features. If your vehicle is not equipped with Navigation, touch the corner of the touchscreen with the green tab.

### Press Alerts, then choose from any of the following services:

| Message    | Action and Description |
|------------|------------------------|
| View       | The complete message   |
| Delete     | The message            |
| Delete All | Messages               |

This screen displays any system messages (such as an SD card fault).

**Note:** *The system alerts you to any messages by turning the information icon yellow. After you read or delete the messages, the icon returns to white.*

### Calendar



If your vehicle is equipped with Navigation, touch the I (Information) button to access these features. If your vehicle is not equipped with Navigation, touch the corner of the touchscreen with the green tab.

Press **Calendar**. You can view the current calendar by day, week or month.

# MyFord Touch™ (If Equipped)

## 911 Assist

### WARNINGS



Unless the 911 Assist setting is set on before a crash, the system will not dial for help, which could delay response time, potentially increasing the risk of serious injury or death after a crash.



Do not wait for 911 Assist to make an emergency call if you can do it yourself. Dial emergency services immediately to avoid delayed response time, which could increase the risk of serious injury or death after a crash. If you do not hear 911 Assist within five seconds of the crash, the system or phone may be damaged or non-functional.



Always place your phone in a secure location in your vehicle so it does not become a projectile or damaged in a crash. Failure to do so may cause serious injury to someone or damage the phone, which could prevent 911 Assist from working properly.

**Note:** *The SYNC 911 Assist feature must be set on prior to the incident.*

**Note:** *Before setting this feature on, make sure that you read the 911 Assist Privacy Notice later in this section for important information.*

**Note:** *If any user turns 911 Assist on or off, that setting applies for all paired phones. If 911 Assist is turned off, either a voice message plays or a display message (or icon) comes on (or both) when your vehicle is started after a previously paired phone connects.*

**Note:** *Every phone operates differently. While SYNC 911 Assist works with most cellular phones, some may have trouble using this feature.*

If a crash deploys an airbag, excluding knee airbags and rear inflatable safety belts where fitted or activates the fuel pump shut-off, your SYNC-equipped vehicle may be able to contact emergency services by dialing 911 through a paired and connected Bluetooth-enabled phone. For more information about the 911 Assist feature visit:

### Website

visit [www.SYNCMYride.com](http://www.SYNCMYride.com)  
[www.SYNCMYride.ca](http://www.SYNCMYride.ca)  
[www.syncmaroute.ca](http://www.syncmaroute.ca)

See **Supplementary Restraints System** (page 40). Important information regarding airbag deployment is in this chapter.

See **Roadside Emergencies** (page 251). Important information regarding the fuel pump shut-off is in this chapter.

### Setting 911 Assist On

**If your vehicle is equipped with Navigation, touch the I (Information) button to access these features. If your vehicle is not equipped with Navigation, touch the corner of the touchscreen with the green tab. Then select:**

| Message    |
|------------|
| Apps       |
| 911 Assist |
| On         |

## You can also access 911 Assist by pressing:

| Message                        |
|--------------------------------|
| Settings                       |
| Phone                          |
| 911 Assist                     |
| <b>Or you can also select:</b> |
| Help                           |
| 911 Assist                     |

To make sure that 911 Assist works properly:

- SYNC must be powered and working properly at the time of the incident and throughout feature activation and use.
- The 911 Assist feature must be set on prior to the incident.
- You must pair and connect a Bluetooth-enabled and compatible phone to SYNC.
- A connected Bluetooth-enabled phone must have the ability to make and maintain an outgoing call at the time of the incident.
- A connected Bluetooth-enabled phone must have adequate network coverage, battery power and signal strength.
- The vehicle must have battery power and be located in the United States, Canada or in a territory in which 911 is the emergency number.

## In the Event of a Crash

Not all crashes deploy an airbag or activate the fuel pump shut-off (which would trigger 911 Assist); however, SYNC tries to contact emergency services if 911 Assist triggers. If a connected phone sustains damage or loses connection to SYNC, SYNC searches for, and tries to connect to, any available previously paired phone and tries to make the call to 911.

Before making the call:

- SYNC provides a short window of time (approximately 10 seconds) to cancel the call. If you fail to cancel the call, SYNC attempts to dial 911.
- SYNC says the following, or a similar message: "SYNC will attempt to call 911, to cancel the call, press Cancel on your screen or press and hold the phone button on your steering wheel."

If you do not cancel the call, and SYNC makes a successful call, a pre-recorded message plays for the 911 operator, and then the occupant(s) in your vehicle is able to talk with the operator. Be prepared to provide your name, phone number and location immediately, because not all 911 systems are capable of receiving this information electronically.

## 911 Assist May Not Work If:

- Your cellular phone or 911 Assist hardware sustains damage in a crash.
- The vehicle's battery or the SYNC system has no power.
- The phone(s) previously paired or connected to the system are thrown from the vehicle.



## 911 Assist Privacy Notice

When you turn on 911 Assist, it may disclose to emergency services that your vehicle has been in a crash involving the deployment of an airbag or activation of the fuel pump shut-off. Certain versions or updates to 911 Assist may also be capable of electronically or verbally disclosing to 911 operators your vehicle location or other details about your vehicle or crash to assist 911 operators to provide the most appropriate emergency services. If you do not want to disclose this information, do not turn the feature on.

## Vehicle Health Report (If Equipped, US Only)

### WARNING



Always follow scheduled maintenance instructions, regularly inspect your vehicle, and seek repair for any damage or problem you suspect. Vehicle Health Report supplements, but cannot replace, normal maintenance and vehicle inspection. Vehicle Health Report only monitors certain systems electronically monitored by your vehicle and will not monitor or report the status of any other system, (such as brake lining wear). Failure to perform scheduled maintenance and regularly inspect your vehicle may result in vehicle damage and serious injury.

**Note:** Your Vehicle Health Report feature requires activation prior to use. Visit [www.SYNCMYRide.com](http://www.SYNCMYRide.com) to register. There is no fee or subscription associated with Vehicle Health Report, but you must register to use this feature.

**Note:** This feature may not function properly if you have enabled caller ID blocking on your cellular phone. Before running a report, review the Vehicle Health Report Privacy Notice.

**Note:** In order to allow a break-in period for your vehicle, you may not be able to create a Vehicle Health Report until your vehicle odometer has reached 200 miles.

**Note:** Cellular phone and SMS charges may apply when making a report.

Register for Vehicle Health Report and set your report preferences at [www.SYNCMYRide.com](http://www.SYNCMYRide.com). After registering, you can request a Vehicle Health Report (inside your vehicle). Return to your account at [www.SYNCMYRide.com](http://www.SYNCMYRide.com) to view your report. You can also choose for SYNC to remind you automatically to run reports at specific mileage intervals. Cellular phone airtime usage may apply when reporting.

The system allows you to check your vehicle's overall health in the form of a diagnostic report card. The Vehicle Health Report contains valuable information, for example:

- Vehicle diagnostic information.
- Scheduled maintenance.
- Open recalls and Field Service Actions.
- Items noted during vehicle inspections by your authorized dealer that still need servicing.

## Making a Report

**If you want to run a report by using the touchscreen, select:**

| Message               |
|-----------------------|
| Apps                  |
| Vehicle Health Report |



You can also run a vehicle health report by voice command.

# MyFord Touch™ (If Equipped)

**Press the voice button and when prompted say:**

| Voice command         |
|-----------------------|
| Vehicle Health Report |

## Vehicle Health Report Privacy Notice

When you create a Vehicle Health Report, Ford Motor Company may collect your cellular phone number (to process your report request) and diagnostic information about your vehicle. Certain versions or updates to Vehicle Health Report may also collect more vehicle information. Ford may use your vehicle information it collects for any purpose. If you do not want to disclose your cellular phone number or vehicle information, do not run the feature or set up your Vehicle Health Report profile at [www.SYNCMyRide.com](http://www.SYNCMyRide.com). See [www.SYNCMyRide.com](http://www.SYNCMyRide.com) (Vehicle Health Report Terms and Conditions, and Privacy Statement) for more information.

## Where Am I?

**For information about your current location, select:**

| Message     | Action and Description  |
|-------------|---|
| Where Am I? | View your vehicle's current location, if your vehicle is equipped with navigation. If your vehicle is not equipped with navigation, nothing displays. |

## CLIMATE

Touch the lower right corner on the touchscreen to access your climate control features. Depending on your vehicle line and option package, your climate screen may look different from this screen.

**Note:** You can switch temperature units between Fahrenheit and Celsius. See **Settings** (page 414).

## MyFord Touch™ (If Equipped)

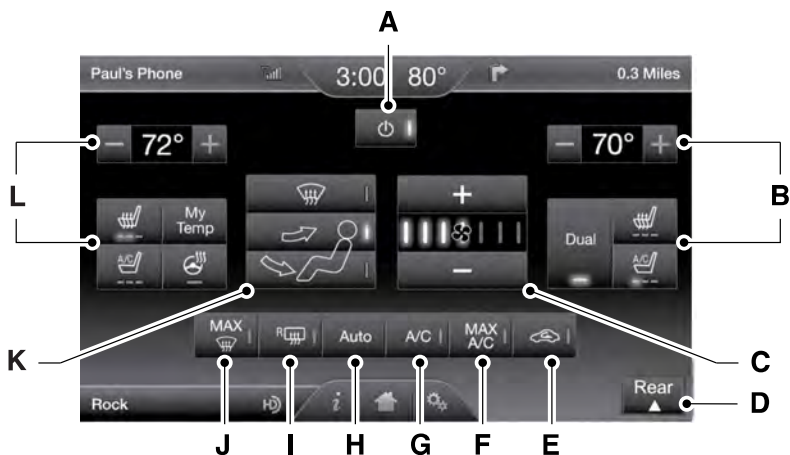

E200641

- A Power:** Touch the button to switch the system on and off. Switching off the climate control system prevents outside air from entering the vehicle.
- B Passenger settings:**
- Touch the **+** or **-** to increase or decrease the air temperature on the passenger side of the vehicle.
  - Touch the heated seat icon to switch the heated seat off and on (if equipped).
  - Touch the climate-controlled seat icon to switch the climate-controlled seat off and on (if equipped).
  - Touch **Dual** to switch separate passenger side temperature controls off and on. When you switch off **Dual**, the passenger side temperature changes to match the driver side temperature.
- Note:** The passenger side temperature and the **Dual** indicator automatically turn on when the passenger is adjusting their temperature control.
- C Fan speed:** Touch **+** or **-** to increase or decrease the volume of air circulated in your vehicle.
- Note:** When the system is controlling the fan speed automatically, all the fan speed indicators turn off.
- D Rear:** Touch to access the rear climate control. Rear climate control settings appear at the bottom of the screen.
- Touch the power icon to turn the rear climate control functions off and on.

## MyFord Touch™ (If Equipped)

---

Touch **Rear** to allow the rear seat passengers to adjust the rear climate settings. Touch it again to prevent the rear seat passengers from adjusting the settings. Rear Control automatically turns off when you use the touchscreen to adjust the rear climate settings.

Touch + or – to adjust the temperature.

To adjust fan speed, touch + or – next to the fan icon.

Touch **Rear** again to close the rear controls. Closing the rear climate control functions does not affect their current settings.

- E **Recirculated air:** Touch the button to switch between outside air and recirculated air. When you select recirculated air, the air currently in the passenger compartment recirculates. This may reduce the time needed to cool the interior (when used with **A/C**) and may reduce unwanted odors from entering your vehicle.  
**Note:** Recirculated air may turn off automatically (or be prevented from turning on) in all airflow modes except **Max A/C** to reduce risk of fogging. Recirculated air may also turn on and off automatically in **Panel** or **Panel and Floor** airflow modes during hot weather in order to improve cooling efficiency.
- F **Max A/C:** Touch the button to maximize cooling. Recirculated air flows through the instrument panel vents, air conditioning automatically turns on, and the fan automatically adjusts to the highest speed.
- G **A/C:** Touch the button to switch air conditioning compressor on or off. Use air conditioning with recirculated air to improve cooling performance and efficiency.  
**Note:** In certain conditions (such as when using Max Defrost), the air conditioning compressor may continue to operate even after you switch off the air conditioning with the **A/C** button.
- H **Auto:** Touch the button to switch on automatic operation. Select the desired temperature using the temperature control. The system adjusts fan speed, air distribution, air conditioning operation, and selects outside air or recirculated air to heat or cool the vehicle in order to maintain the desired temperature. You can also use the **Auto** button to switch off dual zone operation by touching and holding the button for more than two seconds.
- I **Heated rear window:** Turns the heated rear window on and off. See **Heated Windows and Mirrors** (page 135).
- J **Max Defrost:** Touch the button to maximize defrosting. Outside air flows through the windshield vents, fan automatically adjusts to the highest speed and the temperature dial returns to the full heat position. You can use this setting to defog or clear a thin covering of ice from the windshield. The heated rear window also automatically turns on when you select Max Defrost.
- K **Air distribution control:** Touch these buttons to switch airflow from the windshield, instrument panel, or footwell vents on or off. The system can distribute air through the following combinations: windshield, windshield/floor, panel, panel/floor, and floor.

# MyFord Touch™ (If Equipped)

**Note:** To prevent window fogging, you cannot select recirculated air when MAX Defrost is on.

## L **Driver settings:**

Touch the **+** or **-** to increase or decrease the air temperature on the driver side of the vehicle.

Touch the heated seat icon to switch the heated seat off and on (if equipped).

Touch the climate-controlled seat icon to switch the climate-controlled seat off and on (if equipped).

Touch **MyTemp** to select your preset temperature setpoint. Touch and hold **MyTemp** to save a new preset temperature setpoint.

Touch the heated steering wheel icon to switch the heated steering wheel on and off (if equipped).

**Note:** If your vehicle is equipped with a wood-trimmed steering wheel, it does not heat between the 10 o'clock and 2 o'clock positions.

## **Climate Control Voice Commands**

**Note:** Depending on the current climate control settings, the fan speed may automatically go down while issuing voice commands or while making and receiving phone calls via SYNC to reduce the amount of background noise in the vehicle. The fan speed automatically returns to normal operation once the voice session ends. You can adjust fan speed normally during a voice session by pressing the fan buttons (or turning the fan knob) to increase or decrease the fan speed to the desired setting.

To disable this automatic fan speed reduction feature during voice sessions, press and hold the climate control **AC** and **Recirc** buttons simultaneously, release and then increase fan speed within 2 seconds. To re-enable this feature, repeat this sequence.



Press the voice button on the steering wheel controls. When prompted, say any of the following or a similar command:

| <b>Voice commands</b> |   |
|-----------------------|---|
| Climate On            |   |
| Climate Off           |   |
| Set temperature       | Adjust the temperature to between 15.0 - 30.0°C or 59 - 86°F. |

# MyFord Touch™ (If Equipped)

## NAVIGATION

**Note:** The navigation SD card must be in the SD card slot to operate the navigation system. If you need a replacement SD card, see an authorized dealer.

**Note:** The SD card slot is spring-loaded. To remove the SD card, just push the card in and release it. Do not attempt to pull the card out to remove it; this could cause damage.

Your navigation system is comprised of two main features, destination mode and map mode.

### Destination Mode

**To set a destination, press the green corner of your touchscreen, then press:**

| Menu Item                           |
|-------------------------------------|
| Dest.                               |
| <b>Choose any of the following:</b> |
| My Home                             |
| Favorites                           |
| Previous Destinations               |
| Point of Interest                   |
| Emergency                           |

| Menu Item      |
|----------------|
| Street Address |
| Intersection   |
| City Center    |
| Map            |
| Edit Route     |
| Cancel Route   |

To set your destination, enter the necessary information into the highlighted text fields (in any order).

**For an address destination entry, press:**

| Menu Item | Action and Description   |
|-----------|--|
| Go        | Pressing this button makes the address location appear on the map. |

**To choose a previous destination, press:**

| Menu Item             | Action and Description                             |
|-----------------------|--|
| Previous Destinations | The last 20 destinations you have selected appear. |

# MyFord Touch™ (If Equipped)

## Once you have chosen your destination press:

| Menu Item   | Action and Description   |   |
|-------------|--|---|
| Set as Dest | To make this your destination. You can also choose to set this as a waypoint (have the system route to this point on the way to your current destination) or save it as a favorite. You can then choose your route from three different options. |   |
|             | Fastest Route  | Uses the fastest moving roads possible. |
|             | Shortest Route   | Uses the shortest distance possible.    |
|             | Eco Route  | Uses the most fuel-efficient route.     |

## To begin navigation press:

| Menu Item   | Action and Description  |
|-------------|---|
| Start Route | You can cancel the route or have the system demo the route for you.<br>During route guidance, you can press the talking bubble icon that appears in the upper right navigation corner (green bar) if you want the system to repeat route guidance information.<br>When the system repeats the last guidance instruction, it updates the distance to the next guidance instruction, since it detects when the vehicle is moving. |

**Note:** If your vehicle is on a recognized road and you do not press the **Start Route** button, the system defaults to the Fastest Route option and begins guidance.

## Points of Interest (POI) Categories

You can select from a variety of POI categories that display on the screen.

To expand these listings, press the + in front of the listing.

The system also allows you to sort alphabetically or by distance.

## cityseekr

**Note:** cityseekr point of interest (POI) information is limited to approximately 912 cities (881 in the United States, 20 in Canada and 11 in Mexico).



E142634

cityseekr, when available, is a service that provides more information about certain points of interest such as restaurants, hotels and attractions.

When you have selected a point of interest, the location and information appear, such as address and phone number. If cityseekr lists the point of interest, more information is available, such as a brief description, check-in and checkout times or restaurant hours.

**For a longer review, a list of services and facilities, the average room, meal price or the website press:**

| Menu Item        |
|------------------|
| More Information |

This screen displays the point of interest icon such as:



Hotel



Coffeehouse



Food & Drink



Nightlife



Attraction



This icon appears when your selection exists in multiple categories within the system.

**When you are viewing more information for hotels, cityseekr also tells you if the hotel has certain services and facilities using icons, such as:**

- Restaurant
- Business center
- Handicap facilities
- Laundry
- Refrigerator
- 24 hour room service
- Fitness center
- Internet access
- Pool
- Wi-Fi

For restaurants, cityseekr can provide information such as star rating, average cost, review, handicap access, hours of operation, and website address.

For hotels, cityseekr can provide information such as star rating, price category, review, check-in and checkout times, hotel service icons and website address.

## Setting Your Navigation Preferences



Select settings for the system to take into account when planning your route.

**To access the settings options, press**

| Menu Item  |
|------------|
| Settings   |
| Navigation |

You can then select any of the following options.



## MyFord Touch™ (If Equipped)

| Menu Item                                | Second Level Messages, Actions and Descriptions   |               |
|--|---|---------------|
| Map Preferences                          |   |               |
| <b>Then select any of the following:</b> |   |               |
| Breadcrumbs                              | Display your vehicle's previously traveled route with white dots. You can switch this feature:  |               |
|  | On  | Off           |
| Turn List Format                         | Have the system display your turn list  |               |
|  | Top to Bottom   | Bottom to Top |
| Parking POI Notification                 | When parking point of interest notification is on, the icons display on the map when you get close to your destination. This may not be very useful in dense areas, and may clutter the map when other points of interest display. Set the automatic parking point of interest notification. You can switch this feature: |               |
|  | On  | Off           |

| Menu Item                                | Second Level Messages, Actions and Descriptions  |               |            |
|--|--|---------------|------------|
| Route Preferences                        |  |               |            |
| <b>Then select any of the following:</b> |  |               |            |
| Preferred Route                          | Choose to have the system display your chosen route type.  |               |            |
|  | Shortest Route   | Fastest Route | Ecological |
| Always use Preferred Route               | Bypass route selection in destination programming. The system only calculates one route based on preferred route setting. When activated, the system uses your selected route type to calculate only one route to the desired destination. |               |            |
| Eco Time Penalty                         | Select a level of cost for the calculated Eco Route. The higher the setting, the longer the time allotment is for the route.   |               |            |
| Avoid                                    | When activated, you can to choose to have the system avoid highways, toll roads, ferries, and car trains when planning your route.   |               |            |
| Use HOV Lanes                            | Have the system use high-occupancy vehicle lanes, if available, when planning your route.  |               |            |

## MyFord Touch™ (If Equipped)

| Menu Item                                | Second Level Messages, Actions and Descriptions   |                 |
|--|---|-----------------|
| Navigation Preferences                   |   |                 |
| <b>Then select any of the following:</b> |   |                 |
| Guidance Prompts                         | Select the type of prompts the system uses.   |                 |
|  | Tones Only  | Voice and Tones |
| Auto - Fill State/Province               | Have the system automatically fill in this information based on what you have already entered into the system. You can switch this feature: |                 |
|  | On  | Off             |

| Menu Item  | Second Level Messages, Actions and Descriptions  |  |
|--|--|--|
| Traffic Preferences  |  |  |
| <b>Then select any of the following:</b>                         |  |  |
| Avoid Traffic Problems   | You can choose how you want the system to handle traffic problems along your route.                                |  |
|  | Automatic  | Have the system reroute you to avoid traffic incidents that develop and impact the current route. The system does not provide a traffic alert notification   |
|  | Manual   | Have the system always provide a traffic alert notification for traffic incidents along the planned route. You have a choice to accept or ignore the notification before making the route deviation. |
| Traffic alert notification                                       | Activate traffic alert notifications on or off.  |  |
| You are also able to switch on and off the 11 traffic map icons. | These icons will alert you to traffic and driving conditions including accidents, closures and weather conditions. |  |

## MyFord Touch™ (If Equipped)

| Menu Item                                | Second Level Messages, Actions and Descriptions  |
|--|--|
| Avoid Areas                              | Choose areas which you want the system to avoid when calculating a route for you   |
| <b>Then select any of the following:</b> |  |
| Add                                      | Once you make a selection, the system tries to avoid the area(s) if possible for all routes. Select this button to program an entry, then choose a destination entry method. You can edit the name or location of a destination or remove it from your selections. |
| Delete                                   | To remove an area from your selection, choose the listing on the screen. The screen will change, then press delete and confirm the deletion.   |

### Map Mode

Press the green bar in the upper right area of the touchscreen to view map mode. Map mode shows advanced viewing comprised of both 2D city maps as well as 3D landmarks (when available).

2D city maps show detailed outlines of buildings, visible land use and land elements and detailed railway infrastructure for the most essential cities around the globe. These maps also contain features, such as town blocks, building footprints and railways.

3D landmarks appear as clear, visible objects that are typically recognizable and have a certain tourist value. The 3D landmarks appear in 3D map mode only. Coverage varies and improves with updated map releases.



E174016

Change the appearance of the map display by repeatedly pressing the arrow button in the upper left corner of the screen. It toggles between three different map modes: Heading up, North up and 3D.



**Heading up (2D map)** always shows the direction of forward travel to be upward on the screen. This view is available for map scales up to 2.5 miles (4 kilometers). The system remembers this setting for larger map scales, but shows the map in North up only. If the scale returns below this level, the system restores Heading up.

# MyFord Touch™ (If Equipped)



**North up (2D map)** always shows the northern direction to be upward on the screen.



**3D map mode** provides an elevated perspective of the map. This viewing angle can be adjusted and the map can be rotated 180 degrees by touching

the map twice, and then dragging your finger along the shaded bar with arrows at the bottom of the map.

## You can also select the following options:

| Menu Items | Description   |
|------------|---|
| View       | Switches between full map, street list and exit view in route guidance. |
| Menu       | Displays a pop-up box that allows direct access to navigation settings. |



Press the speaker button on the map to mute route guidance. When the light on the button illuminates, the feature is on. The speaker button appears on the map only when route guidance is active.



Re-center the map by pressing this icon whenever you scroll the map away from your vehicle's current location.

## Auto Zoom

Press the green bar to access map mode, then select the **+** or **-** zoom button to bring up the zoom level and Auto buttons on the touchscreen. When you press **Auto**, Auto Zoom turns on and **Auto** displays in the bottom left corner of the screen in the map

scale. The map zoom level then synchronizes with vehicle speed. The slower your vehicle is traveling, the farther the map zooms in; the faster your vehicle is traveling, the farther the map zooms out. To switch off the feature, just press the **+** or **-** button again.

In 3D mode, rotate the map view by swiping your finger across the shaded bar with the arrows.

The ETA box under the zoom buttons appears when a route is active and displays the distance and time to your destination. If the button is pressed, a pop up appears with the destination listed (and waypoint if applicable) along with mileage and time to destination. You may also select to have either the estimated time to reach your destination or your estimated arrival time.

## Map Icons



**Vehicle mark** shows the current location of your vehicle. It stays in the center of the map display, except when in scroll mode.



**Scroll cursor** allows you to scroll the map; the fixed icon is in the center of the screen. The map position closest to the cursor is in a window on the top center part of the screen.



**Address book entry default icon(s)** indicates the location on the map of an address book entry. This is the default symbol shown after the entry has been stored to the Address Book by any method other than the map. You can select from any of the 22 icons available. You can use each icon more than once.

# MyFord Touch™ (If Equipped)



**Home** indicates the location on the map currently stored as the home position. You can only save one address from the Address Book as your Home entry. You cannot change this icon.



**POI (Point Of Interest) icons** indicate locations of any point of interest categories you choose to display on the map. You can choose to display three point of interest categories on the map at one time.



**Starting point** indicates the starting point of a planned route.



**Waypoint** indicates the location of a waypoint on the map. The number inside the circle is different for each waypoint and represents the position of the waypoint in the route list.



**Destination symbol** indicates the ending point of a planned route.



**Next maneuver point** indicates the location of the next turn on the planned route.



**No GPS symbol** indicates that insufficient GPS satellite signals are available for accurate map positioning. This icon may display under normal operation in an area with poor GPS access.

## Quick-touch Buttons

When in map mode, touch anywhere on the map display to access the following options:

| Menu Item         | Action and Description  |    |
|-------------------|---|----|
| Set as Dest       | Touch this button to select a scrolled location on the map as your destination. You may scroll the map by pressing your index finger on the map display. When you reach the desired location, simply let go and then touch this button. |    |
| Set as Waypoint   | Touch this button to set the current location as a waypoint.  |    |
| Save to Favorites | Touch this button to save the current location to your favorites.   |    |
| POI Icons         | Touch this button to select icons to display on the map. You can select up to three icons to display on the map at the same time. You can switch these features:  |    |
|                   | <table border="1"> <tr> <td>On</td> <td>Off</td> </tr> </table>   | On |
| On                | Off   |    |
| View / Edit Route | When on an active route, select any of the following options:   |    |
|                   | View Route  |    |
|                   | Edit Destination/Waypoints  |    |
|                   | Edit Turn List  |    |

## MyFord Touch™ (If Equipped)

| Menu Item | Action and Description   |
|-----------|--------------------------|
|           | Detour                   |
|           | Edit Route Preferences   |
|           | Edit Traffic Preferences |
|           | Cancel Route             |

HERE is the digital map provider for the navigation application. If you find map data errors, you may report them directly to HERE by going to [www.here.com/mapcreator](http://www.here.com/mapcreator). HERE evaluates all reported map errors and responds with the result of their investigation by e-mail.

### Navigation Map Updates

Annual navigation map updates are available for purchase through your dealership, by calling 1-866-462-8837 (in Mexico, call 01-800-557-5539) or going to [www.navigation.com/sync](http://www.navigation.com/sync). You need to specify the make and model of your vehicle to determine if there is an update available.

### Navigation Voice Commands



When in navigation mode, press the voice button on the steering wheel controls.

**After the tone, say any of the following or a similar command:**

| Voice command |
|---------------|
| Destination   |
| Zoom out      |
| Zoom in       |
| Where Am I    |
| Help          |

**The following commands can only be used when a navigation route is active:**

| Voice command      |
|--------------------|
| Detour             |
| Cancel Route       |
| Show Route         |
| Repeat Instruction |
| Turn List          |

### One-shot Destination Street Address

**To set a destination with voice commands, you can say:**

| Voice Command   | Action and Description   |
|-----------------|--|
| Find an Address | The system asks you to say the full address. The system displays an example on-screen. |

You can then speak the address naturally, such as "One two three four Main Street, Anytown".

## MYFORD TOUCH™ TROUBLESHOOTING

Your SYNC system is easy to use. However, should questions arise, see the tables below.

## MyFord Touch™ (If Equipped)

Use the website at any time to check your phone's compatibility, register your account and set preferences as well as access a customer representative via an online chat (during certain hours). For more information visit:

| Websites           |
|--------------------|
| www.SYNCMYride.com |
| www.SYNCMYride.ca  |
| www.syncmaroute.ca |

| Phone issues  |   |   |
|---|---|---|
| Issue   | Possible cause(s)   | Possible solution(s)  |
| There is excessive background noise during a phone call.  | The audio control settings on your phone may be affecting SYNC performance.     | Review your phone's manual about audio adjustments.   |
| During a call, I can hear the other person but they cannot hear me.                                       | This may be a possible phone malfunction.                                       | Try turning off the device, resetting the device, removing the device's battery, then trying again.   |
| SYNC is not able to download my phonebook.  | This is a phone-dependent feature.<br>This may be a possible phone malfunction. | Go to the website to review your phone's compatibility. Try turning off the device, resetting the device or removing the device's battery, then trying again. Try pushing your phonebook contacts to SYNC. See <b>Phone</b> (page 443). Use the SYNCmyphone feature available on the website. |
| The system says that the phonebook has downloaded but the phonebook in SYNC is empty or missing contacts. | This may be a limitation on your phone's capability.                            | Try pushing your phonebook contacts to SYNC. See <b>Phone</b> (page 443). If the missing contacts are stored on your SIM card, try moving them to the device memory. Remove any pictures or special ring tones associated with the missing contact.   |

## MyFord Touch™ (If Equipped)

| <b>Phone issues</b>                              |  |   |
|--|--|---|
| <b>Issue</b>                                     | <b>Possible cause(s)</b>   | <b>Possible solution(s)</b>   |
|  |  | Depending upon your phone, you may have to grant SYNC permission to access your phonebook contacts. Make sure to confirm when prompted by your phone during the phonebook download.   |
| I am having trouble connecting my phone to SYNC. | This is a phone-dependent feature. This may be a possible phone malfunction. | Go to the website to review your phone's compatibility. Try turning off the device, resetting the device or removing the device's battery, then trying again. Try deleting your device from SYNC, deleting SYNC from your device and trying again. Check the security and auto accept and prompt always settings relative to the SYNC Bluetooth connection on your phone. Update your device's firmware. Turn off the Auto phonebook download setting. You can also preform the MyFord Touch reset procedure. |
| Text messaging is not working on SYNC.           | This is a phone-dependent feature. This may be a possible phone malfunction. | Go to the website to review your phone's compatibility. Try turning off the device, resetting the device or removing the device's battery, then trying again.   |



## MyFord Touch™ (If Equipped)

| <b>USB and media issues</b>                               |  |   |
|---|--|---|
| <b>Issue</b>  | <b>Possible cause(s)</b>   | <b>Possible solution(s)</b>   |
| I am having trouble connecting my device.                 | This may be a possible device malfunction.   | Try turning off the device, resetting the device, removing the device's battery, then trying again. Make sure you are using the manufacturer's cable. Make sure you insert the USB cable correctly into the device and the USB port. Make sure that the device does not have an auto-install program or active security settings. |
| SYNC does not recognize my device when I turn on the car. | This is a device limitation.   | Make sure you are not leaving the device in your vehicle during very hot or cold temperatures.  |
| Bluetooth audio does not stream.                          | This is a phone-dependent feature.<br>The device is not connected.   | Review the device compatibility chart on the SYNC website to confirm your phone supports the Bluetooth audio streaming function. Make sure you correctly connect the device to SYNC, and that you have pressed play on your device. You can also preform the MyFord Touch reset procedure.  |
| SYNC does not recognize music that is on my device.       | Your music files may not contain the correct artist, song title, album or genre information.<br>The file may be corrupted.<br>The song may have copyright protection, which does not allow it to play. | Make sure that all song details are populated. Some devices require you to change the USB settings from mass storage to MTP class.  |

## MyFord Touch™ (If Equipped)

| <b>Vehicle Health Report and Services (Traffic, Directions and Information) issues</b> |   |   |
|--|---|---|
| <b>Issue</b>   | <b>Possible cause(s)</b>  | <b>Possible solution(s)</b>   |
| I received a text that I did not activate Vehicle Health Report.                       | You did not activate your account on the website.<br>You may have the wrong VIN (vehicle identification number) listed.               | This is a free feature, but you must first register online to use it.<br>Make sure that your VIN is correctly listed in your account.   |
| I am unable to retrieve the report on the website, or I receive a system error.        | The preferred dealer information did not load correctly.  | When you register your account, you must choose a preferred dealer. If it already lists a dealer, try selecting another dealer and logging out. Log back in, change it back to your preferred dealer, and retrieve the report.  |
| I am unable to submit a report.  | This could be due to your phone's compatibility.<br>Bad signal strength.<br>You did not register your phone correctly on the website. | Update your cellular number in your account on the website.<br>Make sure you have full signal strength and that your Bluetooth volume level has been turned up.<br>Make sure the currently connected phone is registered on your SYNCMyRide account.<br>Try deleting your phone and performing a clean pairing. |
| I heard a commercial when I tried to use Traffic, Directions and Information.          | You did not activate this phone for this service.<br>Your phone has ID blocker active.  | This is a free feature, but you must first register online to use it.<br>Turn off ID blocker on your phone as the system recognizes you by your phone number.<br>Make sure the currently connected phone is the same one that is registered on your SYNCMyRide account.   |

## MyFord Touch™ (If Equipped)

| <b>Voice command issues</b>  |   |   |
|--|---|---|
| <b>Issue</b>   | <b>Possible cause(s)</b>  | <b>Possible solution(s)</b>   |
| SYNC does not understand what I am saying.   | You may be using the wrong voice commands.<br>You may be speaking too soon or at the wrong time.  | Review the phone voice commands and the media voice commands at the beginning of their respective sections.<br>After pressing the voice icon, wait until the system prompts you to begin saying a command. Any command spoken before this does not register with the system.  |
| SYNC does not understand the name of a song or artist.                               | You may be using the wrong voice commands.<br>You may be saying the name differently than the way you saved it.<br>The system may not be reading the name the same way you are saying it. | Review the media voice commands at the beginning of the media section.<br>Say the song or artist exactly as listed. If you say "Play Artist Prince", the system does not play music by Prince and the Revolution or Prince and the New Power Generation.<br>Make sure you are saying the complete title, such as "California remix featuring Jennifer Nettles".<br>If the song titles are in all CAPS, you have to spell them. LOLA requires you to say "L-O-L-A".<br>Do not use special characters in the title. The system does not recognize them. |
| SYNC does not understand or is calling the wrong contact when I want to make a call. | You may be using the wrong voice commands.<br>You may be saying the name differently than the way you saved it.<br>The system may not be reading the name the same way you are saying it. | Review the Phone voice commands at the beginning of the phone section.<br>Make sure you are saying the contacts exactly as they are listed. For example, if you save a contact as Joe Wilson, say "Call Joe Wilson".  |

## MyFord Touch™ (If Equipped)

| <b>Voice command issues</b> |   |  |
|-----------------------------|---|--|
| <b>Issue</b>                | <b>Possible cause(s)</b>  | <b>Possible solution(s)</b>  |
|                             | Contacts in your phonebook may be very short and similar, or they may contain special characters. Your phonebook contacts may be in CAPS. | Using the SYNC phone menu, open the phonebook and scroll to the name SYNC is having trouble understanding. SYNC will read the name to you, giving you some idea of the pronunciation SYNC is expecting.<br>The system works better if you list full names, such as "Joe Wilson" rather than "Joe".<br>Do not use special characters, such as 123 or ICE, as the system does not recognize them.<br>If a contact is in CAPS, you have to spell it. JAKE requires you to say "Call J-A-K-E". |

### **Touchscreen System Reset**

The touchscreen system has a system reset feature that can be performed if the function of a SYNC feature is lost. This reset is intended to restore functionality and will not erase any information previously stored in the system (such as paired devices, phonebook, call history, text messages, or user settings). To perform a System Reset, press and hold the Seek Up (>>) button while pressing and holding the Radio Power button. After approximately 5 seconds the screen will go black. Allow a 1-2 minutes for the system reset to complete. You may then resume using the SYNC system.

# Accessories

---

For a complete listing of the accessories that are available for your vehicle, please contact your authorized dealer or visit the online store web site:

|                                    |
|------------------------------------|
| <b>Web Address (United States)</b> |
|------------------------------------|

|  |
|--|
| <a href="http://www.Accessories.Ford.com">www.Accessories.Ford.com</a> |
|--|

|                             |
|-----------------------------|
| <b>Web Address (Canada)</b> |
|-----------------------------|

|  |
|--|
| <a href="http://www.Accessories.Ford.ca">www.Accessories.Ford.ca</a> |
|--|

Ford Motor Company will repair or replace any properly authorized dealer-installed Ford Original Accessory found to be defective in factory-supplied materials or workmanship during the warranty period, as well as any component damaged by the defective accessories.

Ford Motor Company will warrant your Ford accessory through the warranty that provides the greatest benefit:

- 24 months, unlimited mileage.
- The remainder of your new vehicle limited warranty.

Contact an authorized dealer for details and a copy of the warranty.

## Exterior Style

- Bumper protector.
- Hood deflectors.
- Side window deflectors.
- Splash guards.

## Interior Style

- Ambient lighting.
- Cargo area protector.
- Floor mats.
- Rear console.
- Seat covers\*.

## Lifestyle

- Ash cup or smoker's package.
- Camping tent\*.
- Car covers\*.
- Cargo organization and management.
- Rear seat entertainment\*.
- Roof crossbars.
- Roof racks and carriers\*.
- Trailer hitch balls.
- Trailer hitch drawbars and towing accessories.

## Peace of Mind

- Cargo shade.
- In-vehicle safe\*.
- Keyless entry keypad.
- Parking sensors\*.
- Remote start.
- Roadside assistance kits\*.
- Vehicle security systems.
- Wheel locks.

\*Ford Licensed Accessories. The accessory manufacturer designs, develops and therefore warrants Ford Licensed Accessories, and does not design or test these accessories to Ford Motor Company engineering requirements. Contact an authorized Ford dealer for the manufacturer's limited warranty details, and request a copy of the Ford Licensed Accessories product limited warranty from the accessory manufacturer.

# Accessories

---

For maximum vehicle performance, keep the following information in mind when adding accessories or equipment to your vehicle:

- When adding accessories, equipment, passengers and luggage to your vehicle, do not exceed the total weight capacity of the vehicle or of the front or rear axle (GVWR or GAWR as indicated on the Safety Compliance Certification label). Ask an authorized dealer for specific weight information.
- The Federal Communications Commission (FCC) and Canadian Radio Telecommunications Commission (CRTC) regulate the use of mobile communications systems that are equipped with radio transmitters, for example, two-way radios, telephones and theft alarms. Any such equipment installed in your vehicle should comply with Federal Communications Commission (FCC) and Canadian Radio Telecommunications Commission (CRTC) regulations and should be installed only by an authorized dealer.
- An authorized dealer needs to install mobile communications systems. Improper installation may harm the operation of your vehicle, particularly if the manufacturer did not design the mobile communication system specifically for automotive use.
- If you or an authorized Ford dealer add any non-Ford electrical or electronic accessories or components to your vehicle, you may adversely affect battery performance and durability. In addition, you may also adversely affect the performance of other electrical systems in the vehicle.

# Extended Service Plan (ESP)

---

PROTECT YOURSELF FROM THE RISING COST OF VEHICLE REPAIRS WITH A FORD EXTENDED SERVICE PLAN.

## **EXTENDED SERVICE PLAN (U.S. Only)**

More than 32 million Ford owners have discovered the powerful protection of Ford Extended Service Plan. It is the extended service plan backed by Ford Motor Company, and provides peace of mind protection beyond the New Vehicle Limited Warranty coverage.

### **Ford ESP Can Quickly Pay for Itself**

One service bill – the cost of parts and labor – can easily exceed the price of your Ford Extended Service Plan. With Ford ESP you minimize your risk for unexpected repair bills and rising repair costs.

### **Up to 1,000+ Covered Vehicle Components**

There are four core Extended Service Plans with different levels of coverage. Ask your authorized dealer for details.

1. PremiumCARE - Our most comprehensive coverage. With over 1,000 covered components, this plan is so complete that we generally only discuss what's not covered.
2. ExtraCARE - Covers 113 components, and includes many high-tech items.
3. BaseCARE - Covers 84 components.
4. PowertrainCARE - Covers 29 critical components.

Ford Extended Service Plan is honored by all authorized Ford dealers in the U.S., Canada and Mexico. It is the extended service plan authorized and backed by Ford Motor Company.

That means you get:

- Reliable, quality service at any Ford or Lincoln dealership
- Repairs performed by factory trained technicians, using genuine parts

### **Rental Car Reimbursement**

#### ***1st day Rental Benefit***

You take advantage of replacement transportation if your vehicle is at your authorized dealer for same day covered repairs.

#### ***Extended Rental Benefits***

If your vehicle is kept overnight for covered repairs, you are eligible for rental car coverage, including bumper to bumper warranty repairs, and Field Service Actions.

### **Roadside Assistance**

Exclusive 24/7 roadside assistance, including:

- Towing, flat-tire change and battery jump starts
- Out of fuel and lock-out assistance.
- Travel expense reimbursement for lodging, meals and rental car.
- Destination assistance for taxi, shuttle, rental car coverage and emergency transportation.

### **Transferable Coverage**

If you sell your vehicle before your Ford Extended Service Plan coverage expires, you can transfer any remaining coverage to the new owner. Whenever you sell your vehicle, prospective buyers may have a higher degree of confidence that vehicle was properly maintained with Ford ESP, thereby improving resale value.

# Extended Service Plan (ESP)

---

## Avoid the Rising Cost of Properly Maintaining Your Vehicle!

Ford Extended Service Plan also offers a Premium Maintenance Plan that covers all scheduled maintenance, and selected wear items. The coverage is prepaid, so you never have to worry about affording your vehicle's maintenance. It covers regular checkups, routine inspections, preventive care and replacement of select items that require periodic attention for normal wear:

- Windshield wiper blades.
- Spark plugs.
- The clutch disc.
- Brake pads and linings.
- Shock absorbers.
- Struts.
- Engine Belts.
- Engine coolant hoses, clamps and o-rings.
- Diesel exhaust fluid replenishment.

## Interest Free Finance Options Available

Take advantage of our interest free installment payment plan. Just a 10% down payment will provide you with an affordable, no interest, no fee payment program allowing you all the security and benefits Ford ESP has to offer while paying over time. You are pre-approved with no credit checks, no hassles! To learn more, call our Ford ESP specialists at 800-367-3377.

Ford ESP  
P.O. Box 321067  
Detroit, MI 48232

## EXTENDED SERVICE PLAN (CANADA ONLY)

You can get more protection for your vehicle by purchasing a Ford Extended Service Plan. Ford Extended Service Plan is the only service contract backed by Ford Motor Company of Canada, Limited. Depending on the plan you purchase, Ford Extended Service Plan provides benefits such as:

- Rental reimbursement.
- Coverage for certain maintenance and wear items.
- Protection against repair costs after your New Vehicle Limited Warranty Coverage expires.
- Roadside Assistance benefits.

There are several Ford Extended Service Plans available in various time, distance and deductible combinations. Each plan is tailored to fit your own driving needs, including reimbursement for towing and rental. When you purchase Ford Extended Service Plan, you receive added peace-of-mind protection throughout Canada, the United States and Mexico, provided by a network of participating authorized Ford Motor Company dealers.

**Note:** *Repairs performed outside of Canada, the United States and Mexico are not eligible for Ford Extended Service Plan coverage.*

This information is subject to change. For more information, visit your local Ford of Canada dealer or [www.ford.ca](http://www.ford.ca) to find the Ford Extended Service Plan that is right for you.



# Scheduled Maintenance

---

## GENERAL MAINTENANCE INFORMATION

### Why Maintain Your Vehicle?

Carefully following the maintenance schedule helps protect against major repair expenses resulting from neglect or inadequate maintenance and may help to increase the value of your vehicle when you sell or trade it. Keep all receipts for completed maintenance with your vehicle.

We have established regular maintenance intervals for your vehicle based upon rigorous testing. It is important that you have your vehicle serviced at the proper times. These intervals serve two purposes; one is to maintain the reliability of your vehicle and the second is to keep your cost of owning your vehicle down.

It is your responsibility to have all scheduled maintenance performed and to make sure that the materials used meet the specifications identified in this owner's manual. See **Capacities and Specifications** (page 331).

Failure to perform scheduled maintenance invalidates warranty coverage on parts affected by the lack of maintenance.

### Why Maintain Your Vehicle at Your Dealership?

#### Factory-Trained Technicians

Service technicians participate in extensive factory-sponsored certification training to help them become experts on the operation of your vehicle. Ask your dealership about the training and certification their technicians have received.

### Genuine Ford and Motorcraft® Replacement Parts

Dealerships stock Ford, Motorcraft and Ford-authorized branded re-manufactured replacement parts. These parts meet or exceed our specifications. Parts installed at your dealership carry a nationwide 24-month or unlimited mile (kilometer) parts and labor limited warranty.

If you do not use Ford authorized parts they may not meet our specifications and depending on the part, it could affect emissions compliance.

### Convenience

Many dealerships have extended evening and Saturday hours to make your service visit more convenient and they offer one stop shopping. They can perform any services that are required on your vehicle, from general maintenance to collision repairs.

**Note:** *Not all dealers have extended hours or body shops. Please contact your dealer for details.*

### Protecting Your Investment

Maintenance is an investment that pays dividends in the form of improved reliability, durability and resale value. To maintain the proper performance of your vehicle and its emission control systems, make sure you have scheduled maintenance performed at the designated intervals.

Your vehicle is equipped with the Intelligent Oil-Life Monitor system, which displays a message in the information display at the proper oil change interval. This interval may be up to one year or 10000 miles (16000 kilometers).

# Scheduled Maintenance

---

When the oil change message appears in the information display, it is time for an oil change. Make sure you perform the oil change within two weeks or 500 miles (800 kilometers) of the message appearing. Make sure you reset the Intelligent Oil-Life Monitor after each oil change. See **Oil Change Indicator Reset** (page 279).

If your information display resets prematurely or becomes inoperative, you should perform the oil change interval at six months or 5000 miles (8000 kilometers) from your last oil change. Never exceed one year or 10000 miles (16000 kilometers) between oil change intervals.

Your vehicle is very sophisticated and built with multiple, complex, performance systems. Every manufacturer develops these systems using different specifications and performance features. That is why it is important to rely upon your dealership to properly diagnose and repair your vehicle.

Ford Motor Company has recommended maintenance intervals for various parts and component systems based upon engineering testing. Ford Motor Company relies upon this testing to determine the most appropriate mileage for replacement of oils and fluids to protect your vehicle at the lowest overall cost to you and recommends against maintenance schedules that deviate from the scheduled maintenance information.

We strongly recommend the use of only genuine Ford, Motorcraft or Ford-authorized re-manufactured replacement parts engineered for your vehicle.

## Additives and Chemicals

This owner's manual and the Ford Workshop Manual list the recommended additives and chemicals for your vehicle. We do not recommend using chemicals or additives not approved by us as part of your vehicle's normal maintenance. Please consult your warranty information.

## Oils, Fluids and Flushing

In many cases, fluid discoloration is a normal operating characteristic and, by itself, does not necessarily indicate a concern or that the fluid needs to be changed. However, a qualified expert, such as the factory-trained technicians at your dealership, should inspect discolored fluids that also show signs of overheating or foreign material contamination immediately.

Make sure to change your vehicle's oils and fluids at the specified intervals or in conjunction with a repair. Flushing is a viable way to change fluid for many vehicle sub-systems during scheduled maintenance. It is critical that systems are flushed only with new fluid that is the same as that required to fill and operate the system or using a Ford-approved flushing chemical.

## Owner Checks and Services

Make sure you perform the following basic maintenance checks and inspections every month or at six-month intervals.

# Scheduled Maintenance

---

| <b>Check every month</b>                              |
|---|
| Engine oil level.                                     |
| Function of all interior and exterior lights.         |
| Tires (including spare) for wear and proper pressure. |
| Windshield washer fluid level.                        |

| <b>Check every six months</b>   |
|---|
| Battery connections. Clean if necessary.  |
| Body and door drain holes for obstructions. Clean if necessary.                 |
| Cooling system fluid level and coolant strength.                                |
| Door weatherstrips for wear. Lubricate if necessary.                            |
| Hinges, latches and outside locks for proper operation. Lubricate if necessary. |
| Parking brake for proper operation.   |
| Safety belts and seat latches for wear and function.                            |
| Safety warning lamps (brake, ABS, airbag and safety belt) for operation.        |
| Washer spray and wiper operation. Clean or replace blades as necessary.         |

## Multi-Point Inspection

In order to keep your vehicle running right, it is important to have the systems on your vehicle checked regularly. This can help identify potential issues and prevent major problems. We recommend having the following multi-point inspection performed at every scheduled maintenance interval to help make sure your vehicle keeps running great.

# Scheduled Maintenance

| Multi-Point inspection           |  |
|----------------------------------|--|
| Accessory drive belt(s)          | Hazard warning system operation                        |
| Battery performance              | Horn operation   |
| Engine air filter                | Radiator, cooler, heater and air conditioning hoses    |
| Exhaust system                   | Suspension components for leaks or damage              |
| Exterior lamps operation         | Steering and linkage                                   |
| Fluid levels*; fill if necessary | Tires (including spare) for wear and proper pressure** |
| For oil and fluid leaks          | Windshield for cracks, chips or pits                   |
| Half-shaft dust boots            | Washer spray and wiper operation                       |

\* Brake, coolant recovery reservoir, automatic transmission and window washer

\*\*If your vehicle is equipped with a temporary mobility kit, check the tire sealant expiration Use By date on the canister. Replace as needed.

Be sure to ask your dealership service advisor or technician about the multi-point vehicle inspection. It is a comprehensive way to perform a thorough inspection of your vehicle. Your checklist gives you immediate feedback on the overall condition of your vehicle.

## NORMAL SCHEDULED MAINTENANCE

### Intelligent Oil-Life Monitor™

Your vehicle is equipped with an Intelligent Oil-Life Monitor that determines when you should change the engine oil based on how your vehicle is used. By using several important factors in its calculations, the monitor helps reduce the cost of owning your vehicle and reduces environmental waste at the same time.

This means you do not have to remember to change the oil on a mileage-based schedule. Your vehicle lets you know when an oil change is due by displaying a message in the information display.

The following table provides examples of vehicle use and its impact on oil change intervals. It is a guideline only. Actual oil change intervals depend on several factors and generally decrease with severity of use.

# Scheduled Maintenance

| <b>When to expect the OIL CHANGE REQUIRED message</b> |  |
|---|--|
| <b>Interval</b>                                       | <b>Vehicle use and example</b>   |
| 7500-10000 miles<br>(12000-16000 km)                  | <b>Normal</b>  |
|   | Normal commuting with highway driving<br>No, or moderate, load or towing<br>Flat to moderately hilly roads<br>No extended idling |
| 5000-7499 miles<br>(8000-11999 km)                    | <b>Severe</b>  |
|   | Moderate to heavy load or towing<br>Mountainous or off-road conditions<br>Extended idling<br>Extended hot or cold operation      |
| 3000-4999 miles<br>(4800-7999 km)                     | <b>Extreme</b>   |
|   | Maximum load or towing<br>Extreme hot or cold operation  |

## Normal Maintenance Intervals

| <b>At every oil change interval as indicated by the information display*</b>                   |
|--|
| Change engine oil and filter.**  |
| Rotate the tires.  |
| Perform a multi-point inspection (recommended).  |
| Inspect the automatic transmission fluid level. Consult your dealer for requirements.          |
| Inspect the brake pads, rotors, hoses and parking brake.                                       |
| Inspect the engine cooling system strength and hoses.  |
| Inspect the exhaust system and heat shields.   |
| Inspect the rear axle and U-joints (AWD only).   |
| Inspect the half-shaft boots.  |
| Inspect the steering linkage, ball joints, suspension, tire-rod ends, driveshaft and U-joints. |

# Scheduled Maintenance

## At every oil change interval as indicated by the information display\*

Inspect the tires, tire wear and measure the tread depth.

Inspect the wheels and related components for abnormal noise, wear, looseness or drag.

\* Do not exceed one year or 10000 miles (16000 kilometers) between service intervals.

\*\* Reset the Intelligent Oil-Life Monitor after engine oil and filter changes. See **Engine Oil Check** (page 278).

## Other maintenance items<sup>1</sup>

|                                |   |
|--------------------------------|---|
| Every 20000 miles (32000 km)   | Replace cabin air filter.                     |
| Every 30000 miles (48000 km)   | Replace engine air filter.                    |
| At 100000 miles (160000 km)    | Change engine coolant. <sup>2</sup>           |
| Every 100000 miles (160000 km) | Replace spark plugs.                          |
|                                | Inspect accessory drive belt(s). <sup>3</sup> |
| Every 150000 miles (240000 km) | Change automatic transmission fluid.          |
|                                | Replace accessory drive belt(s). <sup>4</sup> |

<sup>1</sup> Perform these maintenance items within 3000 miles (4800 kilometers) of the last engine oil and filter change. Do not exceed the designated distance for the interval.

<sup>2</sup> Initial replacement at six years or 100000 miles (160000 kilometers), then every three years or 50000 miles (80000 kilometers).

<sup>3</sup> After initial inspection, inspect every other oil change until replaced.

<sup>4</sup> If not replaced within the last 100000 miles (160000 kilometers).

# Scheduled Maintenance

## SPECIAL OPERATING CONDITIONS SCHEDULED MAINTENANCE

If you operate your vehicle **primarily** in any of the following conditions, you need to perform extra maintenance as indicated. If you operate your vehicle **occasionally** under any of these conditions, it is not necessary to perform the extra maintenance. For specific recommendations, see your dealership service advisor or technician.

Perform the services shown in the following tables when specified or within 3000 miles (4800 kilometers) of the message appearing in your information display prompting you to change your oil.

- **Example 1:** The message comes on at 28751 miles (46270 kilometers). Perform the 30000-mile (48000-kilometer) automatic transmission fluid replacement.
- **Example 2:** The message has **not** come on, but the odometer reads 30000 miles (48000 kilometers) (for example, the Intelligent Oil-Life Monitor was reset at 25000 miles [40000 kilometers]). Perform the engine air filter replacement.

| Towing a trailer or using a car-top carrier |   |
|---|---|
| As required                                 | Change engine oil and filter as indicated by the information display and perform services listed in the Normal Scheduled Maintenance chart. |
| Inspect frequently, service as required     | Inspect rear axle and U-joints (AWD only).  |
|   | Inspect half-shaft boots.   |
|   | See axle maintenance items under <b>Exceptions</b> .  |
| Every 30000 miles (48000 km)                | Change automatic transmission fluid.  |
|   | Change PTU and rear axle fluid (AWD only). See axle maintenance items under <b>Exceptions</b> .   |
| Every 60000 miles (96000 km)                | Replace spark plugs.  |

| Extensive idling or low-speed driving for long distances, as in heavy commercial use |   |
|--|---|
| As required  | Change engine oil and filter as indicated by the information display and perform services listed in the Normal Scheduled Maintenance chart. |
| Inspect frequently, service as required  | Replace cabin air filter.*  |
|  | Replace engine air filter.  |

# Scheduled Maintenance

| <b>Extensive idling or low-speed driving for long distances, as in heavy commercial use</b> |   |
|---|---|
| Every 30000 miles (48000 km)  | Change automatic transmission fluid.  |
|   | Change PTU and rear axle fluid (AWD only). See axle maintenance items under <b>Exceptions</b> . |
| Every 60000 miles (96000 km)  | Replace spark plugs.  |

\* This is an optional feature.

| <b>Operating in dusty or sandy conditions (such as unpaved or dusty roads)</b> |   |
|--|---|
| Inspect frequently, service as required  | Replace cabin air filter.*  |
|  | Replace engine air filter.  |
| Every 5000 miles (8000 km)   | Inspect the wheels and related components for abnormal noise, wear, looseness or drag.          |
|  | Rotate tires, inspect tires for wear and measure tread depth.                                   |
| Every 5000 miles (8000 km) or six months                                       | Change engine oil and filter.**   |
|  | Perform multi-point inspection.   |
| Every 30000 miles (48000 km)   | Change automatic transmission fluid.  |
|  | Change PTU and rear axle fluid (AWD only). See axle maintenance items under <b>Exceptions</b> . |

\* This is an optional feature.

\*\*Reset your Intelligent Oil-Life Monitor after engine oil and filter changes. See **Engine Oil Check** (page 278).

| <b>Exclusive use of E85 (flex fuel vehicles only)</b> |  |
|---|--|
| Every oil change                                      | If ran exclusively on E85, fill the fuel tank full with regular unleaded fuel. |

## Exceptions

There are several exceptions to the Normal Schedule:



# Scheduled Maintenance

**Axle and PTU maintenance:** The Power Transfer Unit (PTU) and rear axle (AWD only) in your vehicle does not require any normal scheduled maintenance. Vehicles are electronically monitored and notify the driver required service by displaying a message in the information display. The PTU lubricant will be more likely to require a change if the vehicle has experienced extended periods of extreme/severe duty cycle driving. Changing or checking the PTU lubricant is not necessary unless the unit has been submerged in water, shows signs of leakage or a message indicating required service is displayed. Contact your authorized dealer for service.

**California fuel filter replacement:** If you register your vehicle in California, the California Air Resources Board has determined that the failure to perform this maintenance item does not nullify the emission warranty or limit recall liability

before the completion of your vehicle's useful life. Ford Motor Company, however, urges you to have all recommended maintenance services performed at the specified intervals and to record all vehicle service.

**Hot climate oil change intervals:**

Vehicles operating in the Middle East, North Africa, Sub-Saharan Africa or locations with similar climates using an American Petroleum Institute (API) Certified for Gasoline Engines (Certification mark) oil of SM or SN quality, the normal oil change interval is 5000 miles (8000 kilometers).

If the available API SM or SN oils are not available, then the oil change interval is 3,000 mi (4,800 km).

**Engine air filter and cabin air filter replacement:**

The life of the engine air filter and cabin air filter is dependent on exposure to dusty and dirty conditions. Vehicles operated in these conditions require frequent inspection and replacement of the engine air filter and cabin air filter.

## SCHEDULED MAINTENANCE RECORD

|  |                     |
|--|---------------------|
| <input type="radio"/> Repair Order #:  | <p>Dealer stamp</p> |
| <input type="radio"/> Distance:  |                     |
| <input type="radio"/> Engine hours (optional):                                       |                     |
| <input type="radio"/> Multi-point inspection (recommended): <input type="checkbox"/> |                     |
| <input type="radio"/> Signature:   |                     |

# Scheduled Maintenance

|  |                     |
|--|---------------------|
| <input type="radio"/> Repair Order #:  | <p>Dealer stamp</p> |
| <input type="radio"/> Distance:  |                     |
| <input type="radio"/> Engine hours (optional):                                       |                     |
| <input type="radio"/> Multi-point inspection (recommended): <input type="checkbox"/> |                     |
| <input type="radio"/> Signature:   |                     |

|  |                     |
|--|---------------------|
| <input type="radio"/> Repair Order #:  | <p>Dealer stamp</p> |
| <input type="radio"/> Distance:  |                     |
| <input type="radio"/> Engine hours (optional):                                       |                     |
| <input type="radio"/> Multi-point inspection (recommended): <input type="checkbox"/> |                     |
| <input type="radio"/> Signature:   |                     |

# Scheduled Maintenance

|  |              |
|--|--------------|
| <input type="radio"/> Repair Order #:  | Dealer stamp |
| <input type="radio"/> Distance:  |              |
| <input type="radio"/> Engine hours (optional):                                       |              |
| <input type="radio"/> Multi-point inspection (recommended): <input type="checkbox"/> |              |
| <input type="radio"/> Signature:   |              |

|  |              |
|--|--------------|
| <input type="radio"/> Repair Order #:  | Dealer stamp |
| <input type="radio"/> Distance:  |              |
| <input type="radio"/> Engine hours (optional):                                       |              |
| <input type="radio"/> Multi-point inspection (recommended): <input type="checkbox"/> |              |
| <input type="radio"/> Signature:   |              |

# Scheduled Maintenance

|  |              |
|--|--------------|
| <input type="radio"/> Repair Order #:  | Dealer stamp |
| <input type="radio"/> Distance:  |              |
| <input type="radio"/> Engine hours (optional):                                       |              |
| <input type="radio"/> Multi-point inspection (recommended): <input type="checkbox"/> |              |
| <input type="radio"/> Signature:   |              |

|  |              |
|--|--------------|
| <input type="radio"/> Repair Order #:  | Dealer stamp |
| <input type="radio"/> Distance:  |              |
| <input type="radio"/> Engine hours (optional):                                       |              |
| <input type="radio"/> Multi-point inspection (recommended): <input type="checkbox"/> |              |
| <input type="radio"/> Signature:   |              |

# Scheduled Maintenance

|  |                     |
|--|---------------------|
| <input type="radio"/> Repair Order #:  | <p>Dealer stamp</p> |
| <input type="radio"/> Distance:  |                     |
| <input type="radio"/> Engine hours (optional):                                       |                     |
| <input type="radio"/> Multi-point inspection (recommended): <input type="checkbox"/> |                     |
| <input type="radio"/> Signature:   |                     |

|  |                     |
|--|---------------------|
| <input type="radio"/> Repair Order #:  | <p>Dealer stamp</p> |
| <input type="radio"/> Distance:  |                     |
| <input type="radio"/> Engine hours (optional):                                       |                     |
| <input type="radio"/> Multi-point inspection (recommended): <input type="checkbox"/> |                     |
| <input type="radio"/> Signature:   |                     |

# Scheduled Maintenance

|  |                     |
|--|---------------------|
| <input type="radio"/> Repair Order #:  | <p>Dealer stamp</p> |
| <input type="radio"/> Distance:  |                     |
| <input type="radio"/> Engine hours (optional):                                       |                     |
| <input type="radio"/> Multi-point inspection (recommended): <input type="checkbox"/> |                     |
| <input type="radio"/> Signature:   |                     |

|  |                     |
|--|---------------------|
| <input type="radio"/> Repair Order #:  | <p>Dealer stamp</p> |
| <input type="radio"/> Distance:  |                     |
| <input type="radio"/> Engine hours (optional):                                       |                     |
| <input type="radio"/> Multi-point inspection (recommended): <input type="checkbox"/> |                     |
| <input type="radio"/> Signature:   |                     |

# Scheduled Maintenance

|  |              |
|--|--------------|
| <input type="radio"/> Repair Order #:  | Dealer stamp |
| <input type="radio"/> Distance:  |              |
| <input type="radio"/> Engine hours (optional):                                       |              |
| <input type="radio"/> Multi-point inspection (recommended): <input type="checkbox"/> |              |
| <input type="radio"/> Signature:   |              |

|  |              |
|--|--------------|
| <input type="radio"/> Repair Order #:  | Dealer stamp |
| <input type="radio"/> Distance:  |              |
| <input type="radio"/> Engine hours (optional):                                       |              |
| <input type="radio"/> Multi-point inspection (recommended): <input type="checkbox"/> |              |
| <input type="radio"/> Signature:   |              |

# Scheduled Maintenance

|  |              |
|--|--------------|
| <input type="radio"/> Repair Order #:  | Dealer stamp |
| <input type="radio"/> Distance:  |              |
| <input type="radio"/> Engine hours (optional):                                       |              |
| <input type="radio"/> Multi-point inspection (recommended): <input type="checkbox"/> |              |
| <input type="radio"/> Signature:   |              |

|  |              |
|--|--------------|
| <input type="radio"/> Repair Order #:  | Dealer stamp |
| <input type="radio"/> Distance:  |              |
| <input type="radio"/> Engine hours (optional):                                       |              |
| <input type="radio"/> Multi-point inspection (recommended): <input type="checkbox"/> |              |
| <input type="radio"/> Signature:   |              |



# Scheduled Maintenance

|  |              |
|--|--------------|
| <input type="radio"/> Repair Order #:  | Dealer stamp |
| <input type="radio"/> Distance:  |              |
| <input type="radio"/> Engine hours (optional):                                       |              |
| <input type="radio"/> Multi-point inspection (recommended): <input type="checkbox"/> |              |
| <input type="radio"/> Signature:   |              |

|  |              |
|--|--------------|
| <input type="radio"/> Repair Order #:  | Dealer stamp |
| <input type="radio"/> Distance:  |              |
| <input type="radio"/> Engine hours (optional):                                       |              |
| <input type="radio"/> Multi-point inspection (recommended): <input type="checkbox"/> |              |
| <input type="radio"/> Signature:   |              |

# Scheduled Maintenance

|  |              |
|--|--------------|
| <input type="radio"/> Repair Order #:  | Dealer stamp |
| <input type="radio"/> Distance:  |              |
| <input type="radio"/> Engine hours (optional):                                       |              |
| <input type="radio"/> Multi-point inspection (recommended): <input type="checkbox"/> |              |
| <input type="radio"/> Signature:   |              |

|  |              |
|--|--------------|
| <input type="radio"/> Repair Order #:  | Dealer stamp |
| <input type="radio"/> Distance:  |              |
| <input type="radio"/> Engine hours (optional):                                       |              |
| <input type="radio"/> Multi-point inspection (recommended): <input type="checkbox"/> |              |
| <input type="radio"/> Signature:   |              |

# Scheduled Maintenance

---

|  |                     |
|--|---------------------|
| <input type="radio"/> Repair Order #:  | <p>Dealer stamp</p> |
| <input type="radio"/> Distance:  |                     |
| <input type="radio"/> Engine hours (optional):                                       |                     |
| <input type="radio"/> Multi-point inspection (recommended): <input type="checkbox"/> |                     |
| <input type="radio"/> Signature:   |                     |

# Appendices

---

## END USER LICENSE AGREEMENT

### SYNC End User License Agreement (EULA)

- You have acquired a device ("DEVICE") that includes software licensed by Ford Motor Company and its affiliates ("FORD MOTOR COMPANY") from an affiliate of Microsoft Corporation ("MS"). Those installed software products of MS origin, as well as associated media, printed materials, and "online" or electronic documentation ("MS SOFTWARE") are protected by international intellectual property laws and treaties. The MS SOFTWARE is licensed, not sold. All rights reserved.
- The MS SOFTWARE may interface with and/or communicate with, or may be later upgraded to interface with and/or communicate with additional software and/or systems provided by FORD MOTOR COMPANY. The additional software and systems of FORD MOTOR COMPANY origin, as well as associated media, printed materials, and "online" or electronic documentation ("FORD SOFTWARE") are protected by international intellectual property laws and treaties. The FORD SOFTWARE is licensed, not sold. All rights reserved.

- The MS SOFTWARE and/or FORD SOFTWARE may interface with and/or communicate with, or may be later upgraded to interface with and/or communicate with additional software and/or systems provided by third party software and service suppliers. The additional software and services of third party origin, as well as associated media, printed materials, and "online" or electronic documentation ("THIRD PARTY SOFTWARE") are protected by international intellectual property laws and treaties. The THIRD PARTY SOFTWARE is licensed, not sold. All rights reserved.
- The MS SOFTWARE, FORD SOFTWARE and THIRD PARTY SOFTWARE hereinafter collectively and individually will be referred to as "SOFTWARE".

**IF YOU DO NOT AGREE TO THIS END USER LICENSE AGREEMENT ("EULA") DO NOT USE THE DEVICE OR COPY THE SOFTWARE. ANY USE OF THE SOFTWARE, INCLUDING BUT NOT LIMITED TO USE ON THE DEVICE, WILL CONSTITUTE YOUR AGREEMENT TO THIS EULA (OR RATIFICATION OF ANY PREVIOUS CONSENT).**

**GRANT OF SOFTWARE LICENSE:** This EULA grants you the following license:

- You may use the SOFTWARE as installed on the DEVICE and as otherwise interfacing with systems and/or services provide by or through FORD MOTOR COMPANY or its third party software and service providers.

# Appendices

---

## Description of Other Rights and Limitations

- **Speech Recognition:** If the SOFTWARE includes speech recognition component(s), you should understand that speech recognition is an inherently statistical process and that recognition errors are inherent in the process. Neither FORD MOTOR COMPANY nor its suppliers shall be liable for any damages arising out of errors in the speech recognition process.
- **Limitations on Reverse Engineering, Decompilation and Disassembly:** You may not reverse engineer, decompile, or disassemble nor permit others to reverse engineer, decompile or disassemble the SOFTWARE, except and only to the extent that such activity is expressly permitted by applicable law notwithstanding this limitation.
- **Limitations on Distributing, Copying, Modifying and Creating Derivative Works:** You may not distribute, copy, make modifications to or create derivative works based on the SOFTWARE, except and only to the extent that such activity is expressly permitted by applicable law notwithstanding this limitation.
- **Single EULA:** The end user documentation for the DEVICE and related systems and services may contain multiple EULAs, such as multiple translations and/or multiple media versions (e.g., in the user documentation and in the software). Even if you receive multiple EULAs, you are licensed to use only one (1) copy of the SOFTWARE.
- **SOFTWARE Transfer:** You may permanently transfer your rights under this EULA only as part of a sale or transfer of the DEVICE, provided you retain no copies, you transfer all of the SOFTWARE (including all component parts, the media and printed materials, any upgrades, and, if applicable, the Certificate(s) of Authenticity), and the recipient agrees to the terms of this EULA. If the SOFTWARE is an upgrade, any transfer must include all prior versions of the SOFTWARE.
- **Termination:** Without prejudice to any other rights, FORD MOTOR COMPANY or MS may terminate this EULA if you fail to comply with the terms and conditions of this EULA.
- **Security Updates/Digital Rights Management:** Content owners use the WMDRM technology included in your DEVICE to protect their intellectual property, included copyrighted content. Portions of the SOFTWARE on your DEVICE use WMDRM software to access WMDRM-protected content. If the WMDRM software fails to protect the content, content owners may ask Microsoft to revoke the SOFTWARE's ability to use WMDRM to play or copy protected content. This action does not affect unprotected content. When your DEVICE downloads licenses for protected content, you agree that Microsoft may include a revocation list with the licenses. Content owners may require you to upgrade the SOFTWARE on your DEVICE to access their content. If you decline an upgrade, you will not be able to access content that requires the upgrade.

# Appendices

---

- **Consent to Use of Data:** You agree that MS, Microsoft Corporation, FORD MOTOR COMPANY, third party software and systems suppliers, their affiliates and/or their designated agent may collect and use technical information gathered in any manner as part of product support services related to the SOFTWARE or related services. MS, Microsoft Corporation, FORD MOTOR COMPANY, third party software and services suppliers, their affiliates and/or their designated agent may use this information solely to improve their products or to provide customized services or technologies to you. MS, Microsoft Corporation, FORD MOTOR COMPANY, third party software and systems suppliers, their affiliates and/or their designated agent may disclose this information to others, but not in a form that personally identifies you.

- **Internet-Based Services Components:** The SOFTWARE may contain components that enable and facilitate the use of certain Internet-based services. You acknowledge and agree that MS, Microsoft Corporation, FORD MOTOR COMPANY, third party software and service suppliers, their affiliates and/or their designated agent may automatically check the version of the SOFTWARE and/or its components that you are utilizing and may provide upgrades or supplements to the SOFTWARE that may be automatically downloaded to your DEVICE.

- **Additional Software/Services:** The SOFTWARE may permit FORD MOTOR COMPANY, third party software and service suppliers, MS, Microsoft Corporation, their affiliates and/or their designated agent to provide or make available to you SOFTWARE updates,

supplements, add-on components, or Internet-based services components of the SOFTWARE after the date you obtain your initial copy of the SOFTWARE ("Supplemental Components").

If FORD MOTOR COMPANY or third party software and services suppliers provide or make available to you Supplemental Components and no other EULA terms are provided along with the Supplemental Components, then the terms of this EULA shall apply.

If MS, Microsoft Corporation, their affiliates and/or their designated agent make available Supplemental Components, and no other EULA terms are provided, then the terms of this EULA shall apply, except that the MS, Microsoft Corporation or affiliate entity providing the Supplemental Component(s) shall be the licensor of the Supplemental Component(s).

FORD MOTOR COMPANY, MS, Microsoft Corporation, their affiliates and/or their designated agent reserve the right to discontinue without liability any Internet-based services provided to you or made available to you through the use of the SOFTWARE.

# Appendices

---

- **Links to Third Party Sites:** The MS SOFTWARE may provide you with the ability to link to third party sites through the use of the SOFTWARE. The third party sites are not under the control of MS, Microsoft Corporation, their affiliates and/or their designated agent. Neither MS nor Microsoft Corporation nor their affiliates nor their designated agent are responsible for (i) the contents of any third party sites, any links contained in third party sites, or any changes or updates to third party sites, or (ii) webcasting or any other form of transmission received from any third party sites. If the SOFTWARE provides links to third party sites, those links are provided to you only as a convenience, and the inclusion of any link does not imply an endorsement of the third party site by MS, Microsoft Corporation, their affiliates and/or their designated agent.
- **Obligation to Drive Responsibly:** You recognize your obligation to drive responsibly and keep attention on the road. You will read and abide with the DEVICE operating instructions particularly as they pertain to safety and assumes any risk associated with the use of the DEVICE.

## **UPGRADES AND RECOVERY MEDIA:**

If the SOFTWARE is provided by FORD MOTOR COMPANY separate from the DEVICE on media such as a ROM chip, CD ROM disk(s) or via web download or other means, and is labeled "For Upgrade Purposes Only" or "For Recovery Purposes Only" you may install one (1) copy of such SOFTWARE onto the DEVICE as a replacement copy for the existing SOFTWARE, and use it in accordance with this EULA, including any additional EULA terms accompanying the upgrade SOFTWARE.

## **INTELLECTUAL PROPERTY RIGHTS:**

All title and intellectual property rights in and to the SOFTWARE (including but not limited to any images, photographs, animations, video, audio, music, text and "applets" incorporated into the SOFTWARE), the accompanying printed materials, and any copies of the SOFTWARE, are owned by MS, Microsoft Corporation, FORD MOTOR COMPANY, or their affiliates or suppliers. The SOFTWARE is licensed, not sold. You may not copy the printed materials accompanying the SOFTWARE. All title and intellectual property rights in and to the content which may be accessed through use of the SOFTWARE is the property of the respective content owner and may be protected by applicable copyright or other intellectual property laws and treaties. This EULA grants you no rights to use such content. All rights not specifically granted under this EULA are reserved by MS, Microsoft Corporation, FORD MOTOR COMPANY, third party software and service providers, their affiliates and suppliers. Use of any on-line services which may be accessed through the SOFTWARE may be governed by the respective terms of use relating to such services. If this SOFTWARE contains documentation that is provided only in electronic form, you may print one copy of such electronic documentation.

**EXPORT RESTRICTIONS:** You acknowledge that the SOFTWARE is subject to U.S. and European Union export jurisdiction. You agree to comply with all applicable international and national laws that apply to the SOFTWARE, including the U.S. Export Administration Regulations, as well as end-user, end-use and destination restrictions issued by U.S. and other governments. For additional information, see:

# Appendices

| Website   |
|---|
| <a href="http://www.microsoft.com/exporting/">http://www.microsoft.com/exporting/</a> |

**TRADEMARKS:** This EULA does not grant you any rights in connection with any trademarks or service marks of FORD MOTOR COMPANY, MS, Microsoft Corporation, third party software or service providers, their affiliates or suppliers.

**PRODUCT SUPPORT:** Product support for the SOFTWARE is not provided by MS, its parent corporation Microsoft Corporation, or their affiliates or subsidiaries. For product support, please refer to FORD MOTOR COMPANY instructions provided in the documentation for the DEVICE. Should you have any questions concerning this EULA, or if you desire to contact FORD MOTOR COMPANY for any other reason, please refer to the address provided in the documentation for the DEVICE.

**No Liability for Certain Damages:** EXCEPT AS PROHIBITED BY LAW, FORD MOTOR COMPANY, ANY THIRD PARTY SOFTWARE OR SERVICES SUPPLIERS, MS, MICROSOFT CORPORATION AND THEIR AFFILIATES SHALL HAVE NO LIABILITY FOR ANY INDIRECT, SPECIAL, CONSEQUENTIAL OR INCIDENTAL DAMAGES ARISING FROM OR IN CONNECTION WITH THE USE OR PERFORMANCE OF THE SOFTWARE. THIS LIMITATION SHALL APPLY EVEN IF ANY REMEDY FAILS OF ITS ESSENTIAL PURPOSE. IN NO EVENT SHALL MS, MICROSOFT CORPORATION AND/OR THEIR AFFILIATES BE LIABLE FOR ANY AMOUNT IN EXCESS OF U.S. TWO HUNDRED FIFTY DOLLARS (U.S. \$250.00).

- THERE ARE NO WARRANTIES OTHER THAN THOSE THAT MAY EXPRESSLY BE PROVIDED FOR YOUR NEW VEHICLE.

## Adobe

Contains Adobe® [Flash® Player] or [AIR®] technology by Adobe Systems Incorporated. This [Licensee Product] contains [Adobe® Flash® Player] [Adobe® AIR®] software under license from Adobe Systems Incorporated, Copyright ©1995-2009 Adobe Macromedia Software LLC. All rights reserved. Adobe, Flash and AIR are trademarks of Adobe Systems Incorporated.

## End User Notice

### **Microsoft® Windows® Mobile for Automotive Important Safety Information**

This system Ford SYNC contains software that is licensed to Manufacturer FORD MOTOR COMPANY by an affiliate of Microsoft Corporation pursuant to a license agreement. Any removal, reproduction, reverse engineering or other unauthorized use of the software from this system in violation of the license agreement is strictly prohibited and may subject you to legal action.

**Read and follow instructions:** Before using your Windows Automotive- based system, read and follow all instructions and safety information provided in this end user manual ("User's Guide"). Not following precautions found in this User's Guide can lead to an accident or other serious consequences.



# Appendices

---

**Keep User's Guide in vehicle:** When kept in the vehicle, the User's Guide will be a ready reference for you and other users unfamiliar with the Windows Automotive-based system. Please make certain that before using the system for the first time, all persons have access to the User's Guide and read its instructions and safety information carefully.

## WARNING



Operating certain parts of this system while driving can distract your attention away from the road, and possibly cause an accident or other serious consequences. Do not change system settings or enter data non-verbally (using your hands) while driving. Stop the vehicle in a safe and legal manner before attempting these operations. This is important since while setting up or changing some functions you might be required to distract your attention away from the road and remove your hands from the wheel.

---

## General Operation

**Voice Command Control:** Functions within the Windows Automotive-based system may be accomplished using only voice commands. Using voice commands while driving allows you to operate the system without removing your hands from the wheel.

**Prolonged Views of Screen:** Do not access any function requiring a prolonged view of the screen while you are driving. Pull over in a safe and legal manner before attempting to access a function of the system requiring prolonged attention. Even occasional short scans to the screen may be hazardous if your attention has been diverted away from your driving task at a critical time.

**Volume Setting:** Do not raise the volume excessively. Keep the volume at a level where you can still hear outside traffic and emergency signals while driving. Driving while unable to hear these sounds could cause an accident.

**Use of Speech Recognition Functions:** Speech recognition software is inherently a statistical process which is subject to errors. It is your responsibility to monitor any speech recognition functions included in the system and address any errors.

**Navigation Features:** Any navigation features included in the system are intended to provide turn by turn instructions to get you to a desired destination. Please make certain all persons using this system carefully read and follow instructions and safety information fully.

**Distraction Hazard:** Any navigation features may require manual (non-verbal) setup. Attempting to perform such set-up or insert data while driving can seriously distract your attention and could cause an accident or other serious consequences. Stop the vehicle in a safe and legal manner before attempting these operations.

**Let Your Judgment Prevail:** Any navigation features are provided only as an aid. Make your driving decisions based on your observations of local conditions and existing traffic regulations. Any such feature is not a substitute for your personal judgment. Any route suggestions made by this system should never replace any local traffic regulations or your personal judgment or knowledge of safe driving practices.

# Appendices

---

**Route Safety:** Do not follow the route suggestions if doing so would result in an unsafe or illegal maneuver, if you would be placed in an unsafe situation, or if you would be directed into an area that you consider unsafe. The driver is ultimately responsible for the safe operation of the vehicle and therefore, must evaluate whether it is safe to follow the suggested directions.

**Potential Map Inaccuracy:** Maps used by this system may be inaccurate because of changes in roads, traffic controls or driving conditions. Always use good judgment and common sense when following the suggested routes.

**Emergency Services:** Do not rely on any navigation features included in the system to route you to emergency services. Ask local authorities or an emergency services operator for these locations. Not all emergency services such as police, fire stations, hospitals and clinics are likely to be contained in the map database for such navigation features.

## **Telenav Software End User License Agreement**

Please read these terms and conditions carefully before you use the Telenav Software. Your use of the Telenav Software indicates that you accept these terms and conditions. If you do not accept these terms and conditions, do not break the seal of the package, launch, or otherwise use the Telenav Software.

These terms and conditions represent the agreement ("Agreement") between you and Telenav, Inc. ("Telenav") with respect to the Telenav Software (including upgrades, modifications, or additions thereto) (collectively "Telenav Software"). All references herein to "you" and "your" means you, your employees, agents, and contractors, and any other entity on whose behalf you accept these terms and

conditions, all of whom shall also be bound by this Agreement. Additionally, all of your account information, as well as other payment and personal information provided by you to Telenav (directly or through the use of the Telenav Software, is subject to Telenav's privacy policy located at <http://www.telenav.com>.

Telenav may revise this Agreement and the privacy policy at any time, with or without notice to you. You agree to visit <http://www.telenav.com> from time to time to review the then current version of this Agreement and of the privacy policy.

### **1. Safe and Lawful Use**

You acknowledge that devoting attention to the Telenav Software may pose a risk of injury or death to you and others in situations that otherwise require your undivided attention, and you therefore agree to comply with the following when using the Telenav Software: (a) observe all traffic laws and otherwise drive safely; (b) use your own personal judgment while driving. If you feel that a route suggested by the Telenav Software instructs you to perform an unsafe or illegal maneuver, places you in an unsafe situation, or directs you into an area that you consider to be unsafe, do not follow such instructions; (c) do not input destinations, or otherwise manipulate the Telenav Software, unless your vehicle is stationary and parked; (d) do not use the Telenav Software for any illegal, unauthorized, unintended, unsafe, hazardous, or unlawful purposes, or in any manner inconsistent with this Agreement; (e) arrange all GPS and wireless devices and cables necessary for use of the Telenav Software in a secure manner in your vehicle so that they will not interfere with your driving and will not prevent the operation of any safety device (such as an airbag).

# Appendices

---

You agree to indemnify and hold Telenav harmless against all claims resulting from any dangerous or otherwise inappropriate use of the Telenav Software in any moving vehicle, including as a result of your failure to comply with the directions above.

## **2. Account Information**

You agree: (a) when registering the Telenav Software, to provide Telenav with true, accurate, current, and complete information about yourself, and (b) to inform Telenav promptly of any changes to such information, and to keep it true, accurate, current and complete.

## **3. Software License**

Subject to your compliance with the terms of this Agreement, Telenav hereby grants to you a personal, non-exclusive, non-transferable license (except as expressly permitted below in connection with your permanent transfer of the Telenav Software license), without the right to sublicense, to use the Telenav Software (in object code form only) in order to access and use the Telenav Software. This license shall terminate upon any termination or expiration of this Agreement. You agree that you will use the Telenav Software only for your personal business or leisure purposes, and not to provide commercial navigation services to other parties.

### **3.1 License Limitations**

You agree not to do any of the following: (a) reverse engineer, decompile, disassemble, translate, modify, alter or otherwise change the Telenav Software or any part thereof; (b) attempt to derive the source code, audio library or structure of the Telenav Software without the prior express written consent of Telenav; (c) remove from the Telenav Software, or alter, any of Telenav's or its suppliers' trademarks, trade names, logos, patent or

copyright notices, or other notices or markings; (d) distribute, sublicense or otherwise transfer the Telenav Software to others, except as part of your permanent transfer of the Telenav Software; or (e) use the Telenav Software in any manner that (i) infringes the intellectual property or proprietary rights, rights of publicity or privacy or other rights of any party, (ii) violates any law, statute, ordinance or regulation, including but not limited to laws and regulations related to spamming, privacy, consumer and child protection, obscenity or defamation, or (iii) is harmful, threatening, abusive, harassing, tortuous, defamatory, vulgar, obscene, libelous, or otherwise objectionable; and (f) lease, rent out, or otherwise permit unauthorized access by third parties to the Telenav Software without advanced written permission of Telenav.

## **4. Disclaimers**

To the fullest extent permissible pursuant to applicable law, in no event will Telenav, its licensors and suppliers, or agents or employees of any of the foregoing, be liable for any decision made or action taken by you or anyone else in reliance on the information provided by the Telenav Software. Telenav also does not warrant the accuracy of the map or other data used for the Telenav Software. Such data may not always reflect reality due to, among other things, road closures, construction, weather, new roads and other changing conditions. You are responsible for the entire risk arising out of your use of the Telenav Software. For example but without limitation, you agree not to rely on the Telenav Software for critical navigation in areas where the well-being or survival of you or others is dependent on the accuracy of navigation, as the maps or functionality of the Telenav Software are not intended to support such high risk applications, especially in more remote geographical areas.

# Appendices

---

TELENAV EXPRESSLY DISCLAIMS AND EXCLUDES ALL WARRANTIES IN CONNECTION WITH THE TELENAV SOFTWARE, WHETHER STATUTORY, EXPRESS OR IMPLIED, INCLUDING ALL WARRANTIES WHICH MAY ARISE FROM COURSE OF DEALING, CUSTOM OR TRADE AND INCLUDING, BUT NOT LIMITED TO, THE IMPLIED WARRANTIES OF MERCHANTABILITY, FITNESS FOR A PARTICULAR PURPOSE AND NON-INFRINGEMENT OF THIRD PARTY RIGHTS WITH RESPECT TO THE TELENAV SOFTWARE. Certain jurisdictions do not permit the disclaimer of certain warranties, so this limitation may not apply to you.

## **5. Limitation of Liability**

TO THE EXTENT PERMITTED UNDER APPLICABLE LAW, UNDER NO CIRCUMSTANCES SHALL TELENAV OR ITS LICENSORS AND SUPPLIERS BE LIABLE TO YOU OR TO ANY THIRD PARTY FOR ANY INDIRECT, INCIDENTAL, CONSEQUENTIAL, SPECIAL OR EXEMPLARY DAMAGES (INCLUDING IN EACH CASE, BUT NOT LIMITED TO, DAMAGES FOR THE INABILITY TO USE THE EQUIPMENT OR ACCESS DATA, LOSS OF DATA, LOSS OF BUSINESS, LOSS OF PROFITS, BUSINESS INTERRUPTION OR THE LIKE) ARISING OUT OF THE USE OF OR INABILITY TO USE THE TELENAV SOFTWARE, EVEN IF TELENAV HAS BEEN ADVISED OF THE POSSIBILITY OF SUCH DAMAGES.

NOTWITHSTANDING ANY DAMAGES THAT YOU MIGHT INCUR FOR ANY REASON WHATSOEVER (INCLUDING, WITHOUT LIMITATION, ALL DAMAGES REFERENCED HEREIN AND ALL DIRECT OR GENERAL DAMAGES IN CONTRACT, TORT (INCLUDING NEGLIGENCE) OR OTHERWISE), THE ENTIRE LIABILITY OF TELENAV AND OF ALL OF TELENAV'S SUPPLIERS SHALL BE LIMITED TO THE AMOUNT ACTUALLY PAID BY YOU FOR

THE TELENAV SOFTWARE. SOME STATES AND/OR JURISDICTIONS DO NOT ALLOW THE EXCLUSION OR LIMITATION OF INCIDENTAL OR CONSEQUENTIAL DAMAGES, SO THE ABOVE LIMITATIONS OR EXCLUSIONS MAY NOT APPLY TO YOU.

## **6. Arbitration and Governing Law**

You agree that any dispute, claim or controversy arising out of or relating to this Agreement or the Telenav Software shall be settled by independent arbitration involving a neutral arbitrator and administered by the American Arbitration Association in the County of Santa Clara, California. The arbitrator shall apply the Commercial Arbitration Rules of the American Arbitration Association, and the judgment upon the award rendered by the arbitrator may be entered by any court having jurisdiction. Note that there is no judge or jury in an arbitration proceeding and the decision of the arbitrator shall be binding upon both parties. You expressly agree to waive your right to a jury trial.

This Agreement and performance hereunder will be governed by and construed in accordance with the laws of the State of California, without giving effect to its conflict of laws provisions. To the extent judicial action is necessary in connection with the binding arbitration, both Telenav and you agree to submit to the exclusive jurisdiction of the courts of the County of Santa Clara, California. The United Nations Convention on Contracts for the International Sale of Goods shall not apply.

## **7. Assignment**

You may not resell, assign, or transfer this Agreement or any of your rights or obligations, except in totality, in connection with your permanent transfer of the Telenav Software, and expressly conditioned upon the new user of the

# Appendices

---

Telenav Software agreeing to be bound by the terms and conditions of this Agreement. Any such sale, assignment or transfer that is not expressly permitted under this paragraph will result in immediate termination of this Agreement, without liability to Telenav, in which case you and all other parties shall immediately cease all use of the Telenav Software. Notwithstanding the foregoing, Telenav may assign this Agreement to any other party at any time without notice, provided the assignee remains bound by this Agreement.

## **8. Miscellaneous**

### **8.1**

This Agreement constitutes the entire agreement between Telenav and you with respect to the subject matter hereof.

### **8.2**

Except for the limited licenses expressly granted in this Agreement, Telenav retains all right, title and interest in and to the Telenav Software, including without limitation all related intellectual property rights. No licenses or other rights which are not expressly granted in this Agreement are intended to, or shall be, granted or conferred by implication, statute, inducement, estoppel or otherwise, and Telenav and its suppliers and licensors hereby reserve all of their respective rights other than the licenses explicitly granted in this Agreement.

### **8.3**

By using the Telenav Software, you consent to receive from Telenav all communications, including notices, agreements, legally required disclosures or other information in connection with the Telenav Software (collectively, "Notices") electronically. Telenav may provide such

Notices by posting them on Telenav's Website or by downloading such Notices to your wireless device. If you desire to withdraw your consent to receive Notices electronically, you must discontinue your use of the Telenav Software.

### **8.4**

Telenav's or your failure to require performance of any provision shall not affect that party's right to require performance at any time thereafter, nor shall a waiver of any breach or default of this Agreement constitute a waiver of any subsequent breach or default or a waiver of the provision itself.

### **8.5**

If any provision herein is held unenforceable, then such provision will be modified to reflect the intention of the parties, and the remaining provisions of this Agreement will remain in full force and effect.

### **8.6**

The headings in this Agreement are for convenience of reference only, will not be deemed to be a part of this Agreement, and will not be referred to in connection with the construction or interpretation of this Agreement. As used in this Agreement, the words "include" and "including," and variations thereof, will not be deemed to be terms of limitation, but rather will be deemed to be followed by the words "without limitation."

## **9. Other Vendors Terms and Conditions**

The Telenav Software utilizes map and other data licensed to Telenav by third party vendors for the benefit of you and other end users. This Agreement includes end-user terms applicable to these companies (included at the end of this

# Appendices

---

Agreement), and thus your use of the Telenav Software is also subject to such terms. You agree to comply with the following additional terms and conditions, which are applicable to Telenav's third party vendor licensors:

## **9.1 End User Terms Required by HERE North America, LLC**

The data ("Data") is provided for your personal, internal use only and not for resale. It is protected by copyright, and is subject to the following terms and conditions which are agreed to by you, on the one hand, and Telenav ("Telenav") and its licensors (including their licensors and suppliers) on the other hand.

© 2013 HERE. All rights reserved.

The Data for areas of Canada includes information taken with permission from Canadian authorities, including: © Her Majesty the Queen in Right of Canada, © Queen's Printer for Ontario, © Canada Post Corporation, GeoBase®, © Department of Natural Resources Canada.

HERE holds a non-exclusive license from the United States Postal Service® to publish and sell ZIP+4® information.

©United States Postal Service® 2014. Prices are not established, controlled or approved by the United States Postal Service®. The following trademarks and registrations are owned by the USPS: United States Postal Service, USPS, and ZIP+4.

The Data for Mexico includes certain data from Instituto Nacional de Estadística y Geografía.

## **TERMS AND CONDITIONS**

## **9.2 End User Terms Required by NAV2 (Shanghai) Co., Ltd**

The data ("Data") is provided for your personal, internal use only and not for resale. It is protected by copyright, and is subject to the following terms and conditions which are agreed to by you, on the one hand, and NAV2 (Shanghai) Co., Ltd ("NAV2") and its licensors (including their licensors and suppliers) on the other hand.

© 20xx. All rights reserved.

### ***Permitted Use.***

You agree to use this Data together with the Telenav Software solely for the internal business and personal purposes for which you were licensed, and not for service bureau, time-sharing or other similar purposes. Accordingly, but subject to the restrictions set forth in the following paragraphs, you agree not to otherwise reproduce, copy, modify, decompile, disassemble, create any derivative works of, or reverse engineer any portion of this Data, and may not transfer or distribute it in any form, for any purpose, except to the extent permitted by mandatory laws.

### ***Restrictions.***

Except where you have been specifically licensed to do so by Telenav, and without limiting the preceding paragraph, you may not use this Data (a) with any products, systems, or applications installed or otherwise connected to or in communication with vehicles, capable of vehicle navigation, positioning, dispatch, real time route guidance, fleet management or similar applications; or (b) with or in communication with any

# Appendices

---

positioning devices or any mobile or wireless-connected electronic or computer devices, including without limitation cellular phones, palmtop and handheld computers, pagers, and personal digital assistants or PDAs.

## **Warning.**

The Data may contain inaccurate or incomplete information due to the passage of time, changing circumstances, sources used and the nature of collecting comprehensive geographic data, any of which may lead to incorrect results.

## **No Warranty.**

This Data is provided to you "as is," and you agree to use it at your own risk. Telenav and its licensors (and their licensors and suppliers) make no guarantees, representations or warranties of any kind, express or implied, arising by law or otherwise, including but not limited to, content, quality, accuracy, completeness, effectiveness, reliability, fitness for a particular purpose, usefulness, use or results to be obtained from this Data, or that the Data or server will be uninterrupted or error-free.

## **Disclaimer of Warranty:**

TELENAV AND ITS LICENSORS (INCLUDING THEIR LICENSORS AND SUPPLIERS) DISCLAIM ANY WARRANTIES, EXPRESS OR IMPLIED, OF QUALITY, PERFORMANCE, MERCHANTABILITY, FITNESS FOR A PARTICULAR PURPOSE OR NON-INFRINGEMENT. Some States, Territories and Countries do not allow certain warranty exclusions, so to that extent the above exclusion may not apply to you.

## **Disclaimer of Liability:**

TELENAV AND ITS LICENSORS (INCLUDING THEIR LICENSORS AND SUPPLIERS) SHALL NOT BE LIABLE TO YOU: IN RESPECT OF ANY CLAIM, DEMAND OR ACTION, IRRESPECTIVE OF THE NATURE OF THE CAUSE OF THE CLAIM, DEMAND OR ACTION ALLEGING ANY LOSS, INJURY OR DAMAGES, DIRECT OR INDIRECT, WHICH MAY RESULT FROM THE USE OR POSSESSION OF THE INFORMATION; OR FOR ANY LOSS OF PROFIT, REVENUE, CONTRACTS OR SAVINGS, OR ANY OTHER DIRECT, INDIRECT, INCIDENTAL, SPECIAL OR CONSEQUENTIAL DAMAGES ARISING OUT OF YOUR USE OF OR INABILITY TO USE THIS INFORMATION, ANY DEFECT IN THE INFORMATION, OR THE BREACH OF THESE TERMS OR CONDITIONS, WHETHER IN AN ACTION IN CONTRACT OR TORT OR BASED ON A WARRANTY, EVEN IF TELENAV OR ITS LICENSORS HAVE BEEN ADVISED OF THE POSSIBILITY OF SUCH DAMAGES. Some States, Territories and Countries do not allow certain liability exclusions or damages limitations, so to that extent the above may not apply to you.

## **Export Control.**

You shall not export from anywhere any part of the Data or any direct product thereof except in compliance with, and with all licenses and approvals required under, applicable export laws, rules and regulations, including but not limited to the laws, rules and regulations administered by the Office of Foreign Assets Control of the U.S. Department of Commerce and the Bureau of Industry and Security of the U.S. Department of Commerce. To the extent

# Appendices

that any such export laws, rules or regulations prohibit HERE from complying with any of its obligations hereunder to deliver or distribute Data, such failure shall be excused and shall not constitute a breach of this Agreement.

## **Entire Agreement.**

These terms and conditions constitute the entire agreement between Telenav (and its licensors, including their licensors and suppliers) and you pertaining to the subject matter hereof, and supersedes in their entirety any and all written or oral agreements previously existing between us with respect to such subject matter.

## **Governing Law.**

The above terms and conditions shall be governed by the laws of the State of Illinois [insert “Netherlands” where European HERE Data is used], without giving effect to (i) its conflict of laws provisions, or (ii) the United Nations Convention for Contracts for the International Sale of Goods, which is explicitly excluded. You agree to submit to the jurisdiction of the State of Illinois [insert “The Netherlands” where European HERE Data is used] for any and all disputes, claims and actions arising from or in connection with the Data provided to you hereunder.

## **Government End Users.**

If the Data is being acquired by or on behalf of the United States government or any other entity seeking or applying rights similar to those customarily claimed by the United States government, this Data is a “commercial item” as that term is defined at 48 C.F.R. (“FAR”) 2.101, is licensed in accordance with these End-User Terms, and each copy of Data delivered or otherwise furnished shall be marked and embedded as appropriate with the following “Notice of Use,” and shall be treated in accordance with such Notice:

### **NOTICE OF USE**

CONTRACTOR (MANUFACTURER/  
SUPPLIER) NAME: HERE

CONTRACTOR (MANUFACTURER/  
SUPPLIER) ADDRESS: c/o Nokia, 425  
West Randolph Street, Chicago, Illinois  
60606

This Data is a commercial item as defined in FAR 2.101 and is subject to these End-User Terms under which this Data was provided.

© 1987 – 2014 HERE – All rights reserved.

If the Contracting Officer, federal government agency, or any federal official refuses to use the legend provided herein, the Contracting Officer, federal government agency, or any federal official must notify HERE prior to seeking additional or alternative rights in the Data.

## **I. US/Canada Territory**

A. United States Data. The End-User Terms for any Application containing Data for the United States shall contain the following notices:

“HERE holds a non-exclusive license from the United States Postal Service® to publish and sell ZIP+4® information.”

“©United States Postal Service® 20XX. Prices are not established, controlled or approved by the United States Postal Service®. The following trademarks and registrations are owned by the USPS: United States Postal Service, USPS, and ZIP+4.”



# Appendices

---

B. Canada Data. The following provisions apply to the Data for Canada, which may include or reflect data from third party licensors (“Third Party Data”), including Her Majesty the Queen in Right of Canada (“Her Majesty”), Canada Post Corporation (“Canada Post”) and the Department of Natural Resources of Canada (“NRCan”):

1. Disclaimer and Limitation: Client agrees that its use of the Third Party Data is subject to the following provisions:

a. Disclaimer: The Third Party Data is licensed on an “as is” basis. The licensors of such data, including Her Majesty, Canada Post and NRCan, make no guarantees, representations or warranties respecting such data, either express or implied, arising by law or otherwise, including but not limited to, effectiveness, completeness, accuracy or fitness for a particular purpose.

b. Limitation on Liability: The Third Party Data licensors, including Her Majesty, Canada Post and NRCan, shall not be liable: (i) in respect of any claim, demand or action, irrespective of the nature of the cause of the claim, demand or action alleging any loss, injury or damages, direct or indirect, which may result from the use or possession of such Data; or (ii) in any way for loss of revenues or contracts, or any other consequential loss of any kind resulting from any defect in the Data.

2. Copyright Notice: In connection with each copy of all or any portion of the Data for the Territory of Canada, Client shall affix in a conspicuous manner the following copyright notice on at least one of: (i) the label for the storage media of the copy; (ii) the packaging for the copy; or (iii) other materials packaged with the copy, such as user manuals or end user license agreements: “This data includes information taken with permission from Canadian authorities, including © Her Majesty the Queen in Right of Canada, © Queen’s Printer for Ontario, © Canada Post Corporation, GeoBase®, © The Department of Natural Resources Canada. All rights reserved.”

3. End-User Terms: Except as otherwise agreed by the parties, in connection with the provision of any portion of the Data for the Territory of Canada to End-Users as may be authorized under the Agreement, Client shall provide such End-Users, in a reasonably conspicuous manner, with terms (set forth with other end user terms required to be provided under the Agreement, or as otherwise may be provided, by Client) which shall include the following provisions on behalf of the Third Party Data licensors, including Her Majesty, Canada Post and NRCan:

The Data may include or reflect data of licensors, including Her Majesty the Queen in the Right of Canada (“Her Majesty”), Canada Post Corporation (“Canada Post”) and the Department of Natural Resources Canada (“NRCan”). Such data is licensed on an “as is” basis. The licensors, including Her Majesty, Canada Post and NRCan, make no guarantees, representations or warranties respecting such data,

# Appendices

---

either express or implied, arising by law or otherwise, including but not limited to, effectiveness, completeness, accuracy or fitness for a particular purpose. The licensors, including Her Majesty, Canada Post and NRCan, shall not be liable in respect of any claim, demand or action, irrespective of the nature of the cause of the claim, demand or action alleging any loss, injury or damages, direct or indirect, which may result from the use or possession of the data or the Data. The licensors, including Her Majesty, Canada Post and NRCan, shall not be liable in any way for loss of revenues or contracts, or any other consequential loss of any kind resulting from any defect in the data or the Data.

End User shall indemnify and save harmless the licensors, including Her Majesty, Canada Post and NRCan, and their officers, employees and agents from and against any claim, demand or action, irrespective of the nature of the cause of the claim, demand or action, alleging loss, costs, expenses, damages or injuries (including injuries resulting in death) arising out of the use or possession of the data or the Data.

4. Additional Provisions: The terms contained in this Section are in addition to all of the rights and obligations of the parties under the Agreement. To the extent that any of the provisions of this Section are inconsistent with, or conflict with, any other provisions of the Agreement, the provisions of this Section shall prevail.

II. Mexico. The following provision applies to the Data for Mexico, which includes certain data from the Instituto Nacional de Estadística y Geografía (“INEGI”):

A. Any and all copies of the Data and/or packaging containing Data for Mexico shall contain the following notice: “Fuente: INEGI (Instituto Nacional de Estadística y Geografía)”

III. Latin America Territory

A. Third Party Notices. Any and all copies of the Data and/or packaging relating thereto shall include the respective Third Party Notices set forth below and used as described below corresponding to the Territory (or portion thereof) included in such copy:

| Territory                                       | Notice   |
|---|--|
| Ecuador   | “INSTITUTO GEOGRAFICO MILITAR DEL ECUADOR AUTORIZACION N° IGM-2011-01- PCO-01 DEL 25 DE ENERO DE 2011”<br>“source: © IGN 2009 - BD TOPO ®” |
| Guadeloupe, French Guiana and Martinique Mexico | “Fuente: INEGI (Instituto Nacional de Estadística y Geografía)”  |

IV. Middle East Territory

# Appendices

---

A. Third Party Notices. Any and all copies of the Data and/or packaging relating thereto shall include the respective Third Party Notices set forth below and used as described below corresponding to the Territory (or portion thereof) included in such copy:

| Country | Notice   |
|---------|--|
| Jordan  | “© Royal Jordanian Geographic Centre”. The foregoing notice requirement for Jordan Data is a material term of the Agreement. If Client or any of its permitted sublicensees (if any) fail to meet such requirement, HERE shall have the right to terminate Client’s license with respect to the Jordan Data. |

B. Jordan Data. Client and its permitted sublicensees (if any) are restricted from licensing and/or otherwise distributing HERE’s database for the country of Jordan (“Jordan Data”) for use in Enterprise Applications to (i) non-Jordanian entities for use of the Jordan Data solely in Jordan or (ii) Jordan-based customers. In addition, Client, its permitted sublicensees (if any) and End-Users are restricted from using the Jordan Data in Enterprise Applications if such party is (i) a non-Jordanian entity using the Jordan Data solely in Jordan or (ii) a Jordan-based customer. For purposes of the foregoing, “Enterprise Applications” shall mean Geomarketing applications, GIS applications, mobile business asset management applications, call center applications, telematics applications, public organization Internet applications or for providing geocoding services.

## V. Europe Territory

### A. Use of Certain Traffic Codes in Europe

1. General Restrictions Applicable to Traffic Codes. Client acknowledges and agrees that in certain countries of the Europe Territory, Client will need to obtain rights directly from third party RDS-TMC code providers to receive and use the Traffic Codes in the Data and to deliver to End-Users Transactions in any way derived from or based on such Traffic Codes. For such countries, HERE shall deliver the Data incorporating Traffic Codes to Client only after receiving certification from Client of its having obtained such rights.

2. Display of Third Party Rights Legends for Belgium. Client shall, for each Transaction that uses Traffic Codes for Belgium, provide the following notice to the End-User: “Traffic Codes for Belgium are provided by the Ministerie van de Vlaamse Gemeenschap and the Ministère de l’Equipeement et des Transports.”

B. Paper Maps. With respect to any license granted to Client relating to making, selling or distributing paper maps (i.e., a map fixed on a paper or paper-like medium): (a) such license with respect to Data for the Territory of Great Britain is conditioned on Client’s entering into and complying with a separate written agreement with the Ordnance Survey (“OS”) to create and sell paper maps, Client’s paying to the OS any and all applicable paper map royalties, and Client’s complying with the OS copyright notice requirements; (b) such license for selling or otherwise distributing for charge with respect to Data for the Territory of Czech Republic

## Appendices

is conditioned on Client's obtaining prior written consent from Kartografie a.s.; (c) such license for selling or distributing with respect to Data for the Territory of Switzerland is conditioned on Client's obtaining a permit from Bundesamt für Landestopografie of Switzerland; (d) Client is restricted from using Data for the Territory of France to create paper maps with a scale between 1:5,000 and 1:250,000; and (e) Client is restricted from using any Data to create, sell or distribute paper maps that are the same or substantially similar, in terms of data content and specific use of color, symbols and scale, to paper maps published by the European national mapping agencies, including without limitation, Landervermessungämter of Germany, Topografische Dienst of the Netherlands, Nationaal Geografisch Instituut of Belgium, Bundesamt für Landestopografie of Switzerland, Bundesamt für Eich- und Vermessungswesen of Austria, and the National Land Survey of Sweden.

C. OS Enforcement. Without limiting Section IV(B) above, with respect to Data for the Territory of Great Britain, Client acknowledges and agrees that the Ordnance Survey ("OS") may bring a direct action against Client to enforce compliance with the OS copyright notice (see Section IV(D) below) and paper map requirements (see Section IV(B) above) contained in this Agreement.

D. Third Party Notices. Any and all copies of the Data and/or packaging relating thereto shall include the respective Third Party Notices set forth below and used as described below corresponding to the Territory (or portion thereof) included in such copy:

Country(ies) Notice

|   |  |
|---|--|
| Austria   | "© Bundesamt für Eich- und Vermessungswesen"   |
| Croatia<br>Cyprus,<br>Estonia,<br>Latvia,<br>Lithuania,<br>Moldova,<br>Poland,<br>Slovenia<br>and/or<br>Ukraine | "© EuroGeographics"  |
| France  | "source: © IGN 2009 – BD TOPO ®"   |
| Germany   | "Die Grundlegendaten wurden mit Genehmigung der zuständigen Behörden entnommen"  |
| Great Britain   | "Contains Ordnance Survey data © Crown copyright and database right 2010 Contains Royal Mail data © Royal Mail copyright and database right 2010"    |
| Greece  | "Copyright Geomatics Ltd."   |
| Hungary   | "Copyright © 2003; Top-Map Ltd."   |
| Italy   | "La Banca Dati Italiana è stata prodotta usando quale riferimento anche cartografia numerica ed al tratto prodotta e fornita dalla Regione Toscana." |
| Norway  | "Copyright © 2000; Norwegian Mapping Authority"  |
| Portugal  | "Source: IgeoE – Portugal"   |

# Appendices

Spain “Información geográfica propiedad del CNIG”

Sweden “Based upon electronic data © National Land Survey Sweden.”

Switzerland “Topografische Grundlage: © Bundesamt für Landestopographie.

E. Respective Country Distribution. Client acknowledges that HERE has not received approvals to distribute map data for the following countries in such respective countries: Albania, Belarus, Kyrgyzstan, Moldova and Uzbekistan. HERE may update such list from time to time. The license rights granted to Client under this TL with respect to the Data for such countries are contingent upon Client’s compliance with all applicable laws and regulations, including, without limitation, any required licenses or approvals to distribute the Application incorporating such Data in such respective countries.

## VI. Australia Territory

A. Third Party Notices. Any and all copies of the Data and/or packaging relating thereto shall include the respective Third Party Notices set forth below and used as described below corresponding to the Territory (or portion thereof) included in such copy:

Copyright. Based on data provided under license from PSMA Australia Limited ([www.pasma.com.au](http://www.pasma.com.au)).

Product incorporates data which is © 20XX Telstra Corporation Limited, GM Holden Limited, Intelomatics Australia Pty Ltd and Continental Pty Ltd.

B. Third Party Notices for Australia. In addition to the foregoing, the End-User Terms for any Application containing RDS-TMC Traffic Codes for Australia shall contain the following notice: “Product incorporates traffic location codes which is © 20XX Telstra Corporation Limited and its licensors.”

## VII. China Territory

### *Personal Use Only*

You agree to use this Data together with [insert name of Client Application] for the solely personal, non-commercial purposes for which you were licensed, and not for service bureau, time-sharing or other similar purposes. Accordingly, but subject to the restrictions set forth in the following paragraphs, you may copy this Data only as necessary for your personal use to (i) view it, and (ii) save it, provided that you do not remove any copyright notices that appear and do not modify the Data in any way. You agree not to otherwise reproduce, copy, modify, decompile, disassemble or reverse engineer any portion of this Data, and may not transfer or distribute it in any form, for any purpose, except to the extent permitted by mandatory laws.

### *Restrictions*

Except where you have been specifically licensed to do so by NAV2 , and without limiting the preceding paragraph, you may not (a) use this Data with any products, systems, or applications installed or otherwise connected to or in communication with vehicles, capable of vehicle navigation, positioning, dispatch, real time route guidance, fleet management or similar applications; or (b)

# Appendices

---

with or in communication with any positioning devices or any mobile or wireless-connected electronic or computer devices, including without limitation cellular phones, palmtop and handheld computers, pagers, and personal digital assistants or PDAs. You agree to cease using this Data if you fail to comply with these terms and conditions.

## **Limited Warranty**

NAV2 warrants that (a) the Data will perform substantially in accordance with the accompanying written materials for a period of ninety (90) days from the date of receipt, and (b) any support services provided by NAV2 shall be substantially as described in applicable written materials provided to you by NAV2, and NAV2's support engineers will make commercially reasonable efforts to solve any problem issues.

## **rigCustomer Remedies**

NAV2 and its suppliers' entire liability and your exclusive remedy shall be, at NAV2's sole discretion, either (a) return of the price paid, if any, or (b) repair or replacement of the Data that do not meet NAV2's Limited Warranty and that are returned to NAV2 with a copy of your receipt. This Limited Warranty is void if failure of the Data has resulted from accident, abuse, or misapplication. Any replacement Data will be warranted for the remainder of the original warranty period or thirty (30) days, whichever is longer. Neither these remedies nor any product support services offered by NAV2 are available without proof of purchase from an authorized international source.

## **No Other Warranty:**

EXCEPT FOR THE LIMITED WARRANTY SET FORTH ABOVE AND TO THE EXTENT PERMITTED BY APPLICABLE LAW, NAV2 AND ITS LICENSORS (INCLUDING THEIR LICENSORS AND SUPPLIERS) DISCLAIM ANY WARRANTIES, EXPRESS OR IMPLIED, OF QUALITY, PERFORMANCE, MERCHANTABILITY, FITNESS FOR A PARTICULAR PURPOSE, OWNERSHIP OR NON-INFRINGEMENT. Certain warranty exclusions may not be permitted under applicable law, so to that extent the above exclusion may not apply to you.

## **Limited Liability:**

TO THE EXTENT PERMITTED BY APPLICABLE LAW, NAV2 AND ITS LICENSORS (INCLUDING THEIR LICENSORS AND SUPPLIERS) SHALL NOT BE LIABLE TO YOU: IN RESPECT OF ANY CLAIM, DEMAND OR ACTION, IRRESPECTIVE OF THE NATURE OF THE CAUSE OF THE CLAIM, DEMAND OR ACTION ALLEGING ANY LOSS, INJURY OR DAMAGES, DIRECT OR INDIRECT, WHICH MAY RESULT FROM THE USE OR POSSESSION OF THE INFORMATION; OR FOR ANY LOSS OF PROFIT, REVENUE, CONTRACTS OR SAVINGS, OR ANY OTHER DIRECT, INDIRECT, INCIDENTAL, SPECIAL OR CONSEQUENTIAL DAMAGES ARISING OUT OF YOUR USE OF OR INABILITY TO USE THIS INFORMATION, ANY DEFECT IN THE INFORMATION, OR THE BREACH OF THESE TERMS OR CONDITIONS, WHETHER IN AN ACTION IN CONTRACT OR TORT OR BASED ON A WARRANTY, EVEN IF NAV2 OR ITS LICENSORS HAVE BEEN ADVISED OF THE POSSIBILITY OF SUCH DAMAGES. UNDER NO CIRCUMSTANCES SHALL NAV2'S OR ITS SUPPLIERS' LIABILITY HEREUNDER EXCEED THE PRICE PAID. Certain liability exclusions may not be permitted under applicable law, so to that extent the above exclusion may not apply to you.

# Appendices

---

## **Export Control**

You agree not to export to anywhere any part of the Data provided to you or any direct product thereof except in compliance with, and with all licenses and approvals required under, applicable export laws, rules and regulations.

## **IP Protection**

The Data are owned by NAV2 or its suppliers and are protected by applicable copyright and other intellectual property law and treaties. The Data are provided solely on the basis of a license to use, not sale.

## **Entire Agreement**

These terms and conditions constitute the entire agreement between NAV2 (and its licensors, including their licensors and suppliers) and you pertaining to the subject matter hereof, and supersedes in their entirety any and all written or oral agreements previously existing between us with respect to such subject matter.

## **Governing Law.**

The above terms and conditions shall be governed by the laws of the People's Republic of China, without giving effect to (i) its conflict of laws provisions, or (ii) the United Nations Convention for Contracts for the International Sale of Goods, which is explicitly excluded. Any dispute arising from or in connection with the Data provided to you hereunder shall be submitted to the Shanghai International Economic and Trade Arbitration Commission for arbitration.

## **Gracenote® Copyright**

CD and music-related data from Gracenote, Inc., copyright© 2000-2007 Gracenote. Gracenote Software, copyright © 2000-2007 Gracenote. This product and service may practice one or more of the following U.S. Patents #5,987,525, #6,061,680, #6,154,773, #6,161,132, #6,230,192, #6,230,207, #6,240,459, #6,330,593 and other patents issued or pending. Some services supplied under license from Open Globe, Inc. for U.S. Patent: #6,304,523.

Gracenote and CDDB are registered trademarks of Gracenote. The Gracenote logo and logotype, and the "Powered by Gracenote™" logo are trademarks of Gracenote.

## **Gracenote® End User License Agreement (EULA)**

This device contains software from Gracenote, Inc. of 2000 Powell Street Emeryville, California 94608 ("Gracenote").

The software from Gracenote (the "Gracenote Software") enables this device to do disc and music file identification and obtain music-related information, including name, artist, track, and title information ("Gracenote Data") from online servers ("Gracenote Servers"), and to perform other functions. You may use Gracenote Data only by means of the intended End User functions of this device.

This device may contain content belonging to Gracenote's providers. If so, all of the restrictions set forth herein with respect to Gracenote Data shall also apply to such content and such content providers shall be entitled to all of the benefits and protections set forth herein that are available to Gracenote.

## Appendices

---

You agree that you will use the content from Gracenote ("Gracenote Content"), Gracenote Data, the Gracenote Software, and Gracenote Servers for your own personal, non-commercial use only. You agree not to assign, copy, transfer or transmit the Gracenote Content, Gracenote Software or any Gracenote Data (except in a Tag associated with a music file) to any third party. YOU AGREE NOT TO USE OR EXPLOIT GRACENOTE CONTENT, GRACENOTE DATA, THE GRACENOTE SOFTWARE, OR GRACENOTE SERVERS, EXCEPT AS EXPRESSLY PERMITTED HEREIN.

You agree that your non-exclusive licenses to use the Gracenote Content, Gracenote Data, the Gracenote Software, and Gracenote Servers will terminate if you violate these restrictions. If your licenses terminate, you agree to cease any and all use of the Gracenote Content, Gracenote Data, the Gracenote Software, and Gracenote Servers. Gracenote, respectively, reserve all rights in Gracenote Data, the Gracenote Software, and the Gracenote Servers and Gracenote Content, including all ownership rights. Under no circumstances will either Gracenote become liable for any payment to you for any information that you provide, including any copyrighted material or music file information. You agree that Gracenote may enforce its respective rights, collectively or separately, under this agreement against you, directly in each company's own name.

Gracenote uses a unique identifier to track queries for statistical purposes. The purpose of a randomly assigned numeric identifier is to allow Gracenote to count queries without knowing anything about who you are. For more information, see the web page at [www.gracenote.com](http://www.gracenote.com) for the Gracenote Privacy Policy.

THE GRACENOTE SOFTWARE, EACH ITEM OF GRACENOTE DATA AND THE GRACENOTE CONTENT ARE LICENSED TO YOU "AS IS". NEITHER GRACENOTE MAKES ANY REPRESENTATIONS OR WARRANTIES, EXPRESS OR IMPLIED, REGARDING THE ACCURACY OF ANY GRACENOTE DATA FROM THE GRACENOTE SERVERS OR GRACENOTE CONTENT. GRACENOTE COLLECTIVELY AND SEPARATELY RESERVE THE RIGHT TO DELETE DATA AND/OR CONTENT FROM THE COMPANIES' RESPECTIVE SERVERS OR, IN THE CASE OF GRACENOTE, CHANGE DATA CATEGORIES FOR ANY CAUSE THAT GRACENOTE DEEMS SUFFICIENT. NO WARRANTY IS MADE THAT EITHER GRACENOTE CONTENT OR THE GRACENOTE SOFTWARE OR GRACENOTE SERVERS ARE ERROR-FREE OR THAT THE FUNCTIONING OF THE GRACENOTE SOFTWARE OR GRACENOTE SERVERS WILL BE UNINTERRUPTED. GRACENOTE IS NOT OBLIGATED TO PROVIDE YOU WITH ANY ENHANCED OR ADDITIONAL DATA TYPES THAT GRACENOTE MAY CHOOSE TO PROVIDE IN THE FUTURE AND IS FREE TO DISCONTINUE ITS ONLINE SERVICES AT ANY TIME. GRACENOTE DISCLAIM ALL WARRANTIES EXPRESS OR IMPLIED, INCLUDING, BUT NOT LIMITED TO, IMPLIED WARRANTIES OF MERCHANTABILITY, FITNESS FOR A PARTICULAR PURPOSE, TITLE, AND NON-INFRINGEMENT. NEITHER GRACENOTE WARRANTS THE RESULTS THAT WILL BE OBTAINED BY YOUR USE OF THE GRACENOTE SOFTWARE OR ANY GRACENOTE SERVER. IN NO CASE WILL GRACENOTE BE LIABLE FOR ANY CONSEQUENTIAL OR INCIDENTAL DAMAGES OR FOR ANY LOST PROFITS OR LOST REVENUES FOR ANY REASON WHATSOEVER.

© Gracenote 2007.



# Appendices

## Vehicle with SYNC only United States and Mexico

FCC ID: KMHSG1G1

IC: 1422A-SG1G1

### Mexico

Model: KMHSG1P1

NOM-121-SCT1-2009

The operation of this equipment is subject to the following two conditions: (1) This equipment or device may not cause harmful interference, and (2) this equipment or device must accept any interference, including interference that may cause undesired operation.

## Vehicle with SYNC with Touchscreen/My Touch

FCC ID: KMHSYNGG2

IC: 1422A-SYNGG2

This device complies with Part 15 of the FCC Rules and with RSS-210 of Industry Canada. Operation is subject to the following two conditions: (1) This device may not cause harmful interference, and (2) this device must accept any interference received, including interference that may cause undesired operation.

### WARNING



Changes or modifications not expressly approved by the party responsible for compliance could void the user's authority to operate the equipment. The term "IC" before the radio certification number only signifies that Industry Canada technical specifications were met.

The antenna used for this transmitter must not be co-located or operating in conjunction with any other antenna or transmitter.

## TYPE APPROVALS

### RF Certification Logos for Tire Pressure Monitoring Sensor(s)

Schrader AG2SZ4 Numero de Registro  
CNC: H-13498

E207816

Argentina

TRA  
REGISTERED NO:ER0130238/14  
DEALER NO:DA0047074/10

E207817

Abu Dhabi, Dubai

MODELO: AG2SZ3  
2109-14-8001  
ANATEL  
(01)0789895330292

E197509

# Appendices



E202555

Brazil



E197811

Moldova

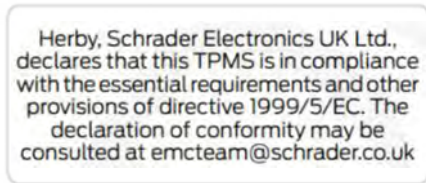

E207818

European Union EU



E207821

Morocco

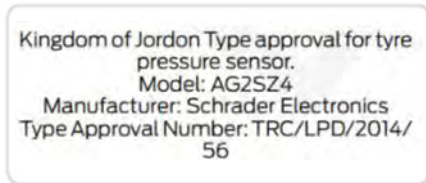

E207819

Jordan



E198001

Philippines



E207820

Malaysia



E197844

Serbia

# Appendices

Complies with  
IDA Standards  
DA 00461

E207822

Singapore



TA-2014/064

Approved

E198002

South Africa



E203899



CCAM14LP0090T3

E203679

Taiwan



Schrader Electronics цім стверджує, що обладнання Радіопередавач моделі AG2S24 системи контролю тиску в шині автомобіля відповідає вимогам Технічного регламенту радіообладнання і телекомунікаційного кінцевого (термінального) обладнання (Постанова КМУ № 679 від 24 червня 2009 р.) Декларация відповідності знаходиться на сайті Schrader

Electronics та надається за запитом на електронну адресу [doc.request@schrader.co.uk](mailto:doc.request@schrader.co.uk)

E198009

Ukraine



# Index

## 1

|   |     |
|---|-----|
| 180 Degree Camera.....                  | 206 |
| Camera Views.....                       | 207 |
| Using the 180 degree camera system..... | 207 |

## 4

|                            |     |
|----------------------------|-----|
| 4WD                        |     |
| See: Four-Wheel Drive..... | 180 |

## A

|  |     |
|--|-----|
| A/C  |     |
| See: Climate Control.....  | 127 |
| About This Manual.....   | 7   |
| ABS  |     |
| See: Brakes.....   | 185 |
| ABS driving hints  |     |
| See: Hints on Driving With Anti-Lock Brakes.....                                     | 185 |
| Accessories.....   | 479 |
| Exterior Style.....  | 479 |
| Interior Style.....  | 479 |
| Lifestyle.....   | 479 |
| Peace of Mind.....   | 479 |
| Accessories  |     |
| See: Replacement Parts Recommendation.....   | 11  |
| ACC  |     |
| See: Using Adaptive Cruise Control.....  | 209 |
| Active Park Assist.....  | 198 |
| Deactivating the Active Park Assist Feature.....                                     | 202 |
| Parallel Parking, Perpendicular Parking, Park Out Assist.....                        | 198 |
| Troubleshooting the System.....  | 202 |
| Adjusting the Headlamps.....   | 289 |
| Vertical Aim Adjustment.....   | 289 |
| Adjusting the Pedals.....  | 75  |
| Adjusting the Steering Wheel - Vehicles With: Manual Adjustable Steering Column..... | 71  |
| Adjusting the Steering Wheel - Vehicles With: Power Adjustable Steering Column.....  | 71  |
| Easy Entry and Exit Feature.....   | 72  |

|   |     |
|---|-----|
| End of Travel Position.....                                       | 72  |
| Memory Feature.....   | 72  |
| Airbag Disposal.....  | 47  |
| Air Conditioning  |     |
| See: Climate Control.....   | 127 |
| Air Filter  |     |
| See: Changing the Engine Air Filter.....                          | 296 |
| Alarm   |     |
| See: Anti-Theft Alarm.....  | 70  |
| Anti-Theft Alarm.....   | 70  |
| Arming the Alarm.....   | 70  |
| Disarming the Alarm.....  | 70  |
| Appendices.....   | 502 |
| Audible Warnings and Indicators.....                              | 98  |
| Automatic Transmission Warning Chime.....                         | 98  |
| Engine On Warning Chime.....                                      | 98  |
| Headlamps On Warning Chime.....                                   | 98  |
| Key in Ignition Warning Chime.....                                | 98  |
| Keyless Warning Alert .....                                       | 98  |
| Parking Brake On Warning Chime.....                               | 98  |
| Audio Control.....  | 72  |
| Seek and Media.....   | 73  |
| Type 1.....   | 72  |
| Type 2.....   | 72  |
| Type 3.....   | 73  |
| Audio System.....   | 351 |
| General Information.....  | 351 |
| Audio Unit - Vehicles With: AM/FM/CD/SYNC.....                    | 352 |
| Audio Unit - Vehicles With: Premium AM/FM/CD.....                 | 355 |
| Audio Unit - Vehicles With: Sony AM/FM/CD.....                    | 356 |
| Menu Structure.....   | 358 |
| Autolamps.....  | 80  |
| Windshield Wiper Activated Headlamps.....                         | 80  |
| Automatic Climate Control - Vehicles With: Premium AM/FM/CD.....  | 128 |
| Automatic Climate Control - Vehicles With: Sony Audio System..... | 130 |
| Automatic High Beam Control.....                                  | 82  |
| Activating the System.....  | 83  |
| Manually Overriding the System.....                               | 83  |
| Automatic Transmission.....                                       | 177 |
| Brake-Shift Interlock.....  | 178 |

# Index

|   |     |
|---|-----|
| If Your Vehicle Gets Stuck In Mud or Snow.....                        | 179 |
| SelectShift Automatic™<br>Transmission.....                           | 177 |
| Understanding the Positions of Your Automatic Transmission.....       | 177 |
| Automatic Transmission Fluid Check - 2.3L EcoBoost™.....              | 283 |
| Automatic Transmission Fluid Check - 3.5L Duratec/3.5L EcoBoost™..... | 284 |
| Adding Transmission Fluid.....  | 285 |
| Checking the Transmission Fluid Level.....                            | 284 |
| Autowipers.....   | 76  |
| Auxiliary Power Points.....   | 159 |
| 110 Volt AC Power Point.....  | 159 |
| 12 Volt DC Power Point.....   | 159 |
| Locations.....  | 159 |
| <b>B</b>  |     |
| Battery<br>See: Changing the 12V Battery.....                         | 286 |
| Blind Spot Information System.....                                    | 219 |
| Switching the System Off and On.....                                  | 222 |
| System Errors.....  | 221 |
| Using the System.....   | 220 |
| Bonnet Lock<br>See: Opening and Closing the Hood.....                 | 273 |
| Booster Seats.....  | 26  |
| Types of Booster Seats.....   | 27  |
| Brake Fluid Check.....  | 285 |
| Brakes.....   | 185 |
| General Information.....  | 185 |
| Breaking-In.....  | 248 |
| Bulb Specification Chart.....   | 294 |
| <b>C</b>  |     |
| Cabin Air Filter.....   | 135 |
| California Proposition 65.....  | 11  |
| Capacities and Specifications - 2.3L EcoBoost™.....                   | 338 |
| Specifications.....   | 338 |
| Capacities and Specifications - 3.5L Duratec.....                     | 341 |
| Specifications.....   | 342 |
| Capacities and Specifications - 3.5L EcoBoost™.....                   | 346 |
| Specifications.....   | 347 |
| Capacities and Specifications.....                                    | 331 |
| Cargo Nets.....   | 229 |
| Car Wash<br>See: Cleaning the Exterior.....                           | 297 |
| Center Console.....   | 161 |
| Rear Seat Armrest.....  | 161 |
| Changing a Bulb.....  | 291 |
| Front Direction Indicator.....  | 291 |
| Front Fog Lamp.....   | 292 |
| Headlamp.....   | 291 |
| Headlamp High Beam.....   | 292 |
| LED Lamps.....  | 293 |
| License Plate Lamp.....   | 294 |
| Rear Direction Indicator and Reversing Lamp.....                      | 293 |
| Changing a Fuse.....  | 271 |
| Fuses.....  | 271 |
| Changing a Road Wheel.....  | 325 |
| Dissimilar Spare Wheel and Tire Assembly Information.....             | 325 |
| Tire Change Procedure.....  | 326 |
| Changing the 12V Battery.....   | 286 |
| Changing the Engine Air Filter.....                                   | 296 |
| Changing the Wiper Blades.....  | 288 |
| Front Wiper Blades.....   | 288 |
| Rear Window Wiper Blade.....  | 289 |
| Checking MyKey System Status.....                                     | 57  |
| Checking the Wiper Blades.....  | 288 |
| Child Restraint and Seatbelt Maintenance.....                         | 38  |
| Child Restraint Positioning.....                                      | 28  |
| Child Safety.....   | 15  |
| General Information.....  | 15  |
| Child Safety Locks.....   | 29  |
| Left-Hand Side.....   | 30  |
| Right-Hand Side.....  | 30  |
| Child Seats.....  | 16  |
| Cleaning Leather Seats.....   | 301 |
| Cleaning Products.....  | 297 |
| Cleaning the Alloy Wheels.....  | 301 |
| Cleaning the Engine.....  | 299 |
| Cleaning the Exterior.....  | 297 |
| Exterior Chrome Parts.....  | 298 |
| Exterior Plastic Parts.....   | 298 |
| Stripes or Graphics.....  | 298 |

# Index

|   |     |  |     |
|---|-----|--|-----|
| Underbody.....  | 298 | Direction Indicators.....                                    | 84  |
| Under Hood.....   | 298 | Driver Alert.....  | 215 |
| Cleaning the Instrument Panel and<br>Instrument Cluster Lens..... | 300 | PRINCIPLE OF OPERATION.....                                  | 215 |
| Cleaning the Interior.....  | 300 | USING DRIVER ALERT.....                                      | 215 |
| Cleaning the Windows and Wiper<br>Blades.....                     | 299 | Driver and Passenger Airbags.....                            | 41  |
| Clearing All MyKeys.....  | 56  | Children and Airbags.....                                    | 41  |
| Climate.....  | 460 | Proper Driver and Front Passenger Seating<br>Adjustment..... | 41  |
| Climate Control Voice Commands.....                               | 463 | Driving Aids.....  | 215 |
| Climate Control.....  | 127 | Driving Hints.....   | 248 |
| Climate Controlled Seats.....                                     | 152 | Driving Through Water.....                                   | 249 |
| Cooled Seats.....   | 152 | DRL  |     |
| Heated Seats.....   | 152 | See: Daytime Running Lamps.....                              | 81  |
| Coolant Check   |     |  |     |
| See: Engine Coolant Check.....                                    | 280 |  |     |
| Crash Sensors and Airbag Indicator.....                           | 46  | <b>E</b>   |     |
| Creating a MyKey.....   | 55  | Economical Driving.....                                      | 248 |
| Programming/Changing Configurable<br>Settings.....                | 55  | Emission Control System.....                                 | 174 |
| Cross Traffic Alert.....  | 222 | On-Board Diagnostics (OBD-II).....                           | 175 |
| False Alerts.....   | 225 | Readiness for Inspection/Maintenance<br>(I/M) Testing.....   | 175 |
| Switching the System Off and On.....                              | 225 | End User License Agreement.....                              | 502 |
| System Errors.....  | 225 | SYNC End User License Agreement<br>(EULA).....               | 502 |
| System Lights, Messages and Audible<br>Alerts.....                | 224 | Engine Block Heater.....                                     | 166 |
| System Limitations.....   | 224 | Using the Engine Block Heater.....                           | 167 |
| Using the System.....   | 222 | Engine Coolant Check.....                                    | 280 |
| Cruise Control.....   | 73  | Adding Engine Coolant.....                                   | 280 |
| Principle of Operation.....                                       | 208 | Checking the Engine Coolant.....                             | 280 |
| Type 1.....   | 73  | Recycled Engine Coolant.....                                 | 281 |
| Type 2.....   | 74  | Severe Climates.....   | 281 |
| Cruise control  |     | What You Should Know About Fail-Safe<br>Cooling.....         | 282 |
| See: Using Cruise Control.....                                    | 208 | Engine Immobilizer   |     |
| Customer Assistance.....  | 256 | See: Passive Anti-Theft System.....                          | 69  |
| <b>D</b>  |     | Engine Oil Check.....  | 278 |
| Data Recording.....   | 9   | Adding Engine Oil.....                                       | 278 |
| Event Data Recording.....   | 9   | Engine Oil Dipstick - 2.3L                                   |     |
| Service Data Recording.....                                       | 9   | EcoBoost™.....   | 278 |
| Daytime Running Lamps.....  | 81  | Engine Oil Dipstick - 3.5L Duratec/3.5L<br>EcoBoost™.....    | 278 |
| Type 1 - Conventional   |     | Engine Specifications - 2.3L                                 |     |
| (Non-Configurable).....   | 82  | EcoBoost™.....   | 331 |
| Type 2 - Configurable.....  | 82  | Drivebelt Routing.....                                       | 331 |
| Digital Radio.....  | 360 | Engine Specifications - 3.5L                                 |     |
| HD Radio Reception and Station<br>Troubleshooting.....            | 361 | Duratec.....   | 332 |
|   |     | Drivebelt Routing.....                                       | 332 |

# Index

|   |     |
|---|-----|
| Engine Specifications - 3.5L                                |     |
| EcoBoost™   | 332 |
| Drivebelt Routing   | 333 |
| Entertainment   | 427 |
| AM/FM Radio   | 428 |
| Bluetooth Audio   | 442 |
| CD  | 438 |
| SD Card Slot and USB Port                                   | 439 |
| SIRIUS® Satellite Radio (If Activated)                      | 433 |
| Supported Media Players, Formats and Metadata Information   | 442 |
| Environmental   | 14  |
| Essential Towing Checks                                     | 242 |
| Before Towing a Trailer                                     | 243 |
| Hitches   | 242 |
| Launching or Retrieving a Boat or Personal Watercraft (PWC) | 244 |
| Safety Chains   | 242 |
| Trailer Brakes  | 243 |
| Trailer Lamps   | 243 |
| When Towing a Trailer                                       | 243 |
| Event Data Recording  |     |
| See: Data Recording   | 9   |
| Export Unique Options                                       | 13  |
| Extended Service Plan (ESP)                                 | 481 |
| EXTENDED SERVICE PLAN (CANADA ONLY)                         | 482 |
| EXTENDED SERVICE PLAN (U.S. Only)                           | 481 |
| Exterior Mirrors  | 87  |
| Auto-dimming Feature  | 88  |
| Auto-Folding Mirrors  | 87  |
| Blind Spot Information System                               | 89  |
| Direction Indicator Mirrors                                 | 88  |
| Fold-Away Exterior Mirrors                                  | 87  |
| Heated Exterior Mirrors                                     | 88  |
| Integrated Blind Spot Mirror                                | 88  |
| Memory Mirrors  | 88  |
| Power Exterior Mirrors                                      | 87  |
| <b>F</b>  |     |
| Fastening the Seatbelts                                     | 32  |
| Rear Inflatable Safety Belt                                 | 34  |
| Safety Belt Extension Assembly                              | 35  |
| Safety Belt Locking Modes                                   | 33  |
| Using Safety Belts During Pregnancy                         | 32  |
| Floor Mats  | 249 |
| Fog Lamps - Front   |     |
| See: Front Fog Lamps  | 83  |
| Foot Pedals   |     |
| See: Adjusting the Pedals                                   | 75  |
| Ford Credit   | 11  |
| US Only   | 11  |
| Four-Wheel Drive  | 180 |
| Principle of Operation                                      | 180 |
| Front Fog Lamps   | 83  |
| Front Parking Aid   | 195 |
| Obstacle Distance Indicator                                 | 196 |
| Front Passenger Sensing System                              | 42  |
| Fuel and Refueling  | 168 |
| Fuel Consumption  | 173 |
| Calculating Fuel Economy                                    | 173 |
| Filling the Fuel Tank                                       | 173 |
| Fuel Filler Funnel Location                                 | 170 |
| Fuel Filter   | 286 |
| Fuel Quality - E85  | 169 |
| Choosing the Right Fuel - Flex Fuel Vehicles                | 169 |
| Fuel Quality  | 169 |
| Choosing the Right Fuel                                     | 169 |
| Fuel Shutoff  | 252 |
| Fuses   | 263 |
| Fuse Specification Chart                                    | 263 |
| Passenger Compartment Fuse Panel                            | 268 |
| Power Distribution Box                                      | 263 |
| <b>G</b>  |     |
| Garage Door Opener  |     |
| See: Universal Garage Door Opener                           | 154 |
| Gauges  | 91  |
| Engine Coolant Temperature Gauge                            | 94  |
| Fuel Gauge  | 94  |
| Information Display   | 93  |
| Type 1  | 91  |
| Type 2  | 92  |
| Type 3  | 93  |
| General Information on Radio                                |     |
| Frequencies   | 48  |
| Intelligent Access  | 48  |
| General Maintenance Information                             | 483 |
| Multi-Point Inspection                                      | 485 |
| Owner Checks and Services                                   | 484 |



# Index

|   |     |
|---|-----|
| Protecting Your Investment.....                               | 483 |
| Why Maintain Your Vehicle?.....                               | 483 |
| Why Maintain Your Vehicle at Your<br>Dealership?.....         | 483 |
| Getting Assistance Outside the U.S. and<br>Canada.....        | 259 |
| Getting the Services You Need.....                            | 256 |
| Away From Home.....   | 256 |
| <b>H</b>  |     |
| Handbrake   |     |
| See: Parking Brake.....                                       | 186 |
| Hazard Warning Flashers.....                                  | 252 |
| HDC   |     |
| See: Using Hill Descent Control.....                          | 192 |
| Headlamp Adjusting  |     |
| See: Adjusting the Headlamps.....                             | 289 |
| Headlamp Exit Delay.....                                      | 81  |
| Headlamp Removal  |     |
| See: Removing a Headlamp.....                                 | 291 |
| Head Restraints.....  | 137 |
| Adjusting the Head Restraint.....                             | 138 |
| Tilting Head Restraints .....                                 | 139 |
| Heated Seats.....   | 151 |
| Front Seats.....  | 151 |
| Second Row Heated Seats.....                                  | 151 |
| Heated Steering Wheel.....                                    | 74  |
| Heated Windows and Mirrors.....                               | 135 |
| Heated Exterior Mirror.....                                   | 135 |
| Heated Rear Window.....                                       | 135 |
| Heating   |     |
| See: Climate Control.....                                     | 127 |
| Hill Start Assist.....  | 186 |
| Switching the System On and Off.....                          | 187 |
| Using Hill Start Assist.....                                  | 186 |
| Hints on Controlling the Interior                             |     |
| Climate.....  | 132 |
| Cooling the Interior Quickly.....                             | 133 |
| General Hints.....  | 132 |
| Heating the Interior Quickly.....                             | 132 |
| Recommended Settings for Cooling.....                         | 133 |
| Recommended Settings for Heating.....                         | 133 |
| Side Window Defogging in Cold<br>Weather.....                 | 134 |
| Hints on Driving With Anti-Lock<br>Brakes.....                | 185 |
| Hood Lock   |     |
| See: Opening and Closing the Hood.....                        | 273 |
| <b>I</b>  |     |
| Ignition Switch.....  | 162 |
| In California (U.S. Only).....                                | 257 |
| Information Display Control.....                              | 74  |
| Information Displays.....                                     | 99  |
| General Information.....                                      | 99  |
| Information.....  | 450 |
| 911 Assist.....   | 457 |
| Alerts.....   | 456 |
| Calendar.....   | 456 |
| Sirius Travel Link.....                                       | 455 |
| SYNC Services (If Equipped, United States<br>Only).....       | 451 |
| Vehicle Health Report (If Equipped, US<br>Only).....          | 459 |
| Information Messages.....                                     | 113 |
| 4WD.....  | 113 |
| Adaptive Cruise Control.....                                  | 114 |
| AdvanceTrac™.....   | 114 |
| Alarm.....  | 114 |
| Automatic Engine Shutdown.....                                | 115 |
| Automatic High Beam Control.....                              | 115 |
| Battery and Charging System.....                              | 116 |
| Blind Spot Information and Cross Traffic<br>Alert System..... | 116 |
| Brake System.....   | 117 |
| Collision Warning System.....                                 | 117 |
| Doors and Locks.....  | 117 |
| Driver Alert.....   | 118 |
| Electronic Stability Control.....                             | 118 |
| Engine.....   | 118 |
| Fuel.....   | 119 |
| Hill Descent Control.....                                     | 119 |
| Hill Start Assist.....  | 119 |
| Keys and Intelligent Access.....                              | 120 |
| Lane Keeping System.....                                      | 121 |
| Maintenance.....  | 121 |
| MyKey.....  | 122 |
| Park Aid.....   | 122 |
| Park Brake.....   | 122 |
| Power Steering.....   | 123 |
| Pre-Collision Warning System.....                             | 123 |
| Remote Start.....   | 123 |
| Seats.....  | 124 |

# Index

|                                      |     |  |     |
|--------------------------------------|-----|--|-----|
| Starting System.....                 | 124 | Lighting Control.....                      | 79  |
| Terrain Management System.....       | 125 | Headlamp Flasher.....                      | 80  |
| Tire Pressure Monitoring System..... | 124 | High Beam.....                             | 79  |
| Traction Control.....                | 125 | Lighting.....                              | 79  |
| Trailer.....                         | 125 | General Information.....                   | 79  |
| Transmission.....                    | 126 | Load Carriers                              |     |
| Installing Child Restraints.....     | 17  | See: Roof Racks and Load Carriers.....     | 230 |
| Using Lap and Shoulder Belts.....    | 17  | Load Carrying.....                         | 229 |
| Using Lower Anchors and Tethers for  |     | Load Limit.....                            | 231 |
| Children (LATCH).....                | 22  | Special Loading Instructions for Owners of |     |
| Using Tether Straps.....             | 24  | Pick-up Trucks and Utility-type            |     |
| Instrument Cluster.....              | 91  | Vehicles.....                              | 238 |
| Instrument Lighting Dimmer.....      | 81  | Vehicle Loading - with and without a       |     |
| Interior Lamps.....                  | 84  | Trailer.....                               | 231 |
| Battery Saver.....                   | 85  | Locking and Unlocking.....                 | 60  |
| Dome Lamp.....                       | 84  | Activating Intelligent Access.....         | 60  |
| Front Row Map Lamps.....             | 84  | Autolock.....                              | 62  |
| Second Row Dome and Courtesy         |     | Autounlock .....                           | 62  |
| Lamps.....                           | 85  | Battery Saver.....                         | 62  |
| Second Row Dome and Map Lamps.....   | 85  | Enabling or Disabling Autolock and         |     |
| Third Row Cargo Lamp.....            | 85  | Autounlock.....                            | 62  |
| Interior Mirror.....                 | 89  | Illuminated Entry.....                     | 62  |
| Auto-Dimming Mirror.....             | 89  | Illuminated Exit.....                      | 62  |
| Introduction.....                    | 7   | Locking and Unlocking the Doors with the   |     |
| <b>J</b>                             |     | Key Blade.....                             | 60  |
| Jump Starting the Vehicle.....       | 253 | Power Door Locks.....                      | 60  |
| Connecting the Jumper Cables.....    | 253 | Remote Control.....                        | 60  |
| Jump Starting.....                   | 254 | Smart Unlocks for Integrated Keyhead       |     |
| Preparing Your Vehicle.....          | 253 | Transmitter.....                           | 61  |
| Removing the Jumper Cables.....      | 254 | Smart Unlocks for Intelligent Access       |     |
| <b>K</b>                             |     | Keys.....                                  | 61  |
| Keyless Entry.....                   | 67  | Locks.....                                 | 60  |
| SECURICODE™ Keyless Entry            |     | Luggage Covers.....                        | 230 |
| Keypad.....                          | 67  | Lug Nuts                                   |     |
| Keyless Starting.....                | 162 | See: Changing a Road Wheel.....            | 325 |
| Ignition Modes.....                  | 163 | <b>M</b>                                   |     |
| Keys and Remote Controls.....        | 48  | Maintenance.....                           | 273 |
| Principle of Operation.....          | 48  | General Information.....                   | 273 |
| <b>L</b>                             |     | Manual Climate Control.....                | 127 |
| Lane Keeping System.....             | 215 | Manual Liftgate.....                       | 63  |
| Switching the System On and Off..... | 216 | Closing the Liftgate.....                  | 63  |
|                                      |     | Opening the Liftgate.....                  | 63  |
|                                      |     | Manual Seats.....                          | 140 |
|                                      |     | Lumbar Adjustment.....                     | 141 |
|                                      |     | Moving the Seat Backward and               |     |
|                                      |     | Forward.....                               | 140 |

# Index

|   |     |
|---|-----|
| Recline Adjustment.....   | 140 |
| Media Hub.....  | 365 |
| Memory Function.....  | 143 |
| Easy Entry and Exit Feature.....  | 144 |
| Linking a PreSet Position to your Remote Control or Intelligent Access Key Fob..... | 144 |
| Saving a PreSet Position.....   | 143 |
| Message Center  |     |
| See: Information Displays.....  | 99  |
| Mirrors   |     |
| See: Heated Windows and Mirrors.....  | 135 |
| See: Windows and Mirrors.....   | 86  |
| Mobile Communications Equipment.....  | 13  |
| Moonroof.....   | 90  |
| Bounce-Back.....  | 90  |
| Opening and Closing the Moonroof.....   | 90  |
| Opening and Closing the Sunscreen.....  | 90  |
| Venting the Moonroof.....   | 90  |
| Motorcraft Parts - 2.3L   |     |
| EcoBoost™.....  | 333 |
| Motorcraft Parts - 3.5L Duratec.....  | 334 |
| Motorcraft Parts - 3.5L   |     |
| EcoBoost™.....  | 335 |
| MyFord Touch™.....  | 404 |
| General Information.....  | 404 |
| MyFord Touch™ Troubleshooting.....  | 472 |
| MyKey Troubleshooting.....  | 58  |
| MyKey™.....   | 54  |
| Principle of Operation.....   | 54  |

## N

|  |     |
|--|-----|
| Navigation.....                          | 464 |
| cityseekr.....                           | 465 |
| Destination Mode.....                    | 464 |
| Map Mode.....                            | 469 |
| Navigation Map Updates.....              | 472 |
| Navigation Voice Commands.....           | 472 |
| Points of Interest (POI) Categories..... | 465 |
| Quick-touch Buttons.....                 | 471 |
| Setting Your Navigation Preferences..... | 466 |
| Normal Scheduled Maintenance.....        | 486 |
| Intelligent Oil-Life Monitor™.....       | 486 |
| Normal Maintenance Intervals.....        | 487 |

## O

|   |     |
|---|-----|
| Oil Change Indicator Reset.....             | 279 |
| Oil Check                                   |     |
| See: Engine Oil Check.....                  | 278 |
| Opening and Closing the Hood.....           | 273 |
| Closing the Hood.....                       | 274 |
| Opening the Hood.....                       | 273 |
| Ordering Additional Owner's Literature..... | 260 |
| Obtaining a French Owner's Manual.....      | 261 |
| Overhead Console.....                       | 161 |

## P

|   |     |
|---|-----|
| Parking Aids.....                               | 194 |
| Principle of Operation.....                     | 194 |
| Parking Brake.....                              | 186 |
| Passenger Knee Airbag.....                      | 45  |
| Passive Anti-Theft System.....                  | 69  |
| SecuriLock®.....                                | 69  |
| PATS  |     |
| See: Passive Anti-Theft System.....             | 69  |
| Pedals.....                                     | 75  |
| Perchlorate.....                                | 11  |
| Personal Safety System™.....                    | 39  |
| How Does the Personal Safety System Work?.....  | 39  |
| Phone.....                                      | 443 |
| Making Calls.....                               | 445 |
| Pairing Subsequent Cell Phones.....             | 444 |
| Pairing Your Cell Phone for the First Time..... | 444 |
| Phone Menu Options.....                         | 446 |
| Phone Settings.....                             | 449 |
| Phone Voice Commands.....                       | 450 |
| Receiving Calls.....                            | 445 |
| Text Messaging.....                             | 447 |
| Post-Crash Alert System.....                    | 255 |
| Power Door Locks                                |     |
| See: Locking and Unlocking.....                 | 60  |
| Power Liftgate.....                             | 64  |
| Hands-Free Feature.....                         | 66  |
| Obstacle Detection.....                         | 66  |
| Opening and Closing the Liftgate.....           | 64  |
| Setting the Liftgate Open Height.....           | 65  |
| Stopping the Liftgate Movement.....             | 65  |

# Index

|  |     |  |     |
|--|-----|--|-----|
| Power Seats.....                                   | 141 | Removing a Headlamp.....   | 291 |
| Multi-Contour Front Seats With Active Motion ..... | 142 | Repairing Minor Paint Damage.....                                    | 301 |
| Power Lumbar.....                                  | 142 | Replacement Parts  |     |
| Power Steering Fluid Check.....                    | 286 | Recommendation.....  | 11  |
| Power Windows.....                                 | 86  | Collision Repairs.....   | 11  |
| Accessory Delay.....                               | 86  | Scheduled Maintenance and Mechanical Repairs.....                    | 11  |
| Bounce-Back.....                                   | 86  | Warranty on Replacement Parts.....                                   | 12  |
| One-Touch Down.....                                | 86  | Replacing a Lost Key or Remote Control.....                          | 53  |
| One-Touch Up.....                                  | 86  | Reporting Safety Defects (Canada Only).....                          | 261 |
| Window Lock.....                                   | 86  | Reporting Safety Defects (U.S. Only).....                            | 261 |
| Pre-Collision Assist.....                          | 226 | Roadside Assistance.....   | 251 |
| Using the Pre-Collision Assist System.....         | 227 | Vehicles Sold in Canada: Getting Roadside Assistance.....            | 251 |
| Protecting the Environment.....                    | 14  | Vehicles Sold in Canada: Roadside Assistance Program Coverage.....   | 252 |
| <b>R</b>   |     | Vehicles Sold in Canada: Using Roadside Assistance.....              | 252 |
| Rear Parking Aid.....                              | 194 | Vehicles Sold in the United States: Getting Roadside Assistance..... | 251 |
| Obstacle Distance Indicator.....                   | 195 | Vehicles Sold in the United States: Using Roadside Assistance.....   | 251 |
| Rear Passenger Climate Controls.....               | 134 | Roadside Emergencies.....  | 251 |
| Rear Seats.....                                    | 144 | Roof Racks and Load Carriers.....                                    | 230 |
| Adjusting the Rear Seats.....                      | 144 | Adjusting the Crossbar.....  | 231 |
| Rear Under Floor Storage.....                      | 229 | Thumbwheel Kit.....  | 230 |
| Adjustable Load Floor.....                         | 229 | Running-In   |     |
| Cargo Management System.....                       | 229 | See: Breaking-In.....  | 248 |
| Rear View Camera.....                              | 203 | Running Out of Fuel.....   | 170 |
| Using the Rear View Camera System.....             | 204 | Adding Fuel From a Portable Fuel Container.....                      | 170 |
| Rear View Camera                                   |     | Filling a Portable Fuel Container.....                               | 170 |
| See: Rear View Camera.....                         | 203 | <b>S</b>   |     |
| Rear Window Wiper and Washers.....                 | 77  | Safety Canopy™.....  | 45  |
| Rear Camera Washer.....                            | 78  | Safety Precautions.....  | 168 |
| Rear Window Washer.....                            | 78  | Satellite Radio.....   | 362 |
| Rear Window Wiper.....                             | 77  | Satellite Radio Electronic Serial Number (ESN).....                  | 363 |
| Recommended Towing Weights.....                    | 240 | Satellite Radio Reception Factors.....                               | 363 |
| Refueling.....                                     | 171 | SIRIUS® Satellite Radio Service.....                                 | 363 |
| Easy Fuel™ Capless Fuel System.....                | 172 | Troubleshooting.....   | 364 |
| Remote Control.....                                | 49  | Scheduled Maintenance Record.....                                    | 491 |
| Car Finder.....                                    | 52  | Scheduled Maintenance.....   | 483 |
| Integrated Keyhead Transmitters .....              | 49  |  |     |
| Intelligent Access Key.....                        | 49  |  |     |
| Memory Feature.....                                | 51  |  |     |
| Remote Start.....                                  | 52  |  |     |
| Replacing the Battery.....                         | 50  |  |     |
| Sounding a Panic Alarm.....                        | 52  |  |     |
| Remote Start.....                                  | 136 |  |     |
| Automatic Settings.....                            | 136 |  |     |

# Index

|  |     |
|--|-----|
| Seatbelt Height Adjustment.....  | 36  |
| Seatbelt Reminder.....   | 37  |
| Belt-Minder™.....  | 37  |
| Seatbelts.....   | 31  |
| Principle of Operation.....  | 31  |
| Seatbelt Warning Lamp and Indicator                                    |     |
| Chime.....   | 36  |
| Conditions of operation.....   | 36  |
| Seats.....   | 137 |
| Security.....  | 69  |
| Settings.....  | 414 |
| Clock.....   | 415 |
| Display.....   | 415 |
| Settings.....  | 419 |
| Sound.....   | 417 |
| Vehicle.....   | 417 |
| Side Airbags.....  | 44  |
| Side Sensing System.....   | 196 |
| Obstacle Distance Indicator.....                                       | 197 |
| Sitting in the Correct Position.....                                   | 137 |
| Snow Chains  |     |
| See: Using Snow Chains.....  | 320 |
| Special Notices.....   | 12  |
| New Vehicle Limited Warranty.....                                      | 12  |
| Notice to Owners of Pickup Trucks and<br>Utility Type Vehicles.....    | 12  |
| On Board Diagnostics Data Link<br>Connector.....                       | 12  |
| Special Instructions.....  | 12  |
| Using Your Vehicle as an Ambulance.....                                | 13  |
| Using Your Vehicle With a Snowplow.....                                | 13  |
| Special Operating Conditions Scheduled<br>Maintenance.....             | 489 |
| Exceptions.....  | 490 |
| Speed Control  |     |
| See: Cruise Control.....   | 208 |
| Stability Control.....   | 189 |
| Principle of Operation.....  | 189 |
| Starter Switch   |     |
| See: Ignition Switch.....  | 162 |
| Starting a Gasoline Engine.....  | 163 |
| Automatic Engine Shutdown.....   | 165 |
| Failure to Start.....  | 164 |
| Guarding Against Exhaust Fumes.....                                    | 166 |
| Important Ventilating Information.....                                 | 166 |
| Stopping the Engine When Your Vehicle is<br>Moving.....                | 165 |
| Stopping the Engine When Your Vehicle is<br>Stationary.....            | 165 |
| Vehicles with an Ignition Key.....                                     | 163 |
| Vehicles with Keyless Start.....                                       | 163 |
| Starting and Stopping the Engine.....                                  | 162 |
| General Information.....   | 162 |
| Steering.....  | 225 |
| Electric Power Steering.....   | 225 |
| Steering Wheel.....  | 71  |
| Storage Compartments.....  | 161 |
| Sunroof  |     |
| See: Moonroof.....   | 90  |
| Sun Visors.....  | 89  |
| Illuminated Vanity Mirror.....   | 89  |
| Supplementary Restraints System.....                                   | 40  |
| Principle of Operation.....  | 40  |
| Symbols Glossary.....  | 7   |
| SYNC™ Applications and<br>Services.....                                | 382 |
| 911 Assist.....  | 382 |
| SYNC Mobile Apps.....  | 384 |
| SYNC™.....   | 366 |
| General Information.....   | 366 |
| SYNC™ Troubleshooting.....   | 396 |
| <b>T</b>   |     |
| Tailgate   |     |
| See: Manual Liftgate.....  | 63  |
| See: Power Liftgate.....   | 64  |
| Technical Specifications   |     |
| See: Capacities and Specifications.....                                | 331 |
| Terrain Response.....  | 191 |
| The Better Business Bureau (BBB) Auto<br>Line Program (U.S. Only)..... | 258 |
| Tire Care.....   | 307 |
| Glossary of Tire Terminology.....                                      | 308 |
| Information About Uniform Tire Quality<br>Grading.....                 | 307 |
| Information Contained on the Tire<br>Sidewall.....                     | 309 |
| Temperature A B C.....   | 308 |
| Traction AA A B C.....   | 307 |
| Treadwear.....   | 307 |
| Tire Pressure Monitoring System.....                                   | 321 |
| Changing Tires With a Tire Pressure<br>Monitoring System.....          | 322 |

# Index

|  |     |
|--|-----|
| Understanding Your Tire Pressure Monitoring System .....           | 323 |
| <b>Tires</b>   |     |
| See: Wheels and Tires.....   | 304 |
| Towing a Trailer.....  | 239 |
| Load Placement.....  | 239 |
| Towing the Vehicle on Four Wheels -                                |     |
| 2.3L EcoBoost™.....  | 245 |
| Emergency Towing.....  | 245 |
| Recreational Towing.....   | 245 |
| Towing the Vehicle on Four Wheels -                                |     |
| 3.5L Duratec/3.5L Ecoboost™.....                                   | 246 |
| Emergency Towing.....  | 246 |
| Recreational Towing.....   | 246 |
| Towing.....  | 239 |
| Traction Control.....  | 188 |
| Principle of Operation.....  | 188 |
| Trailer Sway Control.....  | 240 |
| Transmission Code Designation.....                                 | 337 |
| Transmission.....  | 177 |
| Transmission.....  | 177 |
| See: Transmission.....   | 177 |
| Transporting the Vehicle.....                                      | 244 |
| Type Approvals.....  | 523 |
| RF Certification Logos for Tire Pressure Monitoring Sensor(s)..... | 523 |
| <b>U</b>   |     |
| Under Hood Overview - 2.3L EcoBoost™.....                          | 275 |
| Under Hood Overview - 3.5L Duratec.....                            | 277 |
| Under Hood Overview - 3.5L EcoBoost™.....                          | 276 |
| Universal Garage Door Opener.....                                  | 154 |
| HomeLink Wireless Control System.....                              | 154 |
| USB Port.....  | 365 |
| Using Adaptive Cruise Control.....                                 | 209 |
| Automatic Cancellation.....  | 212 |
| Blocked Sensor.....  | 213 |
| Canceling the Set Speed.....                                       | 211 |
| Changing the Set Speed.....  | 212 |
| Detection Issues.....  | 212 |
| Following a Vehicle.....   | 210 |
| Hilly Condition Usage.....   | 212 |
| Overriding the System.....   | 211 |
| Resuming the Set Speed.....  | 212 |
| Setting the Adaptive Cruise Speed.....                             | 210 |
| Setting the Gap Distance.....                                      | 210 |
| Switching Adaptive Cruise Control Off.....                         | 212 |
| Switching Adaptive Cruise Control On.....                          | 209 |
| Switching to Normal Cruise Control.....                            | 214 |
| System Not Available.....  | 213 |
| Using Cruise Control.....  | 208 |
| Switching Cruise Control Off.....                                  | 209 |
| Switching Cruise Control On.....                                   | 208 |
| Using Four-Wheel Drive.....  | 180 |
| Driving In Special Conditions With Four-Wheel Drive (4WD).....     | 181 |
| How Your Vehicle Differs From Other Vehicles.....                  | 181 |
| Using Hill Descent Control.....                                    | 192 |
| Principle of operation.....  | 192 |
| Using hill descent control.....                                    | 192 |
| Using MyKey With Remote Start Systems.....                         | 58  |
| Using Snow Chains.....   | 320 |
| Using Stability Control.....                                       | 190 |
| AdvanceTrac® with Roll Stability Control™ (RSC®).....              | 190 |
| Using Summer Tires.....  | 320 |
| Using SYNC™ With Your Media Player.....                            | 387 |
| Accessing Your USB Song Library.....                               | 391 |
| Bluetooth Devices and System Settings.....                         | 393 |
| Connecting Your Digital Media Player to the USB Port.....          | 387 |
| Media Menu Features.....   | 391 |
| Media Voice Commands.....  | 388 |
| USB 2.....   | 393 |
| Voice Commands for Audio Sources.....                              | 394 |
| Using SYNC™ With Your Phone.....                                   | 370 |
| Accessing Features through the Phone Menu.....                     | 375 |
| Accessing Your Phone Settings.....                                 | 378 |
| Bluetooth Devices.....   | 379 |
| Making Calls.....  | 373 |
| Pairing a Phone for the First Time.....                            | 370 |
| Pairing Subsequent Phones.....                                     | 371 |
| Phone Options during an Active Call.....                           | 374 |
| Phone Voice Commands.....  | 372 |
| Receiving Calls.....   | 374 |

# Index

|   |     |                                     |     |
|---|-----|-------------------------------------|-----|
| System Settings.....  | 380 | Cruise Control.....                 | 95  |
| Text Messaging.....   | 376 | Direction Indicator.....            | 95  |
| Using Terrain Response.....                                       | 191 | Door Ajar.....                      | 95  |
| Using Traction Control.....                                       | 188 | Engine Coolant Temperature.....     | 95  |
| Switching the System Off.....                                     | 188 | Engine Oil.....                     | 96  |
| System Indicator Lights and<br>Messages.....                      | 188 | Fasten Safety Belt.....             | 96  |
| Using a Switch.....   | 188 | Front Airbag.....                   | 96  |
| Using the Information Display<br>Controls.....                    | 188 | Front Fog Lamps.....                | 96  |
| Using Voice Recognition.....                                      | 368 | Heads Up Display.....               | 96  |
| Initiating a Voice Session.....                                   | 368 | High Beam.....                      | 96  |
| System Interaction and Feedback.....                              | 369 | Hood Ajar.....                      | 96  |
| Utilizing the Mediation/Arbitration<br>Program (Canada Only)..... | 259 | Lane Keeping Aid.....               | 96  |
| <b>V</b>  |     | Liftgate Ajar.....                  | 96  |
| Vehicle Care.....   | 297 | Low Fuel Level.....                 | 96  |
| General Information.....  | 297 | Low Tire Pressure Warning.....      | 96  |
| Vehicle Certification Label.....                                  | 337 | Low Washer Fluid.....               | 97  |
| Vehicle Identification Number.....                                | 336 | Parking Lamps.....                  | 97  |
| Vehicle Storage.....  | 302 | Powertrain Fault.....               | 97  |
| Battery.....  | 303 | Service Engine Soon.....            | 97  |
| Body.....   | 302 | Stability Control.....              | 97  |
| Brakes.....   | 303 | Stability Control Off.....          | 97  |
| Cooling system.....   | 303 | Transmission Tow/Haul.....          | 97  |
| Engine.....   | 302 | Washer Fluid Check.....             | 286 |
| Fuel system.....  | 303 | <b>Washers</b>                      |     |
| General.....  | 302 | See: Cleaning the Exterior.....     | 297 |
| Miscellaneous.....  | 303 | See: Wipers and Washers.....        | 76  |
| Removing Vehicle From Storage.....                                | 303 | <b>Waxing.....</b>                  | 298 |
| Tires.....  | 303 | <b>Wheel Nuts</b>                   |     |
| <b>Ventilation</b>  |     | See: Changing a Road Wheel.....     | 325 |
| See: Climate Control.....   | 127 | <b>Wheels and Tires.....</b>        | 304 |
| <b>VIN</b>  |     | General Information.....            | 304 |
| See: Vehicle Identification Number.....                           | 336 | Technical Specifications.....       | 330 |
| <b>Voice Control.....</b>   | 73  | <b>Windows and Mirrors.....</b>     | 86  |
| <b>W</b>  |     | <b>Windshield Washers.....</b>      | 77  |
| <b>Warning Lamps and Indicators.....</b>                          | 94  | Front Camera Washer.....            | 77  |
| Adaptive Cruise Control.....                                      | 94  | <b>Windshield Wipers.....</b>       | 76  |
| Anti-Lock Braking System.....                                     | 95  | Speed Dependent Wipers.....         | 76  |
| Automatic High Beam Control.....                                  | 95  | <b>Wiper Blades</b>                 |     |
| Battery.....  | 95  | See: Checking the Wiper Blades..... | 288 |
| Blind Spot Monitor.....   | 95  | <b>Wipers and Washers.....</b>      | 76  |
| Brake System.....   | 95  | <b>Wrecker Towing</b>               |     |
|   |     | See: Transporting the Vehicle.....  | 244 |