

## Table of Contents

<b>Introduction</b>	<b>4</b>
<b>Instrument Cluster</b>	<b>12</b>
Warning lights and chimes	12
Gauges	18
Message center	20
<b>Entertainment Systems</b>	<b>39</b>
AM/FM stereo with CD	39
Auxiliary input jack (Line in)	46
USB port	48
Rear seat controls	49
Satellite radio information	56
Navigation system	59
SYNC®	59
<b>Climate Controls</b>	<b>60</b>
Manual heating and air conditioning	60
Dual automatic temperature control	64
Rear window defroster	70
<b>Lights</b>	<b>71</b>
Headlamps	71
Turn signal control	74
Bulb replacement	76
<b>Driver Controls</b>	<b>82</b>
Windshield wiper/washer control	82
Steering wheel adjustment	84
Power windows	89
Mirrors	91
Speed control	96
Moon roof	100

## Table of Contents

### **Locks and Security 114**

Keys	114
Locks	120
Anti-theft system	132

### **Seating and Safety Restraints 138**

Seating	138
Safety restraints	159
Airbags	173
Child restraints	183

### **Tires, Wheels and Loading 202**

Tire information	204
Tire inflation	207
Tire Pressure Monitoring System (TPMS)	219
Vehicle loading	223
Trailer towing	231
Recreational towing	236

### **Driving 237**

Starting	237
Brakes	243
AdvanceTrac®	246
Air suspension	252
Transmission operation	256
Reverse sensing system	260
Rear-view camera system	262

### **Roadside Emergencies 275**

Getting roadside assistance	275
Hazard flasher control	276
Fuel pump shut-off switch	277
Fuses and relays	278
Changing tires	286
Wheel lug nut torque	295
Jump starting	296
Wrecker towing	300

## Table of Contents

<b>Customer Assistance</b>	<b>302</b>
Reporting safety defects (U.S. only)	309
Reporting safety defects (Canada only)	309
<b>Cleaning</b>	<b>310</b>
<b>Maintenance and Specifications</b>	<b>318</b>
Engine compartment	320
Engine oil	323
Battery	326
Engine coolant	328
Fuel information	334
Air filter(s)	348
Part numbers	353
Maintenance product specifications and capacities	354
Engine data	358
<b>Accessories</b>	<b>362</b>
<b>Ford Extended Service Plan</b>	<b>364</b>
<b>Scheduled Maintenance Guide</b>	<b>368</b>
Normal scheduled maintenance and log	373
<b>Index</b>	<b>389</b>

All rights reserved. Reproduction by any means, electronic or mechanical including photocopying, recording or by any information storage and retrieval system or translation in whole or part is not permitted without written authorization from Ford Motor Company. Ford may change the contents without notice and without incurring obligation.

Copyright © 2010 Ford Motor Company

<https://www.MyCarManual.com>

3

## Introduction

### CONGRATULATIONS

Congratulations on acquiring your new Ford. Please take the time to get well acquainted with your vehicle by reading this handbook. The more you know and understand about your vehicle, the greater the safety and pleasure you will derive from driving it.

For more information on Ford Motor Company and its products visit the following website:

- In the United States: [www.ford.com](http://www.ford.com)
- In Canada: [www.ford.ca](http://www.ford.ca)
- In Australia: [www.ford.com.au](http://www.ford.com.au)
- In Mexico: [www.ford.com.mx](http://www.ford.com.mx)

Additional owner information is given in separate publications.

This Owner's Guide describes every option and model variant available and therefore some of the items covered may not apply to your particular vehicle. Furthermore, due to printing cycles it may describe options before they are generally available.

Remember to pass on this Owner's Guide when reselling the vehicle. It is an integral part of the vehicle.



**WARNING: Fuel pump shut-off switch:** In the event of an accident the safety switch will automatically cut off the fuel supply to the engine. The switch can also be activated through sudden vibration (e.g. collision when parking). To reset the switch, refer to the *Fuel pump shut-off switch* in the *Roadside Emergencies* chapter.

### SAFETY AND ENVIRONMENT PROTECTION



#### Warning symbols in this guide

How can you reduce the risk of personal injury to yourself or others? In this guide, answers to such questions are contained in comments highlighted by the warning triangle symbol. These comments should be read and observed.

## Introduction

### **Warning symbols on your vehicle**

When you see this symbol, it is imperative that you consult the relevant section of this guide before touching or attempting adjustment of any kind.



### **Protecting the environment**

We must all play our part in protecting the environment. Correct vehicle usage and the authorized disposal of waste, cleaning and lubrication materials are significant steps towards this aim. Information in this respect is highlighted in this guide with the tree symbol.



### **CALIFORNIA Proposition 65 Warning**



**WARNING:** Engine exhaust, some of its constituents, and certain vehicle components contain or emit chemicals known to the State of California to cause cancer and birth defects or other reproductive harm. In addition, certain fluids contained in vehicles and certain products of component wear contain or emit chemicals known to the State of California to cause cancer and birth defects or other reproductive harm.

### **PERCHLORATE MATERIAL**

Certain components of this vehicle such as airbag modules, seat belt pretensioners, and button cell batteries may contain Perchlorate Material – Special handling may apply for service or vehicle end of life disposal. See [www.dtsc.ca.gov/hazardouswaste/perchlorate](http://www.dtsc.ca.gov/hazardouswaste/perchlorate).

### **BREAKING-IN YOUR VEHICLE**

Your vehicle does not need an extensive break-in. Try not to drive continuously at the same speed for the first 1,000 miles (1,600 km) of new vehicle operation. Vary your speed frequently in order to give the moving parts a chance to break in.

Drive your new vehicle at least 1,000 miles (1,600 km) before towing a trailer. For more detailed information about towing a trailer, refer to *Trailer towing* in the *Tires, Wheels and Loading* chapter.

<https://www.MyCarManual.com>

## Introduction

Do not add friction modifier compounds or special break-in oils since these additives may prevent piston ring seating. See *Engine oil* in the *Maintenance and Specifications* chapter for more information on oil usage.

### SPECIAL NOTICES

#### New Vehicle Limited Warranty

For a detailed description of what is covered and what is not covered by your vehicle's New Vehicle Limited Warranty, refer to the *Warranty Guide* that is provided to you along with your Owner's Guide.

#### Special instructions

For your added safety, your vehicle is fitted with sophisticated electronic controls.



**WARNING:** Please read the section *Airbag Supplemental Restraint System (SRS)* in the *Seating and Safety Restraints* chapter. Failure to follow the specific warnings and instructions could result in personal injury.



**WARNING:** Front seat mounted rear-facing child or infant seats should **NEVER** be placed in front of an active passenger airbag.

#### Notice to owners of pickup trucks and utility type vehicles



**WARNING:** Utility vehicles have a significantly higher rollover rate than other types of vehicles.

Before you drive your vehicle, please read this Owner's Guide carefully. Your vehicle is not a passenger car. As with other vehicles of this type, failure to operate this vehicle correctly may result in loss of vehicle control, vehicle rollover, personal injury or death.

#### Using your vehicle with a snowplow

##### **Do not use this vehicle for snowplowing.**

Your vehicle is not equipped with a snowplowing package.

### DATA RECORDING

#### Service Data Recording

Service data recorders in your vehicle are capable of collecting and storing diagnostic information about your vehicle. This potentially includes information about the performance or status of various systems and modules in the vehicle, such as engine, throttle, steering or brake systems. In order to properly diagnose and service your vehicle, Ford Motor Company, Ford of Canada, and service and repair facilities may access or share among them vehicle diagnostic information received through a direct connection to your vehicle when diagnosing or servicing your vehicle. For U.S. only (if equipped), if you choose to use the SYNC® Vehicle Health Report, you consent that certain diagnostic information may also be accessed electronically by Ford Motor Company and Ford authorized service facilities, and that the diagnostic information may be used for any purpose. See your SYNC® supplement for more information.

#### Event Data Recording

**This vehicle is equipped with an event data recorder (EDR). The main purpose of an EDR is to record, in certain crash or near crash-like situations, such as an airbag deployment or hitting a road obstacle; this data will assist in understanding how a vehicle's systems performed. The EDR is designed to record data related to vehicle dynamics and safety systems for a short period of time, typically 30 seconds or less. The EDR in this vehicle is designed to record such data as:**

- **How various systems in your vehicle were operating;**
- **Whether or not the driver and passenger seatbelts were buckled/fastened;**
- **How far (if at all) the driver was depressing the accelerator and/or the brake pedal; and**
- **How fast the vehicle was travelling; and**
- **Where the driver was positioning the steering wheel.**

**This data can help provide a better understanding of the circumstances in which crashes and injuries occur.**

**Note: EDR data is recorded by your vehicle only if a non-trivial crash situation occurs; no data is recorded by the EDR under normal driving conditions and no personal data or information (e.g., name, gender, age, and crash location) is recorded (see**

<https://www.MyCarManual.com>

## Introduction

limitations regarding 911 Assist and Traffic, directions and Information privacy below). However, parties, such as law enforcement, could combine the EDR data with the type of personally identifying data routinely acquired during a crash investigation.

To read data recorded by an EDR, special equipment is required, and access to the vehicle or the EDR is needed. In addition to the vehicle manufacturer, other parties, such as law enforcement, that have such special equipment, can read the information if they have access to the vehicle or the EDR. Ford Motor Company and Ford of Canada do not access event data recorder information without obtaining consent, unless pursuant to court order or where required by law enforcement, other government authorities or other third parties acting with lawful authority. Other parties may seek to access the information independently of Ford Motor Company and Ford of Canada.

**Note:** Including to the extent that any law pertaining to Event Data Recorders applies to SYNC® or its features, please note the following: Once 911 Assist (if equipped) is enabled (set ON), 911 Assist may, through any paired and connected cell phone, disclose to emergency services that the vehicle has been in a crash involving the deployment of an airbag or, in certain vehicles, the activation of the fuel pump shut-off. Certain versions or updates to 911 Assist may also be capable of being used to electronically or verbally provide to 911 operators the vehicle location (such as latitude and longitude), and/or other details about the vehicle or crash or personal information about the occupants to assist 911 operators to provide the most appropriate emergency services. If you do not want to disclose this information, do not activate the 911 Assist feature. See your SYNC® supplement for more information.

Additionally, when you connect to Traffic, Directions and Information (if equipped, U.S. only) the service uses GPS technology and advanced vehicle sensors to collect the vehicle's current location, travel direction, and speed ("vehicle travel information") only to help provide you with the directions, traffic reports, or business searches your request. If you do not want Ford or its vendors to receive this information, do not activate the service. Ford Motor Company and the vendors it uses to provide you with this information do not store your vehicle travel information. For more information, see Traffic, Directions and Information, Terms and Conditions. See your SYNC® supplement for more information.



## Introduction

### CELL PHONE USE

The use of Mobile Communications Equipment has become increasingly important in the conduct of business and personal affairs. However, drivers must not compromise their own or others' safety when using such equipment. Mobile Communications can enhance personal safety and security when appropriately used, particularly in emergency situations. Safety must be paramount when using mobile communications equipment to avoid negating these benefits.

Mobile Communication Equipment includes, but is not limited to, cellular phones, pagers, portable email devices, text messaging devices and portable two-way radios.



**WARNING:** Driving while distracted can result in loss of vehicle control, accident and injury. Ford strongly recommends that you use extreme caution when using any device or feature that may take your focus off the road. Your primary responsibility is the safe operation of your vehicle.

We recommend against the use of any handheld device while driving and that you comply with all applicable laws.









### EXPORT UNIQUE (NON-UNITED STATES/CANADA) VEHICLE SPECIFIC INFORMATION

For your particular global region, your vehicle may be equipped with features and options that are different from the features and options that are described in this Owner's Guide. A market unique supplement may be supplied that complements this book. By referring to the market unique supplement, if provided, you can properly identify those features, recommendations and specifications that are unique to your vehicle. This Owner's Guide is written primarily for the U.S. and Canadian Markets. Features or equipment listed as standard may be different on units built for Export. **Refer to this Owner's Guide for all other required information and warnings.**











## Introduction

These are some of the symbols you may see on your vehicle.

### Vehicle Symbol Glossary

Safety Alert		See Owner's Guide	
Fasten Safety Belt		Airbag - Front	
Airbag - Side		Child Seat Lower Anchor	
Child Seat Tether Anchor		Brake System	
Anti-Lock Brake System		Parking Brake System	
Brake Fluid - Non-Petroleum Based		Parking Aid System	
Stability Control System		Speed Control	
Master Lighting Switch		Hazard Warning Flasher	
Fog Lamps-Front		Fuse Compartment	
Fuel Pump Reset		Windshield Wash/Wipe	
Windshield Defrost/Demist		Rear Window Defrost/Demist	

## Vehicle Symbol Glossary

Power Windows Front/Rear		Power Window Lockout	
Child Safety Door Lock/Unlock		Interior Luggage Compartment Release	
Panic Alarm		Engine Oil	
Engine Coolant		Engine Coolant Temperature	
Do Not Open When Hot		Battery	
Avoid Smoking, Flames, or Sparks		Battery Acid	
Explosive Gas		Fan Warning	
Power Steering Fluid		Maintain Correct Fluid Level	
Service Engine Soon		Engine Air Filter	
Passenger Compartment Air Filter		Jack	
Check Fuel Cap		Low Tire Pressure Warning	

## Instrument Cluster

### WARNING LIGHTS AND CHIMES

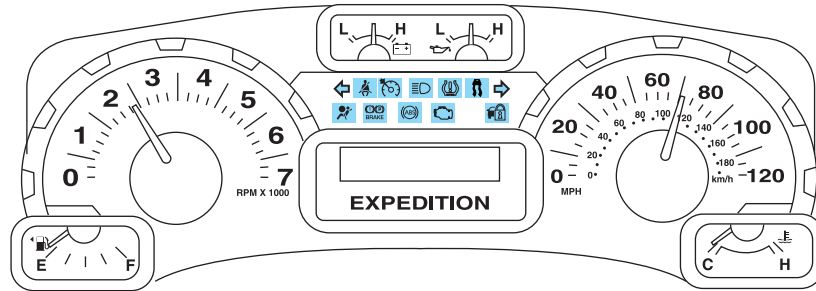

Warning lights and gauges can alert you to a vehicle condition that may become serious enough to cause expensive repairs. A warning light may illuminate when a problem exists with one of your vehicle's functions. Many lights will illuminate when you start your vehicle to make sure the bulb works. If any light remains on after starting the vehicle, refer to the respective system warning light for additional information.

**Note:** Some warning lights are reconfigurable telltale (RTT) indicator lights and will illuminate in the message center. These lights function the same as the other warning lights.

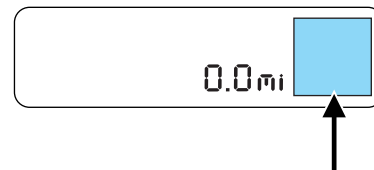

**Service engine soon:** The service engine soon indicator light illuminates when the ignition is first turned to the on position to check the bulb and to indicate whether the vehicle is ready for Inspection/Maintenance (I/M) testing. Normally, the service engine soon light will stay on until the engine is cranked, then turn itself off if no malfunctions are present. However, if after 15 seconds the service engine soon light blinks eight times, it means that the vehicle is not ready for I/M testing. See the *Readiness for Inspection/Maintenance (I/M) testing* in the *Maintenance and Specifications* chapter.

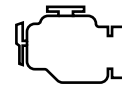

## Instrument Cluster

Solid illumination after the engine is started indicates the on-board diagnostics system (OBD-II) has detected a malfunction. Refer to *On-board diagnostics (OBD-II)* in the *Maintenance and Specifications* chapter. If the light is blinking, engine misfire is occurring which could damage your catalytic converter. Drive in a moderate fashion (avoid heavy acceleration and deceleration) and have your vehicle serviced immediately by your authorized dealer.



**WARNING:** Under engine misfire conditions, excessive exhaust temperatures could damage the catalytic converter, the fuel system, interior floor coverings or other vehicle components, possibly causing a fire.

### **Powertrain malfunction/reduced power (RTT) (if equipped):**

Displays when the vehicle has defaulted to a “limp-home” operation. Report the fault to a dealer at the earliest opportunity.



### **Check 4X4 (RTT) (if equipped):**

Displays with the message CHECK 4X4 when a four-wheel drive fault is present.



When this warning appears have your vehicle serviced by your authorized dealer.

Refer to the *Driving* chapter for more information on four-wheel drive operation.

**Brake system warning light:** To confirm the brake system warning light is functional, it will momentarily illuminate when the ignition is turned to the on position

when the engine is not running, or in a position between on and start, or by applying the parking brake when the ignition is turned to the on position. If the brake system warning light does not illuminate at this time, seek service immediately from your authorized dealer. Illumination after releasing the parking brake indicates low brake fluid level and the brake system should be inspected immediately by your authorized dealer.

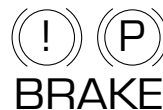

## Instrument Cluster

 **WARNING:** Driving a vehicle with the brake system warning light on is dangerous. A significant decrease in braking performance may occur. It will take you longer to stop the vehicle. Have the vehicle checked by your authorized dealer. Driving extended distances with the parking brake engaged can cause brake failure and the risk of personal injury.

**Anti-lock brake system:** If the ABS light stays illuminated or continues to flash, a malfunction has been detected, have the system serviced immediately by your authorized dealer. Normal braking is still functional unless the brake warning light also is illuminated.

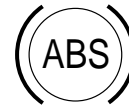

**Airbag readiness:** If this light fails to illuminate when the ignition is turned to on, continues to flash or remains on, have the system serviced immediately by your authorized dealer. A chime will sound when there is a malfunction in the indicator light.



**Safety belt:** Reminds you to fasten your safety belt. A Belt-Minder® chime will also sound to remind you to fasten your safety belt. Refer to the *Seating and Safety Restraints* chapter to activate/deactivate the Belt-Minder® chime feature.



**Charging system (RTT):** Illuminates when the battery is not charging properly. If it stays on while the engine is running, there may be a malfunction with the charging system. Contact your authorized dealer as soon as possible. This indicates a problem with the electrical system or a related component.



**Security/anti-theft system:** Flashes when the SecuriLock® passive anti-theft system has been activated.



## Instrument Cluster

### **Engine oil pressure (RTT):**

Displays when the oil pressure falls below the normal range. Refer to *Engine oil* in the *Maintenance and Specifications* chapter.

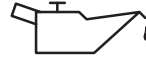

### **Engine coolant temperature (RTT):**

Displays when the engine coolant temperature is high. Stop the vehicle as soon as safely possible, switch off the engine and let it cool. Refer to *Engine coolant* in the *Maintenance and Specifications* chapter.



**WARNING:** Never remove the coolant reservoir cap while the engine is running or hot.

**Low tire pressure warning (if equipped):** Illuminates when your tire pressure is low. If the light remains on at start up or while driving, the tire pressure should be checked. Refer to *Inflating your tires* in the *Tires, Wheels and Loading* chapter. When the ignition is first turned to on, the light will illuminate for three seconds to ensure the bulb is working. If the light does not turn on or begins to flash, have the system inspected by your authorized dealer. For more information on this system, refer to *Tire pressure monitoring system (TPMS)* in the *Tires, Wheels and Loading* chapter.

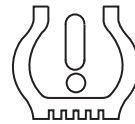

### **Low fuel (RTT) (if equipped):**

Displays when the fuel level in the fuel tank is at or near empty (refer to *Fuel gauge* in this chapter).



**Low washer fluid (RTT) (if equipped):** Displays when the windshield washer fluid is low.



## Instrument Cluster

### **Transmission Tow/Haul Feature**

**(RTT):** Displays when the Tow/Haul feature has been activated. Refer to the *Driving* chapter for

transmission function and operation. If the light flashes steadily, have the system serviced immediately, damage to the transmission could occur.

**TOW  
HAUL**

### **AdvanceTrac® (if equipped):**

Displays when the AdvanceTrac® with RSC® system is active. If the light remains on, have the system serviced immediately, refer to the *Driving* chapter for more information.



**Speed control:** Illuminates when the speed control is activated. Turns off when the speed control system is deactivated.

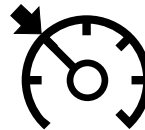

### **4X2 (RTT) (if equipped):**

Displays momentarily when two-wheel drive high is selected. If the light fails to display when the ignition is turned on, or remains on, have the system serviced immediately by your authorized dealer.

**4x2**

### **Four-wheel drive low (RTT) (if equipped):**

Displays when four-wheel drive low is engaged. If the light fails to display when the ignition is turned on, or remains on, have the system serviced immediately by your authorized dealer.

**4x4  
LOW**

### **Four-wheel drive (RTT) (if equipped):**

Displays when four-wheel drive is engaged. If the light fails to display when the ignition is turned on, or remains on, have the system serviced immediately by your authorized dealer.

**4x4**



## Instrument Cluster

**Four-wheel drive auto (RTT) (if equipped):** Displays when four-wheel drive automatic mode is engaged. If the light fails to display when the ignition is turned on, or remains on, have the system serviced immediately by your authorized dealer.

**4x4  
AUTO**

**Door ajar (RTT) (if equipped):** Displays when the ignition is in the on position and any door, liftgate or the liftgate glass is open.



**Turn signal:** Illuminates when the left or right turn signal or the hazard lights are turned on. If the indicators stay on or flash faster, check for a burned out bulb.



**High beams:** Illuminates when the high beam headlamps are turned on.



**Key-in-ignition warning chime (if equipped):** Sounds when the key is left in the ignition in the off or accessory position and the driver's door is opened.

**Headlamps on warning chime:** Sounds when the headlamps or parking lamps are on, the ignition is off (the key is not in the ignition) and the driver's door is opened.

**Parking brake on warning chime:** Sounds when the parking brake is set, the engine is running and the vehicle is driven more than 3 mph (5 km/h).

**Turn signal chime:** Sounds when the turn signal lever has been activated to signal a turn and not turned off after the vehicle is driven more than 1.5 miles (2.4 km).

**Message center activation chime:** Sounds when some warning messages appear in the message center display for the first time.

**Reverse warning chime (if equipped):** Sounds when the vehicle is in R (Reverse). Refer to the *Driving* chapter for more information.

## Instrument Cluster

### GAUGES

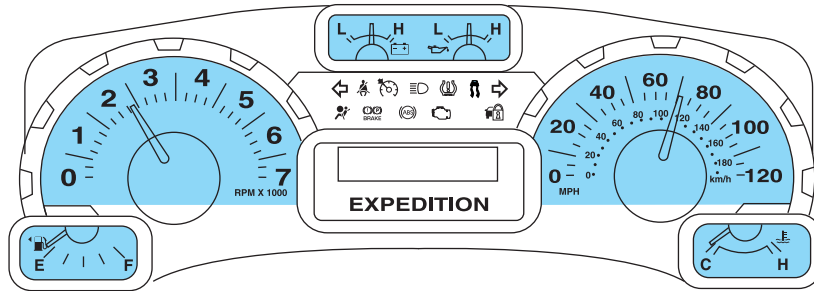

**Speedometer:** Indicates the current vehicle speed.

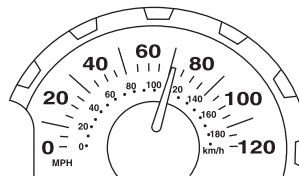

**Engine coolant temperature gauge:** Indicates engine coolant temperature. At normal operating temperature, the needle will be in the normal range (between “H” and “C”). If it enters the red section, the engine is overheating. Stop the vehicle as soon as safely possible, switch off the engine and let the engine cool.

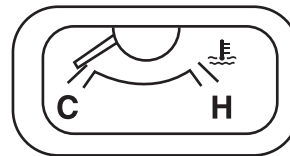

**WARNING:** Never remove the coolant reservoir cap while the engine is running or hot.

## Instrument Cluster

**Odometer:** Registers the total miles (kilometers) of the vehicle.

- With standard message center



- With optional message center

Refer to *Message center* in this chapter for information on how to switch the display from Metric to English.

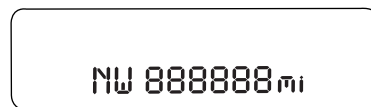

**Trip odometer:** Registers the miles (kilometers) of individual journeys.

- With standard message center

Press the SELECT/RESET stem once to switch from the odometer to the trip odometer. Press the stem again to select trip A and trip B features. To reset the trip, press and hold the stem until it resets.

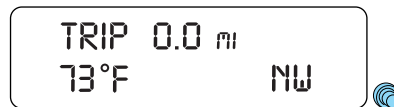

- With optional message center: see *TRIP A/B* under *Message center* in this chapter.

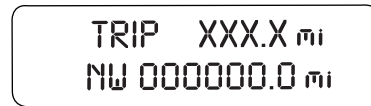

**Tachometer:** Indicates the engine speed in revolutions per minute. Driving with your tachometer pointer continuously at the top of the scale may damage the engine.

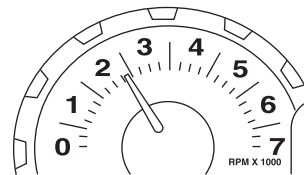

**Battery voltage gauge:** Indicates the battery voltage when the ignition is in the on position. If the pointer moves and stays outside the normal operating range, have the vehicle's electrical system checked by your authorized dealer as soon as possible.

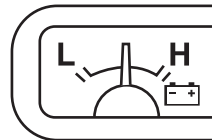

## Instrument Cluster

### Engine oil pressure gauge:

Indicates engine oil pressure. The needle should stay in the normal operating range (between “L” and “H”). If the needle falls below the normal range, stop the vehicle, turn off the engine and check the engine oil level. Add oil if needed. If the oil level is correct, have your vehicle checked by your authorized dealer.

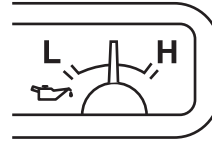

**Fuel gauge:** Indicates approximately how much fuel is left in the fuel tank (when the ignition is in the on position). The fuel gauge may vary slightly when the vehicle is in motion or on a grade.

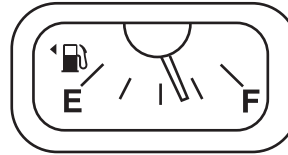

Refer to *Filling the tank* in the *Maintenance and Specifications* chapter for more information.

The fuel icon and arrow indicates which side of the vehicle the fuel door is located.

### STANDARD MESSAGE CENTER (IF EQUIPPED)

Your vehicle's message center is capable of monitoring many vehicle systems and will alert you to potential vehicle problems and various conditions with an informational message followed by a long indicator chime.

The message center display is located in the instrument cluster.

### Selectable features (information menu)

Press and release the SELECT/RESET stem to scroll and reset the following functions. Reset the function by a single press of the SELECT/RESET stem for more than two seconds.

#### TRIP

Registers the distance of individual journeys. Press and release the SELECT/RESET stem on the cluster to toggle between odometer and trip odometer display. To reset, press and hold for less than two seconds.

#### MYKEY MILES (km) (if programmed)

For more information, refer to *MyKey™* in the *Locks and Security* chapter.

## Instrument Cluster

### **MILES (km) TO E**

This displays an estimate of approximately how far you can drive with the fuel remaining in your tank under normal driving conditions. Remember to turn the ignition off when refueling to allow this feature to correctly detect the added fuel.

LOW FUEL LEVEL will display when you have approximately 50 miles (80 km), to empty. Press RESET to clear this warning message. It will return at approximately 25 miles (40 km), 10 miles (16 km) and 0 miles (0 km) miles to empty.

Distance to empty is calculated using a running average fuel economy, which is based on your recent driving history of 500 miles (800 km). This value is not the same as the average fuel economy display. The running average fuel economy is re-initialized to a factory default value if the battery is disconnected.

### **AVG MPG (L/100km)**

Average fuel economy displays your average fuel economy in miles/gallon or liters/100 km.

If you calculate your average fuel economy by dividing distance traveled by gallons of fuel used (liters of fuel used by 100 kilometers traveled), your figure may be different than displayed for the following reasons:

- Your vehicle was not perfectly level during fill-up
- Differences in the automatic shut-off points on the fuel pumps at service stations
- Variations in top-off procedure from one fill-up to another
- Rounding of the displayed values to the nearest 0.1 gallon (liter)

To determine your average highway fuel economy, do the following:

1. Drive the vehicle at least 5 miles (8 km) with the speed control system engaged to display a stabilized average.
2. Record the highway fuel economy for future reference.

It is important to press the SELECT/RESET stem (press and hold for two seconds in order to reset the function) after setting the speed control to get accurate highway fuel economy readings.

### **XX°F / XX°C**

The outside air temperature is shown together with the compass heading in the bottom row of the message center display. Refer to *Units* in this section for information on selecting °F or °C.

## Instrument Cluster

### COMPASS DISPLAY (if equipped)

The compass heading is displayed as one of N, NE, E, SE, S, SW, W and NW in the message center display.

The compass reading may be affected when you drive near large buildings, bridges, power lines and powerful broadcast antenna. Magnetic or metallic objects placed in, on or near the vehicle may also affect compass accuracy.

Usually, when something affects the compass readings, the compass will correct itself after a few days of operating your vehicle in normal conditions. If the compass still appears to be inaccurate, a manual calibration may be necessary. Refer to *Compass calibration adjustment*.

Most geographic areas (zones) have a magnetic north compass point that varies slightly from the northerly direction on maps. This variation is up to four degrees between adjacent zones and will become noticeable as the vehicle crosses multiple zones. A correct zone setting will eliminate this error. Refer to *Compass zone adjustment*.

#### *Compass zone adjustment*

1. Determine which magnetic zone you are in for your geographic location by referring to the zone map.

2. Press and release the SELECT/RESET stem to scroll through the information menu until the message center displays HOLD RESET FOR SETUP MENU.

3. Press and hold the SELECT/RESET stem until the message center displays HOLD RESET FOR SYSTEM CHECK. Do not hold the stem down at this point as you do not want to enter the system check. Instead, quickly release the stem and repeatedly press it again to scroll through the setup menu until the message center displays COMPASS ZONE XX.

4. Press and hold the SELECT/RESET stem for approximately two seconds to enter the compass zone adjustment mode.

5. Press and hold the SELECT/RESET stem until the next zone number appears. Repeat to select zone.

6. Release the SELECT/RESET stem and allow the setup timer to expire to exit the procedure.

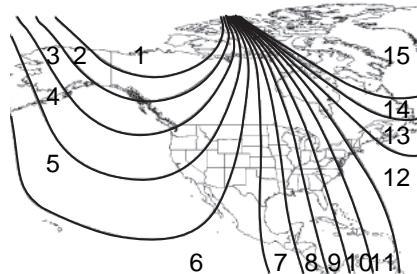

## Instrument Cluster

### *Compass calibration adjustment*

**NOTE:** For optimum calibration, drive to an open, level location away from large metallic objects or structures. Switch off all non-essential electrical accessories (heated rear window, heater, A/C, map lamps, wiper, etc.) and make sure all the doors are closed.

1. Start the vehicle.
2. Press and release the SELECT/RESET stem to scroll through the information menu until the message center displays HOLD RESET FOR SETUP MENU.
3. Press and hold the SELECT/RESET stem for approximately two seconds until the message center displays HOLD RESET FOR SYSTEM CHECK. Do not hold the stem down at this point as you do not want to enter the system check. Instead, quickly release the stem and repeatedly press it again to scroll through the setup menu until the message center displays COMPASS ZONE XX.
4. Press and hold the SELECT/RESET stem for approximately two seconds until the message center enters the compass zone adjustment mode.
5. Press and hold the SELECT/RESET stem until the message center displays CIRCLE SLOWLY TO CALIBRATE. This step may require up to five circles to complete the calibration.

**Note:** If the SELECT/RESET stem is pressed during the calibration or three minutes has elapsed since the beginning of the calibration without driving the vehicle, the message center reverts back to normal operation and the CAL will display until a successful calibration is carried out.

6. Slowly drive the vehicle in a circle less than 3 mph (5 km/h ) until the CIRCLE SLOWLY TO CALIBRATE message changes to CALIBRATION COMPLETED.

### **Setup menu (vehicle customization and vehicle system check)**

#### **HOLD RESET FOR SETUP MENU**

Press and hold the SELECT/RESET stem to get into the setup menu sequence for the following displays:

**Note:** When returning to the SETUP menu and a non-English language has been selected, HOLD RESET FOR ENGLISH will be displayed to change back to English. Press and hold the SELECT/RESET stem to change back to English.

## Instrument Cluster

### **HOLD RESET FOR SYSTEM CHECK**

Press and hold the SELECT/RESET stem to start the system check when HOLD RESET FOR SYSTEM CHECK is displayed in the message center. For each of the monitored systems, the message center will indicate either an ok message or a warning message for two seconds. Pressing the SELECT/RESET stem cycles the message center through each of the systems being monitored.

**Note:** Some systems show a message only if a condition is present.

1. OIL LIFE
2. CHARGING SYSTEM
3. WASHER FLUID LEVEL
4. DOOR/LIFTGATE/GLASS AJAR
5. BRAKE SYSTEM
6. TIRE PRESSURE
7. FUEL LEVEL (will only display if 50 miles or less to empty)
8. MYKEY DISTANCE (if programmed)
9. MYKEY(S) PROGRAMMED
10. ADMIN KEYS PROGRAMMED

### **OIL LIFE**

This displays the remaining oil life.

An oil change is required whenever indicated by the message center and according to the recommended maintenance schedule. **USE ONLY RECOMMENDED ENGINE OILS.**

To reset the oil monitoring system to 100% after each oil change perform the following:

1. Press and release SETUP to display “OIL LIFE XXX% HOLD RESET = NEW”.
2. Press and hold RESET for two seconds and release to reset the oil life to 100%.

**Note:** To change oil life 100% value to another value, proceed to Step 3.

3. Once “OIL LIFE SET TO XXX%” is displayed, release and press RESET to change the Oil Life Start Value. Each release and press will reduce the value by 10%.

### **UNITS ENG / METRIC**

Displays the current units English or Metric.



## Instrument Cluster

Press and hold the SELECT/RESET stem to change from English to Metric.  
Press the SELECT/RESET stem for the next SETUP MENU item or wait for more than four seconds to return to the INFO MENU.

### **AUTOLAMP**

This feature keeps your headlights on for up to three minutes after the ignition is switched off.

Press the RESET control to select the new Autolamp delay values of 0, 10, 20, 30, 60, 90, 120 or 180 seconds.

### **AUTOLOCK**

This feature automatically locks all vehicle doors when the vehicle is shifted into any gear, putting the vehicle in motion.

Press the RESET control to turn autolock on or off.

### **AUTOUNLOCK**

This feature automatically unlocks all vehicle doors when the driver's door is opened within 10 minutes of the ignition being turned off.

Press the RESET control to turn autounlock on or off.

### **TRAILER SWAY (if equipped)**

This feature uses the electronic stability control to mitigate trailer sway,

Press the RESET control to turn trailer sway on or off.

### **CREATE MYKEY / MYKEY SETUP / CLEAR MYKEY**

For more information refer to *MyKey™* in the *Locks and Security* chapter.

### **LANGUAGE = ENGLISH / SPANISH / FRENCH**

Allows you to choose which language the message center will display in. Selectable languages are English, Spanish, or French.

**Note:** When entering the SETUP MENU and a non-English language has been selected, "PRESS RESET FOR ENGLISH" will be displayed to change back to English.

Press and hold the SELECT/RESET stem to select a new language. Selectable languages are English, Spanish and French

Press and hold the RESET button for two seconds to set the language choice.

Press the SELECT/RESET stem for the next SETUP MENU item or wait for more than four seconds to return to the INFO MENU.

## Instrument Cluster

### **System warnings**

System warnings alert you to possible problems or malfunctions in your vehicle's operating systems.

In the event of a multiple warning situation, the message center will cycle the display to show all warnings by displaying each one for four seconds.

The message center will display the last selected feature if there are no more warning messages.

Types of messages and warnings:

- Some messages will appear briefly to inform you of something you may need to take action on or be informed of.
- Some messages will appear once and then again when the vehicle is restarted.
- Some messages will reappear after clearing or being reset if a problem or condition is still present and needs your attention.
- Some messages can be acknowledged and reset by pressing the SELECT/RESET stem. This allows you to use the full message center functionality by clearing the message.

**DOOR AJAR** — Displayed when a door is not completely closed.

**LIFTGATE / GLASS AJAR** — Displayed when the liftgate or the liftgate glass is not completely closed.

**CHECK CHARGING SYSTEM** — Displayed when the electrical system is not maintaining proper voltage when the engine is running. If you are operating electrical accessories when the engine is idling at a low speed, turn off as many of the electrical loads as soon as possible. If the warning stays on or comes on when the engine is operating at normal speeds, have the electrical system checked as soon as possible.

**PARK BRAKE ENGAGED** — Displayed when the parking brake is set, the engine is running and the vehicle is driven more than 3 mph (5 km/h). If the warning stays on after the parking brake is released, contact your authorized dealer as soon as possible.

**CHECK BRAKE SYSTEM** — Displayed when the braking system is not operating properly. If the warning stays on or continues to come on, contact your authorized dealer as soon as possible.

**CHECK FUEL FILL INLET** — Displayed when the fuel fill inlet may not be properly closed. Refer to *Easy Fuel™ “no cap” fuel system* in the *Maintenance and Specifications* chapter.

## Instrument Cluster

**LOW TIRE PRESSURE** — Displayed when one or more tires on your vehicle have low tire pressure. Refer to *Inflating your tires* in the *Tires, Wheels and Loading* chapter.

**TIRE PRESSURE MONITOR FAULT** — Displayed when the Tire Pressure Monitoring System is malfunctioning. If the warning stays on or continues to come on, contact your authorized dealer as soon as possible.

**TIRE PRESSURE SENSOR FAULT** — Displayed when a tire pressure sensor is malfunctioning, or your spare tire is in use. For more information on how the system operates under these conditions, refer to *Understanding your Tire Pressure Monitoring System (TPMS)* in the *Tires, Wheels and Loading* chapter. If the warning stays on or continues to come on, contact your authorized dealer as soon as possible.

**4X4 SHIFT IN PROGRESS (if equipped)** — Displayed when the 4X4 system is making a shift. For further information, refer to *Control Trac® four-wheel drive (4x4) operation* in the *Driving* chapter.

**FOR 4X4 LOW SLOW TO 3 MPH (if equipped)** — Displayed when 4X4 LOW is selected while the vehicle is moving. For more information, refer to *Control Trac® four-wheel drive (4X4) operation* in the *Driving* chapter.

**FOR 4X4 LOW SHIFT TO N (if equipped)** — Displayed when 4X4 LOW is selected and the vehicle is stopped. For more information, refer to *Control Trac® four-wheel drive (4X4) operation* in the *Driving* chapter.

**TO EXIT 4X4 LOW SLOW TO 3 MPH (if equipped)** — Displayed when 2WD is selected while the vehicle is operating in 4X4 LOW. For more information, refer to *Control Trac® four-wheel drive (4X4) operation* in the *Driving* chapter.

**TO EXIT 4X4 LOW SHIFT TO N (if equipped)** — Displayed when 2WD is selected while the vehicle has been stopped in 4X4 LOW. For more information, refer to *Control Trac® four-wheel drive (4X4) operation* in the *Driving* chapter.

**SHIFT DELAYED PULL FORWARD (if equipped)** — May display when shifting to or from 4X4 LOW. For more information, refer to *Control Trac® four-wheel drive (4X4) operation* in the *Driving* chapter.

**TRAILER SWAY REDUCE SPEED (if equipped)** — Displayed when the trailer sway control has detected trailer sway. For more information, refer to the *Driving* chapter for more information.

## Instrument Cluster

**BRAKE FLUID LEVEL LOW** — Indicates the brake fluid level is low and the brake system should be inspected immediately. Refer to *Brake fluid* in the *Maintenance and Specifications* chapter.

**XXX MILES TO E FUEL LEVEL LOW** — Displayed as an early reminder of a low fuel condition.

**WASHER FLUID LEVEL LOW** — Indicates the washer fluid reservoir is less than one quarter full. Check the washer fluid level. Refer to *Windshield washer fluid* in the *Maintenance and Specifications* chapter.

**ENGINE OIL CHANGE SOON** — Displayed when the engine oil life remaining is 10% or less.

**OIL CHANGE REQUIRED** — Displayed when the oil life left reaches 0%.

**MYKEY ACTIVE DRIVE SAFELY** — Displayed at startup when MyKey™ is in use. Refer to *MyKey™* in the *Locks and Security* chapter for more information.

**KEY COULD NOT PROGRAM** — Displayed when an attempt is made to program a spare key using two existing MyKeys. Refer to *MyKey™* in the *Locks and Security* chapter for more information.

**VEHICLE SPEED 80 MPH MAX** — Displayed when a MyKey™ is in use and the Admin has enabled the MyKey speed limit and the vehicle speed is 80 mph (130 km/h). Refer to *MyKey™* in the *Locks and Security* chapter for more information.

**SPEED LIMITED TO 80 MPH** — Displayed when starting the vehicle and MyKey™ is in use and the MyKey speed limit is on. Refer to *MyKey™* in the *Locks and Security* chapter for more information.

**CHECK SPEED DRIVE SAFELY** — Displayed when a MyKey™ is in use and the optional setting is on and the vehicle exceeds a preselected speed. Refer to *MyKey™* in the *Locks and Security* chapter for more information.

**VEHICLE NEAR TOP SPEED** — Displayed when a MyKey™ is in use and the MyKey speed limit is on and the vehicle speed is approaching 80 mph (130 km/h). Refer to *MyKey™* in the *Locks and Security* chapter for more information.

**TOP SPEED MYKEY SETTING** — Displayed when a MyKey™ is in use and the MyKey speed limit is on and the vehicle speed is 80 mph (130 km/h). Refer to *MyKey™* in the *Locks and Security* chapter for more information.

## Instrument Cluster

**BUCKLE UP TO UNMUTE AUDIO** — Displayed when a MyKey™ is in use and Belt-Minder® is activated. Refer to *MyKey™* in the *Locks and Security* chapter for more information.

**ADVTRAC ON MYKEY SETTING** — Displayed when a MyKey™ is in use when trying to disable the AdvanceTrac® system and the optional setting is on. Refer to *MyKey™* in the *Locks and Security* chapter for more information.

**SERVICE ADVANCETRAC** — Displayed when the AdvanceTrac® system has detected a condition that requires service. Contact your authorized dealer as soon as possible.

### OPTIONAL MESSAGE CENTER (IF EQUIPPED)

Your vehicle's message center is capable of monitoring many vehicle systems and will alert you to potential vehicle problems and various conditions with an informational message followed by a long indicator chime.

The message center display is located in the instrument cluster.

#### Info

Press the INFO button repeatedly to cycle through the following features:



#### TRIP A/B

Registers the distance of individual journeys. Press and release INFO button until the A or B trip appears in the display (this represents the trip mode). Press and hold the RESET button to reset.

Refer to *UNITS* later in this section to switch the display from Metric to English.

#### MYKEY MILES (km) (if programmed)

For more information, refer to *MyKey™* in the *Locks and Security* chapter.

#### MILES (km) TO E

This displays an estimate of approximately how far you can drive with the fuel remaining in your tank under normal driving conditions. Remember to turn the ignition off when refueling to allow this feature to correctly detect the added fuel.

## Instrument Cluster

LOW FUEL LEVEL will display when you have approximately 50 miles (80 km), to empty. Press RESET to clear this warning message. It will return at approximately 25 miles (40 km), 10 miles (16 km) and 0 miles (0 km) miles to empty.

Distance to empty is calculated using a running average fuel economy, which is based on your recent driving history of 500 miles (800 km). This value is not the same as the average fuel economy display. The running average fuel economy is re-initialized to a factory default value if the battery is disconnected.

### **AVG MPG (L/100km)**

Average fuel economy displays your average fuel economy in miles/gallon or liters/100 km.

If you calculate your average fuel economy by dividing distance traveled by gallons of fuel used (liters of fuel used by 100 kilometers traveled), your figure may be different than displayed for the following reasons:

- Your vehicle was not perfectly level during fill-up
- Differences in the automatic shut-off points on the fuel pumps at service stations
- Variations in top-off procedure from one fill-up to another
- Rounding of the displayed values to the nearest 0.1 gallon (liter)

To determine your average highway fuel economy, do the following:

1. Drive the vehicle at least 5 miles (8 km) with the speed control system engaged to display a stabilized average.
2. Record the highway fuel economy for future reference.

It is important to press the RESET button (press and hold RESET for two seconds in order to reset the function) after setting the speed control to get accurate highway fuel economy readings.

For more information refer to *Essentials of good fuel economy* in the *Maintenance and Specifications* chapter.

### **MPG (L/km) ↑ ↓**

This displays instantaneous fuel economy as a bar graph ranging from ↓ poor economy to ↑ excellent economy.

Your vehicle must be moving to calculate instantaneous fuel economy. When your vehicle is not moving, this function shows ↓, one or no bars illuminated. Instantaneous fuel economy cannot be reset.

## Instrument Cluster

### **TIMER**

Timer displays the trip elapsed drive time.

To operate, do the following:

1. Press and release RESET in order to start the timer.
2. Press and release RESET to pause the timer.
3. Press and hold RESET until the timer resets.

### **System check and vehicle feature customization**

Press the SETUP button repeatedly to cycle the message center through the following features:



### **RESET FOR SYSTEM CHECK**

When this message appears, press the RESET button and the message center will begin to cycle through the following systems and provide a status of the item if needed.

**Note:** Some systems show a message only if a condition is present.

1. OIL LIFE
2. CHARGING SYSTEM
3. WASHER FLUID LEVEL
4. DOOR STATUS
5. LIFTGATE/GLASS
6. BRAKE SYSTEM
7. TIRE PRESSURE
8. AIR SUSPENSION SYSTEM (if equipped)
9. FUEL LEVEL
10. MYKEY MILES (if programmed)
11. MYKEY(S) PROGRAMMED
12. ADMIN KEYS PROGRAMMED

### **OIL LIFE**

This displays the remaining oil life.

An oil change is required whenever indicated by the message center and according to the recommended maintenance schedule. USE ONLY RECOMMENDED ENGINE OILS.

## Instrument Cluster

To reset the oil monitoring system to 100% after each oil change perform the following:

1. Press and release SETUP to display “OIL LIFE XXX% HOLD RESET = NEW”.
2. Press and hold RESET for two seconds and release to reset the oil life to 100%.

**Note:** To change oil life 100% value to another value, proceed to Step 3.

3. Once “OIL LIFE SET TO XXX%” is displayed, release and press RESET to change the Oil Life Start Value. Each release and press will reduce the value by 10%.

### UNITS

Displays the current units English or Metric.

Press the RESET button to change from English to Metric.

### AUTOLAMP (SEC)

This feature keeps your headlights on for up to three minutes after the ignition is switched off.

Press the RESET button to select the new Autolamp delay values of 0, 10, 20, 30, 60, 90, 120 or 180 seconds.

### AUTOLOCK

This feature automatically locks all vehicle doors when the vehicle is shifted into any gear, putting the vehicle in motion.

Press the RESET button to turn autolock on or off.

### AUTOUNLOCK

This feature automatically unlocks all vehicle doors when the driver's door is opened within 10 minutes of the ignition being turned off.

Press the RESET button to turn autounlock on or off.

### RUNNING BOARDS (if equipped)

This feature automatically deploys the side running boards for easy entry/exit from the vehicle or for cleaning.

Press the RESET button to select the running boards setting as follows:

- AUTO: the running boards will automatically deploy when a door is opened and automatically retract when the door is closed,
- OUT: the running boards will remain deployed regardless of the doors being open/closed. This setting can be used when washing the vehicle, or accessing the roof rack. The running boards will stow and enter AUTO mode when the vehicle speed exceeds 5 mph (8 km/h),
- OFF: the running boards will remain in regardless of the doors being open/closed.



## Instrument Cluster

### **POWER LIFTGATE (if equipped)**

This feature allows users to open/close the rear liftgate at the touch of a button.

Press the RESET button to turn the power liftgate on or off. If disabled, the outside release handle and the rear cargo area control button are off. The instrument panel button will continue to function the liftgate in power mode.

### **EASY ENTRY (if equipped)**

This feature automatically moves the driver's seat backwards for easy exit/entry from the vehicle.

Press the RESET button to turn the easy entry/exit seat on or off.

### **AIR SUSPENSION (if equipped)**

Before disabling the air suspension, make sure the liftgate and liftgate glass are in the closed position.

With the vehicle in P (Park), press RESET to turn the air suspension off or on.

### **REAR PARK AID (if equipped)**

This feature sounds a warning tone to warn the driver of obstacles near the rear bumper, and functions only when R (Reverse) gear is selected.

To disable/enable park aid, press RESET when reaching this menu from the setup sequence or put the vehicle in R (Reverse) and press RESET.

### **TRAILER SWAY (if equipped)**

This feature uses the electronic stability control to mitigate trailer sway, Press the RESET button to turn trailer sway on or off.

### **CREATE MYKEY / MYKEY SETUP / CLEAR MYKEY**

For more information refer to *MyKey™* in the *Locks and Security* chapter.

### **COMPASS**

The compass heading is displayed as one of N, NE, E, SE, S, SW, W and NW in the message center display.

The compass reading may be affected when you drive near large buildings, bridges, power lines and powerful broadcast antenna. Magnetic or metallic objects placed in, on or near the vehicle may also affect compass accuracy.

Usually, when something affects the compass readings, the compass will correct itself after a few days of operating your vehicle in normal conditions. If the compass still appears to be inaccurate, a manual calibration may be necessary. Refer to *Compass zone/calibration adjustment*.

## Instrument Cluster

Most geographic areas (zones) have a magnetic north compass point that varies slightly from the northerly direction on maps. This variation is four degrees between adjacent zones and will become noticeable as the vehicle crosses multiple zones. A correct zone setting will eliminate this error. Do the following to set the proper zone:

### *Compass zone/calibration adjustment*

1. Determine your magnetic zone by referring to the zone map.
2. Start the engine.
3. Press SETUP to reach the reset for zone setting screen.
4. Press and hold RESET until the message center display prompts you to reset the current zone setting. Press RESET.

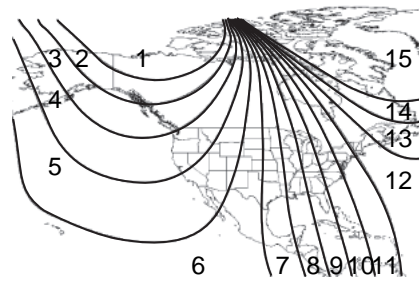

5. Press and release RESET until the message center display changes to show the current zone setting (XX).
6. Press and release the RESET button repeatedly until the correct zone setting for your geographic location is displayed on the message center. The range of zone values are from 1 to 15 and “wraps” back to 1.
7. To exit the zone setting mode, and to “lock in” your change:
  - press and release SETUP or,
  - press INFO to exit or,
  - wait four seconds and the zone will be “locked in”.

Perform compass calibration in an open area free from steel structures and high voltage lines. For optimum calibration, turn off all electrical accessories (heater/air conditioning, wipers, etc.) and make sure all vehicle doors are shut.

8. Press RESET to start the compass calibration function.
9. Slowly drive the vehicle in a circle (less than 3 mph [5 km/h]) until the CIRCLE SLOWLY TO CALIBRATE display changes to CALIBRATION COMPLETED. It will take up to five circles to complete calibration.
10. The compass is now calibrated.

**Note:** If the RESET button is pressed or three minutes has expired, the display will go back to the INFO menu and will show CAL instead of the compass heading until the compass is calibrated.

## Instrument Cluster

### **ENGLISH / FRENCH / SPANISH RESET FOR NEW**

Allows you to choose which language the message center will display in. Selectable languages are English, Spanish, or French.

Press RESET to cycle through each of the language choices.

Press and hold RESET for two seconds to set the language choice.

### **System warnings**

System warnings alert you to possible problems or malfunctions in your vehicle's operating systems.

In the event of a multiple warning situation, the message center will cycle the display to show all warnings by displaying each one for four seconds.

The message center will display the last selected feature if there are no more warning messages.

Types of messages and warnings:

- Some messages will appear briefly to inform you of something you may need to take action on or be informed of.
- Some messages will appear once and then again when the vehicle is restarted.
- Some messages will reappear after clearing or being reset if a problem or condition is still present and needs your attention.
- Some messages can be acknowledged and reset by pressing RESET. This allows you to use the full message center functionality by clearing the message.

**DRIVER DOOR AJAR** — Displayed when the driver door is not completely closed.

**PASSENGER DOOR AJAR** — Displayed when the passenger door is not completely closed.

**REAR LEFT DOOR AJAR** — Displayed when the rear left door is not completely closed.

**REAR RIGHT DOOR AJAR** — Displayed when the rear right door is not completely closed.

**LIFTGATE / GLASS AJAR** — Displayed when the liftgate or liftgate glass is not completely closed.

## Instrument Cluster

**CHECK CHARGING SYSTEM** — Displayed when the electrical system is not maintaining proper voltage when the engine is running. If you are operating electrical accessories when the engine is idling at a low speed, turn off as many of the electrical loads as soon as possible. If the warning stays on or comes on when the engine is operating at normal speeds, contact your authorized dealer as soon as possible.

**CHECK FUEL FILL INLET** — Displayed when the fuel fill inlet may not be properly closed. Refer to *Easy Fuel™ “no cap” fuel system* in the *Maintenance and Specifications* chapter.

**TIRE PRESSURE SENSOR FAULT** — Displayed when a tire pressure sensor is malfunctioning, or your spare tire is in use. For more information on how the system operates under these conditions, refer to *Understanding Your Tire Pressure Monitoring System (TPMS)* in the *Tires, Wheels and Loading* chapter. If the warning stays on or continues to come on, contact your authorized dealer as soon as possible.

**LOW TIRE PRESSURE** — Displayed when one or more tires on your vehicle have low tire pressure. Refer to *Inflating your tires* in the *Tires, Wheels and Loading* chapter.

**TIRE PRESSURE MONITOR FAULT** — Displayed when the Tire Pressure Monitoring System is malfunctioning. If the warning stays on or continues to come on, contact your authorized dealer as soon as possible.

**AIR SUSPENSION OFF (if equipped)** — Displayed when the air suspension is off. For more information, refer to *Air suspension system* in the *Driving* chapter.

**BRAKE FLUID LEVEL LOW** — Indicates the brake fluid level is low and the brake system should be inspected immediately. Refer to *Brake fluid* in the *Maintenance and Specifications* chapter.

**WASHER FLUID LEVEL LOW** — Indicates the washer fluid reservoir is less than one quarter full. Check the washer fluid level. Refer to *Windshield washer fluid* in the *Maintenance and Specifications* chapter.

**ENGINE OIL CHANGE SOON** — Displayed when the engine oil life remaining is 10% or less.

**OIL CHANGE REQUIRED** — Displayed when the oil life left reaches 0%.

## Instrument Cluster

**CHECK AIR SUSPENSION (if equipped)** — Displayed when the air suspension system is not operating properly. If this message is displayed while driving, pull off the road as soon as safely possible. For more information, refer to *Air suspension system* in the *Driving* chapter.

**CHECK PARK AID (if equipped)** — Displayed when the transmission is in R (Reverse). Refer to *Reverse sensing system* in the *Driving* chapter.

**CHECK BRAKE SYSTEM** — Displayed when the braking system is not operating properly. If the warning stays on or continues to come on, contact your authorized dealer as soon as possible.

**XXX MILES TO E FUEL LEVEL LOW** — Displayed as an early reminder of a low fuel condition.

**PARK BRAKE ENGAGED** — Displayed when the parking brake is set, the engine is running and the vehicle is driven more than 3 mph (5 km/h). If the warning stays on after the parking brake is released, contact your authorized dealer as soon as possible.

**TRAILER SWAY REDUCE SPEED (if equipped)** — Displayed when the trailer sway control has detected trailer sway. For more information, refer to the *Driving* chapter for more information.

**4X4 SHIFT IN PROGRESS (if equipped)** — Displayed when the 4X4 system is making a shift. For more information, refer to *Control Trac® four-wheel drive (4X4) operation* in the *Driving* chapter.

**FOR 4X4 LOW SLOW TO 3 MPH (if equipped)** — Displayed when 4X4 LOW is selected while the vehicle is moving. For more information, refer to *Control Trac® four-wheel drive (4X4) operation* in the *Driving* chapter.

**FOR 4X4 LOW SHIFT TO N (if equipped)** — Displayed when 4X4 LOW is selected and the vehicle is stopped. For more information, refer to *Control Trac® four-wheel drive (4X4) operation* in the *Driving* chapter.

**TO EXIT 4X4 LOW SLOW TO 3 MPH (if equipped)** — Displayed when 2WD is selected while the vehicle is operating in 4X4 LOW. For more information, refer to *Control Trac® four-wheel drive (4X4) operation* in the *Driving* chapter.

**TO EXIT 4X4 LOW SHIFT TO N (if equipped)** — Displayed when 2WD is selected while the vehicle has been stopped in 4X4 LOW. For more information, refer to *Control Trac® four-wheel drive (4X4) operation* in the *Driving* chapter.

## Instrument Cluster

**SHIFT DELAYED PULL FORWARD (if equipped)** — May display when shifting to or from 4X4 LOW. For more information, refer to *Control Trac® four-wheel drive (4X4) operation* in the *Driving* chapter.

**MYKEY ACTIVE DRIVE SAFELY** — Displayed at startup when MyKey™ is in use. Refer to *MyKey™* in the *Locks and Security* chapter for more information.

**KEY COULD NOT PROGRAM** — Displayed when an attempt is made to program a spare key using two existing MyKeys. Refer to *MyKey™* in the *Locks and Security* chapter for more information.

**VEHICLE SPEED 80 MPH MAX** — Displayed when a MyKey™ is in use and the Admin has enabled the MyKey speed limit and the vehicle speed is 80 mph (130 km/h). Refer to *MyKey™* in the *Locks and Security* chapter for more information.

**SPEED LIMITED TO 80 MPH** — Displayed when starting the vehicle and MyKey™ is in use and the MyKey speed limit is on. Refer to *MyKey™* in the *Locks and Security* chapter for more information.

**CHECK SPEED DRIVE SAFELY** — Displayed when a MyKey™ is in use and the optional setting is on and the vehicle exceeds a preselected speed. Refer to *MyKey™* in the *Locks and Security* chapter for more information.

**VEHICLE NEAR TOP SPEED** — Displayed when a MyKey™ is in use and the MyKey speed limit is on and the vehicle speed is approaching 80 mph (130 km/h). Refer to *MyKey™* in the *Locks and Security* chapter for more information.

**TOP SPEED MYKEY SETTING** — Displayed when a MyKey™ is in use and the MyKey speed limit is on and the vehicle speed is 80 mph (130 km/h). Refer to *MyKey™* in the *Locks and Security* chapter for more information.

**BUCKLE UP TO UNMUTE AUDIO** — Displayed when a MyKey™ is in use and Belt-Minder® is activated. Refer to *MyKey™* in the *Locks and Security* chapter for more information.

**ADVTRAC ON MYKEY SETTING** — Displayed when a MyKey™ is in use when trying to disable the AdvanceTrac® system and the optional setting is on. Refer to *MyKey™* in the *Locks and Security* chapter for more information.

**SERVICE ADVANCETRAC** — Displayed when the AdvanceTrac® system has detected a condition that requires service. Contact your authorized dealer as soon as possible.

## Entertainment Systems

### AUDIO SYSTEMS

#### AM/FM single CD/MP3 satellite compatible sound system (if equipped)

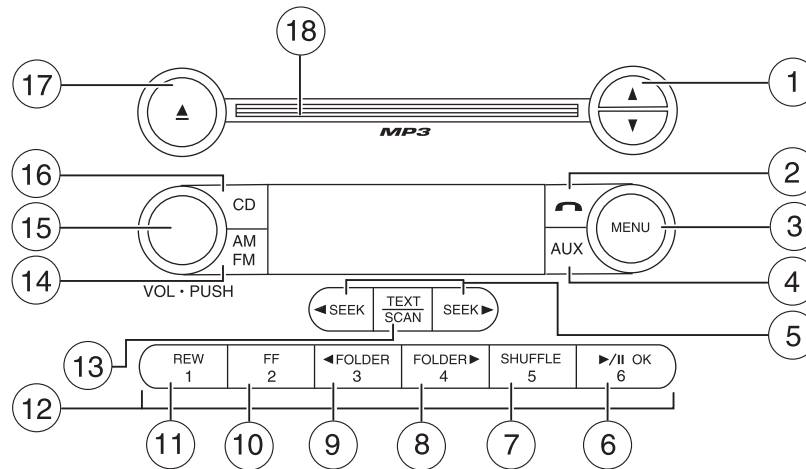

**WARNING:** Driving while distracted can result in loss of vehicle control, accident and injury. Ford strongly recommends that drivers use extreme caution when using any device or feature that may take their focus off the road. Your primary responsibility is the safe operation of the vehicle. We recommend against the use of any handheld device while driving and that you comply with all applicable laws.

**Accessory delay:** Your vehicle is equipped with accessory delay. With this feature, the window switches, radio and moon roof (if equipped) may be used for up to ten minutes after the ignition is turned off or until either front door is opened.

#### 1. ▲ / ▼ (Tuner):

**In radio mode,** press to manually go up ▲ or down ▼ the radio frequency. Press and hold for a fast advance through radio frequencies.

**In menu mode,** use to select various settings.



## Entertainment Systems

**In satellite radio mode (if equipped)**, press ▲ / ▼ to scroll through the SIRIUS channels.

*Satellite radio is available only with a valid SIRIUS® radio subscription. Check with your authorized dealer for availability.*

2. **PHONE** (Phone): Press to access SYNC® phone features if your vehicle is equipped with SYNC®.



Refer to the SYNC® supplement for more information. If your vehicle is not equipped with SYNC®, the display will read NO PHONE.

3. **MENU**: Press repeatedly to access the following settings:



**SATELLITE RADIO MENU (if equipped)**: Press MENU when satellite radio mode is active to access. Press OK to enter into the satellite radio menu. Press ▲ / ▼ to cycle through the following options:

- **CATEGORY**: Press OK to enter category mode. Press ▲ / ▼ to scroll through the list of available SIRIUS® channel categories (Pop, Rock, News, etc.) Press OK when the desired category appears in the display. After a category is selected, press SEEK to search for that specific category of channels only (i.e. ROCK). You may also select CATEGORY ALL to seek all available SIRIUS® categories and channels. Press OK to close and return to the main menu.
- **SAVE SONG**: Press OK to save the currently playing song in the system's memory. (If you try to save something other than a song, CANT SAVE will appear in the display.) When the chosen song is playing on any satellite radio channel, the system will alert you with an audible prompt. Press OK while SONG ALERT is in the display and the system will take you to the channel playing the desired song. You can save up to 20 songs. If you attempt to save a song when the system is full, the display will read REPLACE SONG? Press OK to access the saved songs and press ▲ / ▼ to cycle through the saved songs. When the song appears in the display that you would like to replace, press OK. SONG REPLACED will appear in the display.



## Entertainment Systems

- **DELETE SONG:** Press OK to delete a song from the system's memory. Press ▲ / ▼ to cycle through the saved songs. When the song appears in the display that you would like to delete, press OK. The song will appear in the display for confirmation. Press OK again and the display will read SONG DELETED. If you do not want to delete the currently listed song, press ▲ / ▼ to select either RETURN or CANCEL.  
**Note:** If there are no songs presently saved, the display will read NO SONGS.
- **DELETE ALL SONGS:** Press OK to delete all song's from the system's memory. The display will read ARE YOU SURE ? Press OK to confirm deletion of all saved songs and the display will read ALL DELETED.  
**Note:** If there are no songs presently saved, the display will read NO SONGS.
- **ENABLE ALERTS / DISABLE ALERTS:** Press OK to enable/disable the satellite alert status which alerts you when your selected songs are playing on a satellite radio channel. (The system default is disabled.) SONG ALERTS ENABLED/DISABLED will appear in the display. The menu listing will display the opposite state. For example, if you have chosen to enable the song alerts, the menu listing will read DISABLE as the alerts are currently on, so your other option is to turn them off.

*Satellite radio is available only with a valid SIRIUS® radio subscription. Check with your authorized dealer for availability.*

**Setting the clock:** Press MENU until SELECT HOUR or SELECT MINS is displayed. Use ▲ / ▼ to adjust hours/minutes. Press OK to close and return to the main menu.

**AUTOSET:** In radio mode, press MENU until the display reads AUTOSET. Autoset allows you to set the strongest local radio stations without losing your original manually set preset stations for AM/FM1/FM2. Use ▲ / ▼ / ◀ SEEK, SEEK ▶ to turn on/off. Press OK to close and return to the main menu. When the six strongest stations are filled, the station stored in preset 1 will begin playing. If there are less than six strong stations, the system will store the last one in the remaining presets.

**RBDS:** Available only in FM mode. This feature allows you to display text transmitted by RBDS-equipped stations and to search for a certain category of music format: CLASSIC, COUNTRY, INFORM, JAZZ/RB, ROCK, etc.

## Entertainment Systems

**To activate**, press MENU repeatedly until RBDS (ON/OFF) appears in the display. Use ▲ / ▼ / ◀ SEEK ▶ to toggle RBDS ON/OFF. (When RBDS is OFF, you will not be able to search for RBDS equipped stations or view the station name or type.)

**To search for specific RBDS music categories:** When the desired category appears in the display, press ▲ / ▼ to find the desired type, then press and release ◀ SEEK, SEEK ▶ or press and hold SCAN to begin the search.

**To view the station name or type:** With RBDS ON, press TEXT/SCAN to toggle between displaying the station type (COUNTRY, ROCK, etc.) or the station name (WYCD, WXYZ, etc.).

**BASS:** Press MENU to reach the bass setting. Use ▲ / ▼ / ◀ SEEK, SEEK ▶ to adjust. Press OK to close and return to the main menu.

**TREB (Treble):** Press MENU to reach the treble setting. Use ▲ / ▼ / ◀ SEEK, SEEK ▶ to adjust. Press OK to close and return to the main menu.

**BAL (Balance):** Press MENU to reach the balance setting. Use ▲ / ▼ / ◀ SEEK, SEEK ▶ to adjust the audio between the left (L) and right (R) speakers. Press OK to close and return to the main menu.

**FADE:** Press MENU to reach the fade setting. Use ▲ / ▼ / ◀ SEEK, SEEK ▶ to adjust the audio between the back (B) and front (F) speakers. Press OK to close and return to the main menu.

**SPEEDVOL (Speed sensitive volume):** Press MENU to reach the SPEEDVOL setting. Radio volume automatically gets louder with increasing vehicle speed to compensate for road and wind noise.

Use ▲ / ▼ / ◀ SEEK, SEEK ▶ to adjust. Press OK to close and return to the main menu.

The default setting is *off*; increasing your vehicle speed will not change the volume level.

Adjust 1–7: Increasing this setting from 1 (lowest setting) to 7 (highest setting) allows the radio volume to automatically change slightly with vehicle speed to compensate for road and wind noise.

Recommended level is 1–3; SPEED OFF turns the feature off and level 7 is the maximum setting.

## Entertainment Systems

**Track/Folder mode:** Available only on MP3 discs in CD mode. In Track mode, pressing ◀ SEEK, SEEK ▶ will scroll through all tracks on the disc

In Folder mode, pressing ◀ SEEK, SEEK ▶ will scroll only through tracks within the selected folder.

Press ◀ FOLDER, FOLDER ▶ to access the previous/next folder (if available). Press OK to close and return to the main menu.

**COMPRESS (Compression):** Available only in CD/MP3 mode. Press MENU until COMPRESS ON/OFF appears in the display.

Use ▲ /▼ /◀ SEEK, SEEK ▶ to toggle ON/OFF. When COMPRESS is ON, the system will bring the soft and loud CD passages together for a more consistent listening level. Press OK to close and return to the main menu.

**SINGLE PLAY / DUAL PLAY:** If Single Play is ON, press ▲ /▼ for Dual Play. For further information on Single Play/Dual Play, refer to *Rear seat controls* later in this chapter.

**FES (FULL/LOCKED):** Your vehicle is equipped with a Family Entertainment DVD system. For further information on the DVD system, refer to *Family Entertainment DVD system* later in this section.

4. **AUX:** Press repeatedly to cycle through FES/DVD (if equipped)



LINE IN (Auxiliary audio) , SAT1,

SAT2, SAT3 (satellite radio modes, if equipped) and SYNC®.

For location and further information on the auxiliary audio mode, refer to *Auxiliary input jack* later in this chapter.

*Satellite radio is available only with a valid SIRIUS® subscription. Check with your authorized dealer for availability.*

5. **SEEK: In radio mode,**

press ◀ /▶ to access the previous/next strong station.



**In CD/MP3 mode,** press ◀ /▶ to access the previous/next CD/MP3 track.

**In satellite radio mode (if equipped),** press ◀ SEEK, SEEK ▶ to seek to the previous/next channel.

## Entertainment Systems

In **CATEGORY MODE**, press ◀ SEEK, SEEK ▶ to select a category (Jazz, Rock, News, etc.). Once the desired category is in the display, press ◀ SEEK, SEEK ▶ to seek to the previous/next channel in the selected category. Press and hold ◀ SEEK, SEEK ▶ to fast seek through the previous /next channels.

In **TEXT MODE**, press ◀ SEEK, SEEK ▶ to view the previous/additional display text.

*Satellite radio is available only with a valid SIRIUS® radio subscription. Check with your authorized dealer for availability.*

6. ▶ / || **OK(Play/Pause)**: This

control is operational in CD and DVD mode (if equipped). When a CD or DVD is playing in the FES system, press this control to play or pause the current CD/DVD. The CD/DVD status will display in the radio display.



**OK**: Use in various menu selections.

If your vehicle is equipped with a Family Entertainment System (FES) please refer to the *Family Entertainment DVD system* later in this chapter.

7. **SHUFFLE**: In CD/MP3 mode, press SHUFFLE to engage shuffle mode. SHUFFLE ON will appear in

the display. If you wish to engage shuffle mode right away, press SEEK to begin random play. Otherwise, random play will begin when the current track is finished playing. CD SHUF will appear in the display. To disengage, press SHUFFLE again. SHUFFLE OFF will appear in the display.

**Note**: In CD/MP3 mode, press SHUFFLE to play the tracks in random order. In MP3 folder mode, the system will randomly play all tracks within the current folder.

8. **FOLDER ▶** : In folder mode, press FOLDER ▶ to access next folder on MP3 discs, if available.



9. ◀ **FOLDER**: In folder mode, press ◀ FOLDER to access the previous folder on MP3 discs, if available.



## Entertainment Systems

10. **FF (Fast forward):** In CD mode, press FF to manually advance in a track.



In DVD mode (if equipped), press and hold to advance through the current chapter.

11. **REW (Rewind):** In CD mode, press REW to manually reverse in a track.



In DVD mode (if equipped), press and hold to reverse through the current chapter.

12. **Memory presets:** To set a station, select the desired frequency band, AM, FM1 or FM2. Tune to the desired station. Press and hold a preset button until sound returns and PRESET # SAVED appears in the display. You can save up to 18 stations, six in AM, six in FM1 and FM2.



**In satellite radio mode (if equipped),** there are 18 available presets, six each for SAT1, SAT2 and SAT3. To save satellite channels in your memory presets, tune to the desired channel then press and hold a preset control until sound returns.

*Satellite radio is available only with a valid SIRIUS® radio subscription. Check with your authorized dealer for availability.*

13. **TEXT/SCAN: In radio and CD/MP3 mode,** press and hold for a brief sampling of radio stations or CD tracks. Press again to stop.



**In MP3 mode,** press and release to display song title, artist name, and album title.

**In TEXT MODE** sometimes the display requires additional text to be displayed. When the “>” indicator is active, press TEXT/SCAN and then SEEK ► to view the additional display text. When the “<” indicator is active, press TEXT/SCAN and then ◀ SEEK to view the previous display text.

**In satellite radio mode (if equipped),** press and release to enter TEXT MODE and display the current song title. While in TEXT MODE, press again to scroll through the current song title, artist, channel category and the SIRIUS long channel name. Press and hold to hear a brief sampling of the next channels. Press again to stop.

## Entertainment Systems

In **CATEGORY MODE**, press SCAN to hear a brief sampling of the channels in the selected category. Press again to stop.  
*Satellite radio is available only with a valid SIRIUS® radio subscription. Check with your authorized dealer for availability.*

14. **AM/FM:** Press to select AM/FM1/FM2 frequency band.



15. **ON/OFF/Volume:** Press VOL-PUSH to turn ON/OFF. Turn VOL-PUSH to increase/decrease volume.



**Note:** If the volume is set above a certain level and the ignition is turned off, the volume will come back on at a “nominal” listening level when the ignition switch is turned back on.

16. **CD:** Press to enter CD mode. If a CD is already loaded into the system, CD play will begin where it ended last. If no CD is loaded, NO DISC will appear in the display.



17. **CD eject:** Press to eject a CD.



18. **CD slot:** Insert a CD label side up.



### Auxiliary input jack (Line in)



**WARNING:** Driving while distracted can result in loss of vehicle control, accident and injury. Ford strongly recommends that drivers use extreme caution when using any device or feature that may take their focus off the road. Your primary responsibility is the safe operation of the vehicle. We recommend against the use of any handheld device while driving and that you comply with all applicable laws.

## Entertainment Systems

Your vehicle is equipped with an Auxiliary Input Jack (AIJ) located inside the center console. The Auxiliary Input Jack provides a way to connect your portable music player to the in-vehicle audio system. This allows the audio from a portable music player to be played through the vehicle speakers with high fidelity. To achieve optimal performance, please observe the following instructions when attaching your portable music device to the audio system. If your vehicle is equipped with a navigation system, refer to *Auxiliary input jack* section in the *Audio Features* chapter of your *Navigation System* supplement.

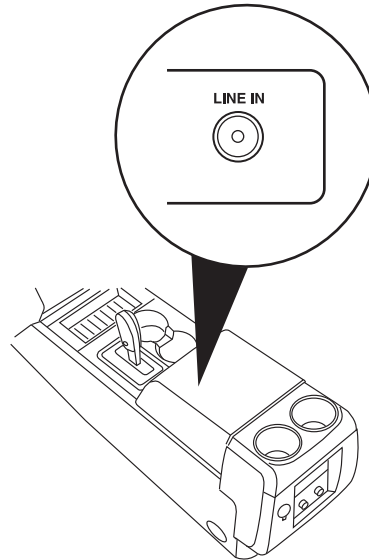

### **Required equipment:**

1. Any portable music player designed to be used with headphones
2. An audio extension cable with stereo male 1/8 in. (3.5 mm) connectors at each end

### **To play your portable music player using the auxiliary input jack:**

1. Begin with the vehicle parked and the radio turned off.
2. Ensure that the battery in your portable music player is new or fully charged and that the device is turned off.
3. Attach one end of the audio extension cable to the headphone output of your player and the other end of the audio extension cable to the AIJ in your vehicle.
4. Turn the radio on, using either a tuned FM station or a CD loaded into the system. Adjust the volume to a comfortable listening level.
5. Turn the portable music player on and adjust the volume to 1/2 the volume.
6. Press AUX on the vehicle radio repeatedly until LINE, LINE IN or SYNC LINE IN appears in the display. You should hear audio from your portable music player although it may be low.

## Entertainment Systems

7. Adjust the sound on your portable music player until it reaches the level of the FM station or CD by switching back and forth between the AUX and FM or CD controls.

### Troubleshooting:

1. Do not connect the audio input jack to a line level output. Line level outputs are intended for connection to a home stereo and are not compatible with the AIJ. The AIJ will only work correctly with devices that have a headphone output with a volume control.
2. Do not set the portable music player's volume level higher than is necessary to match the volume of the CD or FM radio in your audio system as this will cause distortion and will reduce sound quality. Many portable music players have different output levels, so not all players should be set at the same levels. Some players will sound best at full volume and others will need to be set at a lower volume.
3. If the music sounds distorted at lower listening levels, turn the portable music player volume down. If the problems persists, replace or recharge the batteries in the portable music player.
4. The portable music player must be controlled in the same manner when it is used with headphones as the AIJ does not provide control (play, pause, etc.) over the attached portable music player.
5. For safety reasons, connecting or adjusting the settings on your portable music player should not be attempted while the vehicle is moving. Also, the portable music player should be stored in a secure location, such as the center console or the glove box, when the vehicle is in motion. The audio extension cable must be long enough to allow the portable music player to be safely stored while the vehicle is in motion.

### USB port (if equipped)



**WARNING:** Driving while distracted can result in loss of vehicle control, accident and injury. Ford strongly recommends that drivers use extreme caution when using any device or feature that may take their focus off the road. Your primary responsibility is the safe operation of the vehicle. We recommend against the use of any handheld device while driving and that you comply with all applicable laws.



## Entertainment Systems

Your vehicle may be equipped with a USB port inside your center console. This feature allows you to plug in media playing devices, memory sticks, and also to charge devices if they support this feature. For further information on this feature, refer to *Accessing and using your USB port* in the *SYNC®* supplement or *Navigation System* supplement.

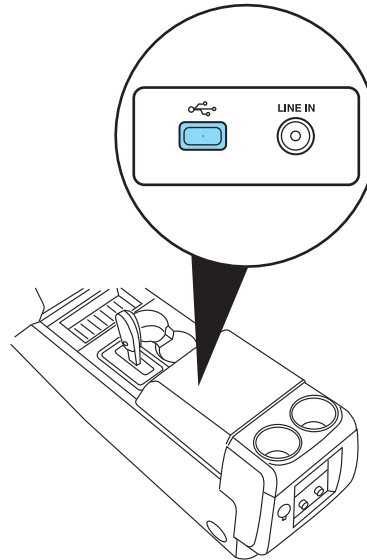

### Rear seat controls (if equipped)

Your vehicle is equipped with rear seat radio controls. This feature allows front and middle seat passengers to listen to different media sources (radio, CD, SYNC or DVD) simultaneously; however, the front and middle-seat passengers cannot listen to two different radio stations at the same time.

1. **MEDIA:** Push repeatedly to cycle through available playing medias such as AM, FM1, FM2, CD, SAT1, SAT2, SAT3 (satellite radio if equipped), DVD (if equipped) and SYNC® (if equipped). If in Dual Play mode, SHARED illuminates in the radio display when the front and rear modes are set to the same media.

**Note:** After pressing the media button to select SYNC mode, press + or - to scroll through the different SYNC® options: (SYNC USB, SYNC BTST and SYNC LINE). For more information on SYNC® operation, see your *SYNC®* supplement.

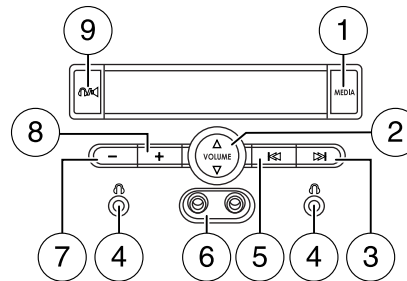

## Entertainment Systems

2. **VOLUME:** Press  $\Delta$  to increase or  $\nabla$  to decrease the volume level in the headphones.

From the rear seat controls, volume control can be set no higher than the current radio setting unless the speakers are turned off.

3. **▶▶▶** : In radio mode, press and release to scroll through memory presets. Press and hold to seek to the next station.  
In CD mode, press and release to advance to the next track. Press and hold to fast forward within that track.  
In SYNC modes, press and release to advance to the next track. Press and hold to fast forward within that track.

### 4. Wired headphone jacks

5. **◀◀◀** : In radio mode, press and release to scroll through memory presets. Press and hold to seek to the next station.  
In CD mode, press and release to advance to the next track. Press and hold for a fast reverse within that track.  
In SYNC modes, press and release to advance to the next track. Press and hold for a fast reverse within that track.

6. **Auxiliary audio input jack:** Use to plug in and play auxiliary audio sources.

7. **-**: In CD mode, press to access the previous CD.

8. **+**: In CD mode, press to access the next CD.

9. **🔊 / 🔊** : Press to turn the rear speakers on (Single Play mode) or off (Dual Play mode).

### Parental control

The multimedia system allows for three varying levels of parental control over rear-seat controls. By simultaneously pressing the 3 and 5 buttons, the rear passengers may be allowed to access FULL or LOCAL control or be LOCKED out of rear seat controls altogether.



After the ignition has been turned on, the rear seat passengers have FULL control over the audio system. This means that while in single play mode, the rear seat passengers can fully control the audio system from the rear controls (including volume, media selection and seek adjustments).

## Entertainment Systems

Simultaneously press 3 and 5 to restrict the rear passengers control to LOCAL media. While in dual play mode, this means that only media which is played through the auxiliary input jacks, or media which has been selected at the radio by the driver can be accessed by the rear passengers. Press 3 and 5 a second time to LOCK the rear passenger controls completely; all media access is removed from the rear passengers. Press 3 and 5 a third time to complete the cycle and allow full control to the rear passenger again.

### To activate the rear seat radio controls:

- After the ignition has been turned on, FULL rear controls are active and the system is in single play mode. 
- Press the memory preset controls 3 and 5 at the same time. The word LOCAL will illuminate in the radio display and on the rear display, indicating that only LOCAL rear control is available. **Note:** While in single play mode, LOCAL is the same as LOCKED. In dual play mode, LOCAL allows control of media which the driver has selected at the radio, or over media played through the rear auxiliary input jacks.)
- Press the 3 and 5 buttons a second time and the rear control will be LOCKD (locked). In this state, the rear passenger is restricted from control over media of any kind, the rear controls are disabled. **Note:** If in dual play mode, the headphone icon normally illuminated in the radio display when in dual play, will turn off in the radio display.
- Press the 3 and 5 buttons a third time and full control will be restored to the rear seat controls. Turning the ignition off and then on again will have the same effect.

### To activate dual play mode (rear seat passengers listen to a different playing media than the front seat passengers):

- Press the speaker/headphone control. A head phone icon () will illuminate in the radio display and in the rear display, indicating the rear seat speakers have been disabled and headphones are now active. This is dual play mode.
- Press the MEDIA Control to change audio sources (for headphone mode only)
- Use the other controls to make adjustments to the playing media.

## Entertainment Systems

- Dual Play mode may also be activated by simultaneously pressing memory presets 2 and 4 located on the radio.



The rear speakers are muted and rear seat passengers can listen to the selected media through their headphones.

### To deactivate dual play mode:

- Press the 2 and 4 buttons simultaneously again.
- Press the headphone/speaker button again
- Press the 3 and 5 buttons simultaneously until the rear seat controls are LOCKED.

Using any of these methods, the headphone icon will turn off in both displays (front and rear), the rear speaker sound will be restored and the headphone jacks will be disabled.

### Using headphones/dual play mode



**WARNING:** Do not leave children unattended in the vehicle and do not let children operate the system while unsupervised. If wired headphones or auxiliary systems are used, children may become entangled in the cords and seriously injure themselves.

Plug a 3.5 mm headphone (not included) into the  jack. Press the speaker button, or the 2/4 preset buttons simultaneously on the radio to activate the headphones. The words DUAL PLAY will illuminate on the radio display, sound will no longer be heard from the rear speakers and the fade control will be disabled, signaling that Dual Play has been activated.

The front speakers remain playing for the front passengers. Press the speaker button, or the 2/4 preset buttons simultaneously on the radio again to deactivate the headphones and dual play mode. The words SINGLE PLAY will illuminate on the radio display and fade control and sound from rear speakers will be restored, signaling that dual play mode has been deactivated.

To use any rear controls, whether in single or dual play mode, the rear seat controls must be active. To enable dual play, the rear seat controls must be active and  illuminated in the radio display. See *To activate the rear seat radio controls* previously.

## Entertainment Systems

### GENERAL AUDIO INFORMATION

#### Radio frequencies:

AM and FM frequencies are established by the Federal Communications Commission (FCC) and the Canadian Radio and Telecommunications Commission (CRTC). Those frequencies are:

AM: 530, 540–1700, 1710 kHz

FM: 87.7, 87.9–107.7, 107.9 MHz

#### Radio reception factors:

There are three factors that can affect radio reception:

- Distance/strength: The further you travel from an FM station, the weaker the signal and the weaker the reception.
- Terrain: Hills, mountains, tall buildings, power lines, electric fences, traffic lights and thunderstorms can interfere with your reception.
- Station overload: When you pass a broadcast tower, a stronger signal may overtake a weaker one and play while the weak station frequency is displayed.

#### CD/CD player care

Do:

- Handle discs by their edges only. (Never touch the playing surface).
- Inspect discs before playing.
- Clean only with an approved CD cleaner.
- Wipe discs from the center out.



## Entertainment Systems

Don't:

- Expose discs to direct sunlight or heat sources for extended periods of time.
- Clean using a circular motion.

**CD units are designed to play commercially pressed 4.75 in (12 cm) audio compact discs only. Due to technical incompatibility, certain recordable and re-recordable compact discs may not function correctly when used in Ford CD players.**

**Do not use any irregular shaped CDs or discs with a scratch protection film attached.**



**CDs with homemade paper (adhesive) labels should not be inserted into the CD player as the label may peel and cause the CD to become jammed. It is recommended that homemade CDs be identified with permanent felt tip marker rather than adhesive labels. Ballpoint pens may damage CDs. Please contact your authorized dealer for further information.**

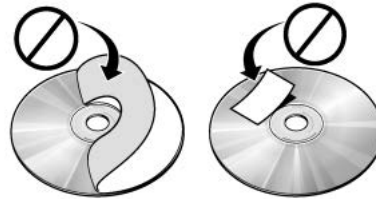

### **Audio system warranty and service**

Refer to the *Warranty Guide* for audio system warranty information. If service is necessary, see your dealer or qualified technician.

### **MP3 track and folder structure**

Your MP3 system recognizes MP3 individual tracks and folder structure as follows:

- There are two different modes for MP3 disc playback: MP3 track mode (system default) and MP3 folder mode. For more information on track and folder mode, refer to *Sample MP3 structure* in the following section.

## Entertainment Systems

- MP3 track mode ignores any folder structure on the MP3 disc. The player numbers each MP3 track on the disc (noted by the .mp3 file extension) from T001 to a maximum of T255.  
**Note:** The maximum number of playable MP3 files may be less depending on the structure of the CD and exact model of radio present.
- MP3 folder mode represents a folder structure consisting of one level of folders. The CD player numbers all MP3 tracks on the disc (noted by the .mp3 file extension) and all folders containing MP3 files, from F001 (folder) T001 (track) to F253 T255.
- Creating discs with only one level of folders will help with navigation through the disc files.

### Sample MP3 structure

If you are burning your own MP3 discs, it is important to understand how the system will read the structures you create. While various files may be present, (files with extensions other than mp3), only files with the .mp3 extension will be played. Other files will be ignored by the system. This enables you to use the same MP3 disc for a variety of tasks on your work computer, home computer and your in-vehicle system.

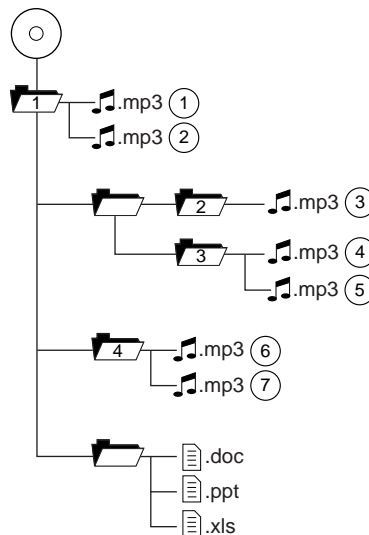

In track mode, the system will display and play the structure as if it were only one level deep (all .mp3 files will be played, regardless of being in a specific folder). In folder mode, the system will only play the .mp3 files in the current folder.

## Entertainment Systems

### Satellite radio information (if equipped)

**Satellite radio channels:** SIRIUS® broadcasts a variety of music, news, sports, weather, traffic and entertainment satellite radio channels. For more information and a complete list of SIRIUS® satellite radio channels, visit [www.sirius.com](http://www.sirius.com) in the United States, [www.sirius-canada.ca](http://www.sirius-canada.ca) in Canada, or call SIRIUS® at 1-888-539-7474.

**Satellite radio reception factors:** To receive the satellite signal, your vehicle has been equipped with a satellite radio antenna located on the roof of your vehicle. The vehicle roof provides the best location for an unobstructed, open view of the sky, a requirement of a satellite radio system. Like AM/FM, there are several factors that can affect satellite radio reception performance:

- **Antenna obstructions:** For optimal reception performance, keep the antenna clear of snow and ice build-up and keep luggage and other material as far away from the antenna as possible.
- **Terrain:** Hills, mountains, tall buildings, bridges, tunnels, freeway overpasses, parking garages, dense tree foliage and thunderstorms can interfere with your reception.
- **Station overload:** When you pass a ground based broadcast repeating tower, a stronger signal may overtake a weaker one and result in an audio mute.

Unlike AM/FM audible static, you will hear an audio mute when there is a satellite radio signal interference. Your radio display may display NO SIGNAL to indicate the interference.

**SIRIUS® satellite radio service:** SIRIUS® satellite radio is a subscription based satellite radio service that broadcasts music, sports, news and entertainment programming. A service fee is required in order to receive SIRIUS® service. Vehicles that are equipped with a factory installed SIRIUS® satellite radio system include hardware and a limited subscription term, which begins on the date of sale or lease of the vehicle.

For information on extended subscription terms, the online media player and other SIRIUS® features, please contact SIRIUS® at 1-888-539-7474.

**Note:** SIRIUS® reserves the unrestricted right to change, rearrange, add or delete programming including canceling, moving or adding particular channels, and its prices, at any time, with or without notice to you. Ford Motor Company shall not be responsible for any such programming changes.



## Entertainment Systems

**Satellite radio electronic serial number (ESN):** This 12-digit Satellite Serial Number is needed to activate, modify or track your satellite radio account. You will need this number when communicating with SIRIUS®. While in satellite radio mode, you can view this number on the radio display by pressing the AUX and preset 1 controls simultaneously.

Radio Display	Condition	Action Required
ACQUIRING	Radio requires more than two seconds to produce audio for the selected channel.	No action required. This message should disappear shortly.
SAT FAULT	Internal module or system failure present.	If this message does not clear within a short period of time, or with an ignition key cycle, your receiver may have a fault. See your authorized dealer for service.
INVALID CHNL	Channel no longer available.	This previously available channel is no longer available. Tune to another channel. If the channel was one of your presets, you may choose another channel for that preset button.
UNSUBSCRIBED	Subscription not available for this channel.	Contact SIRIUS® at 1-888-539-7474 to subscribe to the channel or tune to another channel.

## Entertainment Systems

Radio Display	Condition	Action Required
NO TEXT	Artist information not available.	Artist information not available at this time on this channel. The system is working properly.
NO TEXT	Song title information not available.	Song title information not available at this time on this channel. The system is working properly.
NO TEXT	Category information not available.	Category information not available at this time on this channel. The system is working properly.
NO SIGNAL	Loss of signal from the SIRIUS® satellite or SIRIUS® tower to the vehicle antenna.	You are in a location that is blocking the SIRIUS® signal (i.e., tunnel, under an overpass, dense foliage, etc). The system is working properly. When you move into an open area, the signal should return.
UPDATING	Update of channel programming in progress.	No action required. The process may take up to three minutes.
CALL SIRIUS® 1-888-539-7474	Satellite service has been deactivated by SIRIUS® satellite radio.	Call SIRIUS® at 1-888-539-7474 to re-activate or resolve subscription issues.

## Entertainment Systems

### **NAVIGATION SYSTEM (IF EQUIPPED)**

Your vehicle may be equipped with a navigation system. Refer to the *Navigation System* supplement for further information.

### **SYNC® (IF EQUIPPED)**

Your vehicle may be equipped with SYNC®, a hands-free communications and entertainment system with special phone and media features. For more information, please refer to the *SYNC®* supplement or to the *SYNC®* section in the *Navigation System* supplement (if equipped).

## Climate Controls

### MANUAL HEATING AND AIR CONDITIONING SYSTEM (IF EQUIPPED)

1. **Temperature selection:**

Controls the temperature of the airflow in the vehicle.

2. **Air flow selections:** Controls the direction of the airflow in the vehicle. See the following for a brief description on each control.

**MAX A/C:** Distributes recirculated air through the instrument panel vents to cool the vehicle. This re-cooling of the interior air is more economical and efficient. Recirculated air may also help reduce undesirable odors from entering the vehicle.

 : Distributes air through the instrument panel vents.

 : Distributes air through the instrument panel vents and the floor vents.

**O (OFF):** Outside air is shut out and the climate system is turned off.

 : Distributes air through the floor vents. You may notice a small amount of air flowing from the defroster vents and demister vents.

 : Distributes air through the windshield defroster vents, demister vents and floor vents.



 : Distributes outside air through the windshield defroster vents and demister vents. Can be used to clear thin ice or fog from the windshield.

3.  **Recirculated air:** Press to activate/deactivate air recirculation in the vehicle cabin. Recirculated air may reduce the amount of time to cool down the interior of the vehicle and may also help reduce undesired odors from reaching the interior of the vehicle. Recirculation engages automatically with selection of MAX A/C or can be engaged manually in any other airflow selection except defrost. Recirculation may turn off automatically in all airflow selections except MAX A/C.

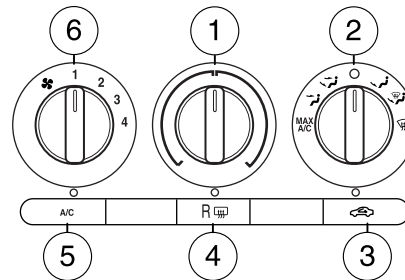
4.  **Rear defroster:** Press to activate/deactivate the rear window defroster. Refer to *Rear window defroster* later in this chapter for more information.



## Climate Controls

5. **A/C:** Press to activate/deactivate air conditioning. Use with recirculated air to improve cooling performance and efficiency. Engages automatically in MAX A/C,  (defrost) and  (floor/defrost).

6. **Fan speed adjustment:** Controls the volume of air circulated in the vehicle.

### Manual heating and air conditioning system with rear passenger compartment climate control (if equipped)

1. **Air flow selections:** Controls the direction of the airflow in the vehicle. See the following for a brief description on each control.

**MAX A/C:** Distributes recirculated air through the instrument panel vents to cool the vehicle. This re-cooling of the interior air is more economical and efficient. Recirculated air may also help reduce undesirable odors from entering the vehicle.

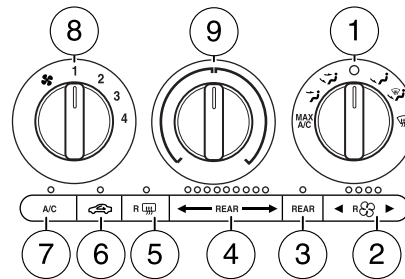



 : Distributes air through the instrument panel vents.

 : Distributes air through the instrument panel vents and the floor vents.

**O (OFF):** Outside air is shut out and the climate system is turned off.

 : Distributes air through the floor vents. You may notice a small amount of air flowing from the defroster vents and demister vents







 : Distributes air through the windshield defroster vents, demister vents and floor vents.

 : Distributes outside air through the windshield defroster vents and demister vents. Can be used to clear thin ice or fog from the windshield.

**Auxiliary climate control operation:** Turn the front air flow control (1) to any position except O (OFF).

2. **R  Rear fan speed control:** Press to enable the auxiliary system or to adjust the rear fan speed from the front control. Press to increase or decrease the fan speed.

## Climate Controls

3. **REAR:** Press to enable the control located in the rear of the floor console (if equipped), or to activate the auxiliary A/C system per the settings on the front control. Press again to turn the auxiliary system off.
4. **◀ REAR ▶ Rear temperature control:** Press to enable the auxiliary system and to set the desired rear cabin airflow temperature with the front control. The rear cabin airflow temperature will match the driver airflow temperature setting when only the center rear temperature light (◀ REAR ▶) is illuminated. The rear cabin airflow temperature will be warmer or cooler than the driver airflow temperature setting when more than one rear temperature light (◀ REAR ▶) is illuminated.
5.  **Rear defroster:** Press to activate/deactivate rear window defroster. Refer to *Rear window defroster* later in this chapter for more information.
6.  **Recirculated air:** Press to activate/deactivate air recirculation in the vehicle cabin. Recirculated air may reduce the amount of time to cool down the interior of the vehicle and may also help reduce undesired odors from reaching the interior of the vehicle. Recirculation engages automatically with selection of MAX A/C or can be engaged manually in any other airflow selection except . Recirculation may turn off automatically in all airflow selections except MAX A/C.
7. **A/C:** Press to activate/deactivate air conditioning. Use with  recirculated air to improve cooling performance and efficiency. Engages automatically in MAX A/C,  (defrost) and  (floor/defrost).
8. **Fan speed adjustment:** Controls the volume of air circulated in the vehicle.
9. **Temperature selection:** Controls the temperature of the airflow to the driver in the front of the vehicle.

## Climate Controls

### Operating tips

- To reduce fog build-up on the windshield during humid weather, place the air flow selector in the  position.
- To reduce humidity build-up inside the vehicle: do not drive with the air flow selector in the O (off) or (in cold weather) MAX A/C position.
- Under normal weather conditions, do not leave the air flow selector in MAX A/C or O (off) when the vehicle is parked. This allows the vehicle to “breathe” using the outside air inlet vents.
- To improve the A/C cool down, drive with the windows slightly open for 2-3 minutes after start up or until the vehicle has been “aired out”.
- During extreme high ambient temperatures when idling stationary for extended periods of time in gear, it is recommended to run the A/C in the MAX A/C position, turn off the rear A/C unit, reduce blower fan speed from the highest setting and put the vehicle’s transmission into the P (Park) position to continue to receive cool air from your A/C system.
- Do not put objects under the front seats that will interfere with the airflow to the back seats.
- Remove any snow, ice or leaves from the air intake area at the base of the windshield.
- A small amount of air may be felt from the floor vent regardless of the air distribution setting that is selected.

To aid in side window defogging/demisting in cold weather:

1. Select .
2. Select A/C.
3. Adjust the temperature control to maintain comfort.
4. Set the fan speed to the highest setting.
5. Direct the outer instrument panel vents towards the side windows.

To increase airflow to the outer instrument panel vents, close the vents located in the middle of the instrument panel.

## Climate Controls



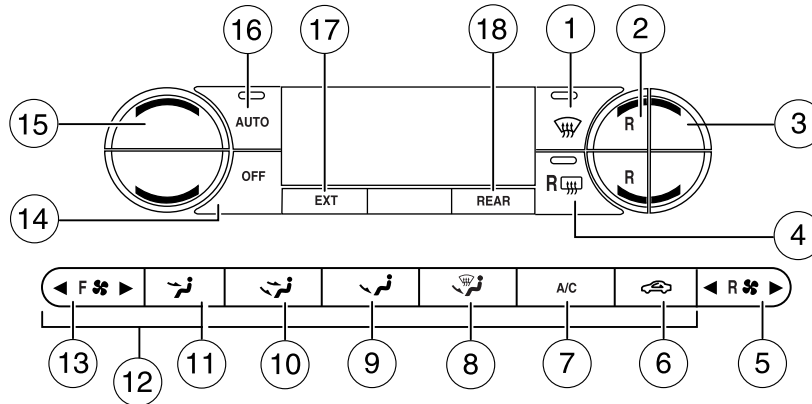







### DUAL ZONE AUTOMATIC TEMPERATURE CONTROL WITH REAR PASSENGER COMPARTMENT CLIMATE CONTROL (IF EQUIPPED)



1. **Defrost:** Distributes outside air through the windshield defroster vents and demister vents. Can be used to clear thin ice or fog from the windshield.
2. **Rear temperature control:** Press to enable the auxiliary system and set the desired rear cabin airflow temperature with the front control. The rear cabin airflow temperature will match the driver airflow temperature setting when only the center rear temperature bar is illuminated. The rear cabin airflow temperature will be warmer or cooler than the driver airflow temperature setting when more than one rear temperature bar is illuminated. When the rear temperature button is pressed, the display will show only the rear cabin settings. After the rear setting changes are completed on the front control, the display will automatically show all climate settings.
3. **Passenger temperature control:** Press to increase/decrease the temperature for the passenger in the front of the vehicle.
4. **Rear defroster:** Press to activate/deactivate the rear window defroster. Refer to *Rear window defroster* later in this chapter for more information.



## Climate Controls

5. **R**  **Rear fan speed control:** Press to enable the auxiliary system or to adjust the rear fan speed from the front control. Press to manually increase or decrease the fan speed. When the rear fan button is pressed, the display will show only the rear cabin settings. After the rear setting changes are completed on the front control, the display will automatically show all climate settings.
6.  **Recirculated air:** Press to activate/deactivate air recirculation in the vehicle cabin. Recirculated air may reduce the amount of time to cool down the interior of the vehicle and may also help reduce undesired odors from reaching the interior of the vehicle. Recirculated air can be engaged manually in any airflow selection except . Recirculated air may turn off automatically in all airflow selections.
7. **A/C:** Press to activate/deactivate air conditioning. Use with  recirculated air to improve cooling performance and efficiency. Engages automatically in AUTO,  (defrost), and  (floor/defrost).
8.  : Distributes air through the windshield defroster vents, demister vents and floor vents.
9.  : Distributes air through the floor vents.
10.  : Distributes air through the instrument panel vents and the floor vents.
11.  : Distributes air through the instrument panel vents.
12. **Manual override controls:** Allows you to manually select where airflow is distributed. To return to full automatic control, press AUTO.
13. **F**  **Front fan speed control:** Press to manually increase or decrease the fan speed. To return to full automatic control, press AUTO.
14. **OFF:** Outside air is shut out and the climate system is turned off.
15. **Driver temperature control:** Press to increase or decrease the temperature on the driver side of the cabin. Sets the passenger side temperature also when DUAL is disengaged. **Note:** The recommended vehicle cabin setting is between 72°F (22°C) and 75°F (24°C).
  - **Dual temperature control:** Press and hold AUTO to engage/disengage separate passenger side temperature control.
16. **AUTO:** Press to engage full automatic operation, and select the desired temperature using the temperature control. The system will automatically determine fan speed, airflow location, A/C on or off, and outside or recirculated air, to heat or cool the vehicle to reach the desired temperature.

## Climate Controls

17. **EXT:** Press to display the outside temperature. Press again to display the cabin temperature settings. **Note:** Exterior readings are more accurate when the vehicle is moving.

18. **REAR:** Press to enable the control located in the rear of the floor console. Press again to turn the auxiliary system off. When the REAR button is pressed, the display will show only the rear cabin settings. After the rear setting changes are completed on the front control, the display will automatically show all climate settings.

### Dual automatic temperature control with heated and cooled seats and rear passenger compartment climate control (if equipped)

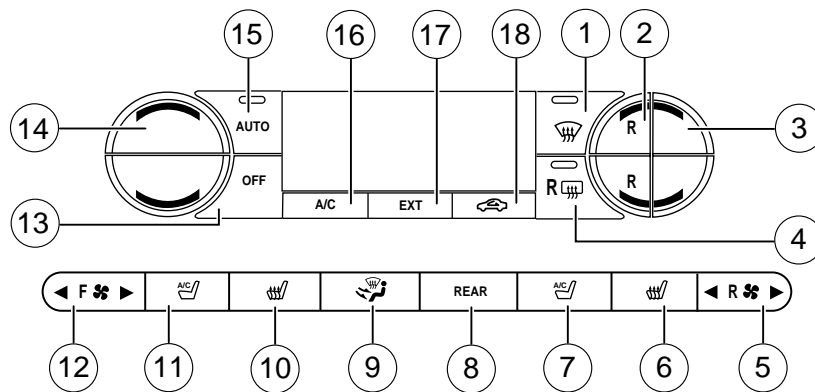













1. **Defrost:** Distributes outside air through the windshield defroster vents and demister vents. Can be used to clear thin ice or fog from the windshield.





2. **Rear temperature control:** Press to enable the auxiliary system and set the desired rear cabin airflow temperature with the front control. The rear cabin airflow temperature will match the driver airflow temperature setting when only the center rear temperature bar is illuminated. The rear cabin airflow temperature will be warmer or cooler than the driver airflow temperature setting when more than one rear temperature bar is illuminated. When the rear temperature button is pressed, the display will show only the rear cabin settings. After the rear setting changes are completed on the front control, the display will automatically show all climate settings.

3. **Passenger temperature control:** Press to increase/decrease the temperature for the passenger in the front of the vehicle.



## Climate Controls

4.  **Rear defroster:** Press to activate/deactivate the rear window defroster. Refer to *Rear window defroster* later in this chapter for more information.
5. R  **Rear fan speed control:** Press to enable the auxiliary system or to adjust the rear fan speed from the front control. Press to manually increase or decrease the fan speed. When the rear fan button is pressed, the display will show only the rear cabin settings. After the rear setting changes are completed on the front control, the display will automatically show all climate settings.
6.  **Passenger heated seat control (if equipped):** Press to activate/deactivate the passenger heated seat. See *Climate controlled seats* in the *Seating and Safety Restraints* chapter.
7.  **Passenger cooled seat control (if equipped):** Press to activate/deactivate the passenger cooled seat. See *Climate controlled seats* in the *Seating and Safety Restraints* chapter.
8. **REAR:** Press to enable the control located in the rear floor console (if equipped). Press again to turn the auxiliary system off. When the REAR button is pressed, the display will show only the rear cabin settings. After the rear setting changes are completed on the front control, the display will automatically show all climate settings.
9.  **Airflow direction control:** Press to toggle through the air distribution modes listed below. The selected mode will be shown in the display.
  -  : Distributes air through the instrument panel vents.
  -  : Distributes air through the instrument panel and the floor vents.
  -  : Distributes air through the floor vents.
  -  : Distributes air through the windshield defroster vents, demister vents and the floor vents.
10.  **Driver heated seat control (if equipped):** Press to activate/deactivate the driver heated seat. See *Climate controlled seats* in the *Seating and Safety Restraints* chapter.
11.  **Driver cooled seat control (if equipped):** Press to activate/deactivate the driver cooled seat. See *Climate controlled seats* in the *Seating and Safety Restraints* chapter.
12. F  **Front fan speed control:** Press to manually increase or decrease the fan speed. To return to full automatic control, press AUTO.

## Climate Controls

13. **OFF:** Outside air is shut out and the climate system is turned off.
14. **Driver temperature control:** Press to increase or decrease the temperature on the driver side of the cabin. Sets the passenger side temperature also when DUAL is disengaged. **Note:** The recommended vehicle cabin setting is between 72°F (22°C) and 75°F (24°C).
15. **AUTO:** Press to engage full automatic operation, and select the desired temperature using the temperature control. The system will automatically determine fan speed, airflow location, A/C on or off, and outside or recirculated air, to heat or cool the vehicle to reach the desired temperature.
16. **A/C:** Press to activate/deactivate air conditioning. Use with  recirculated air to improve cooling performance and efficiency. Engages automatically in AUTO,  (defrost), and  (floor/defrost).
17. **EXT:** Press to display the outside temperature. Press again to display cabin temperature settings. **Note:** Exterior readings are more accurate when the vehicle is moving.
18.  **Recirculated air:** Press to activate/deactivate air recirculation in the vehicle cabin. Recirculated air may reduce the amount of time to cool down the interior of the vehicle and may also help reduce undesired odors from reaching the interior of the vehicle. Recirculated air can be engaged manually in any airflow selection except . Recirculated air may turn off automatically in all airflow selections.

### Operating tips



- To reduce fog build-up on the windshield during humid weather, place the air flow selector in the  position.
- To reduce humidity build-up inside the vehicle: do not drive with the system off or with recirculated air  engaged.
- Under normal weather conditions, do not leave the air flow selector in A/C and recirculated air  or with the system off when the vehicle is parked. This allows the vehicle to “breathe” using the outside air inlet vents.
- Do not put objects under the front seats that will interfere with the airflow to the back seats.
- Remove any snow, ice or leaves from the air intake area at the base of the windshield.
- To improve the A/C cool down, drive with the windows slightly open for 2-3 minutes after start up or until the vehicle has been “aired out.”

## Climate Controls

- A small amount of air may be felt from the floor vent regardless of the air distribution setting that is selected.

During extreme high ambient temperatures when idling stationary for extended periods of time in gear, it is recommended to run the A/C with recirculation mode.  selected, turn off the rear A/C unit, reduce blower fan speed from the highest setting and put the vehicle's transmission into the P (Park) position to continue to receive cool air from your A/C system.

### For maximum cooling performance, (MAX A/C):

- In AUTO: Press AUTO control and set to desired temperature.
- In manual override: Press the  (panel), A/C, and recirculated air , set the temperature to 60°F (16°C) and the fan to the highest blower setting.

### To aid in side window defogging/demisting in cold weather:

1. Select .
2. Select A/C.
3. Adjust the temperature control to maintain comfort.
4. Set the fan speed to the highest setting.
5. Direct the outer instrument panel vents towards the side windows.

To increase airflow to the outer instrument panel vents, close the vents located in the middle of the instrument panel.

### AUXILIARY CLIMATE CONTROL

1. **Fan speed:** Turn to select the desired fan speed.

2. **Temperature/mode selection:**

The distribution of air from the overhead and floor registers is based on the temperature selected. Turn to select for comfort.

To use the rear climate controls, ensure that REAR is pressed on the main climate control face.

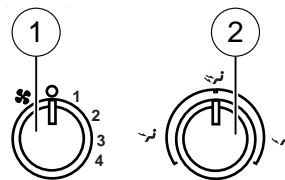

## Climate Controls

### REAR WINDOW DEFROSTER

The rear defroster control is located on the climate control panel and works to clear the rear window of fog and thin ice.

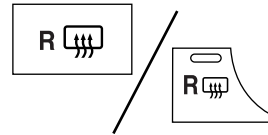

The engine must be running to operate the rear window defroster.

Press the control to turn the rear window defroster on. An indicator light on the button will illuminate when active. The rear window defroster turns off automatically after 15 minutes or when the ignition is turned off. To manually turn off the rear window defroster at any time, press the control again.

**Do not use razor blades or other sharp objects to clean the inside of the rear window or to remove decals from the inside of the rear window. This may cause damage to the heated grid lines and will not be covered by your warranty.**

## Lights

### HEADLAMP CONTROL

Rotate the headlamp control to the first position  to turn on the parking lamps.

Rotate to the second position  to turn on the headlamps.

Rotate back to  to turn the headlamps off.

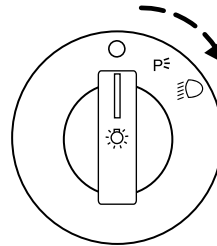

### Autolamp control



The autolamp system provides light sensitive automatic on/off control of the exterior lights normally controlled by the headlamp control.

The autolamp system also keeps the lights on for approximately 20 seconds or, if equipped with a message center, you can select a delay from 0–180 seconds after the ignition switch is turned off. See *Message center* in the *Instrument Cluster* chapter.

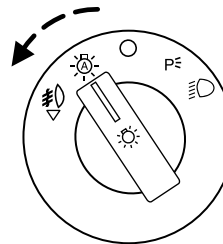
- To turn autolamps on, rotate the control counterclockwise.
- To turn autolamps off, rotate the control to the off position.



### Fog lamp control (if equipped)

The headlamp control also operates the fog lamps. The fog lamps can be turned on when the headlamp control is in the ,  or  positions and the high beams are not turned on.

Pull the headlamp control towards you to turn the fog lamps on. The fog lamp indicator light will illuminate.

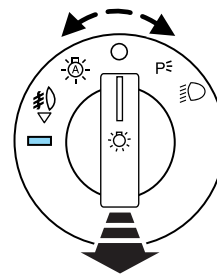

## Lights

### High beams

Push the lever toward the instrument panel to activate. Pull the lever toward you to deactivate.

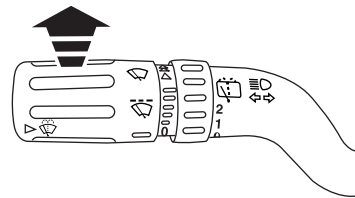

### Flash-to-pass

Pull toward you slightly to activate and release to deactivate.

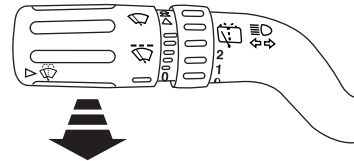

### Daytime running lamps (DRL) (if equipped)

Turns the headlamps on at reduced intensity output. To activate:

- the ignition must be in the on position and
- the headlamp control must be in the off, autolamps or parking lamps position.



**WARNING:** Always remember to turn on your headlamps at dusk or during inclement weather. The Daytime Running Lamp (DRL) system does not activate the tail lamps and generally may not provide adequate lighting during these conditions. Failure to activate your headlamps under these conditions may result in a collision.



## Lights

### PANEL DIMMER CONTROL

Use to adjust the brightness of the instrument panel and all applicable switches in the vehicle during headlamp and parking lamp operation.

Move the control to the full upright position, past detent, to turn on the interior lamps.

Move the control to the full down position, past detent, to prevent the interior lights from illuminating when the doors are opened. When the control is in the full down position, it acts as a dome lamp defeat/override.

**Note:** If the battery is disconnected, discharged, or a new battery is installed, the dimmer switch requires re-calibration. Rotate the dimmer switch from the full dim position to the full dome/on position to reset. This will ensure that your displays are visible under all lighting conditions.

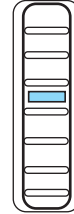

### AIMING THE HEADLAMPS

The headlamps on your vehicle are properly aimed at the assembly plant. If your vehicle has been in an accident the alignment of your headlamps should be checked by your authorized dealer.

#### Vertical aim adjustment

Before aim adjustment, disable the air suspension system. Refer to *Message center* in the *Driver Controls* chapter.

1. Park the vehicle directly in front of a wall or screen on a level surface, approximately 25 feet (7.6 meters) away.

- (1) 8 feet (2.4 meters)
- (2) Center height of lamp to ground
- (3) 25 feet (7.6 meters)
- (4) Horizontal reference line

2. Measure the height from the center of your headlamp (indicated by a 3.0 mm circle on the lens) to the ground and mark an 8 foot (2.4 meter) horizontal reference line on the vertical wall or screen at this height (a piece of masking tape works well).

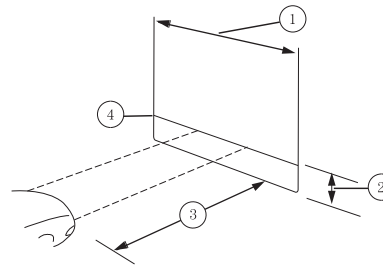

## Lights

3. Turn on the low beam headlamps to illuminate the wall or screen and open the hood. Cover one of the headlamps so no light from that lamp hits the wall.

4. On the wall or screen you will observe a light pattern with a distinct horizontal edge towards the right. If this edge is not at the horizontal reference line, the beam will need to be adjusted so the edge is at the same height as the horizontal reference line.

5. Locate the vertical adjuster on each headlamp, then use a Phillips #2 screwdriver to turn the adjuster either counterclockwise (to adjust down) or clockwise (to adjust up) aligning the upper edge of the light pattern up to the horizontal line.

6. Repeat Steps 3–5 for the other headlamp.

7. Close the hood and turn off the lamps.

HORIZONTAL AIM IS NOT REQUIRED FOR THIS VEHICLE AND IS NON-ADJUSTABLE.

### TURN SIGNAL CONTROL

- Push down to activate the left turn signal.
- Push up to activate the right turn signal.

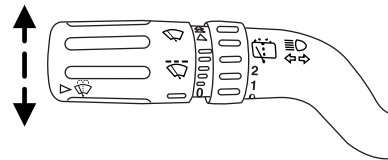
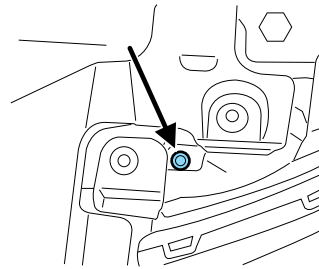
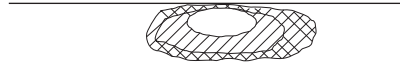

### INTERIOR LAMPS

#### Front row map lamps (if equipped)

To turn on the map lamps, press the outer edge of the clear lens. The front row map lamp lights when:

- any door is opened.
- the instrument panel dimmer switch is rotated until the courtesy lamps come on.
- the remote entry controls are pressed and the ignition is off.

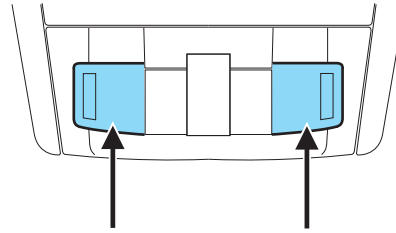

#### Front row map/dome lamp (if equipped)

The dome lamp lights when:

- any door is opened,
- the instrument panel dimmer switch is rotated up until the courtesy lamps come on, and
- any of the remote entry controls are pressed and the ignition is off.

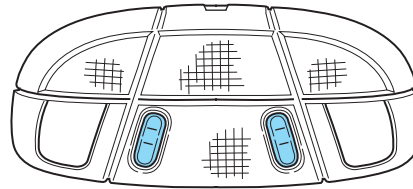

The map lamps are activated by pressing the controls on either side of the lens.

#### Second row map lamps (if equipped)

The second row map lamps are located in the headliner above the second row seats.

The second row map lamp lights when:

- any door is opened,
- the instrument panel dimmer switch is rotated up until the courtesy lamps come on, and
- any of the remote entry controls are pressed and the ignition is off.

Press the controls to activate the lamps.

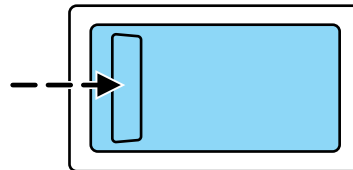

## Lights

### Rear cargo lamp

The dome lamp lights when:

- any door is opened, and the switch is in the middle position.
- the instrument panel dimmer switch is rotated until the courtesy lamps come on.
- any of the remote entry controls are pressed and ignition is off (and switch is in the middle position).

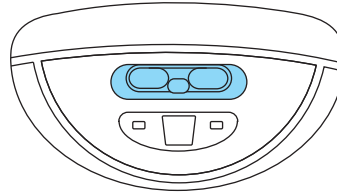

With the ignition key in the accessory or on position, the rear dome lamp can be turned on or off by sliding the control.

### Battery saver

The battery saver will shut off the exterior lamps and interior lamps, except the hazard warning lamps if activated, 10 minutes after the ignition control has been turned off. The system will not turn off the parking lamps if they are on.

## BULB REPLACEMENT

### Lamp assembly condensation

Exterior lamps are vented to accommodate normal changes in pressure. Condensation can be a natural by-product of this design. When moist air enters the lamp assembly through the vents, there is a possibility that condensation can occur when the temperature is cold. When normal condensation occurs, a thin film of mist can form on the interior of the lens. The thin mist eventually clears and exits through the vents during normal operation. Clearing time may take as long as 48 hours under dry weather conditions.

Examples of acceptable condensation are:

- Presence of thin mist (no streaks, drip marks or droplets)
- Fine mist covers less than 50% of the lens

Examples of unacceptable moisture (usually caused by a lamp water leak) are:

- Water puddle inside the lamp
- Large water droplets, drip marks or streaks present on the interior of the lens

Take your vehicle to a dealer for service if any of the above conditions of unacceptable moisture are present.

## Lights

### Using the right bulbs

Replacement bulbs are specified in the chart below. Headlamp bulbs must be marked with an authorized "D.O.T." for North America to ensure lamp performance, light brightness and pattern and safe visibility. The correct bulbs will not damage the lamp assembly or void the lamp assembly warranty and will provide quality bulb burn time.

Function	Number of bulbs	Trade number
Headlamps (low and high-beam)	2	H13/9008
Front sidemarker	2	194
Front park/turn lamps	2	3157 A
Fog lamps	2	9145
Front row map lamps	2	W5W
Front row map/dome lamps	3	578
Rear cargo lamp	1	578
2nd row reading lamp	2	W5W
Turn/tail/brake/sidemarker lamps	2	3157K or 4157K
Backup lamp	2	921
Approach/mirror turn signal lamps (if equipped)	2	906
Mirror approach lamps – non turn signal (if equipped)	2	*See your dealer
License lamp	2	168
Visor vanity lamp - Slide on rail system (SOR)	2	A6224PF
High-mount brake lamp	5	W5W
All replacement bulbs are clear in color except where noted.		
To replace all instrument panel lights - see your authorized dealer		
* To obtain replacement approach lamp assembly bulbs, see your authorized dealer and reference Ford part no. 2L1Z-13B374-BB for the passenger side mirror and 2L1Z-13B375-BB for the driver side mirror.		

## Lights

### Replacing interior bulbs

Check the operation of all bulbs frequently.

### Replacing exterior bulbs

Check the operation of all the bulbs frequently.

#### **Replacing headlamp bulbs**

1. Make sure that the headlamp control is in the off position.
2. Open the hood.
3. At the back of the headlamp, remove the two headlamp assembly retainer bolts.
4. Slide headlamp assembly forward and off the retaining tab to expose the back of the bulb and electrical connector.

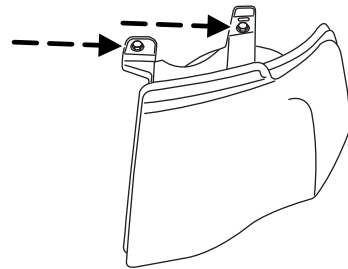

5. Disconnect the electrical connector.
6. Remove the bulb by turning it counterclockwise and then pulling it straight out.

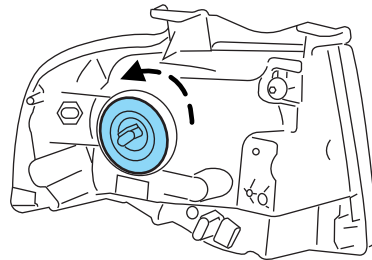

**⚠ WARNING:** Handle a halogen headlamp bulb carefully and keep out of children's reach. Grasp the bulb only by its plastic base and do not touch the glass. The oil from your hand could cause the bulb to break the next time the headlamps are operated.

## Lights

7. Insert the glass end of the new bulb into the headlamp assembly. When the grooves in the plastic base are aligned, turn the new bulb clockwise to install.
8. Connect the electrical connector.
9. Install the headlamp assembly and secure with two retainer bolts.

### **Replacing front parking lamp/turn/sidemarkers signal bulbs**

1. Make sure that the headlamp control is in the off position.
2. Open the hood.
3. At the back of the headlamp, remove the two headlamp assembly retainer bolts.
4. Slide headlamp assembly forward and off the retaining tab to expose the back of the headlamp assembly.

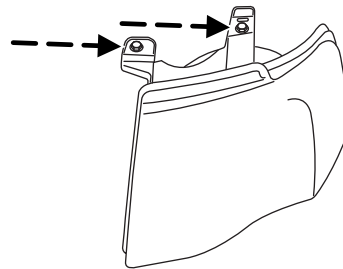

5. Rotate the bulb socket counterclockwise and remove from the lamp assembly.
6. Carefully pull the bulb out of the socket and push in the new bulb.
7. Install the bulb socket into the lamp assembly and rotate clockwise.
8. Install the headlamp assembly and secure with two retainer bolts.

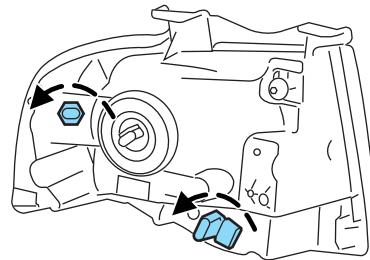

## Lights

### **Replacing tail/stop/turn/sidemarkers/backup lamp bulbs**

The tail/stop/turn/sidemarkers/backup lamp bulbs are located in the same portion of the tail lamp assembly, one just below the other. Follow the same steps to replace either bulb:

1. Make sure the headlamp switch is in the off position and then open the liftgate to expose the lamp assembly screws.

2. Remove the two torx screws from the lamp assembly.

3. Carefully remove the lamp assembly away from the vehicle by pulling the assembly straight out to expose the bulb socket. **DO NOT TIP THE LAMP ASSEMBLY SIDEWAYS.**

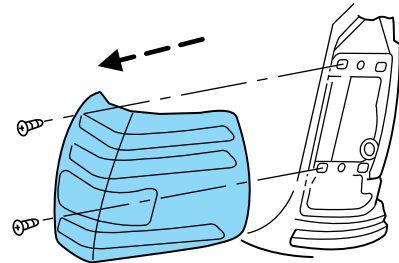

4. Rotate the bulb socket counterclockwise and remove from lamp assembly.

5. Pull bulb straight out of socket and snap in the new bulb.

6. Install the bulb socket into the lamp assembly and rotate clockwise.

7. Carefully install the tail lamp assembly on the vehicle by securing the lamp assembly with two torx screws.

### **Replacing the high-mount brake lamp**

To change the high-mount brake lamp bulbs:

1. Remove the two screws holding the lamp assembly in place.

2. Pull the lamp assembly straight out.

3. Disconnect the wire harness.

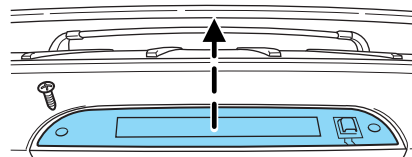



## Lights

4. Press the four tabs that hold the light assembly on, one at a time, and pull the black bulb carrier away from the lamp.
5. Pull the old bulb out and replace with the new bulb.
6. Snap the black bulb carrier into the lamp assembly.
7. Connect the wire harness.
8. Install the lamp assembly with two screws.

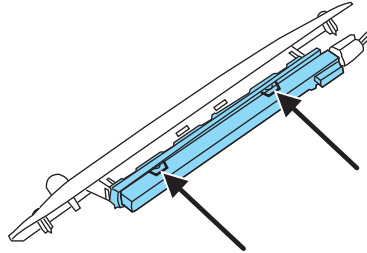

### **Replacing fog lamp bulbs**

1. From underneath the vehicle, rotate the harness/bulb assembly counterclockwise, to remove from the fog lamp assembly.
2. Carefully disconnect the bulb from the harness assembly via the two snap clips.

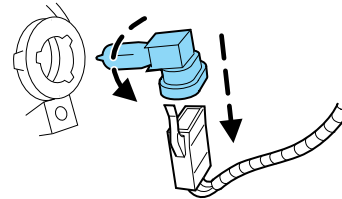

Install the new bulb in reverse order.

### **Replacing license plate lamp bulb**

The license plate bulbs are located in the license plate housing assembly on the liftgate. To change the license plate bulbs:

1. Make sure the headlamp switch is in the off position.
2. Remove the license lamp screw from the assembly.
3. Pull the lamp down and twist the bulb socket counterclockwise. Remove the bulb socket from the lamp.
4. Pull out the old bulb and push in the new bulb.
5. Install the bulb socket in the lamp assembly by turning it clockwise.
6. Install the lamp assembly and secure it with the retaining screw.

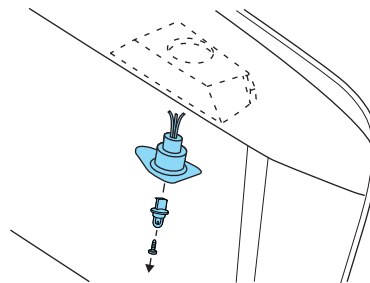

### **Replacing approach lamp/mirror turn signal bulbs (if equipped)**

For bulb replacement, see your authorized dealer.

## Driver Controls

### MULTI-FUNCTION LEVER

**Windshield wiper:** Rotate the end of the control away from you to increase the speed of the wipers; rotate towards you to decrease the speed of the wipers.

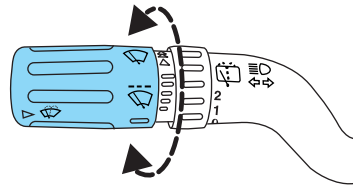

**Speed dependent wipers:** When the wiper control is on, the speed of the wipers will automatically adjust with the vehicle speed. The faster your vehicle is travelling the faster the wipers will go.

**Rain sensing wipers (if equipped):** The rain sensing wipers will automatically activate when moisture is present on the windshield and the multi-function switch is set to one of five auto/interval moisture sensitivity settings. Rotate the end of the control toward the windshield to increase the sensitivity. The speed of the rain sensitive wipers will vary based on the amount of moisture detected on the windshield and the auto/interval setting. There are no interval (intermittent wipe) settings on vehicles with rain sensing wipers. The wipers will continue to wipe as long as the presence of moisture is detected on the windshield. More or less wiping may occur depending on humidity, mist or light rain, or road spray.

Keep the outside of the windshield clean, especially the area around the rear view mirror where the sensor is located or rain sensor performance may be affected.

**Note:** During winter driving conditions with ice, snow or a salty road mist, inconsistent or unexpected wiping or smearing may occur. In these conditions, you can lower the sensitivity to reduce the amount of smearing or override the feature by selecting low- or high-speed wiping or turning the wiper system off.

**Note:** The wipers must be turned off before entering a car wash.

**Windshield washer:** Press the end of the stalk:

- briefly: causes a single swipe of the wipers without washer fluid.
- a quick press and hold: the wipers will swipe three times with washer fluid.
- a long press and hold: the wipers and washer fluid will be activated for up to ten seconds.

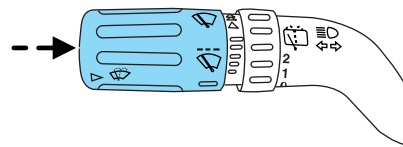

## Driver Controls

**Courtesy wipe feature:** One extra wipe will occur a few seconds after washing the front window to clear any excess washer fluid remaining on the windshield.

**Note:** Do not operate the washer when the washer reservoir is empty. This may cause the washer pump to overheat. Check the washer fluid level frequently. Do not operate the wipers when the windshield is dry. This may scratch the glass, damage the wiper blades and cause the wiper motor to burn out. Before operating the wiper on a dry windshield, always use the windshield washer. In freezing weather, be sure the wiper blades are not frozen to the windshield before operating the wipers.

### Windshield wiper rainlamp feature (if equipped with autolamp)

When the windshield wipers are turned on during daylight, and the headlamp control is in the autolamp position, the exterior lamps will turn on after a brief delay and will remain on until the wipers are turned off.

### Rear window wiper/washer controls

For rear wiper operation, rotate the rear window wiper and washer control to the desired position. Select:

2 — Normal speed operation of rear wiper.

1 — Intermittent operation of rear wiper.

0 (off) — Rear wiper and washer off.

For rear wash cycle, rotate (and hold as desired) the rear wiper/washer control to either  position.

From either position, the control will automatically return to the 2 or 0 (off) position.

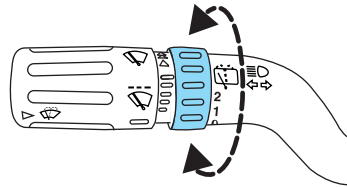

## Driver Controls

### TILT STEERING WHEEL

1. Pull and hold the steering wheel release control toward you.
2. Move the steering up or down until you find the desired location.
3. Release the steering wheel release control. This will lock the steering wheel in position.

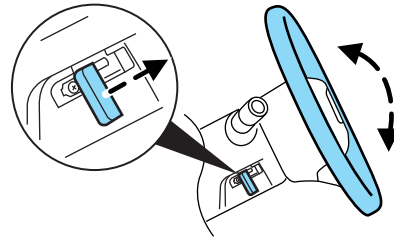

**WARNING:** Never adjust the steering column when the vehicle is moving.

### ILLUMINATED VISOR MIRROR (IF EQUIPPED)

Lift the mirror cover to turn on the visor mirror lamp.

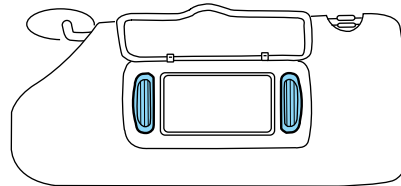

### Slide-on-rod feature (if equipped)

Rotate the visor towards the side window and extend it rearward for additional sunlight coverage.

**Note:** To stow the visor back into the headliner, visor must be retracted before moving it back towards the windshield.

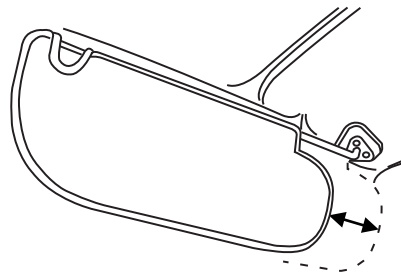

## Driver Controls

### OVERHEAD CONSOLE

The appearance of your vehicle's overhead console will vary according to your option package.

#### Forward storage bin (if equipped)

The storage compartment may be used to store a pair of sunglasses. Press the release area on the rear edge of the bin door to open the storage compartment. The door will open to full open position.

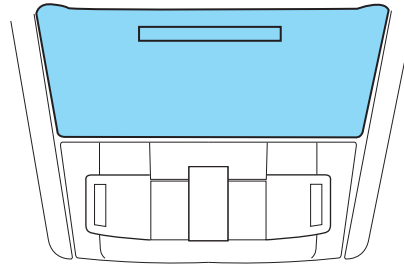

#### Conversation mirror (if equipped)

On double bin overhead consoles, the conversation mirror allows the driver to view the rear seating area.



**WARNING:** Do not use the conversation mirror to view rearward traffic, do not allow rear passengers to distract you from the driving task, and make sure the rear view mirror has a clear view of rearward traffic. Failure to do so could increase the risk of a crash from an unseen vehicle, which may result in serious injury.

Press the release area on the rear edge of the bin door to open the conversation mirror. The door will open to full open position.

The rear view mirror may have to be adjusted to its lower arm position to prevent interference when the conversation mirror is extended down.

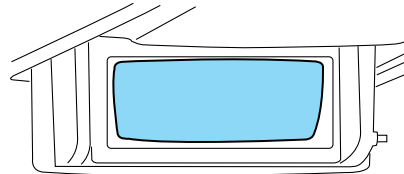

## Driver Controls

### Power quarter rear windows (if equipped)

Press and hold the VENT portion of the control to open the power rear quarter windows.

Pull and hold the VENT control to close the power rear quarter windows.

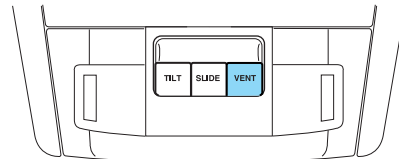

**Note:** Vehicles without a moon roof, will only have the VENT button.



**WARNING:** Do not leave children unattended in the vehicle and do not let children play with the power rear quarter windows. They may seriously injure themselves.



**WARNING:** When closing the power rear quarter windows, you should verify that it is free of obstructions and ensure that children and/or pets are not in the proximity of the window opening.

### CENTER CONSOLE (IF EQUIPPED)

Your vehicle may be equipped with a variety of console features. These include:

1. Cupholders
2. Utility compartment, coin holder slots, tissue box holder, audio input jack and USB port (if equipped)
3. Power point, rear climate controls, rear audio controls (if equipped), rear heated seat controls (if equipped) and 110V AC power point (if equipped)
4. Rear cupholders

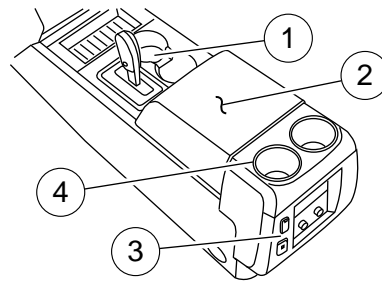

**WARNING:** Use only soft cups in the cupholder. Hard objects can injure you in a collision.

## Driver Controls

### AUXILIARY POWER POINT (12V DC)

**Power outlets are designed for accessory plugs only. Do not insert any other object in the power outlet as this will damage the outlet and blow the fuse. Do not hang any type of accessory or accessory bracket from the plug. Improper use of the power outlet can cause damage not covered by your warranty.**

Auxiliary power points can be found in the following locations:

- On the instrument panel
- On the rear of the center console, accessible from the rear seats
- On the right rear quarter panel, accessible from the liftgate or the third row seat

Do not use the power point for operating the cigarette lighter element (if equipped).

To prevent the fuse from being blown, do not use the power point(s) over the vehicle capacity of 12V DC/180W. If the power point or cigar lighter socket is not working, a fuse may have blown. Refer to *Fuses and relays* in the *Roadside Emergencies* chapter for information on checking and replacing fuses.

To have full capacity usage of your power point, the engine is required to be running to avoid unintentional discharge of the battery. To prevent the battery from being discharged:

- do not use the power point longer than necessary when the engine is not running,
- do not leave battery chargers, video game adapters, computers and other devices plugged in overnight or when the vehicle is parked for extended periods.

Always keep the power point caps closed when not being used.

## Driver Controls

### Power point (110V AC) (if equipped)

The 110V AC power point outlet is used for powering electrical devices that require up to 150W. Exceeding the 150W limit will cause the power point to cut off the power temporarily to provide overload protection.

**Note:** The 110V AC power point is equipped with a safety cap and a safety twist tab. They both provide protection from inserting any object into the power point other than the 110V AC electrical device plug. The safety cap should always be in a closed position whenever the power point outlet is not in use.

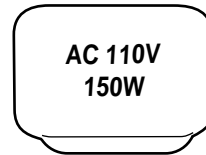

The 110V AC power point is located on the back of the center console.

The power outlet is not designed for the following electric appliances; they may not work properly:

- Cathode ray tube type televisions
- Motor loads, such as vacuum cleaners, electric saws and other electric power tools, compressor-driven refrigerators, etc.
- Measuring devices, which process precise data, such as medical equipment, measuring equipment, etc.
- Other appliances requiring an extremely stable power supply: microcomputer-controlled electric blankets, touch sensor lamps, etc.



**WARNING:** Do not keep electrical devices plugged in the power point whenever the device is not in use. Do not use any extension cord with the 110V AC power point, since it will defeat the safety protection design provided by the cap and twist tab. Doing so may cause the power point to overload due to powering multiple devices that can reach beyond the 150W load limit and could result in fire or serious injury.

The power point can switch to a fault mode when it is overloaded, overheated, or shorted. For overloading and shorting conditions, unplug your device and turn the ignition key off then on. For an overheating condition, let the system cool off, then turn the ignition key off then on.



## Driver Controls

The 110V AC power point can provide power whenever the vehicle ignition is in the on position and the power point green indicator light located in the top left corner is turned on. Refer to the indicator light code below for the power point status.

### Indicator light codes

Green light is on — Power point is ready to supply power

Green light is off — Power point power supply is off. Ignition is not in the on position

Green light is blinking — Power point is in fault mode

### Cupholder/Ashtray (if equipped)

The cupholder/ashtray is located on the instrument panel.

To open cupholder/ashtray, push in on the door and release. The door will spring out 1/4+ inches. Then pull cupholder/ashtray assembly out the remaining distance to utilize. To close, push assembly in completely and release.

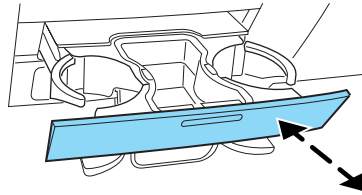

### POWER WINDOWS



**WARNING:** Do not leave children unattended in the vehicle and do not let children play with the power windows. They may seriously injure themselves.



**WARNING:** When closing the power windows, you should verify they are free of obstructions and ensure that children and/or pets are not in the proximity of the window openings.

Press and pull the window switches to open and close windows.

- Press down (to the first detent) and hold the switch to open.
- Pull up (to the first detent) and hold the switch to close.

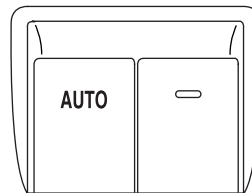

## Driver Controls

**Rear window buffeting:** When one or both of the rear windows are open, the vehicle may demonstrate a wind throb or buffeting noise; this noise can be alleviated by:

- lowering a front window approximately two to three inches or
- opening 3rd row power quarter glass, for vehicles equipped with this option.

### **One-touch up or down (driver's window only)**

This feature allows the driver's window to open or close fully without holding the control down.

To operate one-touch down, press the switch completely down to the second detent and release quickly. The window will open fully. Momentarily press the switch to any position to stop the window operation.

To operate one-touch up, pull the switch completely up to the second detent and release quickly. The window will close fully. Momentarily press the switch to any position to stop the window operation.

### **Bounce-back (driver's window only)**

When an obstacle has been detected in the window opening as the window is moving upward, the window will automatically reverse direction and move down. This is known as "bounce-back". If the ignition is turned off (without accessory delay being active) during bounce-back, the window will move down until the bounce-back position is reached.

### **Security override**

To override a bounce-back condition, within two seconds after the window reaches the bounce-back position, pull and hold the switch up and **the window will travel up with no bounce-back or pinch protection**. If the switch is released before the window is fully closed, the window will stop. For example, this can be used to overcome the resistance of ice on the window or seals.

## Driver Controls

### Window lock

The window lock feature allows only the driver and front passenger to operate the power windows.

To lock out all the window controls (except for the driver and front passenger) press the right side of the control. Press the left side to restore the window controls.

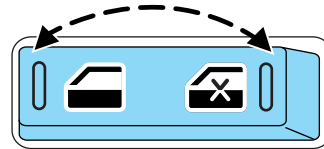

### Accessory delay

With accessory delay, the audio system, power windows and moon roof (if equipped) operate for up to 10 minutes after the ignition is turned off or until either front door is opened.

### INTERIOR MIRROR

The interior rear view mirror has two pivot points on the support arm which lets you adjust the mirror up or down and from side to side.



**WARNING:** Do not adjust the mirror while the vehicle is in motion.

### Automatic dimming interior rear view mirror

The interior rear view mirror has an auto-dimming function (optional on the driver's side exterior mirror). The electronic day/night mirror will change from the normal (high reflective) state to the non-glare (darkened) state when bright lights (glare) reach the interior mirror. When the interior mirror detects bright light from behind the vehicle, the interior rear view mirror and the driver's side exterior mirror (if equipped) will automatically adjust (darken) to minimize glare.

The mirrors will automatically return to the normal state whenever the vehicle is placed in R (Reverse) to ensure a bright clear view when backing up.

**Do not block the sensors on the front and back of the interior rear view mirror since this may impair proper mirror performance.**

**Note:** A rear center passenger and/or raised rear center headrest (if equipped) may also block the light from reaching the sensor.

## Driver Controls

**Do not clean the housing or glass of any mirror with harsh abrasives, fuel or other petroleum-based cleaning products.**

**Note:** If equipped with a rearview camera system, a video image will display in the mirror or the navigation system display (if equipped) when the vehicle is put in R (Reverse). As you shift into any other gear from R (Reverse), the image will remain for a few seconds and then turn off. Refer to *Rearview camera system* in the *Driving* chapter.

### EXTERIOR MIRRORS

#### Power side view mirrors



**WARNING:** Do not adjust the mirror while the vehicle is in motion.

To adjust your mirrors:

1. Rotate the control clockwise to adjust the right mirror and rotate the control counterclockwise to adjust the left mirror.
2. Move the control in the direction you wish to tilt the mirror.
3. Return to the center position to lock mirrors in place.



#### Memory feature (if equipped)

The power side view mirror positions are saved when doing a memory set function and can be recalled along with the vehicle personality features when a memory position is selected through the remote entry transmitter, keyless entry keypad or memory switch on the driver's door. Refer to *Seating* in the *Seating and Safety Restraints* chapter.

#### Automatic dimming feature (if equipped)

The driver's side view mirror has an auto-dimming function. For more information, refer to *Automatic dimming interior rear view mirror* in this chapter.

## Driver Controls

### Fold-away mirrors

Fold the side mirrors in carefully before driving through a narrow space, like an automatic car wash.

### Powerfold mirrors (if equipped)

Rotate the 4-way adjustment switch to the center position. Press the switch down to auto fold in and down again to auto fold back to design position. Powerfold the side mirrors in carefully when driving through a narrow space, like an automatic car wash.

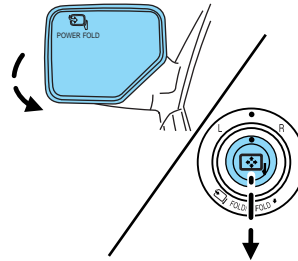

The mirrors may be moved inward/outward manually. If a mirror is moved manually, it will need to be reset. To reset: with the switch in the center position, press the switch down to fold the mirrors in and wait a short period (eight seconds). An audible “click” will be heard indicating re-synchronization. If the click is not heard, use the switch to fold the mirrors out, then in, until the click is heard. After that, the mirrors will operate to their normal positions until they are again moved manually.

**Note:** 10 or more switch activations within one minute, or repeated folding/unfolding of the mirrors while holding the switch rearward during full travel, may cause the system to disable the fold/unfold function to protect motors from overheating. Should this occur, wait approximately three minutes with the vehicle running and up to 10 minutes with the vehicle off, for the system to reset and for function to return to normal.

### Heated outside mirrors

Both mirrors are heated automatically to remove ice, mist and fog when the rear window defrost is activated.

**Do not remove ice from the mirrors with a scraper or attempt to readjust the mirror glass if it is frozen in place. These actions could cause damage to the glass and mirrors.**

**Do not clean the housing or glass of any mirror with harsh abrasives, fuel or other petroleum-based cleaning products.**

## Driver Controls

### Signal indicator mirrors (if equipped)

When the turn signal is activated, the lower portion of the mirror housing will blink.

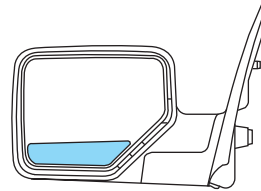

### POWER ADJUSTABLE FOOT PEDALS (IF EQUIPPED)

The accelerator and brake pedal should only be adjusted when the vehicle is stopped and the gearshift lever is in the P (Park) position.

Press and hold the rocker control to adjust accelerator and brake pedal.

- Press the top of the control to adjust the pedals toward you.
- Press the bottom of the control to adjust the pedals away from you.

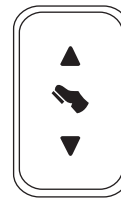

**WARNING:** Never adjust the accelerator and brake pedal with feet on the pedals while the vehicle is moving.

## Driver Controls

### POWER DEPLOYABLE RUNNING BOARDS (IF EQUIPPED)

Deployable running boards (DRB) automatically move when the doors are opened to assist entering and exiting the vehicle.

#### Automatic power deploy:

- The running boards will extend down and out when the doors are opened.

#### Automatic power stow:

- The running boards will return to the stowed position when the doors are closed. There will be a two second delay before the running boards move in to the stowed position.

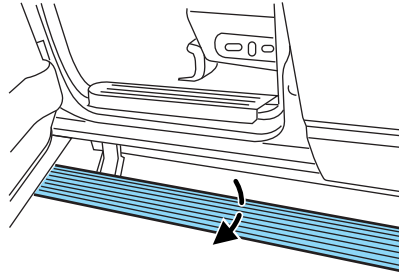

#### Manual power deploy:

To manually operate the running boards, refer to *Message center* in the *Instrument Cluster* chapter.

- This feature can manually set the running boards in the deployed (OUT) position for access to the roof.
- When running boards are manually set in the deployed position, the boards will return to the stowed position and enter automatic mode when the vehicle speed exceeds 5 mph (8 km/h).

#### Enable/disable:

To enable/disable the power running board feature, refer to *Message center* in the *Instrument Cluster* chapter.

- When this feature is disabled (OFF), the running boards will move to the stowed position regardless of the position of the doors.
- When this feature is enabled (AUTO), the running boards will move back to the correct positions based off of the door positions.

#### Bounce-back:

- If an object is in the way of the moving running board, the running board will automatically bounce back in the reverse direction and move to the end of travel.

**Note:** The running boards may operate slower in cooler temperatures. In adverse conditions, debris such as mud, dirt, and salt may become trapped in the running board mechanism, possibly leading to unwanted noise. If this occurs, manually set the running boards to the deployed

## Driver Controls

position and flush the system (in particular the front and rear hinge arms) with a high-pressure car wash wand.

**Note:** Do not use the running boards, front and rear hinge assemblies, running board motors, or the running board under body mounts to lift the vehicle when jacking. Please utilize proper jacking points. Refer to *Changing the tires* in the *Roadside Emergencies* chapter.

 **WARNING:** In extreme climates, excessive ice buildup may occur, causing the running boards not to deploy. Be sure that the running boards have deployed, and have finished moving before attempting to step on them. Note: The running boards will resume normal function once the blockage is cleared.

 **WARNING:** Turn off the running boards before jacking or placing any object under the vehicle. Never place your hand between the extended running board and the vehicle. A moving running board may cause injury.

## SPEED CONTROL (IF EQUIPPED)

With speed control set, you can maintain a set speed without keeping your foot on the accelerator pedal.

 **WARNING:** Do not use the speed control in heavy traffic or on roads that are winding, slippery or unpaved.

### Using speed control

The speed controls are located on the steering wheel. The following buttons work with speed control:

**OFF:** Press to turn speed control off.

**ON:** Press to turn speed control on.

**SET +/-:** Press to set a speed or increase/decrease the set speed.

**RES (Resume):** Press to resume a set speed.

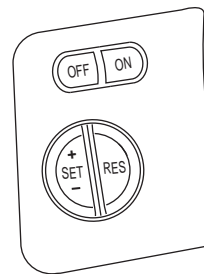



## Driver Controls

### **Setting speed control**

1. Press and release ON.
2. Accelerate to the desired speed.
3. Press and release SET +.
4. Take your foot off the accelerator pedal.
5. The indicator light  on the instrument cluster will turn on.

### **Note:**

- Vehicle speed may vary momentarily when driving up and down a steep hill.
- If the vehicle speed increases above the set speed on a downhill, you may want to apply the brakes to reduce the speed.
- If the vehicle speed decreases more than 10 mph (16 km/h) below your set speed on an uphill, your speed control will disengage.

### **Disengaging speed control**

Press the brake pedal to disengage the speed control. Disengaging the speed control will not erase the previous set speed.

### **Resuming a set speed**

Press and release RES. This will automatically return the vehicle to the previously set speed.

### **Increasing speed while using speed control**

To set a higher speed:

- Press and hold SET + until you get to the desired speed, then release. You can also use SET + to operate the tap-up function. Press and release SET + to increase the vehicle set speed in 1 mph (2 km/h) increments.
- Use the accelerator pedal to get to the desired speed then press and release SET +.

### **Reducing speed while using speed control**

To reduce a set speed:

- Press and hold SET – until you get to the desired speed, then release. You can also use SET – to operate the tap-down function. Press and release SET – to decrease the vehicle set speed in 1 mph (2 km/h) increments.
- Press the brake pedal until the desired vehicle speed is reached, then press SET +.

## Driver Controls

### **Turning off speed control**

To turn off the speed control, press OFF or turn off the ignition.

**Note:** When you turn off the speed control or the ignition, your speed control set speed memory is erased.

### **STEERING WHEEL CONTROLS (IF EQUIPPED)**

#### **Audio control features**

**MEDIA:** Press repeatedly to scroll through available audio modes.

**SEEK:** Press to select the previous/next radio station preset, CD track or satellite radio station preset depending on which media mode you are in.

**+ VOL – (Volume):** Press to increase or decrease the volume.

#### **Navigation system hands free control features (if equipped)**

Press and hold VOICE briefly until the voice icon appears on the Navigation display to use the voice command feature.

Press VOICE to complete a voice command.

For further information on the Navigation system, refer to the *Navigation System* supplement.

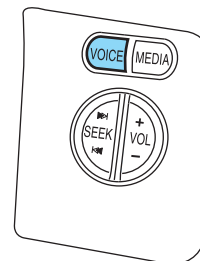
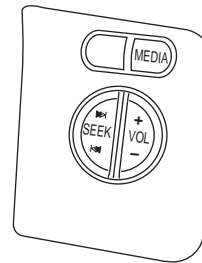



## Driver Controls

### **SYNC® system hands free control feature (if equipped)**

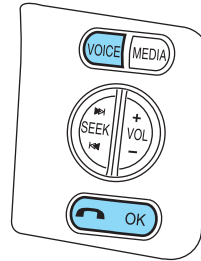
Press VOICE briefly until the voice  icon appears on the display to use the voice command feature. You will hear a tone and LISTENING will appear in the radio display. Press and hold VOICE to exit voice command.



Press  to activate phone mode or answer a phone call. Press and hold  to end call or exit phone mode.



Press  to scroll through various menus and selections. Press OK to confirm your selection.

For further information on the SYNC® system, refer to the SYNC® supplement.

### **Navigation system/SYNC® hands free control features (if equipped)**

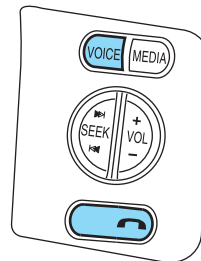
Press VOICE briefly until the voice  icon appears on the Navigation display to use the voice command feature.



Press  to activate phone mode or answer a phone call. Press and hold  to exit phone mode or end call.

For further information on the Navigation system/SYNC® system, refer to the *Navigation System* and SYNC® supplements.

## Driver Controls

### MOON ROOF (IF EQUIPPED)

The moon roof control is located on the overhead console.



**WARNING:** Do not let children play with the moon roof or leave children unattended in the vehicle. They may seriously hurt themselves.

The moon roof is equipped with an automatic, one-touch, express opening and closing feature. To stop motion at any time during the one-touch operation, press the control a second time.

**To open the moon roof:** Press and release the SLIDE control and the moon roof will open automatically to the “comfort” position. Press and release again to fully open. Press the switch again to stop the moon roof.

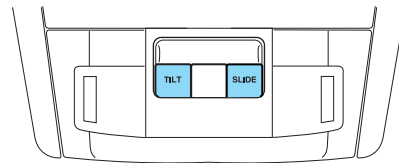

**WARNING:** When closing the moon roof, you should verify that it is free of obstructions and ensure that children and/or pets are not in the proximity of the moon roof opening.

**To close the moon roof:** Pull and release the SLIDE control, the moon roof will close automatically. Press the switch again to stop the moon roof.

**Bounce-back:** When an obstacle has been detected in the moon roof opening as the moon roof is closing, the moon roof will automatically open and stop at a prescribed position.

**Bounce-back override:** To override bounce-back function, pull and hold the SLIDE switch within two seconds of a bounce-back event. The closing force will begin to increase each time the moon roof is closed for the first three closing cycles, with bounce-back active. For example: Bounce-back can be used to overcome the resistance of ice on the moon roof or seals

**To vent the moon roof:** Press and release the TILT control, the moon roof will move to the vent position automatically from any moon roof position. Press the switch again to stop the moon roof. Pull and hold the TILT control to close the moon roof.

The moon roof has a built-in sliding shade that can be manually opened or closed when the glass panel is shut. To close the shade, pull it toward the front of the vehicle.

## Driver Controls

### UNIVERSAL GARAGE DOOR OPENER (IF EQUIPPED)

Your vehicle may be equipped with a universal garage door opener which can be used to replace the common hand-held transmitter.

### Car2U® Home Automation System (if equipped)

The Car2U® Home Automation System is a universal transmitter located in the driver's visor that includes two primary features – a garage door opener and a platform for remote activation of devices within the home. The Car2U® system's garage door opener function replaces the common

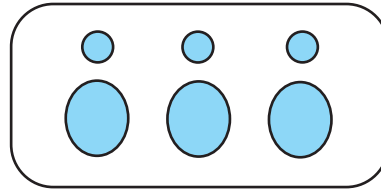

hand-held garage door opener with a three-button transmitter that is integrated into the interior of your vehicle. After being programmed for garage doors, the Car2U® system transmitter can be programmed to operate security devices and home lighting systems.



**WARNING:** Make sure that people and objects are clear of the garage door or security device you are programming. Do not program the Car2U® system with the vehicle in the garage.

Do not use the Car2U® system with any garage door opener that lacks safety stop and reverse features as required by U.S. Federal Safety Standards (this includes any garage door opener manufactured before April 1, 1982).

Be sure to keep the original remote control transmitter for use in other vehicles as well as for future Car2U® system programming. It is also recommended that upon the sale or lease termination of the vehicle, the programmed Car2U® system buttons should be erased for security reasons. Refer to *Erasing the Car2U® Home Automation System buttons* later in this section.

Read the instructions completely before attempting to program the Car2U® system. Because of the steps involved, it may be helpful to have another person assist you in programming the transmitter.

Additional Car2U® system information can be found on-line at [www.learcar2U.com](http://www.learcar2U.com) or by calling the toll-free Car2U® system help line at 1-866-572-2728.

## Driver Controls

### **Types of garage door openers (rolling code and fixed code)**

The Car2U® Home Automation System may be programmed to operate rolling code and fixed code garage door openers.

- Rolling code garage door openers were produced after 1996 and are code protected. Rolling code means the coded signal is changed every time your remote control garage door opener is used.
- Fixed code garage door openers were produced prior to 1996. Fixed code uses the same coded signal every time. It is manually programmed by setting DIP switches for a unique personal code.

If you do not know if your garage door opener is a rolling code or fixed code device, open your garage door opener's remote control battery cover. If a panel of DIP switches is present your garage door opener is a fixed code device. If not, your garage door opener is a rolling code device.

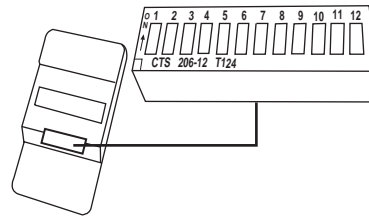

### **Rolling code programming**

**Note:** Programming the rolling code garage door opener involves time-sensitive actions. Read the entire procedure prior to beginning so you will know which actions are time-sensitive. If you do not follow the time-sensitive actions, the device will time out and you will have to repeat the procedure.

**Note:** Do not program the Car2U® system with the vehicle in the garage. Make sure that your key is on and engine off while programming the transmitter.

## Driver Controls

1. Firmly press the two outer Car2U® system buttons for 1–2 seconds, then release.

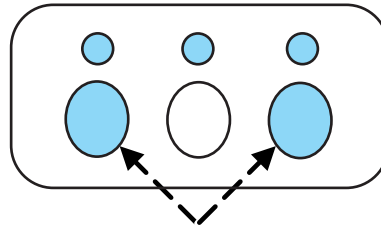

2. Go to the garage to locate the garage door opener motor and its “learn” button. You may need a ladder to reach the unit and you may need to remove the unit’s cover or light lens to locate the “learn” button. Press the “learn” button, after which you will have 10–30 seconds to return to your vehicle and complete the following steps. If you cannot locate the “learn” button, refer to the Owner’s Guide of your garage door opener or call the toll-free Car2U® system help line at 1-866-57Car2U (1-866-572-2728).

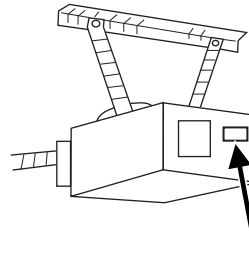

3. Return to your vehicle. Press and hold the Car2U® system button you would like to use to control the garage door. You may need to hold the button from 5–20 seconds, during which time the selected button indicator light will blink slowly. Immediately (within

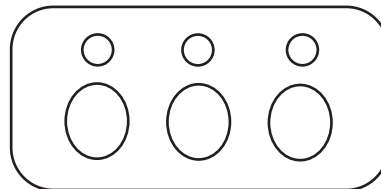

1 second) release the button once the garage door moves. When the button is released, the indicator light will begin to blink rapidly until programming is complete.

4. Press and release the button again. The garage door should move, confirming that programming is successful. If your garage door does not operate, repeat the previous steps in this section.

After successful programming, you will be able to operate your Car2U® system by pressing the button you programmed to activate the opener. The indicator light above the selected button will turn on to confirm that the Car2U® system is responding to the button command.

## Driver Controls

To program another rolling code device such as an additional garage door opener, a security device or home lighting, repeat Steps 1 through 4 substituting a different function button in Step 3 than what you used for the garage door opener. For example, you could assign the left-most button to the garage door, the center button to a security device, and the right-most button to another garage door opener.

**Note:** The Car2U® system allows for three devices to be programmed. If you need to change or replace any of the three devices after it has been initially programmed, it is necessary to erase the current settings using the *Erasing the Car2U® Home Automation System buttons* procedure and then programming all of the devices being used.

### Fixed code programming

**Note:** Do not program the Car2U® system with the vehicle in the garage. Make sure that your key is on and engine off while programming the transmitter.

1. To program units with fixed code DIP switches, you will need the garage door hand-held transmitter, paper and a pen or pencil.
2. Open the battery cover and record the switch settings from left to right for all 8 to 12 switches. Use the figure below:

When a switch is in the up, on, or + position, circle “L.”

When a switch is in the middle, neutral, or 0 position, circle “M.”

When a switch is in the down, off, or – position, circle “R.”

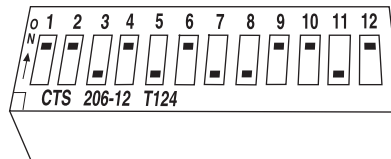

Switch position	1	2	3	4	5	6	7	8	9	10	11	12
Up, on or +	L	L	L	L	L	L	L	L	L	L	L	L
Middle, neutral or 0	M	M	M	M	M	M	M	M	M	M	M	M
Down, off or –	R	R	R	R	R	R	R	R	R	R	R	R

L=left; M=middle; R=right



## Driver Controls

3. To input these positions into the Car2U® system, simultaneously press all three Car2U® system buttons for a few seconds and then release to put the device into programming mode. The indicator lights will blink slowly. Within 2.5 minutes enter your corresponding DIP switch settings from left to right into your Car2U® system by pressing and releasing the buttons corresponding to the settings you circled.

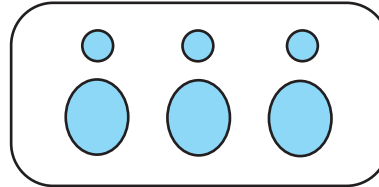

4. After inputting switch settings, simultaneously press and release all three Car2U® system buttons. The indicator lights will turn on.

5. Press and hold the Car2U® system button you would like to use to control the garage door. Immediately (within 1 second) release the button once the garage door moves. During this time the selected button indicator light will blink slowly. Do not release the button until you see the garage door move. Most garage doors open quickly. You may need to hold the button from 5–55 seconds before observing movement of the garage door.

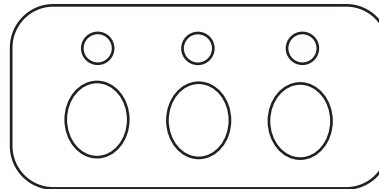

6. The indicator light will (begin to) blink rapidly until programming is complete. If your garage door opener does not operate following these steps, repeat Steps 2 through 6. Otherwise, call the toll-free Car2U® help line at 1-866-57Car2U (1-866-572-2728).

After successful programming, you will be able to operate your Car2U® system by pressing the button you programmed to activate the opener. The indicator light above the selected button will turn on to confirm that the Car2U® system is responding to the button command.

### **Erasing the Car2U® Home Automation System buttons**

**Note:** The system allows for three devices to be programmed. If you need to change or replace any of the three devices after it has been initially programmed, it will be necessary to erase the current settings using the procedure below and then reprogramming all of the devices being used.

## Driver Controls

To erase programming on the Car2U® system (individual buttons cannot be erased), use the following procedure:

1. Firmly press the two outside Car2U® system buttons simultaneously for approximately 20 seconds until the indicator lights begin to blink rapidly. The indicator lights are located directly above the buttons.

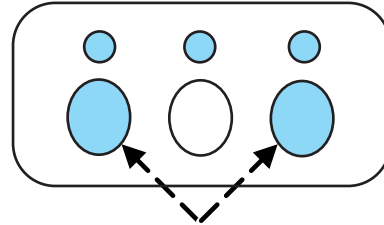

2. Once the indicator lights begin to blink, release your fingers from the buttons. The codes for all buttons are erased.

If you sell your vehicle equipped with the Car2U® system, it is recommended that you erase the programming for security reasons.

### **FCC and RSS-210 Industry Canada Compliance**

The Car2U® system complies with Part 15 of the FCC rules and with RSS-210 of Industry Canada. Operation is subject to the following two conditions: (1) This device may not cause harmful interference, and (2) This device must accept any interference received including interference that may cause undesired operation.

Changes and modifications to the Car2U® system transmitter by other than an authorized service facility could void authorization to use the equipment.

### **POSITIVE RETENTION FLOOR MAT**

 **WARNING:** Do not install additional floor mats on top of the factory installed floor mats as they may interfere with the accelerator or the brake pedals.

Position the floor mat so that the eyelet is over the retention post and press down to lock in. Make sure that the mat does not interfere with the operation of the accelerator or the brake pedal. To remove the floor mat, reverse the installation procedure.

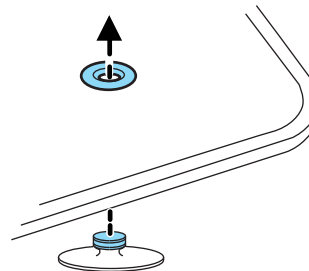

## Driver Controls

### POWER LIFTGATE (IF EQUIPPED)

The liftgate can be operated by the following:

- Instrument panel control button
- Transmitter button
- Outside control button
- Control button in the rear cargo area

**Note:** The liftgate can be reversed with a second press on a control button or transmitter and can be manually closed at any time.

### Opening and closing the power liftgate:



**WARNING:** Make sure all persons are clear of the power liftgate area before using the power liftgate control.



**WARNING:** Keep keys out of reach of children. Do not allow children to play near an open or moving power liftgate.

The liftgate will only operate with the vehicle in P (Park). The chime will beep once if conditions are not correct to start an operation. These conditions include:

- The ignition is in on and the transmission is not in P (Park)
- The battery voltage is below the minimum operating voltage
- The vehicle speed is at or above 3 mph (5 km/h)

If the liftgate reverses and starts to close after a open request, a fast continuous chime indicates excessive load on the gate or a possible strut failure. If any excessive load is removed and you still have a faster chime, have the system serviced immediately by your authorized dealer.

Do not attempt to manually force the liftgate to travel faster than the power system will permit. This will activate the obstacle detection feature.

**Note:** Cycling the ignition prior to completely latching the liftgate could result in damage to the liftgate and/or its power components. Make sure the liftgate is fully latched before operating the vehicle.

Care should be exercised in starting the engine before the liftgate is fully closed (latched). If the ignition is cycled during a liftgate power close cycle and the liftgate is 6-10 in. (15-24 cm) from being latched, the liftgate may reverse to the full open position. Verify that the gate is

## Driver Controls

closed before operating or moving the vehicle, especially in an enclosure, like a garage or a parking structure. The liftgate or its components could be damaged in an enclosure, if the liftgate is open.

When power operating the liftgate at temperatures below 32° F (0° C), the liftgate may stop about 5 in. (13 cm) from the full open position. The liftgate can be fully opened by pushing it upward to the maximum open position.

### To open the liftgate from the instrument panel:

Press the button once to open the liftgate, press it again to close.

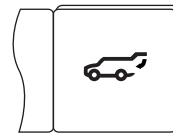

### To open the liftgate with the remote entry transmitter:

Refer to *Remote entry system* in the *Locks and Security* chapter.

### To open the liftgate with outside liftgate control button (manual actuation):

1. Unlock the liftgate with the remote entry transmitter or power door unlock control.
2. Press the control button located on the inside of the liftgate handle.

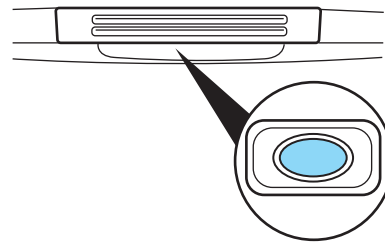

**Note:** For the best performance allow the power system to open the liftgate after releasing the control button. Continued upward force after unlatching may activate the obstacle detection feature and stop the power operation.

**Note:** If weight is added to the gate (bike rack, snow, etc.) the gate may automatically start a power close event immediately after a power open. In this mode a unique continuous chime will sound.

## Driver Controls

### To close the liftgate with the rear cargo area control button:

Press and release the control on the left rear quarter panel to close the liftgate. The chime will beep once if conditions are not correct to start an operation (i.e., the vehicle is out of park). In a normal close, the chime will begin just before the gate starts to move and continue for total of three seconds.

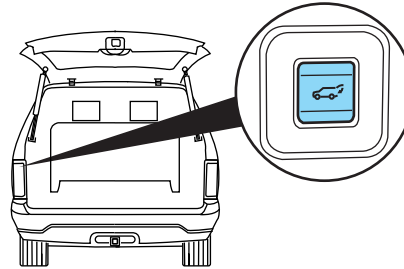

Press and release the control to open or reverse the liftgate.

Rear cargo area control button will not open the liftgate when the liftgate is latched.



**WARNING:** Keep clear of the liftgate when activating the rear switch.

### To manually operate the liftgate:

1. Disable the liftgate power function, refer to *Message center* in the *Instrument Cluster* chapter.
2. Open and close the liftgate as you would a standard liftgate.

**Note:** In case of operation in extreme cold  $-40^{\circ}\text{F}$  ( $-40^{\circ}\text{C}$ ), or on extreme inclines, manual operation of the liftgate is suggested.

### Obstacle detection

The power liftgate system is equipped with an obstacle detection feature.

If the power liftgate is closing, the system is designed to reverse to full open when it encounters a solid obstacle. A three second chime is also sounded when an obstacle is detected. Once the obstacle is removed, the liftgate can be closed under power.

If the power liftgate is opening, the system is designed to stop when it encounters a solid obstacle. A chime will sound for three seconds while the obstacle is present.

## Driver Controls

### Resetting the power liftgate:

If any of these conditions occur, the power liftgate may not operate and must be reset:

- A low voltage or dead battery
- Disconnected battery
- The liftgate is manually closed and left ajar (unlatched)

To reset the power liftgate:

1. Disconnect the battery for 20 seconds then, reconnect the battery.
2. Manually close and fully latch the liftgate.
3. Power open the liftgate by using the remote entry transmitter or instrument panel button.

**Note:** If the power liftgate system is turned off in the message center, the system cannot be activated with the outside release handle or rear cargo area control button. The system will need to be turned on to resume operation with the outside release handle or rear cargo area control button. The power liftgate is still operational through the use of the remote entry transmitter and IP button when the power liftgate is turned off in the message center.

### Liftgate ajar signal

If the liftgate or liftgate glass are not fully latched, you will receive a message on the instrument panel. If you see this message, check both the liftgate glass and liftgate door to ensure they are fully latched.



**WARNING:** Make sure the liftgate is closed to prevent exhaust fumes from being drawn into the vehicle. If you must drive with the liftgate open, keep the vents open so outside air comes into the vehicle.

### Liftgate window

To open the liftgate window, press the button in the center of the liftgate above the license plate.

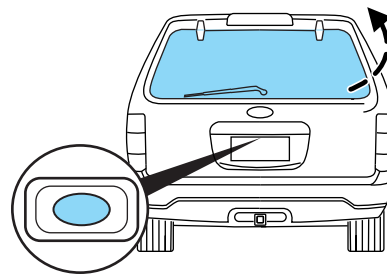

## Driver Controls

### MANUAL LIFTGATE (IF EQUIPPED)

The liftgate area is only intended for cargo, not passengers. You can open and close the liftgate from outside the vehicle. The liftgate cannot be opened from the cargo area control button, only closed.

**Note:** In the event of a power failure, the latch can be accessed and released from the inside using the access panel on the liftgate trim.

To open the liftgate, press the control button located on the inside of the liftgate handle to unlatch the liftgate, then pull on the handle to access the cargo area.

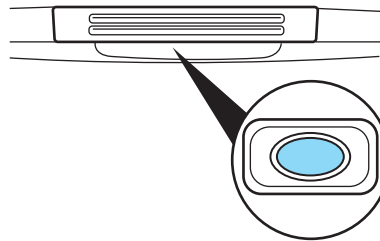

- Do not open the liftgate or liftgate glass in a garage or other enclosed area with a low ceiling. If the liftgate glass is raised and the liftgate is also opened, both liftgate and glass could be damaged against a low ceiling.
- Do not leave the liftgate or liftgate glass open while driving. Doing so could cause serious damage to the liftgate and its components as well as allowing carbon monoxide to enter the vehicle.

 **WARNING:** Make sure the liftgate is closed to prevent exhaust fumes from being drawn into the vehicle. If you must drive with the liftgate open, keep the vents open so outside air comes into the vehicle.

### CARGO MANAGEMENT SYSTEM (IF EQUIPPED)

The cargo management system consists of a storage compartment located in the floor of the rear cargo area.

1. To open, lift up on the handle and cover.
2. To close, lower the cover and press down on the handle until the latch clicks.

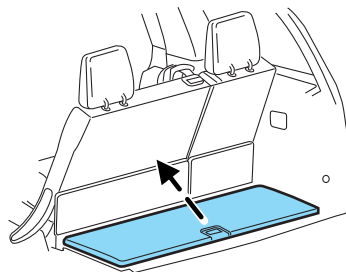

## Driver Controls

### Cargo shelf/divider (if equipped)

The cargo shelf/divider is located behind the rear seat of your vehicle. The shelf has two positions: Flat shelf which pivots up and snaps into place or a divider which pivots up and snaps vertically into place. Do not put more than 30 lb (14 kg) on the shelf.

To move the shelf to the shelf position, pull up and pivot the shelf over the channels on the side trim panels and snap the shelf ends in the channels.

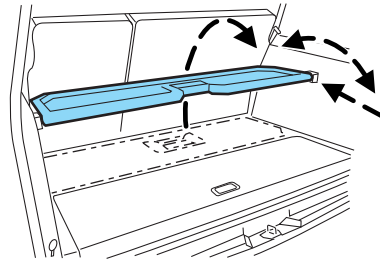

To move the shelf to the divider position, pull up and pivot the shelf over the channels on the side trim panels and snap vertically in place.

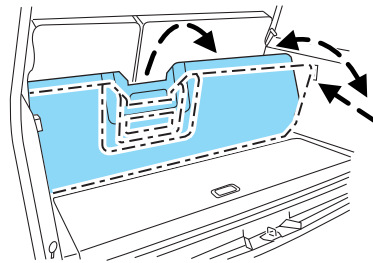

**WARNING:** Do not load any objects on the shelf that may obstruct your vision or strike occupants of the vehicle in the case of a sudden stop or collision.



**WARNING:** Do not place people or pets on or under the parcel shelf.



## Driver Controls

### LUGGAGE RACK

Your vehicle is equipped with a roof rack for transporting items on the exterior of the vehicle. The maximum recommended load to be carried on the roof rack is 200 lb (90 kg), evenly distributed. The cross-bars can be adjusted by using the thumbwheels at each end. Use the tie-down loops on the thumbwheels to secure load.

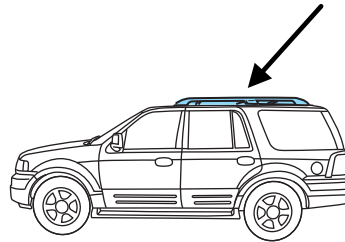

To adjust the position of the cross-bar (if equipped):

1. Loosen the thumbwheel at both ends of the cross-bar (both cross-bars are adjustable).
2. Slide the cross-bar to the desired location.
3. Firmly retighten the thumbwheels at each end of the cross-bar.

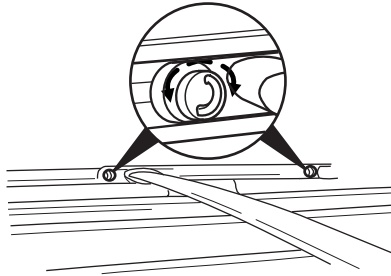

Be sure to check that the thumbwheels are tight each time load is added or removed from the roof rack, and periodically while traveling.

Always ensure that the load is secure before traveling.

Ford Motor Company recommends loading the roof rack only when equipped with (optional) crossbars, to avoid unintended damage to the roof panel.

## Locks and Security

### KEYS

Your vehicle may be equipped with two integrated keyhead transmitters (IKTs). The key blade functions as a programmed key which starts the vehicle and unlocks/locks all the doors. The transmitter portion functions as the remote entry transmitter.

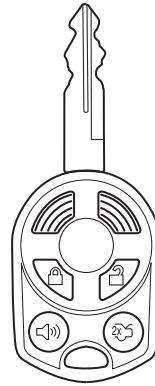

Your IKTs are programmed to your vehicle; using a non-programmed key will not permit your vehicle to start. If you lose your authorized dealer supplied IKTs, replacement IKTs are available through your authorized dealer. Standard SecuriLock® keys without remote entry transmitter functionality can also be purchased from your authorized dealer if desired.

Always carry a spare key with you in case of an emergency.

For more information regarding programming replacement IKTs, refer to the *SecuriLock® passive anti-theft system* section later in this chapter.

**Note:** Your vehicle's IKTs were issued with a security tag that provides important vehicle key cut information. It is recommended that you keep the tag in a safe place for future reference.

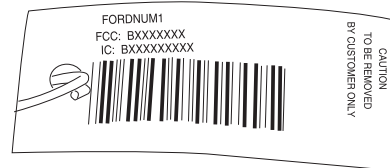

## Locks and Security

### MYKEY™

The MyKey™ feature allows you to program a restricted driving mode to promote good driving habits. All but one of the keys programmed to the vehicle can be activated as a MyKey™. The key will remain restricted until MyKey™ is cleared. Any remaining keys are referred to as an “administrator key” or admin key. The admin key can be used to create a MyKey™, program optional MyKey™ settings, and clear the MyKey™ feature. When the MyKey™ feature is enabled the user can use system check in the message center to see how many MyKeys™ and admin keys are programmed to the vehicle, and how many total miles have been driven with the MyKey™ active.

### MyKey™ restricted features

#### Standard settings – These settings cannot be changed

- The audio system will be muted whenever Belt-Minder® is activated until the safety belts are buckled. Refer to the *Seating and Safety Restraints* chapter for a detailed description of Belt-Minder® operation.
- Low fuel warnings are displayed in the message center followed by a chime when the distance to empty value reaches 75 miles (120 km).
- The reverse sensing system cannot be turned off.

#### Optional settings – These settings can be changed

- Vehicle speed is limited to 80 mph (130 km/h). Visual warnings are displayed followed by a chime when the vehicle speed has reached 80 mph (130 km/h).
- Visual warnings are displayed followed by a chime when a preselected vehicle speed of 45, 55 or 65 mph (75, 90, or 105 km/h) is exceeded
- The maximum volume of the audio system is limited to 45%. MYKEY VOLUME LIMITED will be displayed in the radio or (if equipped) navigation screen when attempting to exceed the limited volume
- The AdvanceTrac® system cannot be turned off. When this optional setting is on, the MyKey™ user will not be able to deactivate the system. **Note:** It may be beneficial to deactivate the AdvanceTrac® system if the vehicle is stuck in snow, mud, or sand.

### Create a MyKey™

To program MyKey™ on one of the keys programmed to the vehicle, insert the key that you want to make a MyKey™ into the ignition. Turn the ignition on. Use the message center buttons to do the following:

1. Press SETUP until PRESS RESET TO CREATE MYKEY is displayed.

## Locks and Security

2. Press and release the RESET button. HOLD RESET TO CONFIRM MYKEY will be displayed.
3. Press and hold the RESET button for two seconds until MARK THIS AS RESTRICTED is displayed.
4. Wait until KEY RESTRICTED AT NEXT START is displayed.

MyKey™ is successfully programmed. Make sure you label it so you can distinguish it from the admin keys. **Note:** To program the optional settings go to Step 2 in the *Programming MyKey™ optional settings* section. If your vehicle is equipped with remote start, see the *Using MyKey™ with remote start systems* section.

**Note:** The MyKey™ can be cleared within the same key cycle that it was created, otherwise a standard key (administrator key) is required to clear the MyKey™ programming. To clear all MyKeys™ go to Step 2 in the *Clear MyKey™* section.

### Programming MyKey™ optional settings

Turn the ignition on using an admin key. To program the optional settings, use the message center buttons to do the following:

1. Press SETUP until RESET FOR MYKEY SETTINGS is displayed.
2. Press and release the RESET button to display MyKey™ setup menus. The first menu shown is:

MYKEY MAX MPH <80 MPH> OFF

3. If you don't want to change the maximum speed setting, press the SETUP button to display the next menu. The remaining menus appear as follows with the default settings shown:

MYKEY MPH TONES 45 55 65 <OFF>

MYKEY VOLUME LIMIT <ON> OFF

MYKEY ADVTRAC CTRL ON <OFF>.

4. On any of the menus press RESET to highlight your choice with the <...>.
5. Press SETUP to enter your choice. The next optional setting will be displayed.
6. Repeat Steps 4 and 5 until you are done changing the optional settings.

### Clear MyKey™

To reset all MyKeys™ as admin keys do the following:

1. Turn the vehicle on using the admin key.
2. Press SETUP until PRESS RESET TO CLEAR MYKEY is displayed.

## Locks and Security

3. Press and release the RESET button. HOLD RESET TO CONFIRM CLEAR is displayed.
4. Press and hold the RESET button for two seconds until ALL MYKEYS CLEARED is displayed.

### Check MyKey™ system status

The vehicle system check will provide the status of the following MyKey™ parameters:

- MYKEY MILES — This odometer only tracks mileage when a MyKey™ is used. If mileage does not accumulate as expected, then the MyKey™ is not being used by the intended user. The only way to reset this odometer to zero is by clearing MyKey™. If this odometer is lower than the last time you checked, then the MyKey™ system has been recently cleared.
- # MYKEY(S) PROGRAMMED — Indicates how many MyKeys™ are programmed to the vehicle. Can be used to detect deletion of a MyKey™.
- # ADMIN KEYS PROGRAMMED — Indicates how many admin keys are programmed to the vehicle. Can be used to detect if an additional spare key has been programmed to the vehicle

Refer to *Message center* in the *Instrument Cluster* chapter for MyKey™ system warnings displays.

### Using MyKey™ with remote start systems

MyKey™ is not compatible with non-Ford approved aftermarket remote start systems. If you choose to install a remote start system please see your authorized dealer for a Ford approved remote start system.

When using a Ford-approved remote start system, the default settings will recognize the remote start system as an additional admin key with its associated privileges. You should program the remote start system as a MyKey™ in addition to the key that you have already programmed as a MyKey™. To program the remote start system as MyKey™, do the following:

1. Enter the vehicle and close all doors.
2. Remote start the vehicle using a remote start fob.
3. Follow Steps 1-4 in the *Create a MyKey™* section.

**Note:** For all vehicles, the number of MYKEY(S) PROGRAMMED or ADMIN KEYS PROGRAMMED that is displayed in the MyKey™ system status menus will include the remote start system as an additional key in the total count. See the *Check MyKey™ system status* section.

## Locks and Security

**Note:** For all vehicles with remote start installed, it is possible to program all original vehicle keys as MyKeys™, in which case, you will need to use your remote start system to reset all MyKeys™ as admin keys by doing the following:

1. Enter the vehicle, close all doors.
2. Remote start the vehicle using your remote start fob.
3. Follow Steps 1-4 in the *Clear MyKey™* section.

### Troubleshooting

Condition	Potential Causes
Can't create a MyKey™	<ul style="list-style-type: none"> <li>• Key in the ignition is already a MyKey™</li> <li>• Key in the ignition is the last remaining admin key (there always has to be at least one admin key)</li> <li>• SecuriLock® passive anti-theft system is disabled or in unlimited mode</li> <li>• Vehicle has been started using a remote start system that is programmed as MyKey™. Refer to <i>Using MyKey™ with remote start systems</i> section.</li> </ul>
Cannot program the MyKey™ optional settings	<ul style="list-style-type: none"> <li>• Key in the ignition is a MyKey™</li> <li>• No MyKeys™ are programmed to the vehicle. Refer to <i>Create a MyKey™</i> section</li> <li>• Vehicle has been started using a remote start system that is programmed as MyKey™. Refer to <i>Using MyKey™ with remote start systems</i> section.</li> </ul>

## Locks and Security

Condition	Potential Causes
Cannot clear MyKey™	<ul style="list-style-type: none"> <li>• Key in the ignition is a MyKey™</li> <li>• No MyKeys™ are programmed to the vehicle. Refer to <i>Create a MyKey™</i> section</li> <li>• Vehicle has been started using a remote start system that is programmed as MyKey™. Refer to <i>Using MyKey™ with remote start systems</i> section.</li> </ul>
Lost the only admin key	<ul style="list-style-type: none"> <li>• Purchase a new key from your authorized dealer</li> </ul>
Lost any key	<ul style="list-style-type: none"> <li>• For programming spare keys, refer to the <i>Programming spare keys</i> section in this chapter.</li> </ul>
I accidentally programmed all keys as MyKeys™	<ul style="list-style-type: none"> <li>• Vehicle has a remote start system that is recognized as an admin key. Refer to the <i>Using MyKey™ with remote start systems</i> section to reset all MyKeys™ as admin keys.</li> </ul>
MyKey™ Programmed total includes one additional key	<ul style="list-style-type: none"> <li>• Unknown key has been programmed to the vehicle as a MyKey™.</li> <li>• Vehicle is equipped with a remote start system. Refer to <i>Using MyKey™ with remote start systems</i> section.</li> </ul>
Admin Keys Programmed total includes one additional key	<ul style="list-style-type: none"> <li>• Unknown key has been programmed to the vehicle as admin key.</li> <li>• Vehicle is equipped with a remote start system. Refer to <i>Using MyKey™ with remote start systems</i> section.</li> </ul>
MyKey™ miles do not accumulate	<ul style="list-style-type: none"> <li>• MyKey™ is not being used by the intended user.</li> <li>• MyKey™ system has been recently cleared.</li> </ul>

## Locks and Security

### POWER DOOR LOCKS

Press control to unlock all doors.

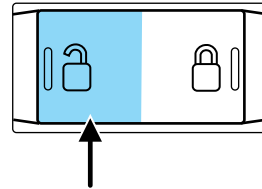

Press control to lock all doors.

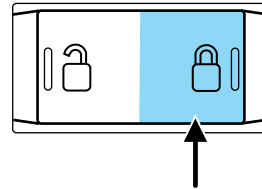

### Smart locks

This feature helps to prevent you from locking yourself out of the vehicle if your key is still in the ignition.

When you open one of the front doors or the liftgate and you lock the vehicle with the power door lock control (on the driver or passenger door trim panel), all the doors will lock, then all doors will automatically unlock reminding you that your key is still in the ignition.

The vehicle can still be locked, with the key in the ignition, by locking the driver's door with a key, using the lock control on the remote entry transmitter portion of your integrated keyhead transmitter, or locking the vehicle with the keyless entry keypad.

If both front doors and the liftgate are closed, the vehicle can be locked from any method, regardless of whether the key is in the ignition or not.

### Autolock

The autolock feature will lock all the doors, liftgate and liftgate window when:

- all doors are closed,
- the ignition is in the on position,
- you shift into any gear putting the vehicle in motion, and
- the vehicle attains a speed greater than 12 mph (20 km/h).



## Locks and Security

The autolock feature repeats when:

- any door is opened then closed while the ignition is in the on position and the vehicle speed is 9 mph (15 km/h) or lower, and
- the vehicle attains a speed greater than 12 mph (20 km/h).

### **Deactivating/activating autolock**

Your vehicle comes with the autolock feature enabled. There are four methods to enable/disable this feature:

- Through your authorized dealer, or
- Performing the power door lock control procedure,
- Performing the keyless entry keypad (if equipped) procedure, or
- Performing the message center (if equipped) procedure.

Before following the activation or deactivation procedures, make sure that the anti-theft system is not armed, ignition is in the off position, and all vehicle doors, liftgate and liftgate window are closed.

### **Power door unlock/lock procedure**

You must complete Steps 1-5 within 30 seconds or the procedure will have to be repeated. If the procedure needs to be repeated, you must wait 30 seconds. **Note: All** doors must be closed and remain closed throughout the configuration process.

1. Turn the ignition to the on position.
2. Press the power door unlock control three times.
3. Turn the ignition from the on to the off position.
4. Press the power door unlock control three times.
5. Turn the ignition back to the on position. The horn will chirp.
6. Press the unlock control, then press the lock control. The horn will chirp once if autolock was deactivated or twice (one short and one long chirp) if autolock was activated.
7. Turn the ignition to the off position. The horn will chirp once to confirm the procedure is complete.

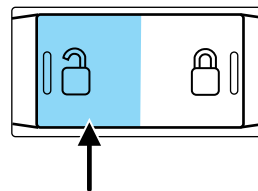

## Locks and Security

### **Keyless entry keypad procedure**

1. Turn the ignition to the off position.
2. Close all doors, the liftgate and liftgate window.
3. Enter 5–digit entry code
4. Press and hold the 3 • 4. While holding the 3 • 4 press the 7 • 8.
5. Release the 7 • 8.
6. Release the 3 • 4.

The user should receive a horn chirp to indicate the system has been disabled or a chirp followed by a honk to indicate the system has been enabled.

### **Message center procedure**

For information on activating/deactivating the autolock feature using the vehicle's message center, refer to *Message center* information in the *Instrument Cluster* chapter.

### **Autounlock feature**

The autounlock feature will unlock all the doors, liftgate, and liftgate window when:

- the ignition is in the on position, all the doors are closed, and the vehicle has been in motion at a speed greater than 12 mph (20 km/h);
- the vehicle has then come to a stop and the ignition is turned to the off or accessory position; and
- the driver door is opened within 10 minutes of the ignition being transitioned to the off or accessory position.

**Note:** The doors will not autounlock if the vehicle has been electronically locked before the driver door is opened.

### **Deactivating/activating autounlock feature**

Your vehicle comes with the autounlock features activated; there are four methods to enable/disable this feature:

- Through your authorized dealer,
- by using a power door unlock/lock sequence,
- using a keypad procedure (if equipped), or
- by using the instrument cluster message center (if equipped). Refer to *Message center* in the *Instrument Cluster* chapter.

**Note:** The autounlock feature can be activated/deactivated independently of the autolock feature.

## Locks and Security

### **Power door lock switch autounlock enable/disable procedure**

Before starting, ensure the ignition is in the off position and all vehicle doors are closed. You must complete Steps 1–5 within 30 seconds or the procedure will have to be repeated. If the procedure needs to be repeated, wait a minimum of 30 seconds before beginning again.

1. Place the key in the ignition and turn the ignition to the on position.
2. Press the power door unlock control three times.
3. Turn the ignition from the on position to the off position.
4. Press the power door unlock control three times.
5. Turn the ignition back to the on position. The horn will chirp one time to confirm programming mode has been entered and is active.
6. To enable/disable the autounlock feature, press the lock control, then press the unlock control. The horn will chirp once if autounlock was deactivated or twice (one short and one long chirp) if autounlock was activated.
7. Turn the ignition to the off position. The horn will chirp once to confirm the procedure is complete.

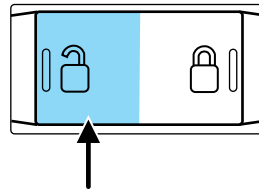

### **Keyless entry keypad autounlock enable/disable procedure**

1. Turn the ignition to the off position.
2. Close all the doors.
3. Enter factory-set 5-digit entry code.
4. Press and hold the 3 • 4. While holding the 3 • 4, press and release the 7 • 8. While still holding the 3 • 4, press and release the 7 • 8 a second time.
5. Release the 3 • 4.

The user should receive a **horn chirp** to indicate the system has been disabled or a chirp followed by a honk to indicate the system has been enabled.

### **Message center procedure**

For information on activating/deactivating the autounlock feature using the vehicle's message center, refer to *Message center* information in the *Instrument Cluster* chapter.

## Locks and Security

### CHILDPROOF DOOR LOCKS

Childproof door locks prevent opening of the rear doors from inside the vehicle regardless of the state of the main locks (locked or unlocked).

The childproof locks are located on the rear edge of each rear door and must be set separately for each door. Setting the lock for one door will not automatically set the lock for both doors.

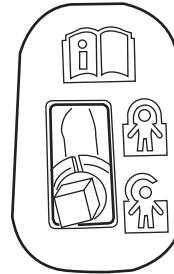

Move lock control up to engage the childproof lock. Move control down to disengage childproof locks.

### REMOTE ENTRY SYSTEM

The integrated keyhead transmitter (IKT) complies with part 15 of the FCC rules and with RSS-210 of Industry Canada. Operation is subject to the following two conditions: (1) This device may not cause harmful interference, and (2) This device must accept any interference received, including interference that may cause undesired operation.

**Changes or modifications not expressly approved by the party responsible for compliance could void the user's authority to operate the equipment.**

## Locks and Security

The typical operating range for your IKT is approximately 33 feet (10 meters). A decrease in operating range could be caused by:

- weather conditions,
- nearby radio towers,
- structures around the vehicle, or
- other vehicles parked next to your vehicle.

The IKT allows you to:

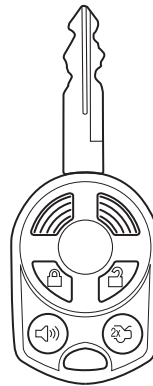

- remotely unlock the vehicle doors.
- remotely lock all the vehicle doors.
- remotely open the power liftgate or manual liftgate window (if equipped).
- activate the personal alarm.
- arm and disarm the perimeter anti-theft system.
- operate the illuminated entry feature.



The remote entry lock/unlock feature operates in any ignition position except while the key is held in the start position. The panic feature operates with the key in the off position.

If there are problems with the remote entry system, make sure to take **ALL integrated keyhead transmitters** with you to the authorized dealer in order to aid in troubleshooting the problem.



### Unlocking the doors/two stage unlock

1. Press  and release to unlock the driver's door. **Note:** The interior lamps and parking lamps will illuminate.
2. Press  and release again within three seconds to unlock all the doors.



The remote entry system activates the illuminated entry feature; this feature turns on the lamps for 25 seconds or until the ignition is turned to the on position.

The battery saver feature will turn off the lamps 10 minutes after the ignition is turned to the off position.

## Locks and Security

Two stage unlocking may be disabled or re-enabled by simultaneously pressing the  and  controls on the IKT for four seconds (disabling two stage unlock allows all vehicle doors to unlock simultaneously). The parking lamps will flash twice to indicate that two-stage unlock was enabled or disabled.



### Locking the doors

1. Press  and release to lock all the doors. The parking lamps will illuminate.
2. Press  and release again within three seconds to confirm that all the doors are closed. **Note:** The doors will lock again, the horn will chirp and the turn lamps will illuminate once if all the doors and liftgate are closed.

**Note:** If any door or the liftgate is not closed, or if the hood is not closed in vehicles equipped with the perimeter alarm feature, the horn will chirp twice and the turn lamps will not flash.

### Opening the power liftgate or liftgate window (if equipped)

If equipped with a power liftgate, this control will not operate the liftgate window.

- Press  twice within three seconds to open the power liftgate (if equipped) or
- Press  twice within three seconds to unlatch the liftgate window (if not equipped with a power liftgate).



**WARNING:** Make sure all persons are clear of the power liftgate area before using the control.

To close the power liftgate, press the control twice.

If the power liftgate stops mid travel, it may have detected an obstacle. Check to ensure the power liftgate swing zone is free from obstruction and reset the power assist by manually closing the power liftgate. Normal operation can then be resumed.



**WARNING:** Make sure the power liftgate is closed to prevent exhaust fumes from being drawn into the vehicle. This will also prevent passengers and cargo from falling out. If you must drive with the liftgate open, keep the vents open so outside air comes into the vehicle.

## Locks and Security

### Car finder

Press  twice within three seconds. The horn will chirp and the turn lamps will flash. It is recommended that this method be used to locate your vehicle, rather than using the panic alarm.

### Sounding a panic alarm

Press  to activate the alarm. The horn will sound and the turn lamps will flash for a maximum of three minutes. Press again or turn the ignition to the on position to deactivate, or wait for the alarm to time out in three minutes.

**Note:** The panic alarm will only operate when the ignition is in the off position.



### Memory feature (seat, mirrors and adjustable pedals)

The integrated keyhead transmitter (IKT) allows you to recall the memory seat/power mirrors/adjustable pedals feature.

Press  to automatically move the driver seat, power mirrors and adjustable pedals to the desired memory position. The mirrors will move to the programmed position and the seat will move to the easy entry position. The seat will move to the final position when the key is in the ignition (if easy entry feature is enabled).

### Programming memory feature to the transmitter

To activate this feature:

1. Move the driver seat, power mirrors, and adjustable pedals to the desired positions using the associated controls.
2. Press and hold button 1 for five seconds. A tone will be heard after two seconds confirming memory position has been set. Continue to hold until a second tone is heard after five seconds.
3. Within three seconds press the .
4. A tone will be heard when the transmitter programming is complete.
5. Press the .
6. Repeat this procedure for memory 2 and another transmitter if desired.

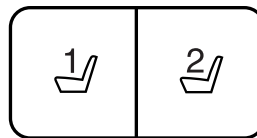

## Locks and Security

### **Deprogramming memory feature from the transmitter**

To deactivate this feature:

1. Press and hold either the 1 or 2 button on the driver's door for five seconds. A tone will be heard after 1½ seconds when the memory store is done, continue to hold until a second tone is heard after five seconds.
2. Within three seconds press the .
3. A tone will be heard when the deactivation is complete.
4. Repeat this procedure for another transmitter if desired.

### **Replacing the battery**

The integrated keyhead transmitter (IKT) or intelligent access key (IA key) uses one coin type three-volt lithium battery CR2032 or equivalent.

#### **Integrated keyhead transmitter (IKT)**

To replace the battery:

1. Twist a thin coin in the slot near the key ring to remove the battery cover (1).

**Note:** Do not wipe off any grease on the battery terminals on the back surface of the circuit board.

2. Carefully peel up the rubber gasket (2) from the transmitter if it does not come off with battery cover.

3. Remove the old battery (3).

**Note:** Please refer to local regulations when disposing of transmitter batteries.

4. Insert the new battery. Refer to the instructions inside the IKT for the correct orientation of the battery. Press the battery down to ensure that the battery is fully seated in the battery housing cavity.

5. Snap the battery cover back onto the key.

**Note:** Replacement of the battery will **not** cause the IKT or IA key to become de-programmed from your vehicle. They should operate normally after battery replacement.

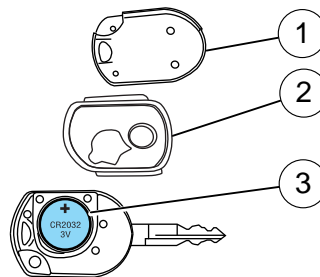



## Locks and Security

### Replacing lost integrated keyhead transmitters (IKTs)

If you would like to have your integrated keyhead transmitters reprogrammed because you lost one, or would like to buy additional IKTs, you can either reprogram them yourself, or take **all IKTs** to your authorized dealer for reprogramming.

### How to reprogram your integrated keyhead transmitters (IKTs)

To program a new integrated keyhead transmitter yourself, refer to *Programming spare keys* in the *SecuriLock® passive anti-theft system* section of this chapter. **Note:** At least two IKTs are required to perform this procedure yourself.

### Illuminated entry

The interior lamps, parking lamps and puddle lamps (if equipped) illuminate when the integrated keyhead transmitter or the keyless entry system keypad is used to unlock the door(s).

The illuminated entry system will turn off the lights if:

- the ignition is turned to the on position, or
- the integrated keyhead transmitter lock control is pressed, or
- the vehicle is locked using the keyless entry keypad, or
- after 25 seconds of illumination.

The inside will not turn off if:

- they have been turned on with the dimmer control, or
- any door is open.

### Illuminated exit

- When all vehicle doors are closed and the key is removed from the ignition, the interior dome lamps, parking lamps and the puddle lamps (if equipped) will illuminate.

The lamps will turn off if all the doors remain closed and

- 25 seconds elapse, or
- the key is inserted in the ignition.

### Battery saver

The battery saver will shut off the lamps 10 minutes after the ignition has been turned to the off position.

- If the dome lamps were turned on using the panel dimmer control, the battery saver will shut them off 10 minutes after the ignition has been turned to the off position.

## Locks and Security

- If the courtesy lamps were turned on because one of the vehicle doors or the liftgate was opened, the battery saver will shut them off 10 minutes after the ignition has been turned to the off position.
- The battery saver will shut off the headlamps 10 minutes after the ignition has been turned to the off position.

### SECURICODE™ KEYLESS ENTRY SYSTEM

You can use the keyless entry keypad to:

- lock or unlock the doors without using a key,
- activate or deactivate the Autolock feature if equipped
- release the liftgate glass,

The keypad can be operated with the factory set 5–digit entry code; this code is located on the owner’s wallet card in the glove box and is available from your authorized dealer. You can also create your own 5–digit personal entry code.

When pressing the controls on the keyless entry keypad, press the middle of the controls to ensure a good activation.

### Programming your own personal entry code

To create your own personal entry code:

1. Enter the factory set code.
2. Within five seconds press the 1 • 2 on the keypad. The doors will lock and then unlock to confirm that the system is in programming mode.

3. Enter your personal 5–digit code. Each number must be entered within five seconds of each other.

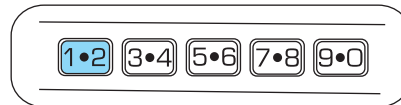

4. Press 1 • 2 on the keypad to assign the Driver 1 setting. The doors will lock and then unlock to confirm that your personal entry code has been programmed.

You can store up to three personal entry codes. The above procedure shows how to set the Driver 1 setting. To assign the additional settings, repeat Steps 1 through 3, then for Step 4, do one of the following:

- Press 3 • 4 to assign the Driver 2 setting.
- Press 5 • 6, 7 • 8, or 9 • 0 to assign the Driver 3 setting.

## Locks and Security

### Tips

- Do not use five numbers in sequential order.
- The factory set code will work even if you have set your own personal code.

### Erasing personal code

1. Enter the factory set 5-digit code.
2. Within five seconds, press the 1 • 2 on the keypad and release.
3. Press and hold the 1 • 2 for two seconds. This must be done within five seconds of completing Step 2.

Your personal code is now erased and only the factory set 5-digit code will work.

### Anti-scan feature

If the wrong code has been entered seven times (35 consecutive button presses), the keypad will go into an anti-scan mode. This mode disables the keypad for one minute and the keypad lamp will flash.

The anti-scan feature will turn off after:

- one minute of keypad inactivity,
- pressing the  control on the remote entry transmitter,
- or the ignition position changes.

### Unlocking and locking the doors and liftgate using keyless entry

**To unlock the driver's door**, enter the factory set 5-digit code or your personal code. Each number must be pressed within five seconds of each other. The interior lamps will illuminate.

**To unlock all doors and liftgate**, press the 3 • 4 control within five seconds of entering the factory set 5-digit code or your personal code.

**To lock all doors and liftgate**, press the 7 • 8 and the 9 • 0 at the same time. **Note:** The driver's door must be closed. You **do not** need to enter the keypad code first.

**To open the liftgate glass**, press the 5 • 6 after entering the factory set 5-digit code or your personal code.

## Locks and Security

### SECURILOCK® PASSIVE ANTI-THEFT SYSTEM

SecuriLock® passive anti-theft system is an engine immobilization system. This system is designed to help prevent the engine from being started unless a **coded integrated keyhead transmitter (IKT) programmed to your vehicle** is used. The use of the wrong type of coded key may lead to a “no-start” condition.

Your vehicle comes with two coded integrated keyhead transmitters; additional coded IKTs may be purchased from your authorized dealer. Standard SecuriLock® keys without remote entry transmitter functionality can also be purchased from your authorized dealer if desired. The authorized dealer can program your spare IKTs to your vehicle or you can program the IKTs yourself. Refer to *Programming spare keys* for instructions on how to program the coded key.

**Note:** The SecuriLock® passive anti-theft system is not compatible with non-Ford aftermarket remote start systems. Use of these systems may result in vehicle starting problems and a loss of security protection.

**Note:** Large metallic objects, electronic devices that are used to purchase gasoline or similar items, or a second coded key on the same key chain may cause vehicle starting issues. You need to prevent these objects from touching the coded IKT while starting the engine. These objects will not cause damage to the coded IKT, but may cause a momentary issue if they are too close to the IKT when starting the engine. If a problem occurs, turn the ignition off, remove all objects on the key chain away from the coded IKT and restart the engine.

**Note: Do not leave a duplicate coded key in the vehicle. Always take your keys and lock all doors when leaving the vehicle.**

## Locks and Security

### Anti-theft indicator

The anti-theft indicator is located in the instrument panel cluster.

- When the ignition is in the off position, the indicator will flash once every two seconds to indicate the SecuriLock® system is functioning as a theft deterrent.
- When the ignition is in the on position, the indicator will glow for three seconds to indicate normal system functionality.



If a problem occurs with the SecuriLock® system, the indicator will flash rapidly or glow steadily when the ignition is in the on position. If this occurs, turn the ignition off then back to on to make sure there was no electronic interference with the programmed key. If the vehicle doesn't start, try to start it with the 2nd programmed key and if successful contact your authorized dealership for key replacement. If the indicator still flashes rapidly or glows steadily, the vehicle will not start, contact your authorized dealer as soon as possible for service.

### Automatic arming

The vehicle is armed immediately after switching the ignition to the off position.

The theft indicator will flash every two seconds to act as a theft deterrent when the vehicle is armed.



### Automatic disarming

The vehicle is disarmed immediately after the ignition is turned to the on position.

The theft indicator will illuminate for three seconds and then go out. If the theft indicator stays on for an extended period of time or flashes rapidly, contact your authorized dealer as soon as possible.

### Key information

Your vehicle is supplied with **two coded keys**. Only a **coded key** will start your vehicle. Spare coded keys can be purchased from your authorized dealer. Your authorized dealer can program your key or you can “do it yourself.” Refer to the *Programming spare keys* section in this chapter.

## Locks and Security

The following items may prevent the vehicle from starting:

- Large metallic objects
- Electronic devices on the key chain that can be used to purchase gasoline or similar items
- A second key on the same key ring as the **coded key**

If any of these items are present, you need to keep these objects from touching the **coded key** while starting the engine. These objects and devices cannot damage the **coded key**, but can cause a momentary “no start” condition if they are too close to the key during engine start. If a problem occurs, turn ignition the off position and restart the engine with all other objects on the key ring held away from the ignition key. Check to make sure the **coded key** is an approved Ford **coded key**.

If your keys are lost or stolen you will need to do the following:

- Use your spare key to start the vehicle, or
- Have your vehicle towed to a authorized dealer or a locksmith. The key codes will need to be erased from your vehicle and new key codes will need to be re-coded.

Replacing coded keys can be very costly and you may want to store an extra programmed key away from the vehicle in a safe place to prevent an unforeseen inconvenience.

The correct **coded key** must be used for your vehicle. The use of the wrong type of **coded key** may lead to a “no start” condition.

**If an unprogrammed key is used in the ignition it will cause a “no start” condition.**

### Programming spare keys

You can program your own integrated keyhead transmitters or standard SecuriLock® coded keys to your vehicle. This procedure will program both the engine immobilizer keycode and the remote entry transmitter portion of the IKT to your vehicle. **Note:** A maximum of eight coded keys can be programmed to your vehicle; only four of these eight can be IKTs with remote entry functionality.

#### Tips:

- Only use integrated keyhead transmitters (IKTs) or standard SecuriLock® keys.
- You must have two previously programmed coded keys (keys that already operate your vehicle’s engine) and the new unprogrammed key(s) readily accessible.

## Locks and Security

- If two previously programmed coded keys are not available, you must take your vehicle to your authorized dealer to have the spare key(s) programmed.

Please read and understand the entire procedure before you begin.

1. Insert the first previously programmed **coded key** into the ignition.

2. Turn the ignition from the 1 (off) position to the 3 (on) position. Keep the ignition in the 3 (on) position for at least three seconds, but no more than 10 seconds.

3. Turn the ignition to the 1 (off) position and remove the first **coded key** from the ignition.

4. After three seconds but within 10 seconds of turning the ignition to the 1 (off) position, insert the second previously **coded key** into the ignition.

5. Turn the ignition from the 1 (off) position to the 3 (on) position. Keep the ignition in the 3 (on) position for at least three seconds, but no more than 10 seconds.

6. Turn the ignition to the 1 (off) position and remove the second previously programmed **coded key** from the ignition.

7. After three seconds but within 20 seconds of turning the ignition to the 1 (off) position and removing the previously programmed **coded key**, insert the new unprogrammed key (new key/valet key) into the ignition.

8. Turn the ignition from the 1 (off) position to the 3 (on) position. Keep the ignition in the 3 (on) position for at least six seconds.

9. Remove the newly programmed **coded key** from the ignition.

If the key has been successfully programmed it will start the vehicle's engine and will operate the remote entry system (if the new key is an integrated keyhead transmitter). The theft indicator light will illuminate for three seconds and then go out to indicate successful programming.

If the key was not successfully programmed, it will not start your vehicle's engine and/or will not operate the remote entry features. The theft indicator light may flash on and off. Wait 20 seconds and you may repeat Steps 1 through 8. If failure repeats, bring your vehicle to your authorized dealer to have the new key(s) programmed.

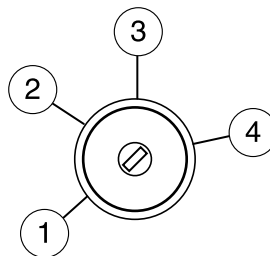

## Locks and Security

To program additional new unprogrammed key(s), wait 20 seconds and then repeat this procedure from Step 1.

**Note:** To program MyKey™ features, refer to *MyKey™* in this chapter.

### PERIMETER ALARM SYSTEM (IF EQUIPPED)

The perimeter anti-theft system will help protect your vehicle from unauthorized entry.

If there is any potential perimeter anti-theft problem with your vehicle, ensure **ALL integrated keyhead transmitters** are brought to the authorized dealer to aid in troubleshooting.

### Arming the system

When armed, this system will respond if unauthorized entry is attempted. When unauthorized entry occurs, the system will flash the turn signal lamps and will sound the horn.

The system is ready to arm whenever the key is in the off position, or is removed from the ignition. Either of the following actions will prearm the alarm system:

- Press the  control on the remote entry transmitter portion of your integrated keyhead transmitter.

When you press the lock control twice within three seconds on the remote entry transmitter portion of your IKT, the horn will chirp once to let you know that all doors, the hood and the liftgate are closed. If any of these are not closed, the horn will chirp twice to warn you that a door, the hood or the liftgate is still open.

- Press the driver or passenger interior door lock control while the door is open, then close the door.

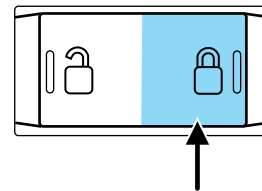

- Press the 7 • 8 and 9 • 0 controls on the keyless entry pad at the same time to lock the doors (driver's door must be closed).

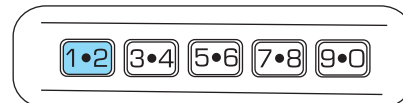

There is a 20 second countdown when any of the above actions occur before the vehicle becomes armed.



## Locks and Security

Each door, the hood, and the liftgate is armed individually, and if any are open, they must be closed before the open entry point (door, hood, or liftgate) can enter the 20 second countdown.

The turn signal lamps will flash once when all doors, the hood and the liftgate are closed indicating the vehicle is locked and entering the 20 second countdown.

### **Disarming the system**

You can disarm the system by any of the following actions:

- Unlock the doors by using the remote entry transmitter portion of your Integrated Keyhead Transmitter.
- Unlock the doors by using your keyless entry pad.
- Turn ignition to the on position with a valid programmed SecuriLock™ key or Integrated Keyhead Transmitter (IKT).
- Press the panic control on the remote entry transmitter portion of your IKT. This will only shut off the horn and turn lamps when the alarm is sounding. The alarm system will still be armed.
- If using a key in the driver's door to unlock the vehicle, a chime will sound when you open the door and you will have 12 seconds to disarm the alarm system using any of the actions above, otherwise the alarm will trigger.

Pressing the power door unlock control within the 20-second prearmed mode will return the vehicle to a disarmed state.

### **Triggering the anti-theft system**

The armed system will be triggered if:

- Any door, the hood or the liftgate is opened without using the keypad or the remote entry transmitter portion of your IKT.
- The ignition is turned to the on position with an invalid unprogrammed SecuriLock® key or IKT.

## Seating and Safety Restraints

### SEATING

#### Adjustable head restraints

Your vehicle is equipped with front row outboard head restraints that are vertically adjustable.

 **WARNING:** To minimize the risk of neck injury in the event of a crash, the driver and passenger occupants should not sit in and/or operate the vehicle, until the head restraint is placed in its proper position. The driver should never adjust the head restraint while the vehicle is in motion.

The adjustable head restraints consist of :

- a trimmed energy absorbing foam and structure (1),
- two steel stems (2),
- a guide sleeve adjust/release button (3),
- and a guide sleeve unlock/remove button (4).

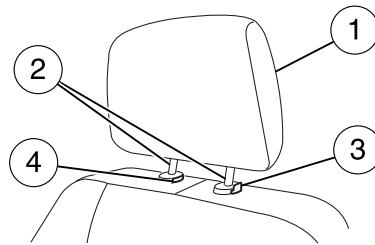

To adjust the head restraint, do the following:

1. Adjust the seatback to an upright driving/riding position.
2. Raise the head restraint by pulling up on the head restraint.

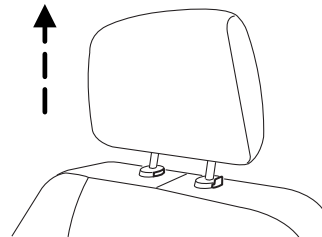

## Seating and Safety Restraints

3. Lower the head restraint by pressing and holding the guide sleeve adjust/release button and pushing down on the head restraint.

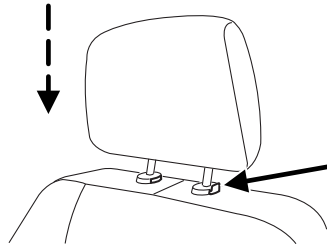

Properly adjust the head restraint so that the top of the head restraint is even with the top of your head and positioned as close as possible to the back of your head. For occupants of extremely tall stature, adjust the head restraint to its full up position.



**WARNING:** The adjustable head restraint is a safety device. Whenever possible it should be installed and properly adjusted when the seat is occupied.

To remove the adjustable head restraint, do the following:

1. Pull up the head restraint until it reaches the highest adjustment position.

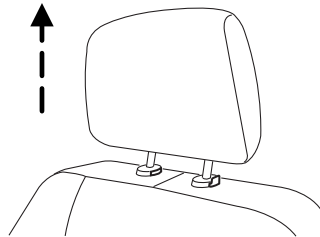

## Seating and Safety Restraints

2. Simultaneously press and hold both the adjust/release button and the unlock/remove button, then pull up on the head restraint.

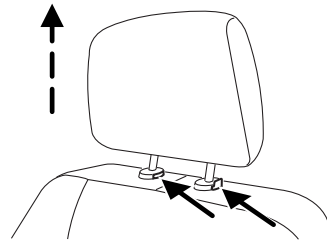

To reinstall the adjustable head restraint, do the following:

1. Insert the two stems into the guide sleeve collars.
2. Push the head restraint down until it locks.

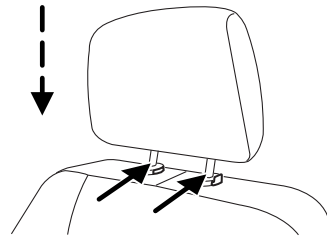

Properly adjust the head restraint so that the top of the head restraint is even with the top of your head and positioned as close as possible to the back of your head. For occupants of extremely tall stature, adjust the head restraint to its full up position.



**WARNING:** To minimize the risk of neck injury in the event of a crash, head restraints must be installed properly.

### Adjusting the front manual seat (if equipped)



**WARNING:** Never adjust the driver's seat or seatback when the vehicle is moving.



**WARNING:** Do not pile cargo higher than the seatbacks to reduce the risk of injuring people in a collision or sudden stop.

## Seating and Safety Restraints

Lift handle to move seat forward or backward.

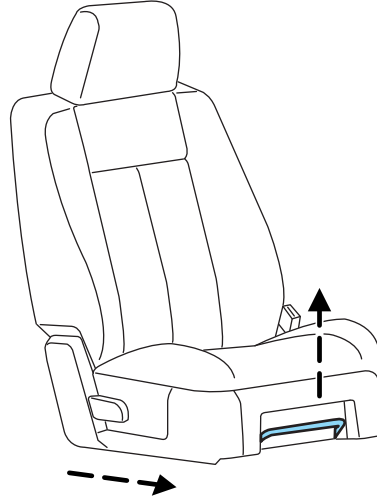

### Manual seat recliner (if equipped)



**WARNING:** Always drive and ride with your seatback upright and the lap belt snug and low across the hips.



**WARNING:** Reclining the seatback can cause an occupant to slide under the seat's safety belt, resulting in severe personal injuries in the event of a collision.

Pull the seatback handle up to recline the seat.

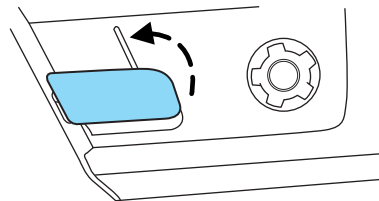

## Seating and Safety Restraints

### Using the armrest (if equipped)

Push the release control to move the armrest up or down.

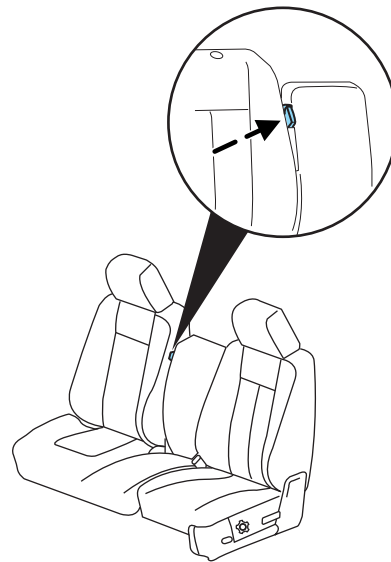

### Using the manual lumbar support (if equipped)

The lumbar support control is located on the outboard side of the seat.

Turn the lumbar support control clockwise for more support.

Turn the lumbar support control counter-clockwise for less support.

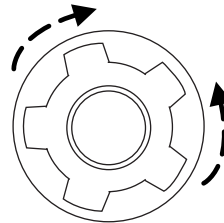

## Seating and Safety Restraints

### Using the power lumbar support (if equipped)

The power lumbar control is located on the outboard side of the seat.

Press the forward side of the control for additional support.

Press the rear side of the control to reduce support.

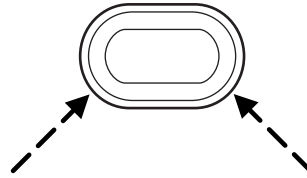

### Adjusting the front power seat



**WARNING:** Never adjust the driver's seat or seatback when the vehicle is moving.



**WARNING:** Do not pile cargo higher than the seatbacks to avoid injuring people in a collision or sudden stop.



**WARNING:** Always drive and ride with your seatback upright and the lap belt snug and low across the hips.



**WARNING:** Reclining the seatback can cause an occupant to slide under the seat's safety belt, resulting in severe personal injuries in the event of a collision.

The control is located on the outboard side of the seat cushion.

Move the switch in the direction of the arrows to raise or lower the front portion of the seat cushion.

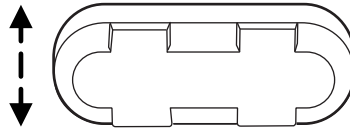

## Seating and Safety Restraints

Move the switch in the direction of the arrows to raise or lower the rear portion of the seat cushion.

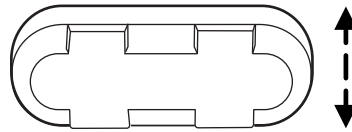

Press the switch in the direction of the arrows to move the seat forward, backward, up or down.

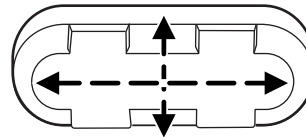

Press the control to recline the seatback forward or rearward.

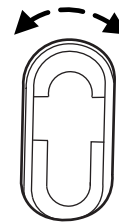

**Note:** On vehicles with memory seats, to prevent damage to the seat, the power seats are designed to set a stopping position just short of the end of the seat track. If the seat encounters an object while moving forward or backward, a new stopping position will be set. To reset the seat to its normal stopping position:

- After encountering the new stopping position, press the power seat control again to override.
- Continue pressing the control until it reaches the end of the seat track.
- Continue pressing the control for approximately two seconds. You will feel the seat bounce back slightly.



## Seating and Safety Restraints

### Memory seat/power mirrors/adjustable pedals (if equipped)

This system allows automatic positioning of the driver seat, power mirrors and adjustable pedals to two programmable positions.

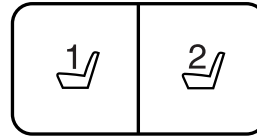

The memory seat control is located on the driver's seat.

- To program position 1, move the driver seat and mirrors to the desired position using the associated controls. Press and hold button 1 for at least two seconds. A chime will sound confirming that a memory position has been set.
- To program position 2, repeat the previous procedure using button 2.

A memory seat position may be programmed at any time.

To program the memory feature to a remote entry transmitter, refer to *Remote entry system* in the *Locks and Security* chapter.

A programmed memory position can be recalled:

- in any gearshift position if the ignition is **not** on.
- only in P (Park) or N (Neutral) if the ignition is on.

The memory positions are also recalled when you press your remote entry transmitter  (unlock) control (if the transmitter is programmed to a memory position) or, when you enter a valid personal entry code that is programmed to a memory position. The mirrors will move to the programmed position and the seat will move to the easy entry position. The seat will move to the final position when the key is in the ignition (if easy entry feature is enabled).

### Climate controlled seats (if equipped)

**Note:** It is recommended for optimal performance that the vehicle air conditioning system be run in the same mode (either heating or cooling) as the climate control seat system. During start up of the climate control seat system, a slight difference in seat surface temperature may be perceived between the seat cushion and seat back until the cabin and seat temperatures stabilize. If the vehicle air conditioning system is run in floor mode, the effect may be more pronounced. Switching between seat heat and seat cool modes in alternate succession will delay the time it takes for the seat temperatures (back and cushion) to stabilize.

The controls for the climate controlled seats are located on the dual electronic automatic temperature control (DEATC) system.

## Seating and Safety Restraints

### Heated seats

 **WARNING:** Persons who are unable to feel pain to the skin because of advanced age, chronic illness, diabetes, spinal cord injury, medication, alcohol use, exhaustion, or other physical conditions, must exercise care when using the seat heater. The seat heater may cause burns even at low temperatures, especially if used for long periods of time. Do not place anything on the seat that insulates against heat, such as a blanket or cushion, because this may cause the seat heater to overheat. Do not puncture the seat with pins, needles, or other pointed objects because this may damage the heating element which may cause the seat heater to overheat. An overheated seat may cause serious personal injury.

**Note:** Do not do the following:

- Place heavy objects on the seat
- Operate the seat heater if water or any other liquid is spilled on the seat. Allow the seat to dry thoroughly.

The heated seats will only function when the engine is running.

To operate the heated seats:

Press the heated seat symbol to cycle through the various heat settings and off. Warmer settings are indicated by more indicator lights.



### Cooled seats

The cooled seats will only function when the engine is running.

To operate the cooled seats:

Press the cooled seat symbol to cycle through the various cooling settings and off. Cooler settings are indicated by more indicator lights.



If the engine falls below 350 RPMs while the cooled seats are on, the feature will turn itself off and will need to be reactivated.

## Seating and Safety Restraints

### ***Climate controlled seats air filter replacement (if equipped)***

The climate controlled seat system includes air filters that must be replaced periodically. Refer to the *scheduled maintenance information* for more information.

- There is a filter located under each front seat.

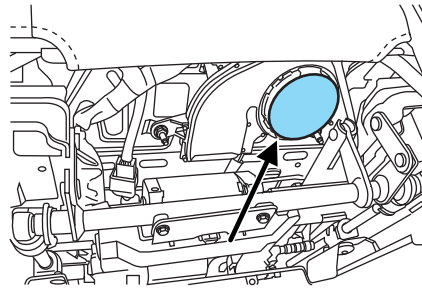

- The filter can be accessed from the second row seat. Move the front seats all the way forward and up to ease access.

To remove an air filter:

1. Remove key from ignition.
2. Press up on the outside rigid edge of the filter and rotate toward the front of the vehicle once tabs are released.

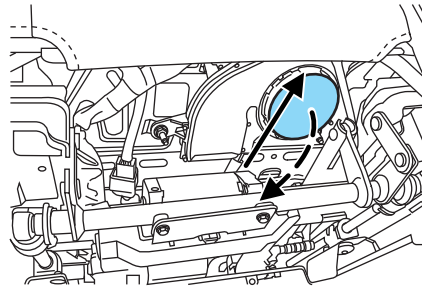

3. Remove filter.

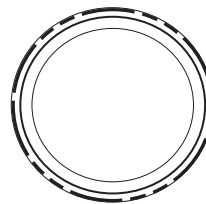

## Seating and Safety Restraints

To install a filter:

- First, position the filter in its housing making sure that the far forward end is all the way up in the housing. Then push in on the center of the outside edge of the filter and rotate up into the housing until it clips into position.

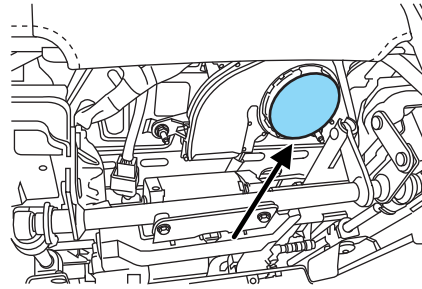

### REAR SEATS

#### Folding down the 2nd row 40% seat system

 **WARNING:** Use caution when folding the seatback to the flat back position as the system will move forward when you lift the release handle.

Ensure that the head restraint is in the down position and no objects such as books, purses or briefcases are on the floor in front of the second row seats before folding them down.

Move the front passenger seat forward so that the second row seat headrest clears the front seat.

For assistance, refer to the label located on the side of the seat cushion.

1. Lower the head restraints by pulling on the strap.

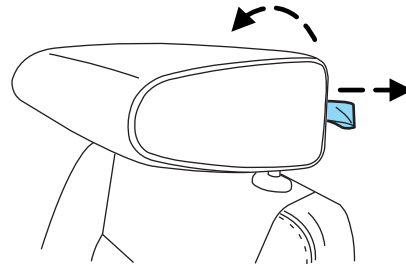

## Seating and Safety Restraints

2. Locate handle on the side of the seat cushion by the door.
3. Pull up on the handle and push the seatback forward toward the front of the vehicle.

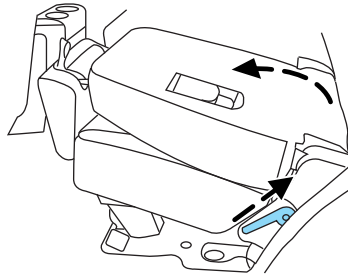

To return the seat to the upright position:

1. Lift the seatback toward the rear of the vehicle.
2. Rotate the seatback until you hear a click, locking it in the upright position.

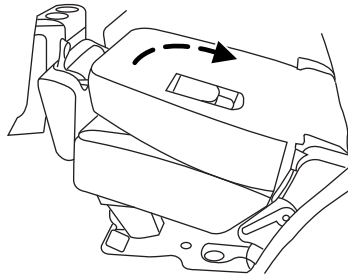

3. Lift up on the head restraint until it locks into its original position.

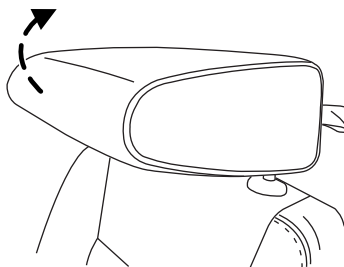

**WARNING:** Before returning the seatback to its original position, make sure that cargo or any objects are not trapped behind the seatback. After returning the seatback to its original position, pull on the seatback to ensure that it has fully latched. An unlatched seat may become dangerous in the event of a sudden stop or collision.

## Seating and Safety Restraints

### **Placing the 2nd row outboard 40% seats in cargo mode**

 **WARNING:** Use caution when folding the seatback to the flat back position as the system will move forward when you lift the release handle.

The 2nd row seats can be placed in a kneel down load floor position to allow more cargo space.

 **WARNING:** Always return the seat from the kneel position prior to raising the seatback. Failure to do so could result in personal injury.

To place the seats in the cargo mode:

1. Fold down the 2nd row seat.
2. Pull the cargo mode lever up to release the seat into a kneel down load floor position. A moderate force may be required to move the seat forward and down.

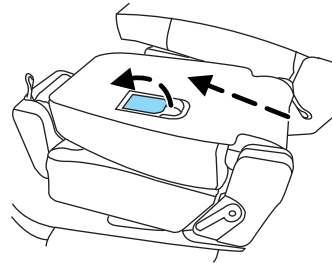

## Seating and Safety Restraints

### Returning to the upright position from full lowered load floor position

The seatback cannot be returned to the upright position until the seat is returned from the kneel down position. To return the seat to the upright position:

1. Push the seat rearward until the latch is engaged.
2. Return the seatback to the upright position.

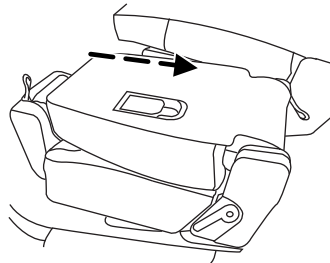

### Adjusting the 2nd row outboard 40% seat for E-Z Entry

The E-Z entry seat allows for easier entry and exit to and from the 3rd row seat.

To enter the 3rd row seat:

1. Fold down the 2nd row seat and release the handle.
2. Pull the handle up again until the seat releases from the floor.
3. Push the seat upward and fold it away from the third row.

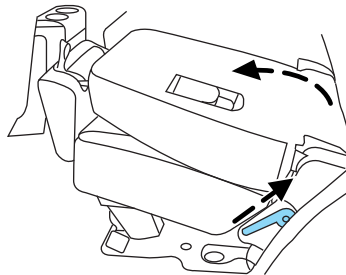

**WARNING:** Always latch the vehicle seat to the floor, whether the seat is occupied or empty. If not latched, the seat may cause injury during a sudden stop.

## Seating and Safety Restraints

To return the seat to a seating position:

1. Push the seat down and latch to the floor with a moderate amount of effort and speed.
2. Make sure the seat is latched to the floor.
3. Bring the seat back to an upright position. The seatback should lock into position.

**Note:** If the seat back will not return to the upright position, tumble the seat again and re-latch it to the floor. Be sure that cargo or other objects are not trapped underneath the seatback.

**Note:** If a squeak is heard from the latch area, the latch striker pin should be wiped clean of dust or debris.

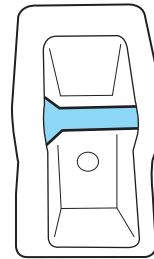
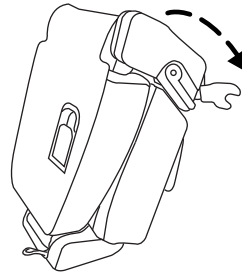

**WARNING:** Before returning the seatback to its original position, make sure that cargo or any objects are not trapped behind the seatback. After returning the seatback to its original position, pull on the seatback to ensure that it has fully latched. An unlatched seat may become dangerous in the event of a sudden stop or collision.



## Seating and Safety Restraints

### Exiting the 3rd row

1. Pull the strap located at the bottom outboard of the seat back to release the seat from the floor, and rotate the seat up towards the front seat.
2. Follow the directions above to return the seat from the E-Z entry and to the upright position.

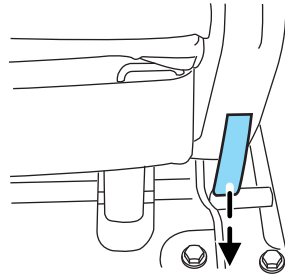

### Reclining the 2nd row outboard 40% seatback

Locate the release handle on the outboard side of the seat cushion and lift gently to allow the seatback to be adjusted to the desired location.

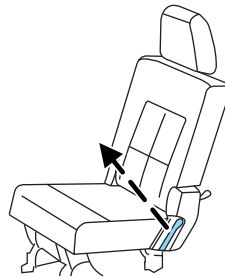

**WARNING:** Reclining the seatback can cause an occupant to slide under the seat's safety belt, resulting in severe personal injuries in the event of a collision.

### Folding the 2nd row center 20% seat system (if equipped)

1. Locate the release handle located in the upper left seat back, and pull the handle to release the folding seat latch.

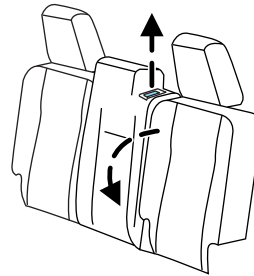

## Seating and Safety Restraints

 **WARNING:** To prevent possible damage to the seat or safety belts, ensure that the safety belts are not buckled when moving the seat to the load floor position.

2. With the latch released the seatback can be lowered into the load floor position.

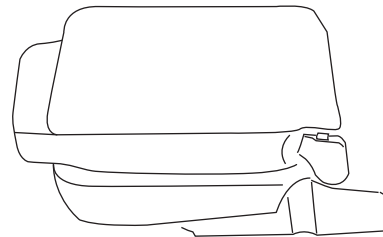

3. To return the seat to the upright position, lift the seatback until the latch is fully engaged.

 **WARNING:** Before returning the seatback to its original position, make sure that cargo or any objects are not trapped underneath the seatback. After returning the seatback to its original position, pull on the seatback to ensure that it has fully latched. An unlatched seat may become dangerous in the event of a sudden stop or collision.

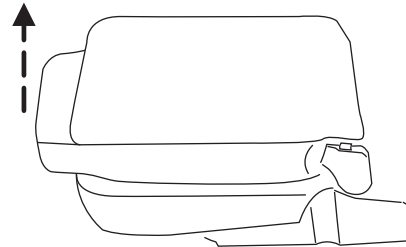

## Seating and Safety Restraints

### **Adjusting the 2nd row center 20% seat (if equipped)**

Lift the handle to move the seat forward or backward.

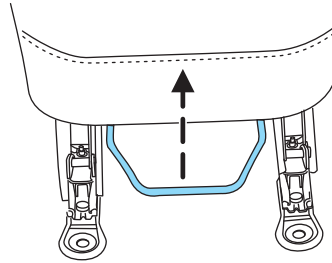

**Note:** This seat can be moved forward to keep a child in a child restraint close to the front seat occupants. The seat should be moved to the full rearward position when it is occupied by older children or adults, including children in booster seats.

### **Rear heated seats (if equipped)**



**WARNING:** Persons who are unable to feel pain to the skin because of advanced age, chronic illness, diabetes, spinal cord injury, medication, alcohol use, exhaustion, or other physical conditions, must exercise care when using the seat heater. The seat heater may cause burns even at low temperatures, especially if used for long periods of time. Do not place anything on the seat that insulates against heat, such as a blanket or cushion, because this may cause the seat heater to overheat. Do not puncture the seat with pins, needles, or other pointed objects because this may damage the heating element which may cause the seat heater to overheat. An overheated seat may cause serious personal injury.

**Note:** Do not do the following:

- Place heavy objects on the seat
- Operate the seat heater if water or any other liquid is spilled on the seat. Allow the seat to dry thoroughly.

The rear seat heat controls are located on the rear of the center console.

## Seating and Safety Restraints

The heated seats only operate when the ignition is on. To operate the heated seats:

- Press the indicated side of the control for maximum heat.
- Press again to deactivate.
  
- Press the indicated side of the control for minimum heat.
- Press again to deactivate.

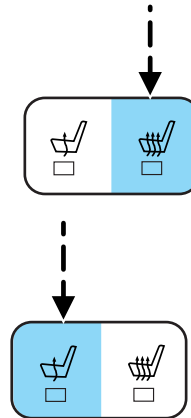

The heated seat module resets at every ignition run cycle. While the ignition is in the on position, activating the high or low heated seat switch enables heating mode. When activated, they will turn off automatically when the engine is turned off.

The indicator light will illuminate when the heated seats have been activated.

### 3rd row seats

Ensure that no objects such as books, purses or briefcases are on the floor in front of the third row seats or on the seat cushion before lowering them. Ensure that the head restraints are lowered. Ensure that the second row seats are not reclined.

## Seating and Safety Restraints

### Folding down the 3rd row seats to the load floor

 **WARNING:** To prevent possible damage to the seat or safety belts, ensure that the safety belts are not buckled when moving the seat to the load floor position.

Before folding the third row seats, fold the head restraints down by pulling on the strap located at the bottom of the restraint.

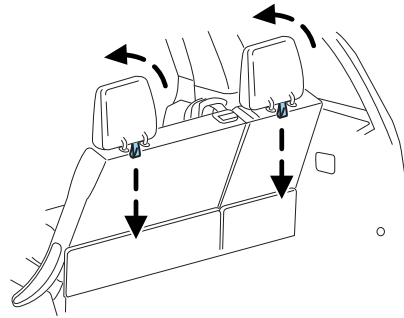

Pull up on the handle located behind the seatback while pushing the seatback forward and down into the seat cushion.

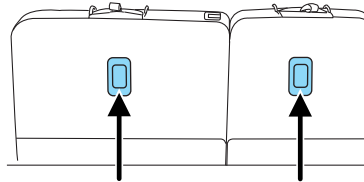

To return the seatback to its original position lift the seatback until it latches into place.

 **WARNING:** Before returning the seatback to its original position, make sure that cargo or any objects are not trapped behind the seatback. After returning the seatback to its original position, pull on the seatback to ensure that it has fully latched. An unlatched seat may become dangerous in the event of a sudden stop or collision.

## Seating and Safety Restraints

### *Third row power folding seat (if equipped)*

**Note:** Be sure that the head restraints are folded down before powering the 3rd row seat down. The control buttons are located on the right-hand rear quarter trim panel (accessible from the liftgate area).

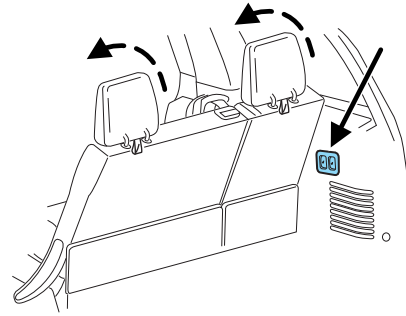

Press the bottom portion of the control button to lower the desired seatback.

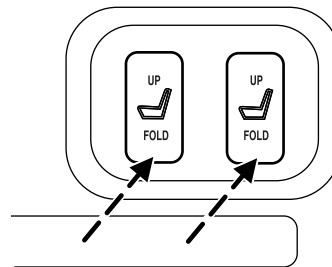

Press the top of the control button to return the seatback to its original position.

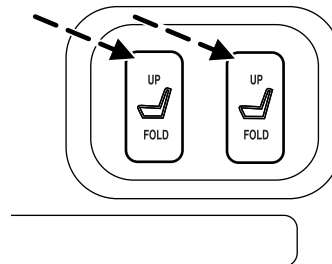

**The power fold down seats will operate for 10 minutes after the ignition switch is in off. The transmission must be in P (Park), and the liftgate, or liftgate glass must be open. Similar to the battery saver feature, the power 3rd row seat will be disabled 10 minutes after turning the vehicle off. If the power 3rd row seat is disabled after 10 minutes, the seat can be enabled by opening any door, pressing the unlock button on the key fob, pressing any keyless entry keypad button, or turning the ignition key.**

## Seating and Safety Restraints

### SAFETY RESTRAINTS

The restraint system provides an improved overall level of frontal crash protection to front seat occupants and is designed to help further reduce the risk of airbag-related injuries. The system is able to analyze different occupant conditions and crash severity before activating the appropriate safety devices to help better protect a range of occupants in a variety of frontal crash situations.

Your vehicle's restraint system consists of:

- Driver and passenger dual-stage airbag supplemental restraints.
- Front safety belts with pretensioners, energy management retractors, and safety belt usage sensors.
- Driver's seat position sensor.
- Front crash severity sensor.
- Restraints Control Module (RCM).
- Restraint system warning light and back-up tone.
- The electrical wiring for the airbags, crash sensor(s), safety belt pretensioners, front safety belt usage sensors, driver seat position sensor, and indicator lights.

#### ***How does the restraint system work?***

The restraint system can adapt the deployment strategy of your vehicle's safety devices according to crash severity and occupant conditions. A collection of crash and occupant sensors provides information to the Restraints Control Module (RCM). During a crash, the RCM may activate the safety belt pretensioners and/or either one or both stages of the dual-stage airbag supplemental restraints based on crash severity and occupant conditions.

The fact that the pretensioners or airbags did not activate for both front seat occupants in a collision does not mean that something is wrong with the system. Rather, it means the restraint system determined the accident conditions (crash severity, belt usage, etc.) were not appropriate to activate these safety devices. Front airbags are designed to activate only in frontal and near-frontal collisions, not rollovers, side-impacts, or rear-impacts unless the collision causes sufficient longitudinal deceleration.

## Seating and Safety Restraints

### ***Driver and passenger dual-stage airbag supplemental restraints***

The dual-stage airbags offer the capability to tailor the level of airbag inflation energy. A lower, less forceful energy level is provided for more common, moderate-severity impacts. A higher energy level is used for the most severe impacts. Refer to *Airbag supplemental restraints (SRS)* section in this chapter.

### ***Front crash severity sensor***

The front crash severity sensor enhances the ability to detect the severity of an impact. Positioned up front, it provides valuable information early in the crash event on the severity of the impact. This allows your restraint system to distinguish between different levels of crash severity and modify the deployment strategy of the dual-stage airbags and safety belt pretensioners.

### ***Driver's seat position sensor***

The driver's seat position sensor allows your restraint system to tailor the deployment level of the driver dual-stage airbag based on seat position. The system is designed to help protect smaller drivers sitting close to the driver airbag by providing a lower airbag output level.

### ***Front safety belt usage sensors***

The front safety belt usage sensors detect whether or not the driver and front outboard passenger safety belts are fastened. This information allows your restraint system to tailor the airbag deployment and safety belt pretensioner activation depending upon safety belt usage. Refer to *Safety restraints* section in this chapter.

### ***Front safety belt pretensioners***

The safety belt pretensioners at the front outboard seating positions are designed to tighten the safety belts firmly against the occupant's body during frontal collisions, and in side collisions and rollovers. This helps increase the effectiveness of the safety belts. In frontal collisions, the safety belt pretensioners can be activated alone or, if the collision is of sufficient severity, together with the front airbags.

### ***Front safety belt energy management retractors***

The front outboard safety belt energy management retractors allow webbing to be pulled out of the retractor in a gradual and controlled manner in response to the occupant's forward momentum. This helps reduce the risk of force-related injuries to the occupant's chest by limiting the load on the occupant. Refer to *Safety restraints* section in this chapter.



## Seating and Safety Restraints

### ***Determining if the restraint system is operational***

The restraint system uses a warning light in the instrument cluster or a back-up tone to indicate the condition of the system. Refer to the *Warning lights and chimes* section in the *Instrument Cluster* chapter. Routine maintenance of the restraint system is not required.

The Restraints Control Module (RCM) monitors its own internal circuits and the circuits for the airbag supplemental restraints, crash sensor(s), safety belt pretensioners, front safety belt buckle sensors, and the driver seat position sensor. In addition, the RCM also monitors the restraints warning light in the instrument cluster. A difficulty with the system is indicated by one or more of the following:

- The warning light will either flash or stay lit.
- The warning light will not illuminate immediately after the ignition is turned on.
- A series of five beeps will be heard. The tone pattern will repeat periodically until the problem and warning light are repaired.

If any of these things happen, even intermittently, have the restraint system serviced at an authorized dealer immediately. Unless serviced, the system may not function properly in the event of a collision.

### **Safety restraints precautions**



**WARNING:** Always drive and ride with your seatback upright and the lap belt snug and low across the hips.



**WARNING:** To reduce the risk of injury, make sure children sit in a rear seating position where they can be properly restrained.





**WARNING:** Never let a passenger hold a child on his or her lap while the vehicle is moving. The passenger cannot protect the child from injury in a collision.





**WARNING:** All occupants of the vehicle, including the driver, should always properly wear their safety belts, even when an airbag supplemental restraint system (SRS) is provided.

## Seating and Safety Restraints

 **WARNING:** It is extremely dangerous to ride in a cargo area, inside or outside of a vehicle. In a collision, people riding in these areas are more likely to be seriously injured or killed. Do not allow people to ride in any area of your vehicle that is not equipped with seats and safety belts. Be sure everyone in your vehicle is in a seat and using a safety belt properly.

 **WARNING:** In a rollover crash, an unbelted person is significantly more likely to die than a person wearing a safety belt.

 **WARNING:** Each seating position in your vehicle has a specific safety belt assembly which is made up of one buckle and one tongue that are designed to be used as a pair. 1) Use the shoulder belt on the outside shoulder only. Never wear the shoulder belt under the arm. 2) Never swing the safety belt around your neck over the inside shoulder. 3) Never use a single belt for more than one person.

 **WARNING:** When possible, all children 12 years old and under should be properly restrained in a rear seating position.

 **WARNING:** Safety belts and seats can become hot in a vehicle that has been closed up in sunny weather; they could burn a small child. Check seat covers and buckles before you place a child anywhere near them.

 **WARNING:** Front and rear seat occupants, including pregnant women, should wear safety belts for optimum protection in an accident.

## Seating and Safety Restraints

### Combination lap and shoulder belts

1. Insert the belt tongue into the proper buckle (the buckle closest to the direction the tongue is coming from) until you hear a snap and feel it latch. Make sure the tongue is securely fastened in the buckle.

- Front and rear seats

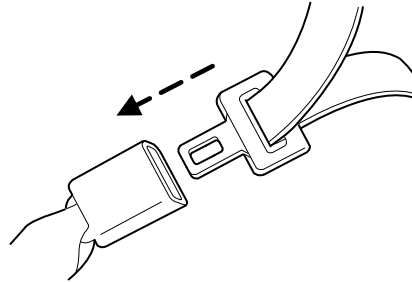

2. To unfasten, push the release button and remove the tongue from the buckle.

- Front and rear seats

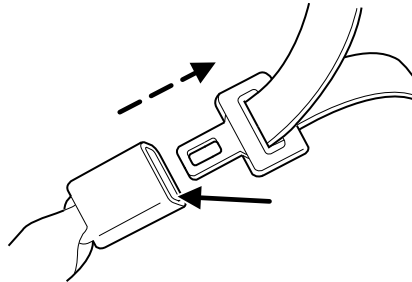

### Restraint of pregnant women



**WARNING:** Always ride and drive with your seatback upright and the safety belt properly fastened. The lap portion of the safety belt should fit snug and be positioned low across the hips. The shoulder portion of the safety belt should be positioned across the chest. Pregnant women should also follow this practice. See figure below.

## Seating and Safety Restraints

Pregnant women should always wear their safety belt. The lap belt portion of a combination lap and shoulder belt should be positioned low across the hips below the belly and worn as tight as comfort will allow. The shoulder belt should be positioned to cross the middle of the shoulder and the center of the chest.



### Safety belt locking modes

All safety restraints in the vehicle are combination lap and shoulder belts. The driver safety belt has the first locking mode and the front outboard passenger and rear seat safety belts have both types of locking modes described as follows:

#### Vehicle sensitive mode

This is the normal retractor mode, which allows free shoulder belt length adjustment to your movements and locking in response to vehicle movement. For example, if the driver brakes suddenly or turns a corner sharply, or the vehicle receives an impact of approximately 5 mph (8 km/h) or more, the combination safety belts will lock to help reduce forward movement of the driver and passengers.

In addition, the retractor is designed to lock if the webbing is pulled out too quickly. If this occurs, let the belt retract slightly and pull webbing out again in a slow and controlled manner.

#### Automatic locking mode

In this mode, the shoulder belt is automatically pre-locked. The belt will still retract to remove any slack in the shoulder belt. The automatic locking mode is not available on the driver safety belt.

#### *When to use the automatic locking mode*

This mode should be used **any time** a child safety seat, except a booster, is installed in passenger front or rear seating positions. Children 12 years old and under should be properly restrained in a rear seating position whenever possible. Refer to *Safety restraints for children* or *Safety seats for children* later in this chapter.

## Seating and Safety Restraints

### ***How to use the automatic locking mode***

- Buckle the combination lap and shoulder belt.

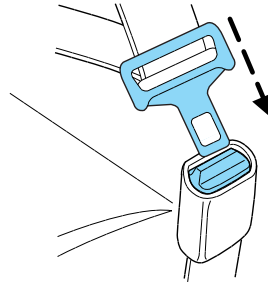

- Grasp the shoulder portion and pull downward until the entire belt is pulled out.



- Allow the belt to retract. As the belt retracts, you will hear a clicking sound. This indicates the safety belt is now in the automatic locking mode.

### **How to disengage the automatic locking mode**

Disconnect the combination lap/shoulder belt and allow it to retract completely to disengage the automatic locking mode and activate the vehicle sensitive (emergency) locking mode.



**WARNING:** After any vehicle collision, the safety belt system at all passenger seating positions must be checked by an authorized dealer to verify that the “automatic locking retractor” feature for child seats is still functioning properly. In addition, all safety belts should be checked for proper function.

## Seating and Safety Restraints



**WARNING:** BELT AND RETRACTOR ASSEMBLY MUST BE REPLACED if the safety belt assembly “automatic locking retractor” feature or any other safety belt function is not operating properly when checked by an authorized dealer. Failure to replace the belt and retractor assembly could increase the risk of injury in collisions.

### Safety belt pretensioner

Your vehicle is equipped with safety belt pretensioners at the driver and right front passenger seating positions.

The safety belt pretensioner removes some slack from the safety belt system at the start of a crash. The safety belt pretensioner uses the same crash sensor system as the front airbags and Safety Canopy® System. When the safety belt pretensioner deploys, the lap and shoulder belt are tightened.

When the Safety Canopy® System and/or the front airbags are activated, the safety belt pretensioners for the driver and right front passenger seating positions will be activated when the respective seatbelt is properly buckled.



**WARNING:** The driver and the right front passenger safety belt system (including retractors, buckles and height adjusters) must be replaced if the vehicle is involved in a collision that results in deployment of front airbags or Safety Canopy® System and safety belt pretensioners.

Refer to the *Child restraints and safety belt maintenance* section in this chapter.

## Seating and Safety Restraints

### Safety belt height adjustment

Your vehicle has safety belt height adjustments for the driver and right front passenger. Adjust the height of the shoulder belt so the belt rests across the middle of your shoulder.

To lower the shoulder belt height, squeeze the side release buttons with your thumb and finger and slide the height adjuster down. To raise the height of the shoulder belt, squeeze the side release buttons and slide the height adjuster up. Pull down on the height adjuster to make sure it is locked in place.

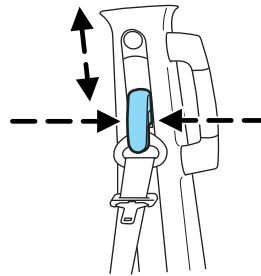

**WARNING:** Position the safety belt height adjusters so that the belt rests across the middle of your shoulder. Failure to adjust the safety belt properly could reduce the effectiveness of the seat belt and increase the risk of injury in a collision.

### Second row comfort guide

The second row outboard lap/shoulder belt is equipped with a belt comfort guide. This guide is attached to the quarter trim panel and is used to adjust the comfort of the shoulder belt for smaller occupants in the outboard second row seats.

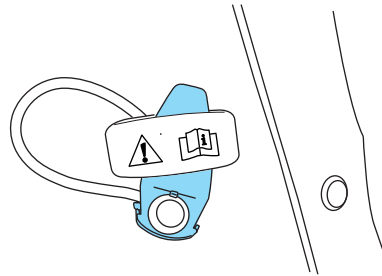

## Seating and Safety Restraints

To adjust the comfort guide:

1. Slip the shoulder belt into the belt guide. (The portion of the belt between the latch tongue and the D-ring, not the portion where the belt exits from the quarter trim panel.)
2. Slide the guide up or down along the webbing so that the belt is centered on the occupant's shoulder.

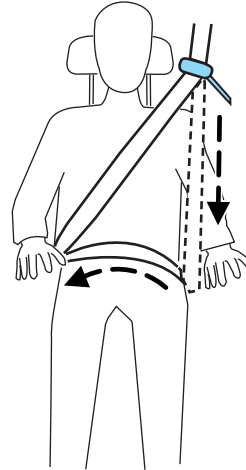

**!** **WARNING:** Position the safety belt comfort guide so that the belt rests across the middle of your shoulder. Failure to adjust the safety belt properly could reduce the effectiveness of the safety belt and increase the risk of injury in a collision.

### Safety belt extension assembly

If the safety belt is too short when fully extended, there is an 8 inch (20 cm) safety belt extension assembly that can be added (part number 611C22). This assembly can be obtained from an authorized dealer.

Use only extensions manufactured by the same supplier as the safety belt. Manufacturer identification is located at the end of the webbing on the label. Also, use the safety belt extension only if the safety belt is too short for you when fully extended.

**!** **WARNING:** Do not use extensions to change the fit of the shoulder belt across the torso.



## Seating and Safety Restraints

### Safety belt warning light and indicator chime

The safety belt warning light illuminates in the instrument cluster and a chime sounds to remind the occupants to fasten their safety belts.

#### Conditions of operation

If...	Then...
The driver safety belt is not buckled before the ignition switch is turned to the on position...	The safety belt warning light illuminates 1-2 minutes and the warning chime sounds 4-8 seconds.
The driver safety belt is buckled while the indicator light is illuminated and the warning chime is sounding...	The safety belt warning light and warning chime turn off.
The driver safety belt is buckled before the ignition switch is turned to the on position...	The safety belt warning light and indicator chime remain off.

### Belt-Minder®

The Belt-Minder® feature is a supplemental warning to the safety belt warning function. This feature provides additional reminders to the driver that the driver's safety belt is unbuckled by intermittently sounding a chime and illuminating the safety belt warning lamp in the instrument cluster.

When the Belt-Minder® feature is activated, the safety belt warning light illuminates and the warning chime sounds for 6 seconds every 30 seconds, repeating for approximately 5 minutes or until the safety belts are buckled.

**Note:** If you are using MyKey™, the Belt-Minder® warning will not expire. Refer to *MyKey™* in the *Locks and security* chapter.

The Belt-Minder® feature uses two different warning chimes. During the first minute of activation, the warning chime will sound once every second. The remaining warning chimes will sound twice every second while the system is activated.

## Seating and Safety Restraints

If...	Then...
The driver's safety belt is not buckled approximately five seconds after the safety belt warning light has turned off...	The Belt-Minder® feature is activated - the safety belt warning light illuminates and the warning chime sounds for six seconds every 30 seconds, repeating for approximately five minutes or until safety belt is buckled.
The driver's safety belt is buckled while the safety belt indicator light is illuminated and the safety belt warning chime is sounding...	The Belt-Minder® feature will not activate.
The driver's safety belt is buckled before the ignition switch is turned to the on position...	The Belt-Minder® feature will not activate.

The purpose of the Belt-Minder® is to remind occasional wearers to wear safety belts all of the time.

The following are reasons most often given for not wearing safety belts: (All statistics based on U.S. data)

Reasons given...	Consider...
"Crashes are rare events"	<b>36700 crashes occur every day.</b> The more we drive, the more we are exposed to "rare" events, even for good drivers. <i>1 in 4 of us will be seriously injured in a crash during our lifetime.</i>
"I'm not going far"	<b>3 of 4</b> fatal crashes occur within <b>25</b> miles of home.
"Belts are uncomfortable"	We design our safety belts to enhance comfort. If you are uncomfortable - try different positions for the safety belt upper anchorage and seatback which should be as upright as possible; this can improve comfort.

## Seating and Safety Restraints

Reasons given...	Consider...
“I was in a hurry”	<b>Prime time for an accident.</b> Belt-Minder® reminds us to take a few seconds to buckle up.
“Safety belts don’t work”	<b>Safety belts</b> , when used properly, <b>reduce risk of death</b> to front seat occupants by <b>45% in cars</b> , and by <b>60% in light trucks</b> .
“Traffic is light”	<b>Nearly 1 of 2 deaths occur in single-vehicle crashes</b> , many when no other vehicles are around.
“Belts wrinkle my clothes”	Possibly, but a serious crash can do much more than wrinkle your clothes, particularly if you are unbelted.
“The people I’m with don’t wear belts”	Set the example, teen deaths occur 4 times more often in vehicles with TWO or MORE people. Children and younger brothers/sisters imitate behavior they see.
“I have an airbag”	Airbags offer greater protection when used with safety belts. Frontal airbags are not designed to inflate in rear and side crashes or rollovers.
“I’d rather be thrown clear”	Not a good idea. <b>People</b> who are <b>ejected are 40 times more likely to DIE</b> . Safety belts help prevent ejection, WE CAN’T “PICK OUR CRASH”.



**WARNING:** Do not sit on top of a buckled safety belt or insert a latchplate into the buckle to avoid the Belt-Minder® chime. To do so may adversely affect the performance of the vehicle’s air bag system

## Seating and Safety Restraints

### **Deactivating/activating the Belt-Minder® feature (if equipped)**

Read Steps 1 - 4 thoroughly before proceeding with the deactivation/activation programming procedure.

**Note:** If you are using MyKey™, the Belt-Minder® cannot be disabled. Also, if the Belt-Minder® has been previously disabled, it will be re-enabled after the use of MyKey™. Refer to *MyKey™* in the *Locks and security* chapter.

The driver Belt-Minder® feature can be deactivated/activated by performing the following procedure:

Before following the procedure, make sure that:

- The parking brake is set
- The gearshift is in P (Park)
- The ignition switch is in the off position
- The driver and passenger safety belts are unbuckled



**WARNING:** While the design allows you to deactivate your Belt-Minder®, this system is designed to improve your chances of being safely belted and surviving an accident. We recommend you leave the Belt-Minder® system activated for yourself and others who may use the vehicle. To reduce the risk of injury, do not deactivate/activate the Belt-Minder® feature while driving the vehicle.

1. Turn the ignition switch to the on position. DO NOT START THE ENGINE.
2. Wait until the safety belt warning light turns off (Approximately one minute).
  - Step 3 must be completed within 50 seconds after the safety belt warning light turns off.
3. Buckle then unbuckle the safety belt nine times at a moderate speed, ending in the unbuckled state.
  - After Step 3, the safety belt warning light will be turned on for three seconds.
4. Within approximately seven seconds of the light turning off, buckle then unbuckle the safety belt.
  - This will disable the Belt-Minder® feature for that seating position if it is currently enabled. As confirmation, the safety belt warning light will flash four times per second for three seconds.

## Seating and Safety Restraints

- This will enable the Belt-Minder® feature for that seating position if it is currently disabled. As confirmation, the safety belt warning light will flash four times per second for three seconds, followed by three seconds with the light off, then followed by the safety belt warning light flashing four times per second for three seconds again.

### AIRBAG SUPPLEMENTAL RESTRAINT SYSTEM (SRS)

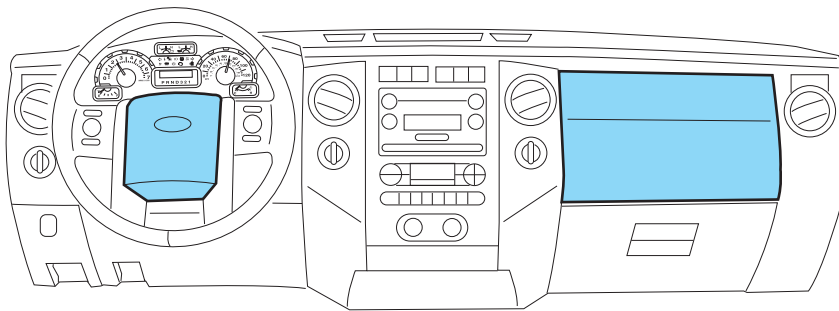

#### Important SRS precautions

The SRS is designed to work with the safety belt to help protect the driver and right front passenger from certain upper body injuries. Airbags DO NOT inflate slowly; there is a risk of injury from a deploying airbag.

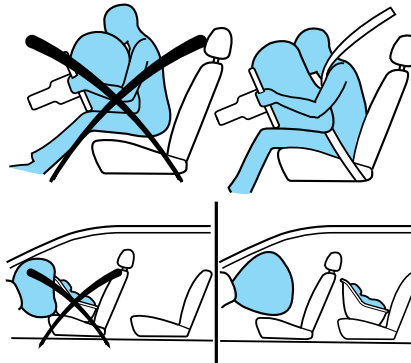

**!** **WARNING:** All occupants of the vehicle, including the driver, should always properly wear their safety belts, even when an air bag supplemental restraint system (SRS) is provided.

## Seating and Safety Restraints



**WARNING:** When possible, all children 12 years old and under should be properly restrained in a rear seating position.



**WARNING:** The National Highway Traffic Safety Administration (NHTSA) recommends a minimum distance of at least 10 inches (25 cm) between an occupant's chest and the driver airbag module.



**WARNING:** Never place your arm over the airbag module as a deploying airbag can result in serious arm fractures or other injuries.

To properly position yourself away from the airbag:

- Move your seat to the rear as far as you can while still reaching the pedals comfortably.
- Recline the seat slightly one or two degrees from the upright position.



**WARNING:** Do not put anything on or over the airbag module. Placing objects on or over the airbag inflation area may cause those objects to be propelled by the airbag into your face and torso causing serious injury.



**WARNING:** Do not attempt to service, repair, or modify the airbag supplemental restraint systems or its fuses. Contact your authorized dealer as soon as possible.



**WARNING:** The front passenger airbag is not designed to offer protection to an occupant in the center front seating position.



**WARNING:** Modifying or adding equipment to the front end of the vehicle (including frame, bumper, front end body structure and tow hooks) may affect the performance of the airbag system, increasing the risk of injury. Do not modify the front end of the vehicle.



**WARNING:** Additional equipment may affect the performance of the airbag sensors increasing the risk of injury.

## Seating and Safety Restraints

### Children and airbags

Children must always be properly restrained. Accident statistics suggest that children are safer when properly restrained in the rear seating positions than in the front seating position. Failure to follow these instructions may increase the risk of injury in a collision.

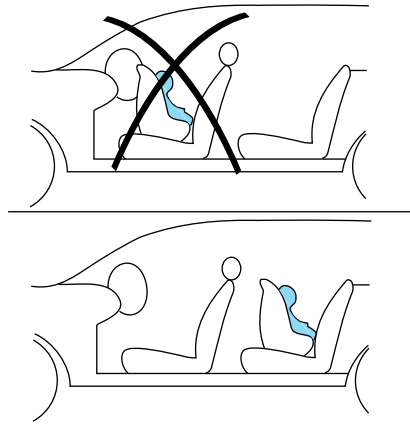

**!** **WARNING:** Airbags can kill or injure a child in a child seat. **NEVER** place a rear-facing child seat in front of an active airbag. If you must use a forward-facing child seat in the front seat, move the seat all the way back.

### How does the airbag supplemental restraint system work?

The airbag SRS is designed to activate when the vehicle sustains longitudinal deceleration sufficient to cause the sensors to close an electrical circuit that initiates airbag inflation.

The fact that the airbags did not inflate in a collision does not mean that something is wrong with the system. Rather, it means the forces were not of the type sufficient to cause activation. The driver and passenger airbags are designed to inflate in frontal and near-frontal collisions, not rollover, side-impact, or rear-impacts unless the collision causes sufficient longitudinal deceleration.

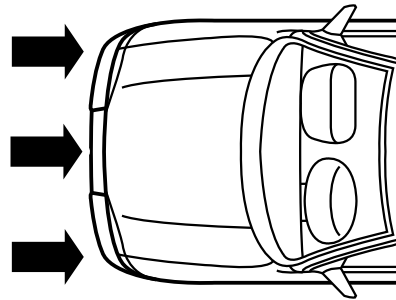

## Seating and Safety Restraints

The airbags inflate and deflate rapidly upon activation. After airbag deployment, it is normal to notice a smoke-like, powdery residue or smell the burnt propellant. This may consist of cornstarch, talcum powder (to lubricate the bag) or sodium compounds (e.g., baking soda) that result from the combustion process that inflates the airbag. Small amounts of sodium hydroxide may be present which may irritate the skin and eyes, but none of the residue is toxic.



While the system is designed to help reduce serious injuries, contact with a deploying airbag may also cause abrasions, swelling or temporary hearing loss. Because airbags must inflate rapidly and with considerable force, there is the risk of death or serious injuries such as fractures, facial and eye injuries or internal injuries, particularly to occupants who are not properly restrained or are otherwise out of position at the time of airbag deployment. Thus, it is extremely important that occupants be properly restrained as far away from the airbag module as possible while maintaining vehicle control.



**WARNING:** Several air bag system components get hot after inflation. Do not touch them after inflation.



**WARNING:** If the airbag has deployed, **the airbag will not function again and must be replaced immediately.** If the airbag is not replaced, the unrepaired area will increase the risk of injury in a collision.

The SRS consists of:

- driver and passenger airbag modules (which include the inflators and airbags),
- seat-mounted side airbags. Refer to *Seat-mounted side airbag system* later in this chapter
- Safety Canopy® System. Refer to *Safety Canopy® System* later in this chapter.



## Seating and Safety Restraints

- one or more impact and safing sensors and diagnostic monitor (RCM),
- a readiness light and tone
- the electrical wiring which connects the components.

The RCM (restraints control module) monitors its own internal circuits and the supplemental airbag electrical system wiring (including the impact sensors, the system wiring, the airbag system readiness light, the airbag backup power and the airbag ignitors).

### Determining if the system is operational

The SRS uses a readiness light in the instrument cluster or a tone to indicate the condition of the system. Refer to the *Warning lights and chimes* section in the *Instrument Cluster* chapter. Routine maintenance of the airbag is not required.

A difficulty with the system is indicated by one or more of the following:

- The readiness light will either flash or stay lit.
- The readiness light will not illuminate immediately after ignition is turned on.
- A series of five beeps will be heard. The tone pattern will repeat periodically until the problem and/or light are repaired.



If any of these things happen, even intermittently, contact your authorized dealer as soon as possible. Unless serviced, the system may not function properly in the event of a collision.

### Seat-mounted side airbag system



**WARNING:** Do not place objects or mount equipment on or near the airbag cover on the side of the seatbacks of the front seats or in front seat areas that may come into contact with a deploying airbag. Failure to follow these instructions may increase the risk of personal injury in the event of a collision.





**WARNING:** Do not use accessory seat covers. The use of accessory seat covers may prevent the deployment of the side airbags and increase the risk of injury in an accident.



**WARNING:** Do not lean your head on the door. The side airbag could injure you as it deploys from the side of the seatback.

## Seating and Safety Restraints

 **WARNING:** Do not attempt to service, repair, or modify the airbag SRS, its fuses or the seat cover on a seat containing an airbag. Contact your authorized dealer as soon as possible.

 **WARNING:** All occupants of the vehicle should always wear their safety belts even when an airbag SRS is provided.

### ***How does the side airbag system work?***

The design and development of the side airbag system included recommended testing procedures that were developed by a group of automotive safety experts known as the Side Airbag Technical Working Group. These recommended testing procedures help reduce the risk of injuries related to the deployment of side airbags.

The side airbag system consists of the following:

- An inflatable bag (airbag) with an inflator concealed behind the outboard bolster of the driver and front passenger seatbacks.
- A special seat cover designed to allow airbag deployment.
- The same warning light, electronic control and diagnostic unit as used for the front airbags.
- Crash sensors located on the front doors and C pillars (one sensor on each pillar on each side of the vehicle).

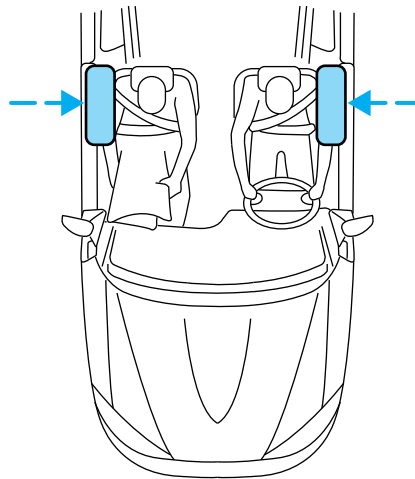

Side airbags, in combination with safety belts, can help reduce the risk of severe injuries in the event of a significant side impact collision.

The side airbags are fitted on the outboard side of the seatbacks of the front seats. In certain lateral collisions, the airbag on the side affected by the collision will be inflated. The airbag was designed to inflate between the door panel and occupant to further enhance the protection provided occupants in side impact collisions.

The airbag SRS is designed to activate when the vehicle sustains lateral deceleration sufficient to cause the sensors to close an electrical circuit that initiates airbag inflation.

## Seating and Safety Restraints

The fact that the airbags did not inflate in a collision does not mean that something is wrong with the system. Rather, it means the forces were not of the type sufficient to cause activation. Side airbags are designed to inflate in side-impact collisions, not roll-over, rear-impact, frontal or near-frontal collisions, unless the collision causes sufficient lateral deceleration.

 **WARNING:** Several air bag system components get hot after inflation. Do not touch them after inflation.

 **WARNING:** If the side airbag has deployed, **the airbag will not function again. The side airbag system (including the seat) must be inspected and serviced by an authorized dealer** . If the airbag is not replaced, the unrepaired area will increase the risk of injury in a collision.

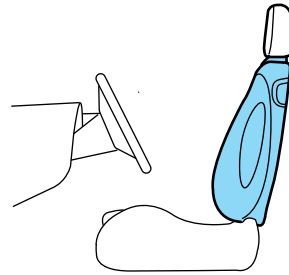

### Safety Canopy® System

 **WARNING:** Do not place objects or mount equipment on or near the headliner at the siderail that may come into contact with a deploying Safety Canopy®. Failure to follow these instructions may increase the risk of personal injury in the event of a collision.

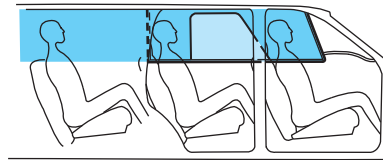

 **WARNING:** Do not lean your head on the door. The Safety Canopy® could injure you as it deploys from the headliner.

 **WARNING:** Do not attempt to service, repair, or modify the Safety Canopy® System, its fuses, the A, B, C or D pillar trim, or the headliner on a vehicle containing a Safety Canopy®. See your authorized dealer.

## Seating and Safety Restraints

 **WARNING:** All occupants of the vehicle including the driver should always wear their safety belts even when an airbag SRS and Safety Canopy® System is provided.

 **WARNING:** To reduce risk of injury, do not obstruct or place objects in the deployment path of the inflatable Safety Canopy®.

### **How does the Safety Canopy® System work?**

The design and development of the Safety Canopy System included recommended testing procedures that were developed by a group of automotive safety experts known as the Side Airbag Technical Working Group. These recommended testing procedures help reduce the risk of injuries related to the deployment of side airbags (including the Safety Canopy®).

The Safety Canopy System consists of the following:

- An inflatable curtain with a gas generator concealed behind the headliner and above the doors (one on each side of vehicle).
- A headliner designed to flex open above the side doors to allow safety canopy deployment.
- The same readiness airbag light, electronic control and diagnostic unit as used for the front airbags.
- Two crash sensors mounted in the front doors (one on each side of the vehicle).
- Two crash sensors located at the C pillar behind the rear doors (one on each side of the vehicle).
- Rollover sensor in the restraints control module (RCM).

The Safety Canopy System, in combination with safety belts, can help reduce the risk of severe injuries in the event of a significant side impact collision or rollover event.

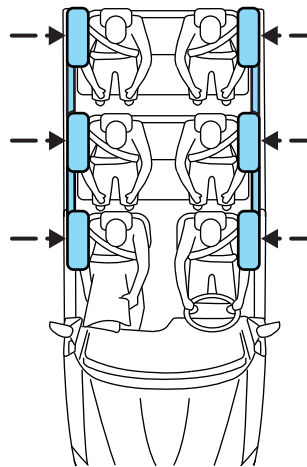

## Seating and Safety Restraints

Children 12 years old and under should always be properly restrained in the second or third row seats. The safety canopy will not interfere with children restrained using a properly installed child or booster seat because it is designed to inflate downward from the headliner above the doors along the side window opening.

The Safety Canopy System is designed to activate when the vehicle sustains lateral deceleration sufficient to cause the side crash sensor to close an electrical circuit that initiates safety canopy inflation or when a certain likelihood of a rollover event is detected by the rollover sensor.

The safety canopy is mounted to roof side-rail sheet metal, behind the headliner, above each row of seats. In certain lateral collisions or rollover events, the Safety Canopy System will be activated, regardless of which seats are occupied. The safety canopy is designed to inflate between the side window area and occupants to further enhance protection provided in side impact collisions and rollover events.

The fact that the safety canopy did not activate in a collision does not mean that something is wrong with the system. Rather, it means the forces were not of the type sufficient to cause activation. The safety canopy is designed to inflate in certain side impact collisions or rollover events, not in rear impact, frontal or near-frontal collisions, unless the collision causes sufficient lateral deceleration or rollover.



**WARNING:** Several Safety Canopy System components get hot after inflation. Do not touch them after inflation.



**WARNING:** If the Safety Canopy System has deployed, the safety canopy will not function again unless replaced. The Safety Canopy System (including the A, B, C, and D pillar trim and headliner) must be inspected and serviced by an authorized dealer. If the safety canopy is not replaced, it will not function again, which will increase the risk of injury in a future collision.

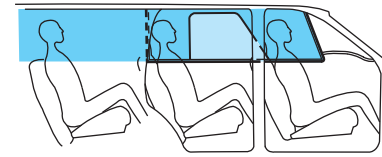

## Seating and Safety Restraints

### ***Determining if the system is operational***

The SRS uses a readiness light in the instrument cluster or a tone to indicate the condition of the system. Refer to the *Airbag readiness* section in the *Instrument Cluster* chapter. Routine maintenance of the airbag is not required.

Any difficulty with the system is indicated by one or more of the following:

- The readiness light (same light as for front airbag system) will either flash or stay lit.
- The readiness light will not illuminate immediately after ignition is turned on.
- A series of five beeps will be heard. The tone pattern will repeat periodically until the problem and light are repaired.

If any of these things happen, even intermittently, contact your authorized dealer as soon as possible. Unless serviced, the system may not function properly in the event of a collision or rollover event.

### **SOS Post-Crash Alert System™**

The system automatically flashes the turn signal lamps and sounds the horn three times at four second intervals in the event of a serious impact that deploys an airbag (front, side, side curtain or Safety Canopy®) or the safety belt pretensioners.

The system can be turned off when any one of the following actions are taken by the driver or any other person:

- pressing the hazard control button,
- or pressing the panic button on the remote entry transmitter.

The feature will continue to operate until the vehicle runs out of power.

### **Disposal of airbags and airbag equipped vehicles (including pretensioners)**

Contact your authorized dealer as soon as possible. Airbags MUST BE disposed of by qualified personnel.

## Seating and Safety Restraints

### SAFETY RESTRAINTS FOR CHILDREN

See the following sections for directions on how to properly use safety restraints for children. Also see *Airbag supplemental restraint system (SRS)* in this chapter for special instructions about using airbags.

#### Important child restraint precautions



**WARNING:** Always make sure your child is secured properly in a device that is appropriate for their height, age and weight. Child safety restraints must be purchased separately from the vehicle. Failure to follow these instructions and guidelines may result in an increased risk of serious injury or death to your child.



**WARNING:** All children are shaped differently. The Recommendations for Safety Restraints are based on probable child height, age and weight thresholds from NHTSA and other safety organizations or are the minimum requirements of law. Ford recommends checking with a NHTSA Certified Child Passenger Safety Technician (CPST) and consult your pediatrician to make sure your child seat is appropriate for your child, and is compatible with and properly installed in the vehicle. To locate a child seat fitting station and CPST contact the NHTSA toll free at 1-888-327-4236 or on the internet at <http://www.nhtsa.dot.gov>. In Canada, check with your local St. John Ambulance office for referral to a CPST or for further information, contact your provincial ministry of transportation, your local St. John Ambulance office at <http://www.sfa.ca>, or Transport Canada at 1-800-333-0371 (<http://www.tc.gc.ca>). Failure to properly restrain children in safety seats made especially for their height, age, and weight may result in an increased risk of serious injury or death to your child.

## Seating and Safety Restraints

<b>Recommendations for Safety Restraints for Children</b>		
	<b>Child size, height, weight, or age</b>	<b>Recommended restraint type</b>
Infants or toddlers	Children weighing 40 lb (18 kg) or less (generally age four or younger)	Use a child safety seat (sometimes called an infant carrier, convertible seat, or toddler seat).
Small children	Children who have outgrown or no longer properly fit in a child safety seat (generally children who are less than 4 feet 9 inches (1.45 meters) tall, are greater than age four (4) and less than age twelve (12), and between 40 lb (18 kg) and 80 lb (36 kg) and upward to 100 lb (45 kg) if recommended by your child restraint manufacturer)	Use a belt-positioning booster seat.
Larger children	Children who have outgrown or no longer properly fit in a belt-positioning booster seat (generally children who are at least 4 feet 9 inches (1.45 meters) tall or greater than 80 lb (36 kg) or 100 lb (45 kg) if recommended by child restraint manufacturer)	Use a vehicle safety belt having the lap belt snug and low across the hips, shoulder belt centered across the shoulder and chest, and seatback upright.

- You are required by law to properly use safety seats for infants and toddlers in the U.S. and Canada.
- Many states and provinces require that small children use approved booster seats until they reach age eight, a height of 4 ft 9 in. (1.45 meters) tall, or 80 lb (36 kg). Check your local and state or provincial laws for specific requirements regarding the safety of children in your vehicle.
- When possible, always properly restrain children twelve (12) years of age and under in a rear seating position of your vehicle. Accident statistics suggest that children are safer when properly restrained in the rear seating positions than in a front seating position.



## Seating and Safety Restraints

### **Recommendations for attaching child safety restraints for children**

Restraint Type	Child Weight	Use any attachment method as indicated below by "X"				
		LATCH (lower anchors and top tether anchor)	LATCH (lower anchors only)	Safety belt and top tether anchor	Safety belt and LATCH (lower anchors and top tether anchor)	Safety belt only
Rear facing child seat	Up to 48 lb (21 kg)		X			X
Forward facing child seat	Up to 48 lb (21 kg)	X		X	X	
Forward facing child seat	Over 48 lb (21 kg)			X	X	





**WARNING:** Airbags can kill or injure a child in a child seat. NEVER place a rear-facing child seat in front of an active airbag. If you must use a forward-facing child seat in the front seat, move the vehicle seat all the way back. When possible, all children age 12 and under should be properly restrained in a rear seating position. If all children cannot be seated and restrained properly in a rear seating position, properly restrain the largest child in the front seat.

## Seating and Safety Restraints

 **WARNING:** Always carefully follow the instructions and warnings provided by the manufacturer of any child restraint to determine if the restraint device is appropriate for your child's size, height, weight, or age. Follow the child restraint manufacturer's instructions and warnings provided for installation and use in conjunction with the instructions and warnings provided by the vehicle manufacturer. A safety seat that is improperly installed or utilized, is inappropriate for your child's height, age, or weight or does not properly fit the child may increase the risk of serious injury or death.

 **WARNING:** Never let a passenger hold a child on his or her lap while the vehicle is moving. The passenger cannot protect the child from injury in a collision, which may result in serious injury or death.

 **WARNING:** Never use pillows, books, or towels to boost a child. They can slide around and increase the likelihood of injury or death in a collision.

 **WARNING:** Always restrain an unoccupied child seat or booster seat. These objects may become projectiles in a collision or sudden stop, which may increase the risk of serious injury.

 **WARNING:** Never place, or allow a child to place, the shoulder belt under a child's arm or behind the back because it reduces the protection for the upper part of the body and may increase the risk of injury or death in a collision.

 **WARNING:** Do not leave children, unreliable adults, or pets unattended in your vehicle.

### Transporting children

Always make sure your child is secured properly in a device that is appropriate for their age, height and weight. All children are shaped differently. The child height, age and weight thresholds provided are recommendations or the minimum requirements of law. The National Highway Traffic Safety Administration (NHTSA) provides education and

## Seating and Safety Restraints

training to ensure that all children ages 0 to 16 are properly restrained in the correct restraint system. Ford recommends checking with a NHTSA Certified Child Passenger Safety Technician (CPST) and your pediatrician to make sure your seat is appropriate for your child and properly installed in the vehicle. To locate a child seat fitting station and CPST contact the NHTSA toll free at **1-888-327-4236** or on the internet at <http://www.nhtsa.dot.gov>. In Canada, check with your local St. John Ambulance office for referral to a CPST or for further information, contact your provincial ministry of transportation, your local St. John Ambulance office at <http://www.sfa.ca>, or Transport Canada at 1-800-333-0371 (<http://www.tc.gc.ca>).

Follow all the safety restraint and airbag precautions that apply to adult passengers in your vehicle.

If the child is the proper height, age, and weight (as specified by your child safety seat or booster manufacturer), fits the restraint and can be restrained properly, then restrain the child in the child safety seat or with the belt-positioning booster. Remember that child seats and belt-positioning boosters vary and may be designed to fit children of different heights, ages and weights. Children who are too large for child safety seats or belt-positioning boosters (as specified by your child safety seat manufacturer) should always properly wear safety belts.

### SAFETY SEATS FOR CHILDREN

#### Infant and/or toddler seats

Use a safety seat that is recommended for the size and weight of the child.

When installing a child safety seat:

- Review and follow the information presented in the *Airbag supplemental restraint system (SRS)* section in this chapter.
- Carefully follow all of the manufacturer's instructions included with the safety seat you put in your vehicle. If you do not install and use the safety seat properly, the child may be injured in a sudden stop or collision.

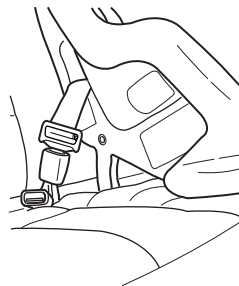

## Seating and Safety Restraints

Airbags can kill or injure a child in a child seat. NEVER place a rear-facing child seat in front of an active airbag. If you must use a forward-facing child seat in the front seat, move the vehicle seat all the way back.

Children 12 and under should be properly restrained in a rear seating position whenever possible. If all children cannot be seated and restrained properly in a rear seating position, properly restrain the largest child in the front seat.

### Installing child safety seats with combination lap and shoulder belts

Check to make sure the child seat is properly secured before each use. Children 12 and under should be properly restrained in a rear seating position whenever possible. If all children cannot be seated and restrained properly in a rear seating position, properly restrain the largest child in the front seat.

When installing a child safety seat with combination lap/shoulder belts:

- Use the correct safety belt buckle for that seating position.
- Insert the belt tongue into the proper buckle until you hear a snap and feel it latch. Make sure the tongue is securely fastened in the buckle.
- Keep the buckle release button pointing up and away from the safety seat, with the tongue between the child seat and the release button, to help prevent accidental unbuckling.
- Place vehicle seat back in upright position.
- Put the safety belt in the automatic locking mode. Refer to Step 5 below. This vehicle does not require the use of a locking clip.



**WARNING:** Depending on where you secure a child restraint, and depending on the child restraint design, you may block access to certain safety belt buckle assemblies and/or LATCH lower anchors, rendering those features potentially unusable. To avoid risk of injury, occupants should only use seating positions where they are able to be properly restrained.

## Seating and Safety Restraints

Perform the following steps when installing the child seat with combination lap/shoulder belts:

**Note:** Although the child seat illustrated is a forward facing child seat, the steps are the same for installing a rear facing child seat.

1. Position the child safety seat in a seat with a combination lap and shoulder belt.

For second row seating positions, if needed, the recliner may be adjusted slightly to improve child seat fit.

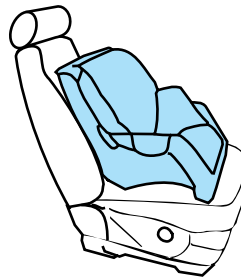

2. Pull down on the shoulder belt and then grasp the shoulder belt and lap belt together.

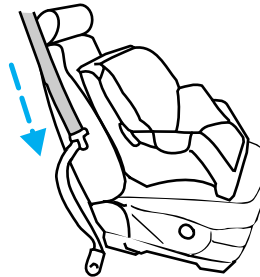

3. While holding the shoulder and lap belt portions together, route the tongue through the child seat according to the child seat manufacturer's instructions. Be sure the belt webbing is not twisted.

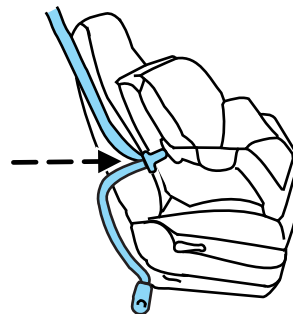

## Seating and Safety Restraints

4. Insert the belt tongue into the proper buckle (the buckle closest to the direction the tongue is coming from) for that seating position until you hear a snap and feel the latch engage. Make sure the tongue is latched securely by pulling on it.

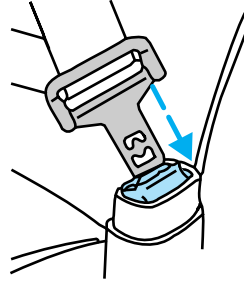

5. To put the retractor in the automatic locking mode, grasp the shoulder portion of the belt and pull downward until all of the belt is pulled out.

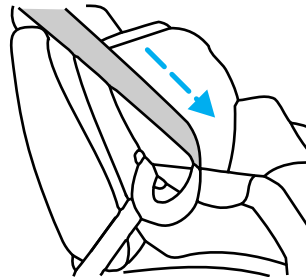

6. Allow the belt to retract to remove slack. The belt will click as it retracts to indicate it is in the automatic locking mode.

7. Try to pull the belt out of the retractor to make sure the retractor is in the automatic locking mode (you should not be able to pull more belt out). If the retractor is not locked, repeat Steps 5 and 6.

8. Remove remaining slack from the belt. Force the seat down with extra weight, e.g., by pressing down or kneeling on the child restraint while pulling up on the shoulder belt in order to force slack from the belt. This is necessary to remove the remaining slack that will exist once the additional weight of the child is added to the child restraint. It also helps to achieve the proper

snugness of the child seat to the vehicle. Sometimes, a slight lean towards the buckle will additionally help to remove remaining slack from the belt.

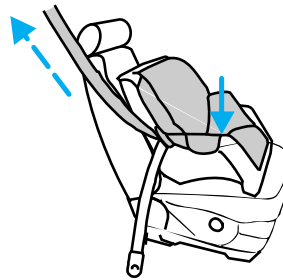

## Seating and Safety Restraints

9. Attach the tether strap (if the child seat is equipped). Refer to *Attaching child safety seats with tether straps* later in this chapter.

10. Before placing the child in the seat, forcibly move the seat forward and back to make sure the seat is securely held in place. To check this, grab the seat at the belt path and attempt to move it side to side and forward and back. There should be no more than 1 inch (2.5 cm) of movement for proper installation.

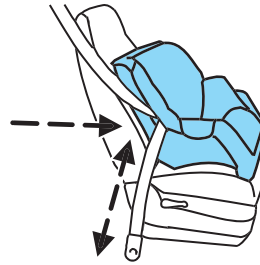

Ford recommends checking with a NHTSA Certified Child Passenger Safety Technician (CPST) to make certain the child restraint is properly installed. In Canada, check with your local St. John Ambulance office for referral to a CPST.

### **Attaching child safety seats with LATCH (Lower Anchors and Tethers for Children) attachments**

The LATCH system is composed of three vehicle anchor points: two (2) lower anchors located where the vehicle seat back and seat cushion meet (called the “seat bight”) and one (1) top tether anchor located behind that seating position.

LATCH compatible child safety seats have two rigid or webbing mounted attachments that connect to the two lower anchors at the LATCH equipped seating positions in your vehicle. This type of attachment method eliminates the need to use safety belts to attach the child seat, however the safety belt can still be used to attach the child seat. For forward-facing child seats, the top tether strap must also be attached to the proper top tether anchor, if a top tether strap has been provided with your child seat. Ford Motor Company recommends the use of a child safety seat having a top tether strap. See *Attaching child safety seats with tether straps* and *Recommendations for attaching child safety restraints for children* in this chapter for more information.

## Seating and Safety Restraints

Your vehicle has LATCH lower anchors for child seat installation at the seating positions marked with the child seat symbol.

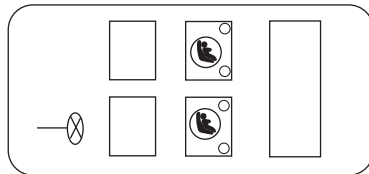
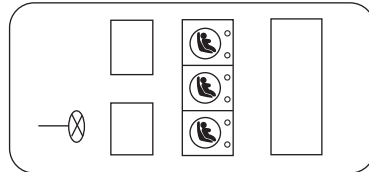

The LATCH anchors are located at the rear section of the rear seat between the cushion and seatback, below the locator symbols on the seat back. Follow the child seat manufacturer's instructions to properly install a child seat with LATCH attachments.

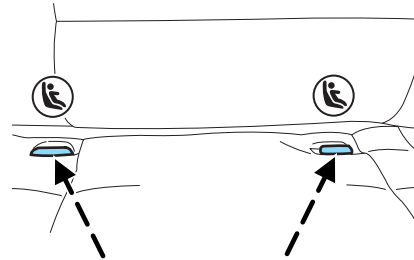

The locator symbols are on round plastic buttons for the center seat and on rectangular tags for the outboard seats.

Follow the instructions on attaching child safety seats with tether straps. Refer to *Attaching child safety seats with tether straps* later in this chapter.

Attach LATCH lower attachments of the child seat only to the anchors shown.



## Seating and Safety Restraints



**WARNING:** Never attach two child safety seats to the same anchor. In a crash, one anchor may not be strong enough to hold two child safety seat attachments and may break, causing serious injury or death.

Each time you use the safety seat, check that the seat is properly attached to the lower anchors and tether anchor, if applicable. Tug the child seat from side to side and forward and back where it is secured to the vehicle. The seat should move less than one inch when you do this for a proper installation.

If the safety seat is not anchored properly, the risk of a child being injured in a crash greatly increases.

### **Combining safety belt and LATCH lower anchors for attaching child safety seats**

When used in combination, either the safety belt or the LATCH lower anchors may be attached first, provided a proper installation is achieved. Attach the tether strap afterward, if included with the child seat. Refer to *Recommendations for attaching child safety restraints for children* in this chapter.

### **Attaching child safety seats with tether straps**

Many forward-facing child safety seats include a tether strap which extends from the back of the child safety seat and hooks to an anchoring point called the top tether anchor. Tether straps are available as an accessory for many older safety seats. Contact the manufacturer of your child seat for information about ordering a tether strap, or to obtain a longer tether strap if the tether strap on your safety seat does not reach the appropriate top tether anchor in the vehicle.

Some of the rear seats of your vehicle are equipped with built-in tether strap anchors located behind the seats as described below.

In the third row center seating position, the tether anchor is a loop at the bottom of the seatback.

## Seating and Safety Restraints

The tether strap anchors in your vehicle are in the following positions (shown from top view):

- Second row bench seat

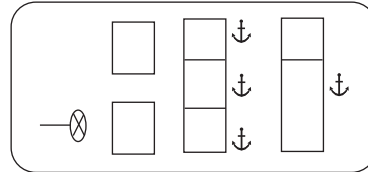

- Second row bucket seats

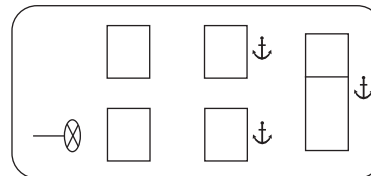

Attach the tether strap only to the appropriate tether anchor as shown. The tether strap may not work properly if attached somewhere other than the correct tether anchor.

Once the child safety seat has been installed using either the safety belt, the lower anchors of the LATCH system, or both, you can attach the top tether strap.

If you install a child seat with rigid LATCH attachments, and have attached the top tether strap to the proper top tether anchor, do not tighten the tether strap enough to lift the child seat off the vehicle seat cushion when the child is seated in it. Keep the tether strap just snug without lifting the front of the child seat. Keeping the child seat just touching the vehicle seat gives the best protection in a severe crash.

Perform the following steps to install a child safety seat with tether anchors:

### Second row seating positions

1. For center seating positions, route the child safety seat tether strap over the back of the seat.

For outboard seating positions, route the tether strap under the head restraint and between the head restraint posts. If the top of the safety seat hits the head restraint, recline the seatback slightly to obtain proper fit.

## Seating and Safety Restraints

2. Locate the correct anchor for the selected seating position.

- Second row outboard seating positions

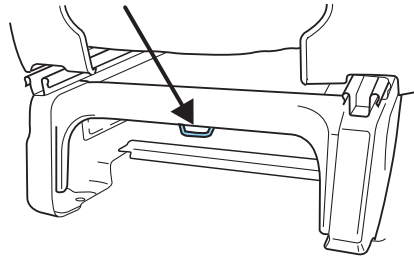

- Second row center seating position (if equipped)

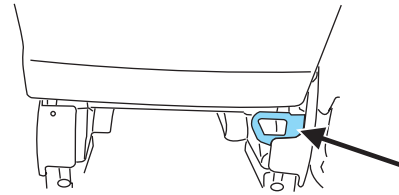

3. Grasp the tether strap and position it to the seat frame.

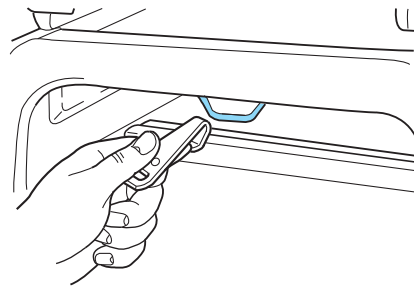

4. Rotate the tether strap, and clip the tether strap to the anchor on the seat frame.

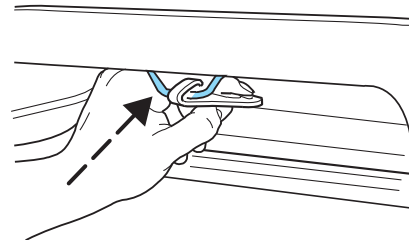

## Seating and Safety Restraints

5. Rotate the tether strap clip.

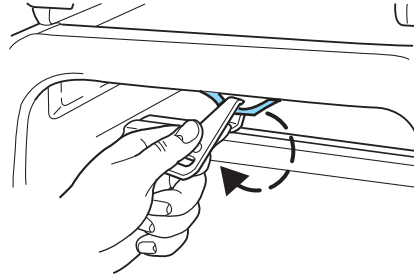

6. Tighten the child safety seat tether strap according to the manufacturer's instructions.

### Third row center seating position

1. Route the child safety seat tether strap over the back of the seat.

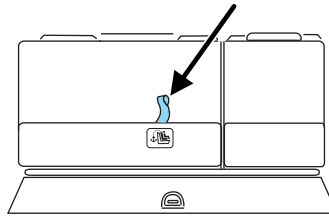

2. Locate the anchor webbing loop for the seating position.

- You may need to pull back the top of the hinged panel along the bottom of the seat back to access the tether anchor.

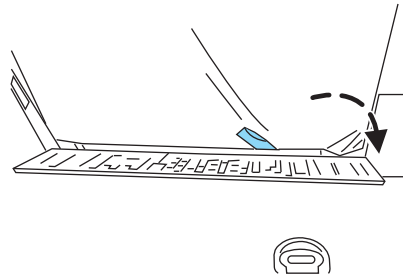

## Seating and Safety Restraints

3. Clip the tether strap through the anchor loop as shown.

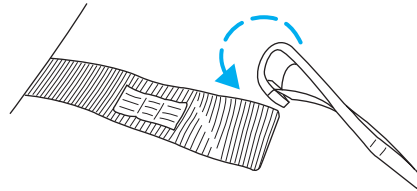

If the tether strap is clipped incorrectly, the child safety seat may not be retained properly in the event of a collision.

4. Tighten the child safety seat tether strap according to the manufacturer's instructions.

If the safety seat is not anchored properly, the risk of a child being injured in a collision greatly increases.

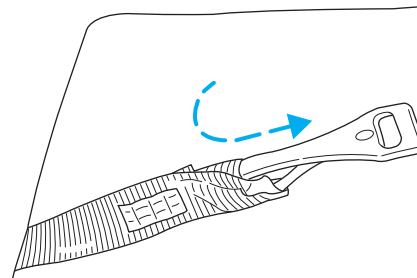

If your child restraint system is equipped with a tether strap, and the child restraint manufacturer recommends its use, Ford also recommends its use.

### Child booster seats

The belt-positioning booster (booster seat) is used to improve the fit of the vehicle safety belt. Children outgrow a typical child seat (e.g., convertible or toddler seat) when they weigh about 40 lb (18 kg) and are around four (4) years of age. Consult your child safety seat owner guide for the weight, height, and age limits specific to your child safety seat. Keep your child in the child safety seat if it properly fits the child, remains appropriate for their weight, height and age AND if properly secured to the vehicle.

Although the lap/shoulder belt will provide some protection, children who have outgrown a typical child seat are still too small for lap/shoulder belts to fit properly, and wearing an improperly fitted vehicle safety belt could increase the risk of serious injury in a crash. To improve the fit of both the lap and shoulder belt on children who have outgrown child safety seats, Ford Motor Company recommends use of a belt-positioning booster.

## Seating and Safety Restraints

Booster seats position a child so that vehicle lap/shoulder safety belts fit better. They lift the child up so that the lap belt rests low across the hips and the knees bend comfortably at the edge of the cushion, while minimizing slouching. Booster seats may also make the shoulder belt fit better and more comfortably. Try to keep the belt near the middle of the shoulder and across the center of the chest. Moving the child closer (a few centimeters or inches) to the center of the vehicle, but remaining in the same seating position, may help provide a good shoulder belt fit.

### **When children should use booster seats**

Children need to use booster seats from the time they outgrow the toddler seat until they are big enough for the vehicle seat and lap/shoulder belt to fit properly. Generally this is when they reach a height of at least 4 feet 9 inches (1.45 meters) tall (around age eight to age twelve and between 40 lb (18 kg) and 80 lb (36 kg) or upward to 100 lb (45 kg) if recommended by your child restraint manufacturer). Many state and provincial laws require that children use approved booster seats until they reach age eight, a height of 4 feet 9 inches (1.45 meters) tall, or 80 lb (36 kg).

Booster seats should be used until you can answer YES to ALL of these questions when seated without a booster seat:

- Can the child sit all the way back against the vehicle seat back with knees bent comfortably at the edge of the seat cushion?
- Can the child sit without slouching?

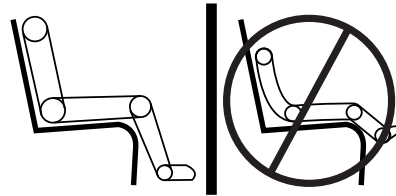

- Does the lap belt rest low across the hips?
- Is the shoulder belt centered on the shoulder and chest?
- Can the child stay seated like this for the whole trip?

## Seating and Safety Restraints

### **Types of booster seats**

There are generally two types of belt-positioning booster seats: backless and high back. Always use booster seats in conjunction with the vehicle lap/shoulder belt.

- **Backless booster seats**

If your backless booster seat has a removable shield, remove the shield. If a vehicle seating position has a low seat back or no head restraint, a backless booster seat may place your child's head (as measured at the tops of the ears) above the top of the seat. In this case, move the backless booster to another seating position with a higher seat back or head restraint and lap/shoulder belts, or consider using a high back booster seat.



- **High back booster seats**

If, with a backless booster seat, you cannot find a seating position that adequately supports your child's head, a high back booster seat would be a better choice.



## Seating and Safety Restraints

Children and booster seats vary in size and shape. Choose a booster that keeps the lap belt low and snug across the hips, never up across the stomach, and lets you adjust the shoulder belt to cross the chest and rest snugly near the center of the shoulder. The drawings below compare the ideal fit (center) to a shoulder belt uncomfortably close to the neck and a shoulder belt that could slip off the shoulder. The drawings below also show how the lap belt should be low and snug across the child's hips.

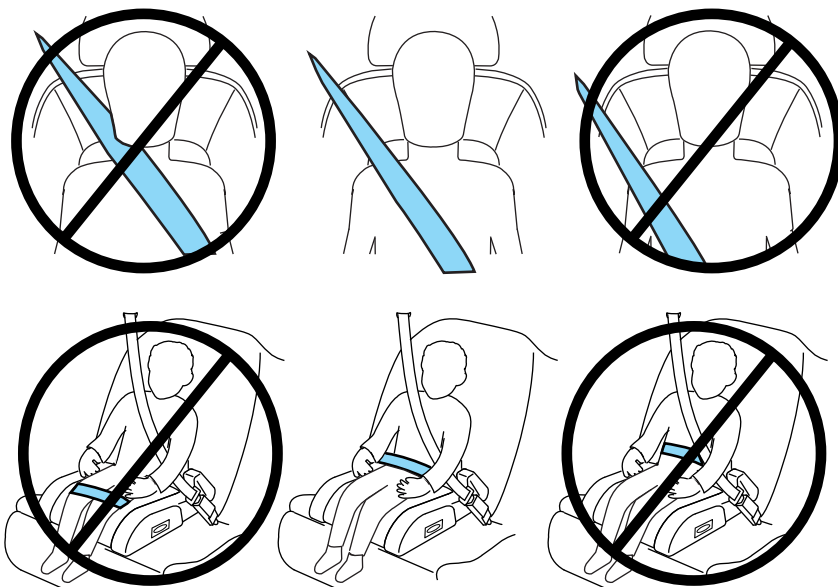

If the booster seat slides on the vehicle seat, placing a rubberized mesh sold as shelf or carpet liner under the booster seat may improve this condition. Do not introduce any item thicker than this under the booster seat. Check with the booster seat manufacturer's instructions.

### ***The importance of shoulder belts***

Using a booster without a shoulder belt increases the risk of a child's head hitting a hard surface in a collision. For this reason, you should never use a booster seat with a lap belt only. It is generally best to use a booster seat with lap/shoulder belts in the back seat.

Move a child to a different seating location if the shoulder belt does not stay positioned on the shoulder during use.



## Seating and Safety Restraints

Follow all instructions provided by the manufacturer of the booster seat.



**WARNING:** Never place, or allow a child to place, the shoulder belt under a child's arm or behind the back because it reduces the protection for the upper part of the body and may increase the risk of injury or death in a collision.

### Child restraints and safety belt maintenance

Inspect the vehicle safety belts and child safety seat systems periodically to make sure they work properly and are not damaged. Inspect the vehicle and child seat safety belts to make sure there are no nicks, tears or cuts. Replace if necessary. All vehicle safety belt assemblies, including retractors, buckles, front safety belt buckle assemblies, buckle support assemblies (slide bar-if equipped), shoulder belt height adjusters (if equipped), shoulder belt guide on seatback (if equipped), child safety seat LATCH and tether anchors, and attaching hardware, should be inspected after a collision. Refer to the child restraint manufacturer's instructions for additional inspection and maintenance information specific to the child restraint. Ford Motor Company recommends that all safety belt assemblies in use in vehicles involved in a collision be replaced. However, if the collision was minor and an authorized dealer finds that the belts do not show damage and continue to operate properly, they do not need to be replaced. Safety belt assemblies not in use during a collision should also be inspected and replaced if either damage or improper operation is noted.

For proper care of soiled safety belts, refer to *Interior* in the *Cleaning* chapter.



**WARNING:** Failure to inspect and if necessary replace the safety belt assembly or child restraint system under the above conditions could result in severe personal injuries in the event of a collision.

## Tires, Wheels and Loading

### NOTICE TO UTILITY VEHICLE AND TRUCK OWNERS

Utility vehicles and trucks handle differently than passenger cars in the various driving conditions that are encountered on streets, highways and off-road. Utility vehicles and trucks are not designed for cornering at speeds as high as passenger cars any more than low-slung sports cars are designed to perform satisfactorily under off-road conditions.

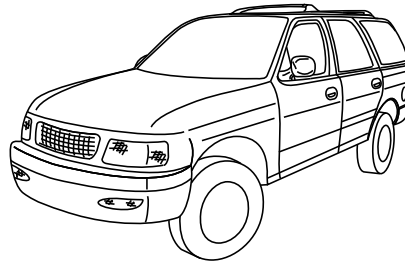

**!** **WARNING:** Utility vehicles have a significantly higher rollover rate than other types of vehicles. To reduce the risk of serious injury or death from a rollover or other crash you must:

- Avoid sharp turns and abrupt maneuvers;
- Drive at safe speeds for the conditions;
- Keep tires properly inflated;
- Never overload or improperly load your vehicle; and
- Make sure every passenger is properly restrained.

**!** **WARNING:** In a rollover crash, an unbelted person is significantly more likely to die than a person wearing a seat belt. All occupants must wear seat belts and children/infants must use appropriate restraints to minimize the risk of injury or ejection.

Study your owner's guide and any supplements for specific information about equipment features, instructions for safe driving and additional precautions to reduce the risk of an accident or serious injury.

### VEHICLE CHARACTERISTICS

#### 4WD and AWD systems (if equipped)

A vehicle equipped with AWD or 4WD (when selected) has the ability to use all four wheels to power itself. This increases traction which may enable you to safely drive over terrain and road conditions that a conventional two-wheel drive vehicle cannot.

## Tires, Wheels and Loading

Power is supplied to all four wheels through a transfer case or power transfer unit. 4WD vehicles allow you to select different drive modes as necessary. Information on transfer case operation and shifting procedures can be found in the *Driving* chapter. Information on transfer case maintenance can be found in the *Maintenance and Specifications* chapter. You should become thoroughly familiar with this information before you operate your vehicle.

On some 4WD models, the initial shift from two-wheel drive to 4WD while the vehicle is moving can cause a momentary clunk and ratcheting sound. These sounds are normal as the front drivetrain comes up to speed and is not cause for concern.

 **WARNING:** Do not become overconfident in the ability of 4WD and AWD vehicles. Although a 4WD or AWD vehicle may accelerate better than two-wheel drive vehicle in low traction situations, it won't stop any faster than two-wheel drive vehicles. Always drive at a safe speed.

### How your vehicle differs from other vehicles

SUVs and trucks can differ from some other vehicles in a few noticeable ways. Your vehicle may be:

- Higher – to allow higher load carrying capacity and to allow it to travel over rough terrain without getting hung up or damaging underbody components.
- Shorter – to give it the capability to approach inclines and drive over the crest of a hill without getting hung up or damaging underbody components. All other things held equal, a shorter wheelbase may make your vehicle quicker to respond to steering inputs than a vehicle with a longer wheelbase.

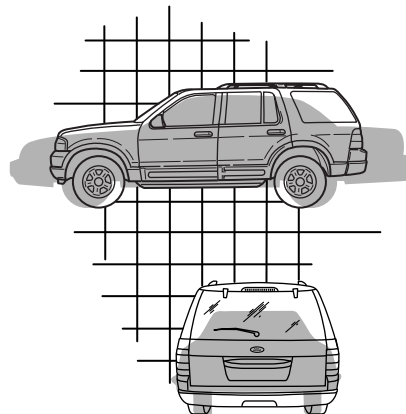

## Tires, Wheels and Loading

- Narrower – to provide greater maneuverability in tight spaces, particularly in off-road use.

As a result of the above dimensional differences, SUVs and trucks often will have a higher center of gravity and a greater difference in center of gravity between the loaded and unloaded condition.

These differences that make your vehicle so versatile also make it handle differently than an ordinary passenger car.

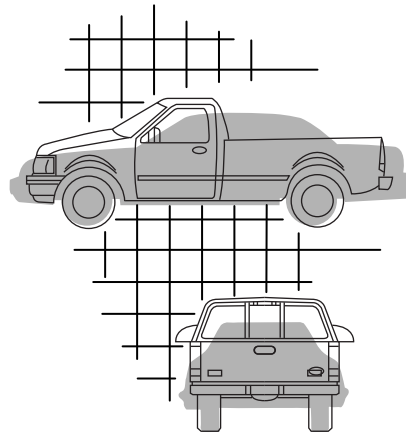

### INFORMATION ABOUT UNIFORM TIRE QUALITY GRADING

Tire Quality Grades apply to new pneumatic passenger car tires. The Quality grades can be found where applicable on the tire sidewall between tread shoulder and maximum section width. For example:

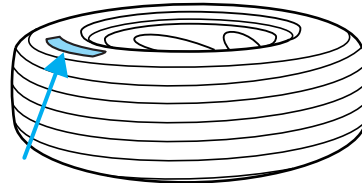

- **Treadwear 200 Traction AA Temperature A**

These Tire Quality Grades are determined by standards that the United States Department of Transportation has set.

Tire Quality Grades apply to new pneumatic passenger car tires. They do not apply to deep tread, winter-type snow tires, space-saver or temporary use spare tires, light truck or “LT” type tires, tires with nominal rim diameters of 10 to 12 inches or limited production tires as defined in Title 49 Code of Federal Regulations Part 575.104(c)(2).

**U.S. Department of Transportation-Tire quality grades:** The U.S. Department of Transportation requires Ford Motor Company to give you the following information about tire grades exactly as the government has written it.

## Tires, Wheels and Loading

### Treadwear

The treadwear grade is a comparative rating based on the wear rate of the tire when tested under controlled conditions on a specified government test course. For example, a tire graded 150 would wear one and one-half (1½) times as well on the government course as a tire graded 100. The relative performance of tires depends upon the actual conditions of their use, however, and may depart significantly from the norm due to variations in driving habits, service practices, and differences in road characteristics and climate.

### Traction AA A B C

The traction grades, from highest to lowest are AA, A, B, and C. The grades represent the tire's ability to stop on wet pavement as measured under controlled conditions on specified government test surfaces of asphalt and concrete. A tire marked C may have poor traction performance.



**WARNING:** The traction grade assigned to this tire is based on straight-ahead braking traction tests, and does not include acceleration, cornering, hydroplaning or peak traction characteristics.

### Temperature A B C

The temperature grades are A (the highest), B and C, representing the tire's resistance to the generation of heat and its ability to dissipate heat when tested under controlled conditions on a specified indoor laboratory test wheel. Sustained high temperature can cause the material of the tire to degenerate and reduce tire life, and excessive temperature can lead to sudden tire failure. The grade C corresponds to a level of performance which all passenger car tires must meet under the Federal Motor Vehicle Safety Standard No. 139. Grades B and A represent higher levels of performance on the laboratory test wheel than the minimum required by law.



**WARNING:** The temperature grade for this tire is established for a tire that is properly inflated and not overloaded. Excessive speed, underinflation, or excessive loading, either separately or in combination, can cause heat buildup and possible tire failure.

## Tires, Wheels and Loading

### TIRES

Tires are designed to give many thousands of miles of service, but they must be maintained in order to get the maximum benefit from them.

#### Glossary of tire terminology

- **Tire label:** A label showing the OE (Original Equipment) tire sizes, recommended inflation pressure and the maximum weight the vehicle can carry.
- **Tire Identification Number (TIN):** A number on the sidewall of each tire providing information about the tire brand and manufacturing plant, tire size and date of manufacture. Also referred to as DOT code.
- **Inflation pressure:** A measure of the amount of air in a tire.
- **Standard load:** A class of P-metric or Metric tires designed to carry a maximum load at 35 psi [37 psi (2.5 bar) for Metric tires]. Increasing the inflation pressure beyond this pressure will not increase the tire's load carrying capability.
- **Extra load:** A class of P-metric or Metric tires designed to carry a heavier maximum load at 41 psi [43 psi (2.9 bar) for Metric tires]. Increasing the inflation pressure beyond this pressure will not increase the tire's load carrying capability.
- **kPa:** Kilopascal, a metric unit of air pressure.
- **PSI:** Pounds per square inch, a standard unit of air pressure.
- **Cold inflation pressure:** The tire pressure when the vehicle has been stationary and out of direct sunlight for an hour or more and prior to the vehicle being driven for 1 mile (1.6 km).
- **Recommended inflation pressure:** The cold inflation pressure found on the Safety Compliance Certification Label or Tire Label located on the B-Pillar or the edge of the driver's door.
- **B-pillar:** The structural member at the side of the vehicle behind the front door.
- **Bead area of the tire:** Area of the tire next to the rim.
- **Sidewall of the tire:** Area between the bead area and the tread.
- **Tread area of the tire:** Area of the perimeter of the tire that contacts the road when mounted on the vehicle.
- **Rim:** The metal support (wheel) for a tire or a tire and tube assembly upon which the tire beads are seated.

## Tires, Wheels and Loading

### INFLATING YOUR TIRES

Safe operation of your vehicle requires that your tires are properly inflated. Remember that a tire can lose up to half of its air pressure without appearing flat.

Every day before you drive, check your tires. If one looks lower than the others, use a tire gauge to check pressure of all tires and adjust if required.

At least once a month and before long trips, inspect each tire and check the tire pressure with a tire gauge (including spare, if equipped). Inflate all tires to the inflation pressure recommended by Ford Motor Company.

You are strongly urged to buy a reliable tire pressure gauge, as automatic service station gauges may be inaccurate. Ford recommends the use of a digital or dial-type tire pressure gauge rather than a stick-type tire pressure gauge.

Use the recommended cold inflation pressure for optimum tire performance and wear. Under-inflation or over-inflation may cause uneven treadwear patterns.



**WARNING:** Under-inflation is the most common cause of tire failures and may result in severe tire cracking, tread separation or “blowout”, with unexpected loss of vehicle control and increased risk of injury. Under-inflation increases sidewall flexing and rolling resistance, resulting in heat buildup and internal damage to the tire. It also may result in unnecessary tire stress, irregular wear, loss of vehicle control and accidents. A tire can lose up to half of its air pressure and not appear to be flat!

Always inflate your tires to the Ford recommended inflation pressure even if it is less than the maximum inflation pressure information found on the tire. The Ford recommended tire inflation pressure is found on the Safety Compliance Certification Label or Tire Label which is located on the B-Pillar or the edge of the driver's door. Failure to follow the tire pressure recommendations can cause uneven treadwear patterns and adversely affect the way your vehicle handles.

**Maximum Permissible Inflation Pressure** is the tire manufacturer's maximum permissible pressure and/or the pressure at which the maximum load can be carried by the tire. This pressure is normally higher than the manufacturer's recommended cold inflation pressure which can be found on the Safety Compliance Certification Label or Tire Label which is located on the B-Pillar or the edge of the driver's door.

## Tires, Wheels and Loading

The cold inflation pressure should never be set lower than the recommended pressure on the Safety Compliance Certification Label or Tire Label.

When weather temperature changes occur, tire inflation pressures also change. A 10°F (6°C) temperature drop can cause a corresponding drop of 1 psi (7 kPa) in inflation pressure. Check your tire pressures frequently and adjust them to the proper pressure which can be found on the Safety Compliance Certification Label or Tire Label.

To check the pressure in your tire(s):

1. Make sure the tires are cool, meaning they are not hot from driving even a mile.

If you are checking tire pressure when the tire is hot, (i.e. driven more than 1 mile [1.6 km]), never “bleed” or reduce air pressure. The tires are hot from driving and it is normal for pressures to increase above recommended cold pressures. A hot tire at or below recommended cold inflation pressure could be significantly under-inflated.

**Note:** If you have to drive a distance to get air for your tire(s), check and record the tire pressure first and add the appropriate air pressure when you get to the pump. It is normal for tires to heat up and the air pressure inside to go up as you drive.

2. Remove the cap from the valve on one tire, then firmly press the tire gauge onto the valve and measure the pressure.

3. Add enough air to reach the recommended air pressure.

**Note:** If you overfill the tire, release air by pressing on the metal stem in the center of the valve. Then recheck the pressure with your tire gauge.

4. Replace the valve cap.

5. Repeat this procedure for each tire, including the spare.

**Note:** Some spare tires operate at a higher inflation pressure than the other tires. For T-type/mini-spare tires (see the *Dissimilar spare tire/wheel information* section for description): Store and maintain at 60 psi (4.15 bar). For full-size and dissimilar spare tires (see the *Dissimilar spare tire/wheel information* section for description): Store and maintain at the higher of the front and rear inflation pressure as shown on the Tire Label.

6. Visually inspect the tires to make sure there are no nails or other objects embedded that could poke a hole in the tire and cause an air leak.

7. Check the sidewalls to make sure there are no gouges, cuts or bulges.



## Tires, Wheels and Loading

### TIRE CARE

#### Inspecting your tires and wheel valve stems

Periodically inspect the tire treads for uneven or excessive wear and remove objects such as stones, nails or glass that may be wedged in the tread grooves. Check the tire and valve stems for holes, cracks, or cuts that may permit air leakage and repair or replace the tire and replace the valve stem. Inspect the tire sidewalls for cracking, cuts, bruises and other signs of damage or excessive wear. If internal damage to the tire is suspected, have the tire demounted and inspected in case it needs to be repaired or replaced. For your safety, tires that are damaged or show signs of excessive wear should not be used because they are more likely to blow out or fail.

Improper or inadequate vehicle maintenance can cause tires to wear abnormally. Inspect all your tires, including the spare, frequently, and replace them if one or more of the following conditions exist:

#### Tire wear

When the tread is worn down to 1/16th of an inch (2 mm), tires must be replaced to help prevent your vehicle from skidding and hydroplaning. Built-in treadwear indicators, or “wear bars”, which look like narrow strips of smooth rubber across the tread will appear on the tire when the tread is worn down to 1/16th of an inch (2 mm). When the tire tread wears down to the same height as these “wear bars”, the tire is worn out and must be replaced.

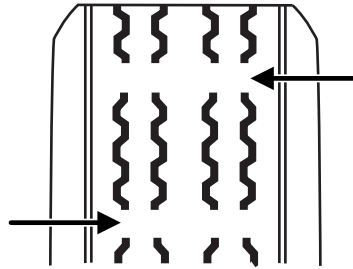

## Tires, Wheels and Loading

### Damage

Periodically inspect the tire treads and sidewalls for damage (such as bulges in the tread or sidewalls, cracks in the tread groove and separation in the tread or sidewall). If damage is observed or suspected have the tire inspected by a tire professional. Tires can be damaged during off-road use, so inspection after off-road use is also recommended.



#### **WARNING: Age**

Tires degrade over time depending on many factors such as weather, storage conditions, and conditions of use (load, speed, inflation pressure, etc.) the tires experience throughout their lives. In general, tires should be replaced after six years regardless of tread wear. However, heat caused by hot climates or frequent high loading conditions can accelerate the aging process and may require tires to be replaced more frequently. You should replace your spare tire when you replace the road tires or after six years due to aging even if it has not been used.

### U.S. DOT Tire Identification Number (TIN)

Both U.S. and Canada Federal regulations require tire manufacturers to place standardized information on the sidewall of all tires. This information identifies and describes the fundamental characteristics of the tire and also provides a U.S. DOT Tire Identification Number for safety standard certification and in case of a recall.

This begins with the letters "DOT" and indicates that the tire meets all federal standards. The next two numbers or letters are the plant code designating where it was manufactured, the next two are the tire size code and the last four numbers represent the week and year the tire was built. For example, the numbers 317 mean the 31st week of 1997. After 2000 the numbers go to four digits. For example, 2501 means the 25th week of 2001. The numbers in between are identification codes used for traceability. This information is used to contact customers if a tire defect requires a recall.

## Tires, Wheels and Loading

### Tire replacement requirements

Your vehicle is equipped with tires designed to provide a safe ride and handling capability.



**WARNING:** Only use replacement tires and wheels that are the same size, load index, speed rating and type (such as P-metric versus LT-metric or all-season versus all-terrain) as those originally provided by Ford. The recommended tire and wheel size may be found on either the Safety Compliance Certification Label or the Tire Label which is located on the B-Pillar or edge of the driver's door. If this information is not found on these labels then you should contact your authorized dealer as soon as possible. Use of any tire or wheel not recommended by Ford can affect the safety and performance of your vehicle, which could result in an increased risk of loss of vehicle control, vehicle rollover, personal injury and death. Additionally the use of non-recommended tires and wheels could cause steering, suspension, axle or transfer case/power transfer unit failure. If you have questions regarding tire replacement, contact your authorized dealer as soon as possible.



**WARNING:** When mounting replacement tires and wheels, you should not exceed the maximum pressure indicated on the sidewall of the tire to set the beads without additional precautions listed below. If the beads do not seat at the maximum pressure indicated, re-lubricate and try again.

When inflating the tire for mounting pressures up to 20 psi (1.38 bar) greater than the maximum pressure on the tire sidewall, the following precautions must be taken to protect the person mounting the tire:

1. Make sure that you have the correct tire and wheel size.
2. Lubricate the tire bead and wheel bead seat area again.
3. Stand at a minimum of 12 ft (3.66 m) away from the tire wheel assembly.
4. Use both eye and ear protection.

For a mounting pressure more than 20 psi (1.38 bar) greater than the maximum pressure, a Ford dealer or other tire service professional should do the mounting.

Always inflate steel carcass tires with a remote air fill with the person inflating standing at a minimum of 12 ft (3.66 m) away from the tire wheel assembly.

## Tires, Wheels and Loading

**Important:** Remember to replace the wheel valve stems when the road tires are replaced on your vehicle.

It is recommended that the two front tires or two rear tires generally be replaced as a pair.

The tire pressure sensors mounted in the wheels (originally installed on your vehicle) are not designed to be used in aftermarket wheels.

The use of wheels or tires not recommended by Ford Motor Company may affect the operation of your tire pressure monitoring system.

If the TPMS indicator is flashing, your TPMS is malfunctioning. Your replacement tire might be incompatible with your TPMS, or some component of the TPMS may be damaged.

### Safety practices

Driving habits have a great deal to do with your tire mileage and safety.

- Observe posted speed limits
- Avoid fast starts, stops and turns
- Avoid potholes and objects on the road
- Do not run over curbs or hit the tire against a curb when parking



**WARNING:** If your vehicle is stuck in snow, mud, sand, etc., **do not** rapidly spin the tires; spinning the tires can tear the tire and cause an explosion. A tire can explode in as little as three to five seconds.



**WARNING:** Do not spin the wheels at over 35 mph (56 km/h). The tires may fail and injure a passenger or bystander.

### Highway hazards

No matter how carefully you drive there's always the possibility that you may eventually have a flat tire on the highway. Drive slowly to the closest safe area out of traffic. This may further damage the flat tire, but your safety is more important.

If you feel a sudden vibration or ride disturbance while driving, or you suspect your tire or vehicle has been damaged, immediately reduce your speed. Drive with caution until you can safely pull off the road. Stop and inspect the tires for damage. If a tire is under-inflated or damaged, deflate it, remove wheel and replace it with your spare tire and wheel. If you cannot detect a cause, have the vehicle towed to the nearest repair facility or tire dealer to have the vehicle inspected.

## Tires, Wheels and Loading

### Tire and wheel alignment

A bad jolt from hitting a curb or pothole can cause the front end of your vehicle to become misaligned or cause damage to your tires. If your vehicle seems to pull to one side when you're driving, the wheels may be out of alignment. Have an authorized dealer check the wheel alignment periodically.

Wheel misalignment in the front or the rear can cause uneven and rapid treadwear of your tires and should be corrected by an authorized dealer. Front-wheel drive (FWD) vehicles and those with an independent rear suspension (if equipped) may require alignment of all four wheels.

The tires should also be balanced periodically. An unbalanced tire and wheel assembly may result in irregular tire wear.

### Tire rotation

Rotating your tires at the recommended interval (as indicated in the *Scheduled Maintenance Guide* chapter) will help your tires wear more evenly, providing better tire performance and longer tire life.

- Rear-wheel drive (RWD) vehicles/Four-wheel drive (4WD) vehicles (front tires at top of diagram)

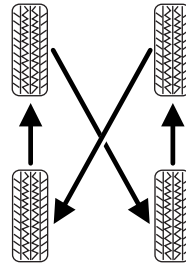

Sometimes irregular tire wear can be corrected by rotating the tires.

**Note:** If your tires show uneven wear ask an authorized dealer to check for and correct any wheel misalignment, tire imbalance or mechanical problem involved before tire rotation.

**Note:** Your vehicle may be equipped with a dissimilar spare tire/wheel. A dissimilar spare tire/wheel is defined as a spare tire and/or wheel that is different in brand, size or appearance from the road tires and wheels. If you have a dissimilar spare tire/wheel it is intended for temporary use only and should not be used in a tire rotation.

**Note:** After having your tires rotated, inflation pressure must be checked and adjusted to the vehicle requirements.

## Tires, Wheels and Loading

### INFORMATION CONTAINED ON THE TIRE SIDEWALL

Both U.S. and Canada Federal regulations require tire manufacturers to place standardized information on the sidewall of all tires. This information identifies and describes the fundamental characteristics of the tire and also provides a U.S. DOT Tire Identification Number for safety standard certification and in case of a recall.

#### Information on “P” type tires

P215/65R15 95H is an example of a tire size, load index and speed rating. The definitions of these items are listed below. (Note that the tire size, load index and speed rating for your vehicle may be different from this example.)

1. **P:** Indicates a tire, designated by the Tire and Rim Association (T&RA), that may be used for service on cars, SUVs, minivans and light trucks.

**Note:** If your tire size does not begin with a letter this may mean it is designated by either ETRTO (European Tire and Rim Technical Organization) or JATMA (Japan Tire Manufacturing Association).

2. **215:** Indicates the nominal width of the tire in millimeters from sidewall edge to sidewall edge. In general, the larger the number, the wider the tire.

3. **65:** Indicates the aspect ratio which gives the tire’s ratio of height to width.

4. **R:** Indicates a “radial” type tire.

5. **15:** Indicates the wheel or rim diameter in inches. If you change your wheel size, you will have to purchase new tires to match the new wheel diameter.

6. **95:** Indicates the tire’s load index. It is an index that relates to how much weight a tire can carry. You may find this information in your Owner’s Guide. If not, contact a local tire dealer.

**Note:** You may not find this information on all tires because it is not required by federal law.

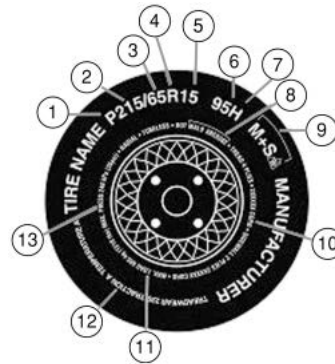

## Tires, Wheels and Loading

7. **H:** Indicates the tire's speed rating. The speed rating denotes the speed at which a tire is designed to be driven for extended periods of time under a standard condition of load and inflation pressure. The tires on your vehicle may operate at different conditions for load and inflation pressure. These speed ratings may need to be adjusted for the difference in conditions. The ratings range from 81 mph (130 km/h) to 186 mph (299 km/h). These ratings are listed in the following chart.

**Note:** You may not find this information on all tires because it is not required by federal law.

Letter rating	Speed rating - mph (km/h)
M	81 mph (130 km/h)
N	87 mph (140 km/h)
Q	99 mph (159 km/h)
R	106 mph (171 km/h)
S	112 mph (180 km/h)
T	118 mph (190 km/h)
U	124 mph (200 km/h)
H	130 mph (210 km/h)
V	149 mph (240 km/h)
W	168 mph (270 km/h)
Y	186 mph (299 km/h)

**Note:** For tires with a maximum speed capability over 149 mph (240 km/h), tire manufacturers sometimes use the letters ZR. For those with a maximum speed capability over 186 mph (299 km/h), tire manufacturers always use the letters ZR.

8. **U.S. DOT Tire Identification Number (TIN):** This begins with the letters "DOT" and indicates that the tire meets all federal standards. The next two numbers or letters are the plant code designating where it was manufactured, the next two are the tire size code and the last four numbers represent the week and year the tire was built. For example, the numbers 317 mean the 31st week of 1997. After 2000 the numbers go to four digits. For example, 2501 means the 25th week of 2001. The numbers in between are identification codes used for traceability. This information is used to contact customers if a tire defect requires a recall.

9. **M+S or M/S:** Mud and Snow, or

**AT:** All Terrain, or

**AS:** All Season.

## Tires, Wheels and Loading

10. **Tire Ply Composition and Material Used:** Indicates the number of plies or the number of layers of rubber-coated fabric in the tire tread and sidewall. Tire manufacturers also must indicate the ply materials in the tire and the sidewall, which include steel, nylon, polyester, and others.

11. **Maximum Load:** Indicates the maximum load in kilograms and pounds that can be carried by the tire. Refer to the Safety Compliance Certification Label, which is located on the B-Pillar or the edge of the driver's door, for the correct tire pressure for your vehicle.

### 12. Treadwear, Traction and Temperature Grades

- **Treadwear:** The treadwear grade is a comparative rating based on the wear rate of the tire when tested under controlled conditions on a specified government test course. For example, a tire graded 150 would wear one and one-half (1½) times as well on the government course as a tire graded 100.
- **Traction:** The traction grades, from highest to lowest are AA, A, B, and C. The grades represent the tire's ability to stop on wet pavement as measured under controlled conditions on specified government test surfaces of asphalt and concrete. A tire marked C may have poor traction performance.
- **Temperature:** The temperature grades are A (the highest), B and C, representing the tire's resistance to the generation of heat and its ability to dissipate heat when tested under controlled conditions on a specified indoor laboratory test wheel.

13. **Maximum Permissible Inflation Pressure:** Indicates the tire manufacturers' maximum permissible pressure and/or the pressure at which the maximum load can be carried by the tire. This pressure is normally higher than the manufacturer's recommended cold inflation pressure which can be found on the Safety Compliance Certification Label or Tire Label which is located on the B-Pillar or the edge of the driver's door. The cold inflation pressure should never be set lower than the recommended pressure on the vehicle label.

The tire suppliers may have additional markings, notes or warnings such as standard load, radial tubeless, etc.



## Tires, Wheels and Loading

### Additional information contained on the tire sidewall for “LT” type tires

“LT” type tires have some additional information beyond those of “P” type tires; these differences are described below.

**Note:** Tire Quality Grades do not apply to this type of tire.

1. **LT:** Indicates a tire, designated by the Tire and Rim Association (T&RA), that is intended for service on light trucks.

#### 2. Load Range/Load Inflation

**Limits:** Indicates the tire’s load-carrying capabilities and its inflation limits.

3. **Maximum Load Dual lb (kg) at psi (kPa) cold:** Indicates the maximum load and tire pressure when the tire is used as a dual; defined as four tires on the rear axle (a total of six or more tires on the vehicle).

4. **Maximum Load Single lb (kg) at psi (kPa) cold:** Indicates the maximum load and tire pressure when the tire is used as a single; defined as two tires (total) on the rear axle.

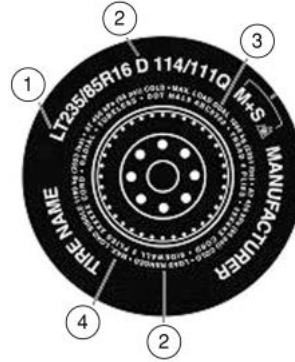

## Tires, Wheels and Loading

### Information on “T” type tires

“T” type tires have some additional information beyond those of “P” type tires; these differences are described below:

T145/80D16 is an example of a tire size.

**Note:** The temporary tire size for your vehicle may be different from this example. Tire Quality Grades do not apply to this type of tire.

1. **T:** Indicates a type of tire, designated by the Tire and Rim Association (T&RA), that is intended for temporary service on cars, SUVs, minivans and light trucks.

2. **145:** Indicates the nominal width of the tire in millimeters from sidewall edge to sidewall edge. In general, the larger the number, the wider the tire.

3. **80:** Indicates the aspect ratio which gives the tire’s ratio of height to width. Numbers of 70 or lower indicate a short sidewall.

4. **D:** Indicates a “diagonal” type tire.  
**R:** Indicates a “radial” type tire.

5. **16:** Indicates the wheel or rim diameter in inches. If you change your wheel size, you will have to purchase new tires to match the new wheel diameter.

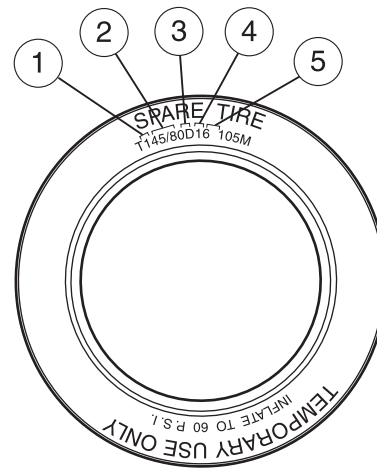

### Location of the tire label

You will find a Tire Label containing tire inflation pressure by tire size and other important information located on the B-Pillar or the edge of the driver’s door. Refer to the payload description and graphic in the *Vehicle loading — with and without a trailer* section.

## Tires, Wheels and Loading

### TIRE PRESSURE MONITORING SYSTEM (TPMS)

Each tire, including the spare (if provided), should be checked monthly when cold and inflated to the inflation pressure recommended by the vehicle manufacturer on the vehicle placard or tire inflation pressure label. (If your vehicle has tires of a different size than the size indicated on the vehicle placard or tire inflation pressure label, you should determine the proper tire inflation pressure for those tires.)

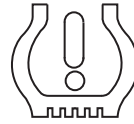

As an added safety feature, your vehicle has been equipped with a tire pressure monitoring system (TPMS) that illuminates a low tire pressure telltale when one or more of your tires is significantly under-inflated. Accordingly, when the low tire pressure telltale illuminates, you should stop and check your tires as soon as possible, and inflate them to the proper pressure. Driving on a significantly under-inflated tire causes the tire to overheat and can lead to tire failure. Under-inflation also reduces fuel efficiency and tire tread life, and may affect the vehicle's handling and stopping ability.

Please note that the TPMS is not a substitute for proper tire maintenance, and it is the driver's responsibility to maintain correct tire pressure, even if under-inflation has not reached the level to trigger illumination of the TPMS low tire pressure telltale.

Your vehicle has also been equipped with a TPMS malfunction indicator to indicate when the system is not operating properly. The TPMS malfunction indicator is combined with the low tire pressure telltale. When the system detects a malfunction, the telltale will flash for approximately one minute and then remain continuously illuminated. This sequence will continue upon subsequent vehicle start-ups as long as the malfunction exists.

When the malfunction indicator is illuminated, the system may not be able to detect or signal low tire pressure as intended. TPMS malfunctions may occur for a variety of reasons, including the installation of replacement or alternate tires or wheels on the vehicle that prevent the TPMS from functioning properly. Always check the TPMS malfunction telltale after replacing one or more tires or wheels on your vehicle to ensure that the replacement or alternate tires and wheels allow the TPMS to continue to function properly.

The tire pressure monitoring system complies with part 15 of the FCC rules and with RSS-210 of Industry Canada. Operation is subject to the

## Tires, Wheels and Loading

following two conditions: (1) This device may not cause harmful interference, and (2) This device must accept any interference received, including interference that may cause undesired operation.



**WARNING:** The tire pressure monitoring system is NOT a substitute for manually checking tire pressure. The tire pressure should be checked periodically (at least monthly) using a tire gauge, see *Inflating your tires* in this chapter. Failure to properly maintain your tire pressure could increase the risk of tire failure, loss of control, vehicle rollover and personal injury.

### Changing tires with TPMS

**Each road tire is equipped with a tire pressure sensor located inside the tire/wheel cavity. The pressure sensor is attached to the valve stem. The pressure sensor is covered by the tire and is not visible unless the tire is removed. Care must be taken when changing the tire to avoid damaging the sensor.** It is

recommended that you always have your tires serviced by an authorized dealer.

The tire pressure should be checked periodically (at least monthly) using an accurate tire gauge, refer to *Inflating your tires* in this chapter.

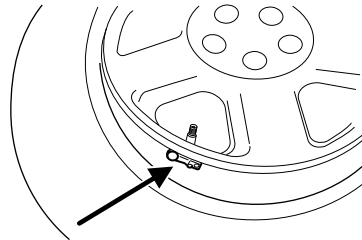

### Understanding your tire pressure monitoring system (TPMS)

The tire pressure monitoring system measures pressure in your four road tires and sends the tire pressure readings to your vehicle. The low tire pressure warning lamp will turn on if the tire pressure is significantly low. Once the light is illuminated, your tires are under inflated and need to be inflated to the manufacturer's recommended tire pressure. Even if the light turns on and a short time later turns off, your tire pressure still needs to be checked. Visit [www.checkmytires.org](http://www.checkmytires.org) for additional information.

### ***When your temporary spare tire is installed***

When one of your road tires needs to be replaced with the temporary spare, the TPMS system will continue to identify an issue to remind you that the damaged road wheel/tire needs to be repaired and put back on your vehicle.

## Tires, Wheels and Loading

To restore the full functionality of the tire pressure monitoring system, have the damaged road wheel/tire repaired and remounted on your vehicle. For additional information, refer to *Changing tires with TPMS* in this section.

### **When you believe your system is not operating properly**

The main function of the tire pressure monitoring system is to warn you when your tires need air. It can also warn you in the event the system is no longer capable of functioning as intended. Please refer to the following chart for information concerning your tire pressure monitoring system:

Low tire pressure warning light	Possible cause	Customer action required
Solid warning light	Tire(s) under-inflated	1. Check your tire pressure to ensure tires are properly inflated; refer to <i>Inflating your tires</i> in this chapter. 2. After inflating your tires to the manufacturer's recommended inflation pressure as shown on the Tire Label (located on the edge of driver's door or the B-Pillar), the vehicle must be driven for at least two minutes over 20 mph (32 km/h) before the light will turn off.
	Spare tire in use	Your temporary spare tire is in use. Repair the damaged road wheel/tire and reinstall it on the vehicle to restore system functionality. For a description on how the system functions, refer to <i>When your temporary spare tire is installed</i> in this section.
	TPMS malfunction	If your tires are properly inflated and your spare tire is not in use and the light remains on, contact your authorized dealer as soon as possible.

## Tires, Wheels and Loading

Low tire pressure warning light	Possible cause	Customer action required
Flashing warning light	Spare tire in use	Your temporary spare tire is in use. Repair the damaged road wheel and re-mount it on the vehicle to restore system functionality. For a description of how the system functions under these conditions, refer to <i>When your temporary spare tire is installed</i> in this section.
	TPMS malfunction	If your tires are properly inflated and your spare tire is not in use and the TPMS warning light still flashes, contact your authorized dealer as soon as possible.

### **When inflating your tires**

When putting air into your tires (such as at a gas station or in your garage), the tire pressure monitoring system may not respond immediately to the air added to your tires.

It may take up to two minutes of driving over 20 mph (32 km/h) for the light to turn off after you have filled your tires to the recommended inflation pressure.

### **How temperature affects your tire pressure**

The tire pressure monitoring system (TPMS) monitors tire pressure in each pneumatic tire. While driving in a normal manner, a typical passenger tire inflation pressure may increase approximately 2 to 4 psi (14 to 28 kPa) from a cold start situation. If the vehicle is stationary over night with the outside temperature significantly lower than the daytime temperature, the tire pressure may decrease approximately 3 psi (21 kPa) for a drop of 30°F (17°C) in ambient temperature. This lower pressure value may be detected by the TPMS as being significantly lower than the recommended inflation pressure and activate the TPMS warning for low tire pressure. If the low tire pressure warning light is on, visually check each tire to verify that no tire is flat. (If one or more tires are flat, repair as necessary.) Check air pressure in the road tires. If any tire is under-inflated, carefully drive the vehicle to the nearest location where air can be added to the tires. Inflate all the tires to the recommended inflation pressure.

## Tires, Wheels and Loading

### SNOW TIRES AND CHAINS



**WARNING:** Snow tires must be the same size, load index, speed rating as those originally provided by Ford. Use of any tire or wheel not recommended by Ford can affect the safety and performance of your vehicle, which could result in an increased risk of loss of vehicle control, vehicle rollover, personal injury and death. Additionally, the use of non-recommended tires and wheels could cause steering, suspension, axle or transfer case/power transfer unit failure.

The tires on your vehicle have all weather treads to provide traction in rain and snow. However, in some climates, you may need to use snow tires and chains. If you need to use chains, it is recommended that steel wheels (of the same size and specifications) be used, as chains may chip aluminum wheels.

**Note:** The suspension insulation and bumpers will help prevent vehicle damage. Do not remove these components from your vehicle when using snow tires and chains.

Follow these guidelines when using snow tires and chains:

- If possible, avoid fully loading your vehicle.
- Use only cable type chains or chains offered by Ford as an accessory or equivalent. Other conventional link type chains may contact and cause damage to the vehicle's wheel house and/or body.
- Do not install chains on the front wheels as this may interfere with suspension components.
- Chains are not recommended for use on the P275/55R20 tire.
- Install chains securely, verifying that the chains do not touch any wiring, brake lines or fuel lines.
- Do not exceed 30 mph (48 km/h) with tire chains on your vehicle.
- Drive cautiously. If you hear the chains rub or bang against your vehicle, stop and retighten the chains. If this does not work, remove the chains to prevent damage to your vehicle.
- Remove the tire chains when they are no longer needed. Do not use tire chains on dry roads.

### VEHICLE LOADING – WITH AND WITHOUT A TRAILER

This section will guide you in the proper loading of your vehicle and/or trailer, to keep your loaded vehicle weight within its design rating capability, with or without a trailer. Properly loading your vehicle will

## Tires, Wheels and Loading

provide maximum return of vehicle design performance. Before loading your vehicle, familiarize yourself with the following terms for determining your vehicle's weight ratings, with or without a trailer, from the vehicle's Tire Label or Safety Compliance Certification Label:

**Base Curb Weight** – is the weight of the vehicle including a full tank of fuel and all standard equipment. It does not include passengers, cargo, or optional equipment.

**Vehicle Curb Weight** – is the weight of your new vehicle when you picked it up from your authorized dealer plus any aftermarket equipment.

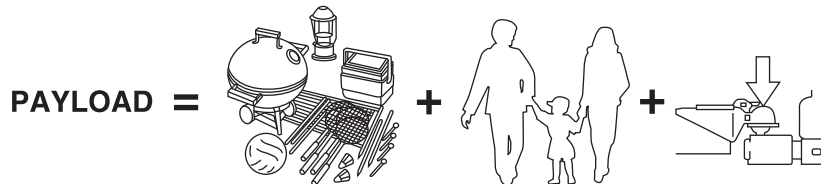

**Payload** – is the combined weight of cargo and passengers that the vehicle is carrying. The maximum payload for your vehicle can be found on the Tire Label on the B-Pillar or the edge of the driver's door (vehicles exported outside the US and Canada may not have a Tire Label). Look for **“THE COMBINED WEIGHT OF OCCUPANTS AND CARGO SHOULD NEVER EXCEED XXX kg OR XXX lb.”** for maximum payload. The payload listed on the Tire Label is the maximum payload for the vehicle as built by the assembly plant. If any aftermarket or authorized-dealer installed equipment has been installed on the vehicle, the weight of the equipment must be subtracted from the payload listed on the Tire Label in order to determine the new payload.

**WARNING:** The appropriate loading capacity of your vehicle can be limited either by volume capacity (how much space is available) or by payload capacity (how much weight the vehicle should carry). Once you have reached the maximum payload of your vehicle, do not add more cargo, even if there is space available. Overloading or improperly loading your vehicle can contribute to loss of vehicle control and vehicle rollover.



## Tires, Wheels and Loading

Example only:

TIRE AND LOADING INFORMATION			
SEATING CAPACITY		TOTAL 5	FRONT 2   REAR 3
The combined weight of occupants and cargo should never exceed : <b>XXX kg or XXX lbs.</b>			
TIRE	SIZE	COLD TIRE PRESSURE	SEE OWNERS MANUAL FOR ADDITIONAL INFORMATION
FRONT	LT225/75R 16.5E	200 KPA, 29 PSI	
REAR	LT225/75R 16.5E	200 KPA, 29 PSI	
SPARE	T145/80D16 P225/60R17	420 KPA, 60 PSI 200 KPA, 29 PSI	

TIRE AND LOADING INFORMATION			
RENSEIGNEMENTS SUR LES PNEUS ET LE CHARGEMENT			
SEATING CAPACITY		TOTAL 5	FRONT 2   REAR 3
NOMBRE DE PLACES		AVANT 2	ARRIÈRE 3
The combined weight of occupants and cargo should never exceed 492 kg or 1085 lbs. Le poids total des occupants et du chargement ne doit jamais dépasser 492 kg ou 1085 lb.			
TIRE PNEU	SIZE DIMENSIONS	COLD TIRE PRESSURE PRESSION DES PNEUS A FROID	SEE OWNER'S MANUAL FOR ADDITIONAL INFORMATION  VOIR LE MANUEL DE L'USAGER POUR PLUS DE RENSEIGNEMENTS
FRONT AVANT	P235/70R16	240 KPA, 35 PSI	
REAR ARRIÈRE	P235/70R16	240 KPA, 35 PSI	
SPARE DE SECOURS	T145/90R17	415 KPA, 60 PSI	

CARGO =



+

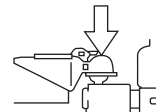

**Cargo Weight** – includes all weight added to the Base Curb Weight, including cargo and optional equipment. When towing, trailer tongue load or king pin weight is also part of cargo weight.

**GAW (Gross Axle Weight)** – is the total weight placed on each axle (front and rear) – including vehicle curb weight and all payload.

## Tires, Wheels and Loading

**GAWR (Gross Axle Weight Rating)** – is the maximum allowable weight that can be carried by a single axle (front or rear). **These numbers are shown on the Safety Compliance Certification Label located on the B-Pillar or the edge of the driver's door. The total load on each axle must never exceed its GAWR.**

**Note:** For trailer towing information refer to *Trailer towing* found in this chapter or the *RV and Trailer Towing Guide* provided by your authorized dealer.

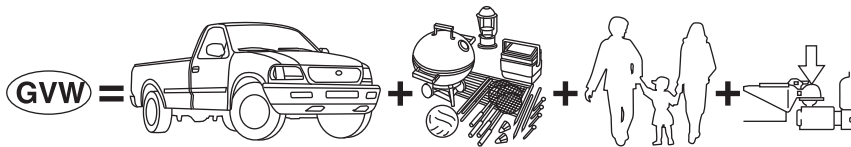

**GVW (Gross Vehicle Weight)** – is the Vehicle Curb Weight + cargo + passengers.

**GVWR (Gross Vehicle Weight Rating)** – is the maximum allowable weight of the fully loaded vehicle (including all options, equipment, passengers and cargo). **The GVWR is shown on the Safety Compliance Certification Label located on the B-Pillar or the edge of the driver's door. The GVW must never exceed the GVWR.**

## Tires, Wheels and Loading

- Example only:

**MFD. BY FORD MOTOR CO.**

DATE: XX/XX      GVWR: XXXXXLB/ XXXXXKG  
 FRONT GAWR: XXXXL      WITH REAR GAWR: XXXXLB  
 XXXXKG      WITH XXXXKG      WITH  
 XXXX/XXXXXXX      TIRES: XXXX/XXXXXXX      TIRES  
 XXXX,XX      RIMS: XXXX,XX      RIMS  
 AT XXX kPa/XX      PSI COLD      AT XXX kPa/XX      PSI COLD

THIS VEHICLE CONFORMS TO ALL APPLICABLE FEDERAL MOTOR  
 VEHICLE SAFETY AND THEFT PREVENTION STANDARDS IN  
 EFFECT ON THE DATE OF MANUFACTURE SHOWN ABOVE.

VIN: XXXXXXXXXXXXXXXX      XXXXX  
 TYPE: XXX      XXXXX



EXT PNT: XX      RC: XX      DSO:  
 WB BRK INT TR TP/PS R AXLE TR SPR XXXX  
 XXX X XX X XX X XX XXX  
 XXXXXXXXXXXXX XXX XXXX-XXXXXX-XX

**MFD. BY FORD MOTOR CO.**

DATE: xx/xx      GVWR/PNBV: xxxxx LB/xxxxxKG  
 FRONT GAWR/PNBE AV / REAR GAWR/ PNBE AR  
 xxxxx/xxxxxB      xxxxxKG/xxxxxB  
 WITH/AVEC TIRES/PNEUS  
 xxxxx/xxxxx  
 xxxxx/xxxxx  
 xxx,xxx      RIMS/JANTES xxx,xxx

AT/A kPa/PSI/LPC xxx/xx      COLD/A FROID xxx/xx  
 /JUMEELES

VIN: xxxxxxxxxxxxxxxx      xxxxxx  
 TYPE: xxx/xxxx      COMPLIES:xxxx/xxx-xxx      xxxxxx  
 xxxxxx



EXT PNT: UJ      RC: xx      DSO:  
 WB INT TR TP/PS R AXLE TR SPR xxxxxx  
 xxx xx x xx x xxxx xxx  
 XXXXXXXXXXXXX XXX XXXX-XXXXXX-XX



**WARNING:** Exceeding the Safety Compliance Certification Label vehicle weight rating limits could result in substandard vehicle handling or performance, engine, transmission and/or structural damage, serious damage to the vehicle, loss of control and personal injury.

## Tires, Wheels and Loading



**GCW (Gross Combined Weight)** – is the weight of the loaded vehicle (GVW) plus the weight of the fully loaded trailer.

**GCWR (Gross Combined Weight Rating)** – is the maximum allowable weight of the vehicle and the loaded trailer – including all cargo and passengers – that the vehicle can handle without risking damage. (Important: The towing vehicle's braking system is rated for operation at GVWR, not at GCWR.) Separate functional brakes should be used for safe control of towed vehicles and for trailers where the GCW of the towing vehicle plus the trailer exceed the GVWR of the towing vehicle. **The GCW must never exceed the GCWR.**

**Maximum Loaded Trailer Weight** – is the highest possible weight of a fully loaded trailer the vehicle can tow. It assumes a vehicle with only mandatory options, no cargo (internal or external), a tongue load of 10–15% (conventional trailer) or king pin weight of 15–25% (fifth wheel trailer), and driver only (150 lb. [68 kg]). **Consult your authorized dealer (or the *RV and Trailer Towing Guide* provided by your authorized dealer) for more detailed information.**

**Tongue Load or Fifth Wheel King Pin Weight** – refers to the amount of the weight that a trailer pushes down on a trailer hitch.

**Examples:** For a 5,000 lb. (2,268 kg) conventional trailer, multiply 5,000 by 0.10 and 0.15 to obtain a proper tongue load range of 500 to 750 lb. (227 to 340 kg). For an 11,500 lb. (5,216 kg) fifth wheel trailer, multiply by 0.15 and 0.25 to obtain a proper king pin load range of 1,725 to 2,875 lb. (782 to 1,304 kg)



**WARNING:** Do not exceed the GVWR or the GAWR specified on the Safety Compliance Certification Label.

## Tires, Wheels and Loading



**WARNING:** Do not use replacement tires with lower load carrying capacities than the original tires because they may lower the vehicle's GVWR and GAWR limitations. Replacement tires with a higher limit than the original tires do not increase the GVWR and GAWR limitations.



**WARNING:** Exceeding any vehicle weight rating limitation could result in serious damage to the vehicle and/or personal injury.

### Steps for determining the correct load limit:

1. Locate the statement "The combined weight of occupants and cargo should never exceed XXX kg or XXX lb." on your vehicle's placard.
2. Determine the combined weight of the driver and passengers that will be riding in your vehicle.
3. Subtract the combined weight of the driver and passengers from XXX kg or XXX lb.
4. The resulting figure equals the available amount of cargo and luggage load capacity. For example, if the "XXX" amount equals 1,400 lb. and there will be five 150 lb. passengers in your vehicle, the amount of available cargo and luggage load capacity is 650 lb. ( $1400 - 750 (5 \times 150) = 650$  lb.). In metric units ( $635 - 340 (5 \times 68) = 295$  kg.)
5. Determine the combined weight of luggage and cargo being loaded on the vehicle. That weight may not safely exceed the available cargo and luggage load capacity calculated in Step 4.
6. If your vehicle will be towing a trailer, load from your trailer will be transferred to your vehicle. Consult this manual to determine how this reduces the available cargo and luggage load capacity of your vehicle.

The following gives you a few examples on how to calculate the available amount of cargo and luggage load capacity:

- Another example for your vehicle with 1,400 lb. (635 kg) of cargo and luggage capacity. You decide to go golfing. Is there enough load capacity to carry you, 4 of your friends and all the golf bags? You and four friends average 220 lb. (99 kg) each and the golf bags weigh approximately 30 lb. (13.5 kg) each. The calculation would be:  
 $1400 - (5 \times 220) - (5 \times 30) = 1400 - 1100 - 150 = 150$  lb. Yes, you have enough load capacity in your vehicle to transport four friends and your golf bags. In metric units, the calculation would be:  
 $635 \text{ kg} - (5 \times 99 \text{ kg}) - (5 \times 13.5 \text{ kg}) = 635 - 495 - 67.5 = 72.5$  kg.

## Tires, Wheels and Loading

- A final example for your vehicle with 1,400 lb. (635 kg) of cargo and luggage capacity. You and one of your friends decide to pick up cement from the local home improvement store to finish that patio you have been planning for the past 2 years. Measuring the inside of the vehicle with the rear seat folded down, you have room for 12-100 lb. (45 kg) bags of cement. Do you have enough load capacity to transport the cement to your home? If you and your friend each weigh 220 lb. (99 kg), the calculation would be:  $1400 - (2 \times 220) - (12 \times 100) = 1400 - 440 - 1200 = -240$  lb. No, you do not have enough cargo capacity to carry that much weight. In metric units, the calculation would be:  $635 \text{ kg} - (2 \times 99 \text{ kg}) - (12 \times 45 \text{ kg}) = 635 - 198 - 540 = -103$  kg. You will need to reduce the load weight by at least 240 lb. (104 kg). If you remove 3-100 lb. (45 kg) cement bags, then the load calculation would be:

$1400 - (2 \times 220) - (9 \times 100) = 1400 - 440 - 900 = 60$  lb. Now you have the load capacity to transport the cement and your friend home. In metric units, the calculation would be:  $635 \text{ kg} - (2 \times 99 \text{ kg}) - (9 \times 45 \text{ kg}) = 635 - 198 - 405 = 32$  kg.

The above calculations also assume that the loads are positioned in your vehicle in a manner that does not overload the Front or the Rear Gross Axle Weight Rating specified for your vehicle on the Safety Compliance Certification Label found on the edge of the driver's door.

### Special loading instructions for owners of pick-up trucks and utility-type vehicles



**WARNING:** For important information regarding safe operation of this type of vehicle, see the *Preparing to drive your vehicle* section in the *Driving* chapter of this owner's guide.



**WARNING:** Loaded vehicles, with a higher center of gravity, may handle differently than unloaded vehicles. Extra precautions, such as slower speeds and increased stopping distance, should be taken when driving a heavily loaded vehicle.

Your vehicle has the capability to haul more cargo and people than most passenger cars. Depending upon the type and placement of the load, hauling cargo and people may raise the center of gravity of the vehicle.

## Tires, Wheels and Loading

### TRAILER TOWING

Trailer towing puts additional loads on your vehicle's engine, transmission, axle, brakes, tires and suspension. For your safety and to maximize vehicle performance, be sure to use the proper equipment while towing.

Follow these guidelines to ensure safe towing:

- Do not tow a trailer until your vehicle has been driven at least 500 miles (800 km). Additionally, during the first 500 miles (800 km) that you tow a trailer, do not drive over 70 mph (113 km/h) and do not make starts at full throttle.
- Consult your local motor vehicle laws for towing a trailer.
- Refer to the instructions included with towing accessories for the proper installation and adjustment specifications.
- Thoroughly prepare your vehicle for towing. Refer to *Preparing to tow* in this chapter.
- Stay within your vehicle's load limits. If exceeded, cargo should be removed from the trailer and/or the vehicle until all weights are within specified limits.
- Use extra caution when driving while trailer towing. Refer to *Driving while you tow* in this chapter.
- Service your vehicle more frequently if you tow a trailer. Refer to *Special operating conditions* in the *Scheduled Maintenance Guide* chapter.

#### **Trailer towing (standard equipment):**

Your vehicle is equipped with an integrated trailer hitch and a Class I (4-pin) trailer electrical connector. The 4-pin connector supplies power to tail lamps, stop lamps, and turn lamps. See the trailer towing chart for the trailer towing weight recommendation.

#### **Trailer towing (optionally equipped trailer tow package):**

The optional trailer tow package includes heavy duty trailer tow wiring. Both a Class I (4-pin) and IV (7-pin) trailer electrical connector are provided. Under the instrument panel a electrical connector is provided for a customer supplied aftermarket electronic brake controller. For installing a customer supplied electronic brake controller, a electrical jumper harness and trailer tow electrical instructions are included with the optional trailer tow package.

The kit containing a electrical jumper and trailer tow electrical instructions may be purchased from any authorized dealer (part number 4L1Z-14A348-AA).

## Tires, Wheels and Loading

**Note:** Before towing a trailer, make sure the trailer brakes (if equipped) and lamps are properly connected and functional. If equipped with electronic trailer brakes, refer to the instructions provided by the aftermarket electronic brake controller manufacturer for determining trailer brake functionality.

Engine/Tow Package	Maximum GCWR - lb (kg)	Maximum Trailer Weight - lb (kg)
<b>4x2</b>		
5.4L/Standard	11800 (5352)	6000 (2721)
5.4L/Optional	15000 (6804)	9200 (4172)
<b>4x2 EL (U.S. only)/Max (Canada only)</b>		
5.4L/Standard	12100 (5488)	6000 (2721)
5.4L/Optional	15000 (6804)	8900 (4037)
<b>4x4</b>		
5.4L/Standard	12000 (5443)	6000 (2721)
5.4L/Optional	15000 (6804)	9000 (4082)
<b>4x4 EL (U.S. only)/Max (Canada only)</b>		
5.4L/Standard	12300 (5579)	6000 (2721)
5.4L/Optional	15000 (6804)	8700 (3946)
<p><b>Note:</b> For vehicles with the standard trailer tow package, the maximum frontal area of trailer should not exceed 36.5 ft<sup>2</sup> (3.4 m<sup>2</sup>). For vehicles equipped with the optional trailer tow package, the maximum frontal area of trailer should not exceed 60 ft<sup>2</sup> (5.6 m<sup>2</sup>).</p>		

For load specification terms found on the label, refer to *Vehicle loading - with and without a trailer* in this chapter. Remember to figure in the tongue load of your loaded trailer when figuring the total weight.



**WARNING:** Towing trailers beyond the maximum recommended gross trailer weight exceeds the limit of the vehicle and could result in engine damage, transmission damage, structural damage, loss of control, vehicle rollover and personal injury.

### Preparing to tow

Use the proper equipment for towing a trailer and make sure it is properly attached to your vehicle. Contact your authorized dealer or a reliable trailer dealer as soon as possible if you require assistance.



## Tires, Wheels and Loading

### Hitches

Do not use hitches that clamp onto the vehicle bumper; use a load-carrying hitch. You must distribute the load in your trailer so that 10–15% of the total weight of the trailer is on the tongue.



**WARNING:** The trailer hitch on this vehicle is part of the vehicle rear crash safety structure. Do not remove the trailer hitch. Failure to follow this warning could compromise vehicle crash structure and increase the risk of injury in a rear end collision.

### Integrated hitch rating

The standard integrated hitch has two ratings depending on mode of operation:

- **Weight-carrying** - requires a draw bar and hitch ball. The draw bar supports all the vertical tongue load of the trailer.
- **Weight-distributing** - requires an aftermarket weight-distributing system which includes draw bar, hitch ball, spring bars and snap-up brackets. The vertical tongue load of the trailer is distributed between the truck and the trailer by this system.

Mode	Maximum Trailer Weight - lb (kg)	Maximum Tongue Weight - lb (kg)
Weight-carrying	6000 (2721)	600 (272)
Weight-distributing	9200 (4173)	920 (417)

These are hitch ratings only; actual vehicle ratings are dependent on engine, transmission and axle combinations.



**WARNING:** Towing trailers beyond the maximum tongue weight exceeds the limit of the towing system and could result in vehicle structural damage, loss of vehicle control and personal injury.

### Weight-distributing hitch

When hooking-up a trailer using a load-equalizing hitch, always use the following procedure:

1. Park the unloaded vehicle on a level surface. With the ignition in the on position and all doors closed, allow the vehicle to stand (without passengers) for several minutes so that it can level.
2. Turn the air suspension (if equipped) control to off.
3. Measure the height of a reference point on the front and rear bumpers at the center of the vehicle.

## Tires, Wheels and Loading

4. Attach the trailer to the vehicle and adjust the hitch equalizers so that the front bumper height is within a ½ in. (13 mm) of the reference point. After proper adjustment, the rear bumper should be no higher than in Step 3.
5. Turn the air suspension (if equipped) control to on.



**WARNING:** Do not adjust a weight-distributing hitch to any position where the rear bumper of the vehicle is higher than it was before attaching the trailer. Doing so will defeat the function of the weight-distributing hitch, which may cause unpredictable handling, and could result in serious personal injury.

### Safety chains

Always connect the trailer's safety chains to the frame or hook retainers of the vehicle hitch. To connect the trailer's safety chains, cross the chains under the trailer tongue and allow slack for turning corners.

If you use a rental trailer, follow the instructions that the rental agency gives to you.

**Do not attach safety chains to the bumper.**

### Trailer brakes

Electric brakes and manual, automatic or surge-type trailer brakes are safe if installed properly and adjusted to the manufacturer's specifications. The trailer brakes must meet local and Federal regulations.



**WARNING:** Do not connect a trailer's hydraulic brake system directly to your vehicle's brake system. Your vehicle may not have enough braking power and your chances of having a collision greatly increase.

The braking system of the tow vehicle is rated for operation at the GVWR not GCWR.

### Trailer lamps

Trailer lamps are required on most towed vehicles. Make sure all running lights, brake lights, turn signals and hazard lights are working. Contact your authorized dealer or trailer rental agency for proper instructions and equipment for hooking-up trailer lamps.

### Driving while you tow

When towing a trailer:

- Do not drive faster than 70 mph (113 km/h) during the first 500 miles (800 km) of trailer towing and don't make full-throttle starts.

## Tires, Wheels and Loading

- Turn off the speed control. The speed control may shut off automatically when you are towing on long, steep grades.
- Activate the tow/haul feature to eliminate excessive transmission shifting and assist in transmission cooling. For additional information, refer to *Automatic transmission operation* in the *Driving* chapter.
- Allow more distance for stopping with a trailer attached; anticipate stops and brake gradually.

If your vehicle is equipped with AdvanceTrac® with RSC, you may experience AdvanceTrac® with RSC activations during typical cornering maneuvers with a heavily loaded trailer; this is normal. Cornering at a slower speed while towing will reduce the tendency of the AdvanceTrac® stability enhancement system to activate.

### **Servicing after towing**

If you tow a trailer for long distances, your vehicle will require more frequent service intervals. Refer to *Special operating conditions* in the *Scheduled Maintenance Guide* chapter.

### **Trailer towing tips**

- Practice turning, stopping and backing-up before starting on a trip to get the feel of the vehicle-trailer combination. When turning, make wider turns so the trailer wheels will clear curbs and other obstacles.
- To aid in engine/transmission cooling and A/C efficiency during hot weather while stopped in traffic, place the gearshift lever in P (Park).
- After you have traveled 50 miles (80 km), thoroughly check your hitch, electrical connections and trailer wheel lug nuts.
- If you are driving down a long or steep hill, shift to a lower gear. Do not apply the brakes continuously, as they may overheat and become less effective.
- If you will be towing a trailer frequently in hot weather, hilly conditions, at GCWR, or any combination of these factors, consider refilling your rear axle with synthetic gear lube if not already so equipped. Refer to the *Maintenance and Specifications* chapter for the lubricant specification. Remember that regardless of the rear axle lube used, do not tow a trailer for the first 1,000 miles (1,600 km) of a new vehicle, and that the first 500 miles (800 km) of towing be done at no faster than 70 mph (113 km/h) with no full throttle starts.
- Vehicles with trailers should not be parked on a grade. If you must park on a grade, place wheel chocks under the trailer's wheels.

## Tires, Wheels and Loading

### Launching or retrieving a boat

**Disconnect the wiring to the trailer before backing the trailer into the water. Reconnect the wiring to the trailer after the trailer is removed from the water.**

When backing down a ramp during boat launching or retrieval:

- Do not allow the static water level to rise above the bottom edge of the rear bumper.
- Do not allow waves to break higher than 6 in (15 cm) above the bottom edge of the rear bumper.

Exceeding these limits may allow water to enter vehicle components:

- Causing internal damage to the components.
- Affecting driveability, emissions and reliability.

Replace the rear axle lubricant any time the axle has been submerged in water. Rear axle lubricant quantities are not to be checked or changed unless a leak is suspected or repair required.

### RECREATIONAL TOWING

Follow these guidelines if you have a need for recreational towing. An example of recreational towing would be towing your vehicle behind a motorhome. These guidelines are designed to ensure that your transmission is not damaged.

**Note:** Put your climate control system in recirculated air mode to prevent exhaust fumes from entering the vehicle. Refer to the *Climate Controls* chapter for more information.

**2WD and 4WD vehicles:** Do not tow your vehicle with any wheels on the ground, as vehicle or transmission damage may occur. It is recommended to tow your vehicle with all four (4) wheels off the ground such as when using a car-hauling trailer. Otherwise, no recreational towing is permitted. See your authorized dealer if you must flat-tow a vehicle equipped with the Control Trac® 4WD system.

In case of a roadside emergency with a disabled vehicle, see *Wrecker towing* in the *Roadside Emergencies* chapter.

### STARTING

#### Positions of the ignition

1. Off— locks the steering wheel, automatic transmission gearshift lever and allows key removal.
2. Accessory— allows the electrical accessories such as the radio to operate while the engine is not running.
3. On— all electrical circuits operational. Warning lights illuminated. Key position when driving.
4. Start— cranks the engine. Release the key once the engine starts.

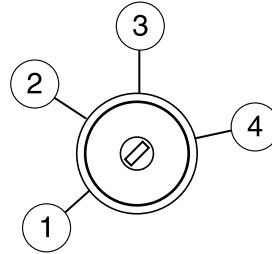

#### Preparing to start your vehicle

Engine starting is controlled by the powertrain control system.

This system meets all Canadian interference-causing equipment standard requirements regulating the impulse electrical field strength of radio noise.

When starting a fuel-injected engine, avoid pressing the accelerator before or during starting. Only use the accelerator when you have difficulty starting the engine. For more information on starting the vehicle, refer to *Starting the engine* in this chapter.



**WARNING:** Extended idling at high engine speeds can produce very high temperatures in the engine and exhaust system, creating the risk of fire or other damage.



**WARNING:** Do not park, idle, or drive your vehicle in dry grass or other dry ground cover. The emission system heats up the engine compartment and exhaust system, which can start a fire.



**WARNING:** Do not start your vehicle in a closed garage or in other enclosed areas. Exhaust fumes can be toxic. Always open the garage door before you start the engine. See *Guarding against exhaust fumes* in this chapter for more instructions.

## Driving



**WARNING:** If you smell exhaust fumes inside your vehicle, have your dealer inspect your vehicle immediately. Do not drive if you smell exhaust fumes.

### ***Important safety precautions***

A computer system controls the engine's idle revolutions per minute (RPM). When the engine starts, the idle RPM runs higher than normal in order to warm the engine. If the engine idle speed does not slow down automatically, have the vehicle checked. Do not allow the vehicle to idle for more than 10 minutes at the higher engine RPM.

Before starting the vehicle:

1. Make sure all vehicle occupants have buckled their safety belts. For more information on safety belts and their proper usage, refer to the *Seating and Safety Restraints* chapter.
2. Make sure the headlamps and vehicle accessories are off.
3. Make sure the gearshift is in P (Park).

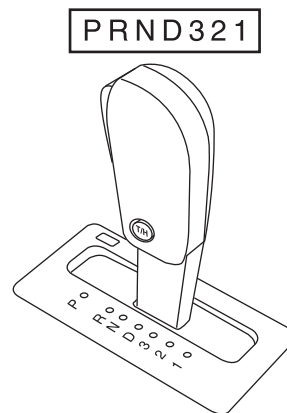

## Driving

4. Make sure the parking brake is set.

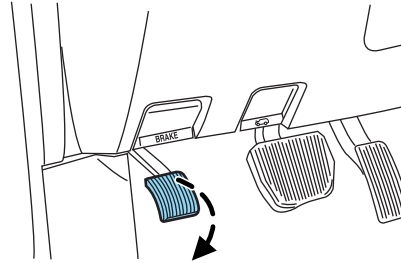

5. Turn the key to 3 (on) without turning the key to 4 (start).

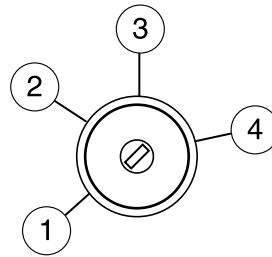

Some warning lights will briefly illuminate. See *Warning lights and chimes* in the *Instrument Cluster* chapter for more information regarding the warning lights.

### Starting the engine

1. Turn the key to 3 (on) without turning the key to 4 (start).
2. Turn the key to 4 (start), then release the key as soon as the engine begins cranking. Your vehicle has a computer assisted cranking system that assists in starting the engine. After releasing the key from the 4 (start) position, the engine may continue cranking for up to 10 seconds or until the vehicle starts.

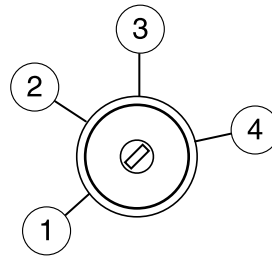

**Note:** Cranking may be stopped at any time by turning the key to the off position.

## Driving

3. After idling for a few seconds, release the parking brake, apply the brake, shift into gear and drive.

**Note:** If the engine does not start on the first try, turn the key to the off position, wait 10 seconds and try Step 2 again. If the engine still fails to start, press the accelerator to the floor and try Step 2 again, keeping the accelerator on the floor until the engine begins to accelerate above cranking speeds; this will allow the engine to crank with the fuel shut off in case the engine is flooded with fuel.

### **Cold weather starting (flexible fuel vehicles only)**

The starting characteristics of all grades of E<sub>85</sub> ethanol make it unsuitable for use when ambient temperatures fall below 0°F (-18°C). Consult your fuel distributor for the availability of winter grade ethanol. As the outside temperature approaches freezing, ethanol fuel distributors should supply winter grade ethanol (same as with unleaded gasoline). If summer grade ethanol is used in cold weather conditions, 0°F to 32°F (-18°C to 0°C), you may experience increased cranking times, rough idle or hesitation until the engine has warmed up.

You may experience a decrease in peak performance when the engine is cold when operating on E<sub>85</sub> ethanol.

Do not crank the engine for more than 10 seconds at a time as starter damage may occur. If the engine fails to start, turn the key to off and wait 30 seconds before trying again.

Do not use starting fluid such as ether in the air intake system. Such fluid could cause immediate explosive damage to the engine and possible personal injury.

If you should experience cold weather starting problems on E<sub>85</sub> ethanol, and neither an alternative brand of E<sub>85</sub> ethanol nor an engine block heater is available, the addition of unleaded gasoline to your tank will improve cold starting performance. Your vehicle is designed to operate on E<sub>85</sub> ethanol alone, unleaded gasoline alone, or any mixture of the two.

See *Choosing the right fuel* in the *Maintenance and Specifications* chapter for more information on ethanol.

### **If the engine fails to start using the preceding instructions (flexible fuel vehicles only)**

1. Press and hold down the accelerator 1/3 to 1/2 way to floor, then crank the engine.
2. When the engine starts, release the key, then gradually release the accelerator pedal as the engine speeds up. If the engine still fails to start, repeat Step 1.

240

<https://www.MyCarManual.com>



## Driving

### Guarding against exhaust fumes

Carbon monoxide is present in exhaust fumes. Take precautions to avoid its dangerous effects.



**WARNING:** If you smell exhaust fumes inside your vehicle, have your dealer inspect your vehicle immediately. Do not drive if you smell exhaust fumes.

### Important ventilating information

If the engine is idling while the vehicle is stopped for a long period of time, open the windows at least 1 inch (2.5 cm) or adjust the heating or air conditioning to bring in fresh air.

### ENGINE BLOCK HEATER (IF EQUIPPED)

If your vehicle is factory-equipped with an engine block heater, a rubber cap/plug assembly will be visibly attached to the grille on the front of the vehicle. This assembly is shipped in-vehicle for authorized dealer installation. If not factory-equipped, the engine block heater can be purchased through authorized dealer accessories.

Replacement rubber caps are available through an authorized dealer, 3L1Z-6E088-AA.

An engine block heater warms the engine coolant which aids in starting and allows the heater/defroster system to respond quickly. If your vehicle is equipped with this system, your equipment includes a heater element which is installed in your engine block and a wire harness which allows the user to connect the system to a grounded 120 volt A/C electrical source. The block heater system is most effective when outdoor temperatures reach below 0°F (-18°C).

For flexible fuel vehicles, if operating with E<sub>85</sub> ethanol, an engine block heater must be used if ambient temperature is below 0°F (-18°C).

See *Cold weather starting* earlier in this chapter for more information on starting with ethanol.

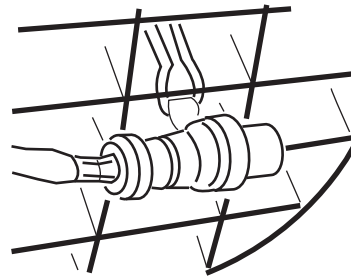

**WARNING:** Failure to follow engine block heater instructions could result in property damage or physical injury.

## Driving



**WARNING:** To reduce the risk of electrical shock, do not use your heater with ungrounded electrical systems or two-pronged (cheater) adapters.

Prior to using the engine block heater, follow these recommendations for proper and safe operation:

- For your safety, use an outdoor extension cord that is product certified by Underwriter's Laboratory (UL) or Canadian Standards Association (CSA). Use only an extension cord that can be used outdoors, in cold temperatures, and is clearly marked "Suitable for Use with Outdoor Appliances." Never use an indoor extension cord outdoors; it could result in an electric shock or fire hazard.
- Use a 16 gauge outdoor extension cord, minimum.
- Use as short an extension cord as possible.
- Do not use multiple extension cords. Instead, use one extension cord which is long enough to reach from the engine block heater cord to the outlet without stretching.
- Make certain that the extension cord is in excellent condition (not patched or spliced). Store your extension cord indoors at temperatures above 32°F (0°C). Outdoor conditions can deteriorate extension cords over a period of time.
- To reduce the risk of electrical shock, do not use your heater with ungrounded electrical systems or two pronged (cheater) adapters. Also ensure that the block heater, especially the cord, is in good condition before use.
- Make sure that when in operation, the extension cord plug /engine block heater cord plug connection is free and clear of water in order to prevent possible shock or fire.
- Be sure that areas where the vehicle is parked are clean and clear of all combustibles such as petroleum products, dust, rags, paper and similar items.
- Be sure that the engine block heater, heater cord and extension cord are solidly connected. A poor connection can cause the cord to become very hot and may result in an electrical shock or fire. Be sure to check for heat anywhere in the electrical hookup once the system has been operating for approximately a half hour.
- Finally, have the engine block heater system checked during your fall tune-up to be sure it's in good working order.

### How to use the engine block heater

Ensure the receptacle terminals are clean and dry prior to use. To clean them, use a dry cloth.

Depending on the type of factory installed equipment, your engine block heater system may consume anywhere between 400 watts or 1000 watts of power per hour. Your factory installed block heater system does not have a thermostat; however, maximum temperature is attained after approximately three hours of operation. Block heater operation longer than three hours will not improve system performance and will unnecessarily use additional electricity.

Make sure system is unplugged and properly stowed before driving the vehicle. While not in use, make sure the protective cover seals the prongs of the engine block heater cord plug.

### BRAKES

Your service brakes are self-adjusting. Refer to the *scheduled maintenance information* for scheduled maintenance.

Occasional brake noise is normal and often does not indicate a performance concern with the vehicle's brake system. In normal operation, automotive brake systems may emit occasional or intermittent squeal or groan noises when the brakes are applied. Such noises are usually heard during the first few brake applications in the morning; however, they may be heard at any time while braking and can be aggravated by environmental conditions such as cold, heat, moisture, road dust, salt or mud. If a "metal-to-metal," "continuous grinding" or "continuous squeal" sound is present while braking, the brake linings may be worn-out and should be inspected by an authorized dealer.

Refer to *Brake system warning light* in the *Warning lights and chimes* section of the *Instrument Cluster* chapter for information.

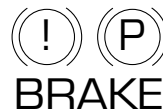

**WARNING:** If you are driving down a long or steep hill, shift to a lower gear. Do not apply your brakes continuously, as they may overheat and become less effective.

## Driving

### Anti-lock brake system (ABS)

On ABS-equipped vehicles, a noise from the hydraulic pump motor and pulsation in the pedal may be observed during ABS braking events. Pedal pulsation coupled with noise while braking under panic conditions or on loose gravel, bumps, wet or snowy roads is normal and indicates proper functioning of the vehicle's anti-lock brake system. The ABS performs a self-check after you start the engine and begin to drive away. A brief mechanical noise may be heard during this test. This is normal. If a malfunction is found, the ABS warning light will come on. If the vehicle has continuous vibration or shudder in the steering wheel while braking, the vehicle should be inspected by an authorized dealer.

The ABS operates by detecting the onset of wheel lockup during brake applications and compensates for this tendency. The wheels are prevented from locking even when the brakes are firmly applied.

### Using ABS

- In an emergency or when maximum efficiency from the four-wheel ABS is required, apply continuous force on the brake. The four-wheel ABS will be activated immediately, thus allowing you to retain steering control of your vehicle and, providing there is sufficient space, will enable you to avoid obstacles and bring the vehicle to a controlled stop.
- The anti-lock system does not always reduce stopping distance. Always leave enough room between your vehicle and the vehicle in front of you to stop.
- We recommend that you familiarize yourself with this braking technique. However, avoid taking any unnecessary risks.

### ABS warning lamp

The ABS warning lamp in the instrument cluster momentarily illuminates when the ignition is turned on. If the light does not illuminate momentarily at start up, remains on or continues to flash, the ABS needs to be serviced.

With the ABS light on, the anti-lock brake system is disabled and normal braking is still effective unless the brake warning light also remains illuminated with parking brake released. If your brake warning lamp illuminates, have your vehicle serviced immediately.

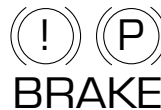

## Driving

### Parking brake

Apply the parking brake whenever the vehicle is parked. To set the parking brake, press the parking brake pedal down until the pedal stops.

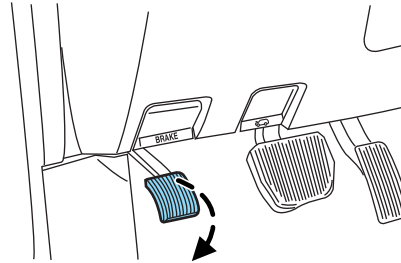

The BRAKE warning lamp in the instrument cluster illuminates and remains illuminated (when the ignition is turned on) until the parking brake is released.



 **WARNING:** If the parking brake is fully released, but the brake warning lamp remains illuminated, the brakes may not be working properly. See your authorized dealer.

 **WARNING:** Always set the parking brake fully and make sure that the gearshift is securely latched in P (Park).

The parking brake is not recommended to stop a moving vehicle. However, if the normal brakes fail, the parking brake can be used to stop your vehicle in an emergency. Since the parking brake applies only the rear brakes, the vehicle's stopping distance will increase greatly and the handling of your vehicle will be adversely affected.

## Driving

Pull the release lever to release the brake. Driving with the parking brake on will cause the brakes to wear out quickly and reduce fuel economy.

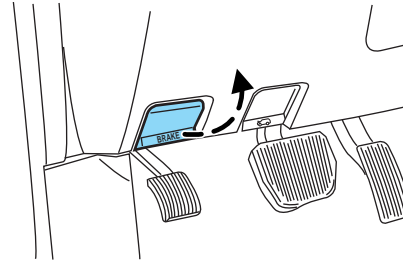

### **ADVANCETRAC® WITH ROLL STABILITY CONTROL™ (RSC®) STABILITY ENHANCEMENT SYSTEM (IF EQUIPPED)**

The AdvanceTrac® with RSC® system provides the following stability enhancement features for certain driving situations:

- Traction control system (TCS), which functions to help avoid drive-wheel spin and loss of traction.
- Electronic stability control (ESC), which functions to help avoid skids or lateral slides.
- Roll Stability Control™ (RSC®), which functions to help avoid a vehicle roll-over.



**WARNING:** Vehicle modifications involving braking system, aftermarket roof racks, suspension, steering system, tire construction and/or wheel/tire size may change the handling characteristics of the vehicle and may adversely affect the performance of the AdvanceTrac® with RSC® system. In addition, installing any stereo loudspeakers may interfere with and adversely affect the AdvanceTrac® with RSC® system. Install any aftermarket stereo loudspeaker as far as possible from the front center console, the tunnel, and the front seats in order to minimize the risk of interfering with the AdvanceTrac® with RSC® sensors. Reducing the effectiveness of the AdvanceTrac® with RSC® system could lead to an increased risk of loss of vehicle control, vehicle rollover, personal injury and death.

## Driving

 **WARNING:** Remember that even advanced technology cannot defy the laws of physics. It's always possible to lose control of a vehicle due to inappropriate driver input for the conditions. Aggressive driving on any road condition can cause you to lose control of your vehicle increasing the risk of personal injury or property damage. Activation of the AdvanceTrac<sup>®</sup> with RSC<sup>®</sup> system is an indication that at least some of the tires have exceeded their ability to grip the road; this could reduce the operator's ability to control the vehicle, potentially resulting in a loss of vehicle control, vehicle rollover, personal injury and death. If your AdvanceTrac<sup>®</sup> with RSC<sup>®</sup> system activates, SLOW DOWN.

 **WARNING:** If a failure has been detected within the AdvanceTrac<sup>®</sup> with RSC<sup>®</sup> system, the stability control light will illuminate steadily. Verify that the AdvanceTrac<sup>®</sup> with RSC<sup>®</sup> system is not manually disabled (press the stability control button located on the center of the instrument panel). If the stability control light still illuminates steadily, have the system serviced by an authorized dealer immediately. Operating your vehicle with AdvanceTrac<sup>®</sup> with RSC<sup>®</sup> disabled could lead to an increased risk of loss of vehicle control, vehicle rollover, personal injury and death.

The AdvanceTrac<sup>®</sup> with RSC<sup>®</sup> system automatically enables each time the engine is started. All features of the AdvanceTrac<sup>®</sup> with RSC<sup>®</sup> system (TCS, ESC, and RSC<sup>®</sup> are active and monitor the vehicle from start-up). However, the system will only intervene if the driving situation requires it.

The AdvanceTrac<sup>®</sup> with RSC<sup>®</sup> system includes a stability control button on the center of the instrument panel, and a stability control light in the instrument cluster. The stability control light in



the instrument cluster will illuminate temporarily during start-up as part of a normal system self-check, or during driving if a driving situation causes the AdvanceTrac<sup>®</sup> with RSC<sup>®</sup> system to operate. If the stability control light illuminates steadily, verify that the AdvanceTrac<sup>®</sup> with RSC<sup>®</sup> system is not manually disabled by pressing the stability control button located on the center of the instrument panel. If the stability control light remains steadily illuminated, have the system serviced by an authorized dealer immediately. The message center will also indicate a failure with the AdvanceTrac<sup>®</sup> with RSC<sup>®</sup> system.

## Driving

**Note:** If the system cannot be turned off, refer to *MyKey™* in the *Locks and Security* chapter for more information.

When AdvanceTrac® with RSC® performs a normal system self-check, some drivers may notice a slight movement of the brake, and/or a rumble, grunting, or grinding noise after startup and when driving off.

When an event occurs that activates AdvanceTrac® with RSC® you may experience the following:

- A slight deceleration of the vehicle
- The stability control light will flash.
- A vibration in the pedal when your foot is on the brake pedal.
- If the driving condition is severe and your foot is not on the brake, the brake pedal may move as the systems applies higher brake forces. You may also hear a whoosh of air from under the instrument panel during this severe condition.
- The brake pedal may feel stiffer than usual.

### **Traction control system (TCS)**

The TCS is a driver aid feature that helps your vehicle maintain traction of the wheels, typically when driving on slippery and/or hilly road surfaces, by detecting and controlling wheel spin.

Excessive wheel spin is controlled in two ways, which may work separately or in tandem: engine traction control and brake traction control. Engine traction control works to limit drive-wheel spin by momentarily reducing engine power. Brake traction control works to limit wheel spin by momentarily applying the brakes to the wheel that is slipping. Traction control is most active at low speeds.

During TCS events, the stability control light in the instrument cluster will flash.

If the TCS system is activated excessively in a short period of time, the braking portion of the system may become temporarily disabled to allow the brakes to cool down. In this situation, TCS will use only engine power reduction or transfer to help control the wheels from over-spinning. When the brakes have cooled down, the system will regain all features. Anti-lock braking, RSC®, and ESC are not affected by this condition and will continue to function during the cool-down period.

The engine traction control and brake traction control system may be deactivated in certain situations. See the *Switching off traction control* section following.



### **Electronic stability control (ESC)**

Electronic stability control (ESC) may enhance your vehicle's directional stability during adverse maneuvers, for example when cornering severely or avoiding objects in the roadway. ESC operates by applying brakes to one or more of the wheels individually and, if necessary, reducing engine power if the system detects that the vehicle is about to skid or slide laterally.

During ESC events, the stability control light in the instrument cluster will flash.

Certain adverse driving maneuvers may activate the ESC system, which include but are not limited to:

- Taking a turn too fast
- Maneuvering quickly to avoid an accident, pedestrian or obstacle
- Driving over a patch of ice or other slippery surfaces
- Changing lanes on a snow-rutted road
- Entering a snow-free road from a snow-covered side street, or vice versa
- Entering a paved road from a gravel road, or vice versa
- Cornering while towing a heavily loaded trailer (refer to *Trailer towing* in the *Tires, Wheels and Loading* chapter).

### **Roll Stability Control™ (RSC®)**

Roll Stability Control™ (RSC®) may help to maintain roll stability of the vehicle during adverse maneuvers. RSC® operates by detecting the vehicle's roll motion and the rate at which it changes and by applying the brakes to one or more wheels individually.

During an event that activates the RSC® system, the stability control light in the instrument cluster will flash.

Certain adverse driving maneuvers may activate the Roll Stability Control system, which include:

- Emergency lane-change
- Taking a turn too fast
- Quick maneuvering to avoid an accident, pedestrian or obstacle

### **Switching off traction control**

If the vehicle is stuck in snow, mud or sand, and seems to lose engine power, switching off the traction control features of the AdvanceTrac® with RSC® system may be beneficial because the wheels are allowed to

## Driving

spin. This will restore full engine power and will enhance momentum through the obstacle. To switch off the traction control, press the stability control button. Full features of the AdvanceTrac® with RSC® system can be restored by pressing the stability control button again or by turning off and restarting the engine.

If you switch off the traction control, the stability control light will illuminate steadily. Pressing the stability control button again will turn off the stability control light.

In 4L (4X4 Low) if equipped, ABS and the brake traction control features will continue to function; however ESC, RSC and engine traction control are disabled.

In R (Reverse), ABS and the engine traction control and brake traction control features will continue to function; however, ESC and RSC® are disabled.

AdvanceTrac® with RSC® Features					
Button functions	Stability control light 	RSC®	ESC	Engine traction control	Brake traction control
Default at start-up	Illuminated during bulb check	Enabled	Enabled	Enabled	Enabled
Button pressed momentarily	Illuminated solid	Enabled	Enabled	Partially enabled	Partially enabled

### Trailer sway control

Your vehicle may be equipped with trailer sway control. When properly equipped, trailer sway control will use the vehicle's AdvanceTrac® with RSC® system to detect and help reduce trailer sway by applying brake force at individual wheels and, if necessary, by reducing engine power.



**WARNING:** Trailer sway control does not prevent a trailer from swaying, it mitigates the sway from increasing once it has occurred. If you are experiencing trailer sway it is likely that the trailer is improperly loaded for the correct tongue weight or the speed of the vehicle and trailer is too high. Pull the vehicle-trailer over to a safe location to check the trailer weight distribution and tongue load and reduce speed to a safe level while towing. If trailer sway is experienced, SLOW DOWN.

## Driving

During trailer sway control events, the stability control light in the instrument cluster will flash momentarily. The cluster message center will also display TRAILER SWAY REDUCE SPEED. In some cases when trailer sway is detected, the vehicle speed is too high and may be above a speed at which trailer sway will not grow continuously. This may cause the system to activate multiple times, causing a gradual reduction in speed.

**Note:** The trailer sway control will only activate at speeds greater than 40 mph (64 km/h).

### Disabling trailer sway control

Trailer sway control can be disabled during any key cycle. See *Message center* in the *Instrument Cluster* chapter. Note that regardless of chosen enable state, trailer sway control will be re-enabled at each new key cycle.



**WARNING:** Turning off trailer sway control increases the risk of loss of vehicle control, serious injury, or death. Ford does not recommend disabling this feature except in situations where speed reduction may be detrimental (e.g., hill climbing), the driver has significant trailer towing experience, and can control trailer sway and maintain safe operation.

## STEERING

Your vehicle is equipped with power steering. Power steering uses energy from the engine to decrease the driver's effort in steering the vehicle.

To help prevent damage to the power steering pump:

- Never hold the steering wheel to the extreme right or the extreme left for more than a few seconds when the engine is running.
- Do not operate the vehicle with the power steering pump fluid level below the MIN mark on the reservoir.
- Some noise is normal during operation. If the noise is excessive, check for low power steering pump fluid level before seeking service by your authorized dealer.
- Heavy or uneven steering efforts may be caused by low power steering pump fluid level. Check for low power steering pump fluid level before seeking service by your authorized dealer.
- Do not fill the power steering pump reservoir above the MAX mark on the reservoir, as this may result in leaks from the reservoir.

## Driving

If the power steering system breaks down (or if the engine is turned off), you can steer the vehicle manually, but it takes more effort.

If the steering wanders or pulls, check for:

- Underinflated tire(s) on any wheel(s)
- Uneven vehicle loading
- High crown in center of road
- High crosswinds
- Wheels out of alignment
- Loose or worn suspension components

### AIR SUSPENSION SYSTEM (IF EQUIPPED)

The air suspension system is designed to improve ride, handling and general vehicle performance during:

- Certain road conditions
- Steering maneuvers
- Braking
- Acceleration

This system keeps the rear of your vehicle at a constant level by automatically adding air or releasing air from the springs. If you exceed the load limit, the rear air suspension may not operate. The air suspension system will stay active for 40 minutes after the ignition is turned off to accommodate any load changes. (The air compressor may run when the vehicle is off; this is normal.)

The air suspension system can be enabled or disabled through the message center. Refer to *Message center* in the *Instrument Cluster* chapter.

If the system is off, the rear air suspension will not operate and will not raise (pump) or lower (vent) while the vehicle is not moving. However, if the system determines that the vehicle is low or high and needs to make a height adjustment while driving at speeds above 15 mph (24 km/h), the system will pump or vent as required. Normal vehicle operation does not require any action by the driver.



**WARNING:** On vehicles equipped with air suspension, turn the air suspension and the ignition switch off prior to jacking, hoisting or towing your vehicle.

## Driving

### LIMITED-SLIP AXLE (IF EQUIPPED)

This axle provides added traction on slippery surfaces, particularly when one wheel is on a poor traction surface. Under normal conditions, the limited slip axle functions like a standard rear axle.

Extended use of other than the manufacturer's specified size tires on a limited slip rear axle could result in a permanent reduction in effectiveness. This loss of effectiveness does not affect normal driving and should not be noticeable to the driver.

### PREPARING TO DRIVE



**WARNING:** Utility vehicles have a significantly higher rollover rate than other types of vehicles.



**WARNING:** In a rollover crash, an unbelted person is significantly more likely to die than a person wearing a seat belt.

Utility vehicles and trucks have larger tires and increased ground clearance, giving the vehicle a higher center of gravity than a passenger car.



**WARNING:** Vehicles with a higher center of gravity such as utility vehicles and trucks handle differently than vehicles with a lower center of gravity. Utility vehicles and trucks are **not** designed for cornering at speeds as high as passenger cars any more than low-slung sports cars are designed to perform satisfactorily under off-road conditions. Avoid sharp turns, excessive speed or abrupt maneuvers in these vehicles. Failure to drive cautiously could result in an increased risk of loss of vehicle control, vehicle rollover, personal injury and death.



**WARNING:** Loaded vehicles, with a higher center of gravity, may handle differently than unloaded vehicles. Do not overload your vehicle and use extra precautions, such as driving at slower speeds, avoiding abrupt steering changes and allowing for increased stopping distance, when driving a heavily loaded vehicle. Over-loading or loading the vehicle improperly can deteriorate handling capability and contribute to loss of vehicle control and vehicle rollover.

## Driving

### BRAKE-SHIFT INTERLOCK – COLUMN-SHIFT TRANSMISSION

This vehicle is equipped with a park/brake-shift interlock feature that prevents the gearshift lever from being moved from P (Park) when the ignition is in the on position unless brake pedal is pressed.

If you cannot move the gearshift lever out of P (Park) with ignition in the on position and the brake pedal pressed, or when the ignition is in the off position, it is possible that a fuse has blown or the vehicle's brake lamps are not operating properly. Refer to *Fuses and relays* in the *Roadside Emergencies* chapter.

If the fuse is not blown, perform the following procedure:

1. Apply the parking brake.
2. Turn the key to the off position.
3. Remove the access plug on top of the steering column.

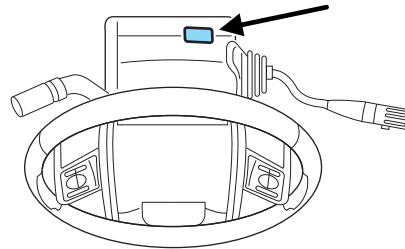

4. Using a flat-head screwdriver or similar tool, move the brake-shift interlock actuator spindle toward the left, apply the brake, place the key in the on position and shift the transmission into N (Neutral).
5. Start the vehicle.
6. Reinstall the access plug.

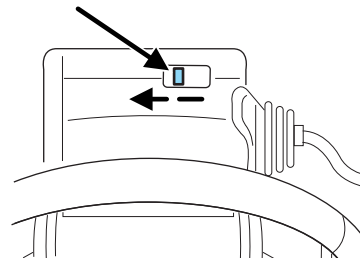

**WARNING:** Do not drive your vehicle until you verify that the brakelamps are working.



**WARNING:** Always set the parking brake fully and make sure the gearshift is latched in P (Park). Turn the ignition to the off position and remove the key whenever you leave your vehicle.

## Driving

 **WARNING:** If the parking brake is fully released, but the brake warning lamp remains illuminated, the brakes may not be working properly. See your authorized dealer.

### Brake-shift interlock – floor-shift transmission

This vehicle is equipped with a brake-shift interlock feature that prevents the gearshift lever from being moved from P (Park) when the ignition is in the on position unless the brake pedal is pressed.

If you cannot move the gearshift lever out of P (Park) with ignition in the on position and the brake pedal pressed, it is possible that a fuse has blown or the vehicle's brake lamps are not operating properly. Refer to *Fuses and relays* in the *Roadside Emergencies* chapter.

If the fuse is not blown and the brake lamps are working properly, the following procedure will allow you to move the gearshift lever from P (Park):

1. Apply the parking brake, turn the ignition key to the off position, and remove the key.

2. Using a screwdriver (or similar tool), carefully pry off and remove the chrome trim ring (1) from the shifter bezel base.

3. Remove the console tray insert and screw (2) from the trim panel.

4. Using a screwdriver (or similar tool), carefully pry the trim panel (3) up and disconnect it from the console to expose the inside of the gearshift.

5. Locate the brake shift interlock lever on the passenger side of the shifter assembly.

6. Apply the brake pedal and turn the ignition key to the on position. Using a screwdriver (or similar tool), press and hold the brake shift interlock lever while pulling the gearshift lever out of the P (Park) position and into the N (Neutral) position.

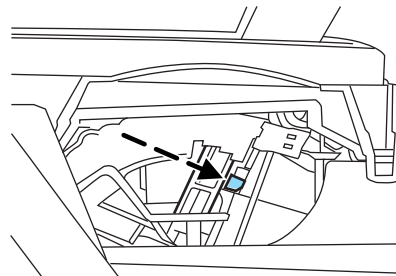
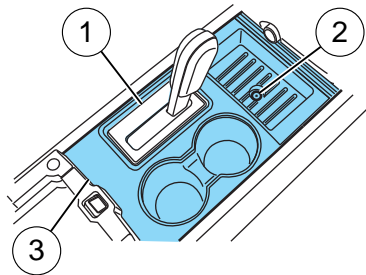

## Driving

7. Install the trim panel (3), screw (2) and chrome trim ring (1) in reverse order.
8. Apply brake pedal, start the vehicle, and release the parking brake.

**See your authorized dealer as soon as possible if this procedure is used.**



**WARNING:** Do not drive your vehicle until you verify that the brake lamps are working.



**WARNING:** Always set the parking brake fully and make sure the gearshift is latched in P (Park). Turn the ignition to the off position and remove the key whenever you leave your vehicle.



**WARNING:** If the parking brake is fully released, but the brake warning lamp remains illuminated, the brakes may not be working properly. See your authorized dealer.

## AUTOMATIC TRANSMISSION OPERATION

### Driving with a 6–speed automatic transmission

Your vehicle has been designed to improve fuel economy by reducing fuel usage while coasting or decelerating. When you take your foot off the accelerator pedal and the vehicle begins to slow down, the torque converter clutch locks up and aggressively shuts off fuel flow to the engine while decelerating. This fuel economy benefit may be perceived as a light to medium braking sensation when removing your foot from the accelerator pedal.

This vehicle is equipped with an Adaptive Transmission Shift Strategy. The Adaptive Transmission Shift Strategy offers the optimal transmission operation and shift quality. When the engine is turned off, the shift data which includes the adaptive information will be stored automatically in the Powertrain Control Module (PCM) and Transmission Control Module (TCM). If the battery is disconnected for any reason, the stored information from the last time the key was turned to OFF will be read. This way, no information will be lost with any battery removal or battery disconnect.



### **P (Park)**

This position locks the transmission and prevents the rear wheels from turning.

To put your vehicle in gear:

- Press the brake pedal
- Start the engine
- Move the gearshift lever into the desired gear. If your vehicle is equipped with a floor-shift transmission, press the gearshift lever release button (on the front of the lever) while shifting into the desired gear.

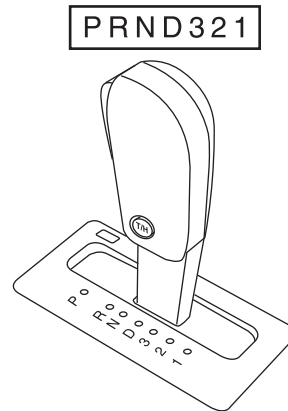

To put your vehicle in P (Park):

- Come to a complete stop
- Move the gearshift lever and securely latch it in P (Park)



**WARNING:** Always set the parking brake fully and make sure the gearshift is latched in P (Park). Turn the ignition to the off position and remove the key whenever you leave your vehicle.

### **R (Reverse)**

With the gearshift lever in R (Reverse), the vehicle will move backward. Always come to a complete stop before shifting into and out of R (Reverse).

### **N (Neutral)**

With the gearshift lever in N (Neutral), the vehicle can be started and is free to roll. Hold the brake pedal down while in this position.

### **D (Overdrive) with Tow/Haul Off**

The normal driving position for the best fuel economy. Transmission operates in gears one through six.

### **D (Overdrive) with Tow/Haul On**

The Tow/Haul feature improves transmission operation when towing a trailer or a heavy load. All transmission gear ranges are available when using Tow/Haul.

## Driving

Tow/Haul can be activated by pressing the transmission control switch on the end of the gearshift lever (column-shift transmission) or on the side of the gearshift lever (floor-shift transmission).

- Column-shift transmission

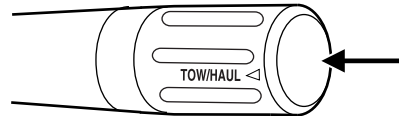

- Floor-shift transmission

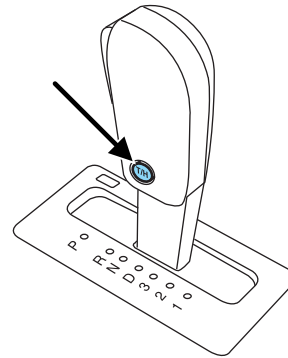

The TOW HAUL indicator light will illuminate in the instrument cluster.

**TOW  
HAUL**

Tow/Haul delays upshifts to reduce frequency of transmission shifting. Tow/Haul also provides engine braking in all forward gears when the transmission is in the D (Overdrive) position; this engine braking will slow the vehicle and assist the driver in controlling the vehicle when descending a grade. Depending on driving conditions and load conditions, the transmission may downshift, slow the vehicle and control the vehicle speed when descending a hill, without the accelerator pedal being pressed. The amount of downshift braking provided will vary based upon the amount the brake pedal is depressed.

To deactivate the Tow/Haul feature and return to normal driving mode, press the button on the end of the gearshift lever. The TOW HAUL light will no longer be illuminated.

## Driving

When you shut-off and restart the engine, the transmission will automatically return to normal D (Overdrive) mode (Tow/Haul OFF).



**WARNING:** Do not use the Tow/Haul feature when driving in icy or slippery conditions as the increased engine braking can cause the rear wheels to slide and the vehicle to swing around with the possible loss of vehicle control.

### 3 (Third)

Transmission operates in third gear only.

Used for improved traction on slippery roads. Selecting 3 (Third) provides engine braking.

### 2 (Second)

Transmission operates in 2nd gear only.

Use 2 (Second) to start-up on slippery roads or to provide additional engine braking on downgrades.

### 1 (First)

- Transmission operates in 1st gear only.
- Provides maximum engine braking.
- Allows upshifts by moving gearshift lever.
- Will not downshift into 1 (First) at high speeds; allows for 1 (First) when vehicle reaches slower speeds.

### Forced downshifts

- Allowed in D (Drive) only.
- Press the accelerator to the floor.
- Allows transmission to select an appropriate gear.

### If your vehicle gets stuck in mud or snow

If your vehicle gets stuck in mud or snow, it may be rocked out by shifting between forward and reverse gears, stopping between shifts in a steady pattern. Press lightly on the accelerator in each gear.

**Do not rock the vehicle if the engine is not at normal operating temperature or damage to the transmission may occur.**

**Do not rock the vehicle for more than a minute or damage to the transmission and tires may occur, or the engine may overheat.**

If your vehicle is equipped with AdvanceTrac® with RSC®, it may be beneficial to turn the system off so the wheels are allowed to spin.

## Driving

### REVERSE SENSING SYSTEM (IF EQUIPPED)

The reverse sensing system (RSS) sounds a tone to warn the driver of obstacles near the rear bumper when R (Reverse) is selected and the vehicle is moving at speeds less than 3 mph (5 km/h). The system is not effective at speeds above 3 mph (5 km/h) and may not detect certain angular or moving objects.

 **WARNING:** To help avoid personal injury, please read and understand the limitations of the reverse sensing system as contained in this section. Reverse sensing is only an aid for some (generally large and fixed) objects when moving in reverse on a flat surface at “parking speeds”. Inclement weather may also affect the function of the RSS; this may include reduced performance or a false activation.

 **WARNING:** To help avoid personal injury, always use caution when in R (Reverse) and when using the RSS.

 **WARNING:** This system is not designed to prevent contact with small or moving objects. The system is designed to provide a warning to assist the driver in detecting large stationary objects to avoid damaging the vehicle. The system may not detect smaller objects, particularly those close to the ground.

 **WARNING:** Certain add-on devices such as large trailer hitches, bike or surfboard racks and any device that may block the normal detection zone of the RSS system may create false beeps.

## Driving

The RSS detects obstacles up to six feet (two meters) from the rear bumper with a decreased coverage area at the outer corners of the bumper, (refer to the figures for approximate zone coverage areas). As you move closer to the obstacle, the rate of the tone increases. When the obstacle is less than 10 inches (25.0 cm) away, the tone will sound continuously. If the RSS detects a stationary or receding object further than 10 inches (25.0 cm) from the side of the vehicle, the tone will sound for only three seconds. Once the system detects an object approaching, the tone will sound again.

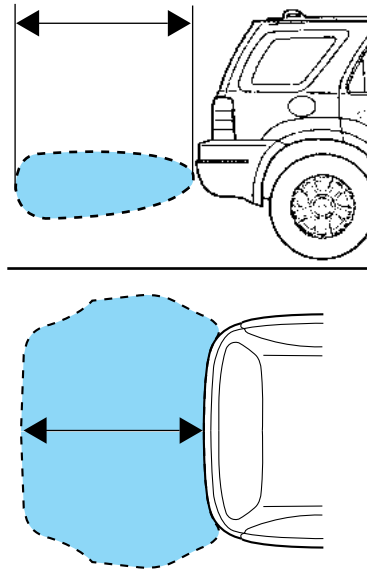

While receiving a warning, the radio volume will be reduced to a predetermined level. After the warning goes away, the radio will return to the previous value.

The RSS automatically turns on when the gearshift lever is placed in R (Reverse) and the ignition is on. An RSS control on the instrument panel allows the driver to turn the RSS on and off. To turn the RSS off, refer to *Message center* in the *Instrument cluster* chapter for more information.

**Keep the RSS sensors (located on the rear bumper/fascia) free from snow, ice and large accumulations of dirt (do not clean the sensors with sharp objects). If the sensors are covered, it will affect the accuracy of the RSS.**

**If your vehicle sustains damage to the rear bumper/fascia, leaving it misaligned or bent, the sensing zone may be altered causing inaccurate measurement of obstacles or false alarms.**

## Driving

### REARVIEW CAMERA SYSTEM (IF EQUIPPED)

The camera system located on the liftgate provides a video image, which appears in the rearview mirror or on the navigation screen (if equipped), of the area behind the vehicle. It adds assistance to the driver while reversing or reverse parking the vehicle.

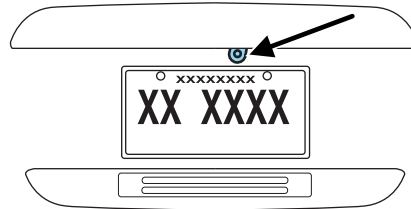

To use the camera system, place the transmission in R (Reverse); an image will display on the left portion of the rearview mirror or on the navigation screen (if equipped). The area displayed on the screen may vary according to the vehicle orientation and/or road condition.

- (1) Rear bumper
- (2) Red zone
- (3) Yellow zone
- (4) Green zone
- (5) Centerline of vehicle

Always use caution while backing.

Objects in the red zone are closest to your vehicle and objects in the green zone are further away. Objects are getting closer to your vehicle as they move from the green zone to the yellow or red zones.

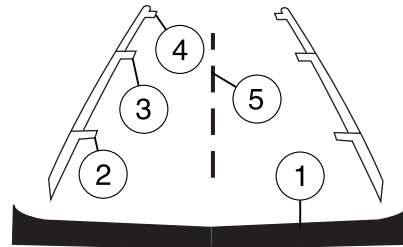

Use the side mirrors and rearview mirror to get better coverage on both sides and rear of the vehicle.

#### **Image delay if displayed through the rearview mirror:**

When shifting out of R (Reverse) and into any other gear, the image in the rearview mirror will remain on for a few seconds before it shuts off to assist in parking or trailer hookup.

#### **Image delay if displayed through the navigation screen:**

After shifting out of R (Reverse) and into any gear other than P (Park), the image in the navigation screen will remain until the vehicle speed reaches 5 mph (8 km/h), only if the rear camera delay feature is on, or until any navigation radio button is pressed.

## Driving

**Note:** The default setting for the camera delay is off. Press the “Settings” button found on the navigation screen (if equipped) to set the camera delay feature to on or off.

When towing, the camera system will only see what is being towed behind the vehicle; this might not provide adequate coverage as it usually provides in normal operation and some objects might not be seen.

The camera lens for the camera is located on the liftgate, above the license plate. Keep the lens clean so the video image remains clear and undistorted. Clean the lens with a soft, lint-free cloth and non-abrasive cleaner.

**Note:** If the camera system image is not clear or seems distorted, it may be covered with water droplets, snow, mud or any other substance. If this occurs, clean the camera lens before using the reverse camera system.



**WARNING:** The camera system is a reverse aid supplement device that still requires the driver to use it in conjunction with the rearview mirror and the side mirrors for maximum coverage.



**WARNING:** Objects that are close to either corner of the bumper or under the bumper, might not be seen on the screen due to the limited coverage of the camera system.



**WARNING:** Backup as slow as possible since higher speeds might limit your reaction time to stop the vehicle.



**WARNING:** Do not use the camera system with the liftgate open.

If the back end of the vehicle is hit or damaged, then check with your authorized dealer to have your rear video system checked for proper coverage and operation.

### **Night time and dark area use**

At night time or in dark areas, the reverse camera system relies on the reverse lamp lighting to produce an image. Therefore it is necessary that both reverse lamps are operating in order to get a clear image in the dark. If either of the lamps are not operating, stop using the camera system, at least in the dark, until the lamp(s) are replaced and functioning.

## Driving

### Servicing

- If the image comes on while the vehicle is not in R (Reverse), have the system inspected by your authorized dealer.
- If the image is not clear, then check if there is anything covering the lens such as dirt, mud, ice, snow, etc. If the image is still not clear after cleaning, have your system inspected by your authorized dealer.

### CONTROL TRAC FOUR-WHEEL DRIVE (4X4) OPERATION (IF EQUIPPED)



**WARNING:** For important information regarding safe operation of this type of vehicle, see *Preparing to drive your vehicle* in this chapter.

**If equipped with the Control Trac® 4X4 System, and 4L (4X4 LOW) is selected while the vehicle is moving faster than 3 mph (5 km/h), the system will not engage. This is normal and should be no reason for concern. Before 4L (4X4 LOW) can be engaged, the vehicle must be stopped or moving slower than 3 mph (5 km/h) and the transmission placed in N (Neutral).**

See the *Message center* in the *Instrument Cluster* section to complete the 4L shift if either shift condition is not met.

Do not use 4H (4X4) or 4L (4X4 LOW) on dry, hard surfaced roads. Doing so will produce excessive noise, increased tire wear and may damage drive components. 4H (4X4) and 4L (4X4 LOW) are only intended for consistently slippery or loose surfaces. Use of 4H (4X4) or 4L (4X4 LOW) on these surfaces may produce some noise (such as occasional clunks) but will not damage drive components.

Your 4x4 features the heavy-duty Control Trac system which includes a computer-operated transfer case. This unique system is interactive with the road, continually monitoring and adjusting torque delivery to the front and rear wheels to optimize vehicle control.



### 4WD indicator lights

The indicator lights illuminate in the message center in the reconfigurable telltale (RTT) location under the following conditions. Refer to *Warning lights and chimes* in the *Instrument Cluster* chapter.

- **4X2** - Momentarily illuminates when 2H is selected. **4x2**
- **4X4 AUTO** – Illuminates when 4X4 AUTO is selected. **4x4  
AUTO**
- **4X4** – Illuminates when 4X4 is selected. **4x4**
- **4X4 LOW** - Illuminates when 4L is selected. **4x4  
LOW**

### Positions of the Control Trac system

The Control Trac® system functions in four modes:

- **2H (4X2)** delivers power to the rear wheels only. The message center will momentarily display “4x2” when this mode is selected. This is appropriate for normal on-road driving on dry pavement and provides best fuel economy.
- **4A (4X4 AUTO)** provides electronic control four-wheel drive with power delivered to all four wheels, as required, for increased traction. The message center will display “4X4 AUTO” when this position is selected. This is appropriate for all on-road driving conditions, such as dry road surfaces, wet pavement, snow or gravel.
- **4H (4X4)** provides electronically locked four-wheel drive power to front and rear wheels. The message center will display “4X4” when this position is selected. This position is not recommended for use on dry pavement. This position is only intended for severe winter or off-road conditions, such as deep snow, ice or shallow sand.

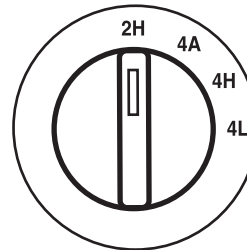

## Driving

- **4L (4X4 LOW)** provides electronically locked four-wheel drive when extra power at reduced speeds is required. The message center will display “4X4 LOW” when this position is selected. This position is not recommended for use on dry pavement. Use this position for off-road low-speed operation or when extra power is required, such as climbing steep grades, going through deep sand or pulling a boat out of the water.

**Note:** If your vehicle is equipped with AdvanceTrac® with RSC®, the AdvanceTrac® with RSC® system will automatically turn off the stability enhancement feature when you shift the Control Trac® four-wheel drive system into 4L (4X4 LOW). The brake traction enhancement feature will still be enabled.

The AdvanceTrac® with RSC® stability enhancement system can be turned off manually by pressing the AdvanceTrac® with RSC® button (refer to *AdvanceTrac® with Roll Stability Control™ (RSC®) Stability Enhancement System* in this chapter) while operating in 2H, 4A or 4H while driving in deep sand, very deep snow or more strenuous off-road maneuvers. This will disable the engine management feature, allowing the vehicle to maintain full power and enhanced momentum through the obstacle.



**WARNING:** Utility and four-wheel drive vehicles are **not** designed for cornering at speeds as high as passenger cars any more than low-slung sports cars are designed to perform satisfactorily under off-road conditions. Avoid sharp turns or abrupt maneuvers in these vehicles.

**Note:** The Control Trac® selector knob should not be changed while the rear wheels are slipping.

### Shifting between modes

#### **Shifting between 2H and 4A or 4H**

Move the control from 2H to the 4A or 4H position at any forward speed or at a stop. The message center may display **4X4 SHIFT IN PROGRESS** during the system shift. The message center will then display 4X4 AUTO if 4A is selected or 4X4 if 4H is selected. The message center will momentarily display 4X2 if 2H is selected.

#### **Shifting between 4A and 4H**

Move the control between 4A to 4H at a stop or while driving at any speed. The message center will display 4X4 if 4H is selected and 4X4 Auto if 4A is selected.

### **Shifting to/from 4L**

1. Bring the vehicle to a speed of 3 mph (5 km/h) or less.
2. Place the gearshift in N (Neutral).
3. Move the control to the desired position.

The message center will display **4X4 SHIFT IN PROGRESS** during the shift. The message center will then display the system mode selected.

If any of the above shift conditions are not met, the shift will not occur and the message center will display information guiding the driver through the proper range shifting procedures listed above.

If **SHIFT DELAYED PULL FORWARD** is displayed in the message center, transfer case gear tooth blockage is present. To alleviate this condition, place the transmission in a forward gear, move the vehicle forward approximately 5 feet (2 meters), and shift the transmission back to neutral to allow the transfer case to complete the range shift.

**Note:** Some noise may be heard as the system shifts or engages.

### **Driving off-road with truck and utility vehicles**

Four-wheel drive vehicles are specially equipped for driving on sand, snow, mud and rough terrain and have operating characteristics that are somewhat different from conventional vehicles, both on and off the road.

The AdvanceTrac® with Roll Stability Control™ (RSC®) stability enhancement system can be turned off manually by pressing the AdvanceTrac® with RSC® button (refer to *AdvanceTrac® with Roll Stability Control™ (RSC®) Stability Enhancement System* in this chapter) while operating in 2H, 4A or 4H while driving in deep sand, very deep snow or more strenuous off-road maneuvers. This will disable the engine management feature, allowing the vehicle to maintain full power and enhanced momentum through the obstacle.

### **How your vehicle differs from other vehicles**

Truck and utility vehicles can differ from some other vehicles. Your vehicle may be higher to allow it to travel over rough terrain without getting hung up or damaging underbody components.

The differences that make your vehicle so versatile also make it handle differently than an ordinary passenger car.

Maintain steering wheel control at all times, especially in rough terrain. Since sudden changes in terrain can result in abrupt steering wheel motion, make sure you grip the steering wheel from the outside. Do not grip the spokes.

## Driving

Drive cautiously to avoid vehicle damage from concealed objects such as rocks and stumps.

You should either know the terrain or examine maps of the area before driving. Map out your route before driving in the area. To maintain steering and braking control of your vehicle, you must have all four wheels on the ground and they must be rolling, not sliding or spinning.

### **Basic operating principles**

- Do not use 4H (4X4) or 4L (4X4 LOW) on dry, hard surfaced roads. Doing so will produce excessive noise, increased tire wear and may damage drive components. 4H (4X4) and 4L (4X4 LOW) are only intended for consistently slippery or loose surfaces. Use of 4H (4X4) or 4L (4X4 LOW) on these surfaces may produce some noise, such as occasional clunks, but will not damage drive components.
- Drive slower in strong crosswinds which can affect the normal steering characteristics of your vehicle.
- Be extremely careful when driving on pavement made slippery by loose sand, water, gravel, snow or ice.

### **If your vehicle goes off the edge of the pavement**

- If your vehicle goes off the edge of the pavement, slow down, but avoid severe brake application. Ease the vehicle back onto the pavement only after reducing your speed. Do not turn the steering wheel too sharply while returning to the road surface.
- It may be safer to stay on the apron or shoulder of the road and slow down gradually before returning to the pavement. You may lose control if you do not slow down or if you turn the steering wheel too sharply or abruptly.
- It often may be less risky to strike small objects, such as highway reflectors, with minor damage to your vehicle rather than attempt a sudden return to the pavement which could cause the vehicle to slide sideways out of control or roll over. Remember, your safety and the safety of others should be your primary concern.



**WARNING:** Vehicles with a higher center of gravity such as utility and four-wheel drive vehicles handle differently than vehicles with a lower center of gravity. Utility and four-wheel drive vehicles are **not** designed for cornering at speeds as high as passenger cars any more than low-slung sports cars are designed to perform satisfactorily under off-road conditions. Avoid sharp turns, excessive speed and abrupt maneuvers in these vehicles. Failure to drive cautiously could result in an increased risk of loss of vehicle control, vehicle rollover, personal injury and death.

## Driving

### ***If your vehicle gets stuck***

If your vehicle gets stuck in mud or snow it may be rocked out by shifting between forward and reverse gears, stopping between shifts, in a steady pattern. Press lightly on the accelerator in each gear.

**Do not rock the vehicle if the engine is not at normal operating temperature or damage to the transmission may occur.**

**Do not rock the vehicle for more than a few minutes or damage to the transmission and tires may occur or the engine may overheat.**



**WARNING:** Always set the parking brake fully and make sure the gearshift is latched in P (Park). Turn the ignition to the LOCK position and remove the key whenever you leave your vehicle.



**WARNING:** If the parking brake is fully released, but the brake warning lamp remains illuminated, the brakes may not be working properly. See your authorized dealer.



**WARNING:** Do not spin the wheels at over 35 mph (56 km/h). The tires may fail and injure a passenger or bystander.

### ***Emergency maneuvers***

- In an unavoidable emergency situation where a sudden sharp turn must be made, remember to avoid “over-driving” your vehicle, i.e., turn the steering wheel only as rapidly and as far as required to avoid the emergency. Excessive steering will result in less vehicle control, not more. Additionally, smooth variations of the accelerator and/or brake pedal pressure should be utilized if changes in vehicle speed are called for. Avoid abrupt steering, acceleration or braking which could result in an increased risk of loss of vehicle control, vehicle rollover and/or personal injury. Use all available road surface to return the vehicle to a safe direction of travel.
- In the event of an emergency stop, avoid skidding the tires and do not attempt any sharp steering wheel movements.

## Driving



**WARNING:** Vehicles with a higher center of gravity such as utility and four-wheel drive vehicles handle differently than vehicles with a lower center of gravity. Utility and four-wheel drive vehicles are **not** designed for cornering at speeds as high as passenger cars any more than low-slung sports cars are designed to perform satisfactorily under off-road conditions. Avoid sharp turns, excessive speed and abrupt maneuvers in these vehicles. Failure to drive cautiously could result in an increased risk of loss of vehicle control, vehicle rollover, personal injury and death.

- If the vehicle goes from one type of surface to another (i.e., from concrete to gravel) there will be a change in the way the vehicle responds to a maneuver (steering, acceleration or braking). Again, avoid these abrupt inputs.

### **Control Trac four-wheel drive system (if equipped)**

When a four-wheel drive mode is selected, the Control Trac system uses all four wheels to power the vehicle. This increases traction, enabling you to drive over terrain and road conditions that a conventional two-wheel drive vehicle cannot.

Power is supplied to all four wheels through a transfer case. On four-wheel drive vehicles, the transfer case allows you to select four-wheel drive when necessary. Information on transfer case operation and shifting procedures can be found in this chapter. Information on transfer case maintenance can be found in the *Maintenance and Specifications* chapter. You should become thoroughly familiar with this information before you operate your vehicle.

### **Normal characteristics**

On some four-wheel drive models, the initial shift from two-wheel drive to four-wheel drive while the vehicle is moving can cause some momentary clunk and ratcheting sounds. This is the front drivetrain coming up to speed and engaging the front wheels, and is not cause for concern.

### **Sand**

When driving over sand, try to keep all four wheels on the most solid area of the trail. Avoid reducing the tire pressures but shift to a lower gear and drive steadily through the terrain. Apply the accelerator slowly and avoid spinning the wheels.

**Note:** If air is released from your tires, the Tire Pressure Monitoring System (TPMS) indicator light may illuminate.

## Driving

Avoid excessive speed because vehicle momentum can work against you and cause the vehicle to become stuck to the point that assistance may be required from another vehicle. Remember, you may be able to back out the way you came if you proceed with caution.

If your vehicle is equipped with AdvanceTrac® with RSC, press the AdvanceTrac® with RSC button (refer to *AdvanceTrac® with Roll Stability Control (RSC) Stability Enhancement System* in this chapter) while driving in deep sand if you experience excessive engine power reduction.

### **Mud and water**

If you must drive through high water, drive slowly. Traction or brake capability may be limited.

When driving through water, determine the depth; avoid water higher than the bottom of the hubs (if possible) and proceed slowly. If the ignition system gets wet, the vehicle may stall.

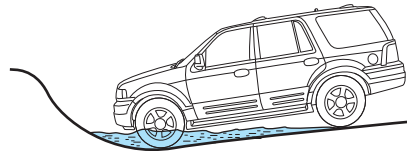

Once through water, always try the brakes. Wet brakes do not stop the vehicle as effectively as dry brakes. Drying can be improved by moving your vehicle slowly while applying light pressure on the brake pedal.

Be cautious of sudden changes in vehicle speed or direction when you are driving in mud. Even four-wheel drive vehicles can lose traction in slick mud. As when you are driving over sand, apply the accelerator slowly and avoid spinning your wheels. If the vehicle does slide, steer in the direction of the slide until you regain control of the vehicle.

If the transmission, transfer case, front axle or rear axle are submerged in water, their fluids should be checked and changed, if necessary.

### **Driving through deep water may damage the transmission.**

If the front or rear axle is submerged in water, the axle lubricant should be replaced.

After driving through mud, clean off residue stuck to rotating driveshafts and tires. Excess mud stuck on tires and rotating driveshafts causes an imbalance that could damage drive components.

## Driving

“Tread Lightly” is an educational program designed to increase public awareness of land-use regulations and responsibilities in our nation's wilderness areas. Ford Motor

Company joins the U.S. Forest Service and the Bureau of Land Management in encouraging you to help preserve our national forest and other public and private lands by “treading lightly.”



### ***Driving on hilly or sloping terrain***

Although natural obstacles may make it necessary to travel diagonally up or down a hill or steep incline, you should always try to drive straight up or straight down. **Avoid driving crosswise or turning on steep slopes or hills.** A danger lies in losing traction, slipping sideways and possibly rolling over. Whenever driving on a hill, determine beforehand the route you will use. Do not drive over the crest of a hill without seeing what conditions are on the other side. Do not drive in reverse over a hill without the aid of an observer.

When climbing a steep slope or hill, start in a lower gear rather than downshifting to a lower gear from a higher gear once the ascent has started. This reduces strain on the engine and the possibility of stalling.

If you do stall out, do not try to turn around because you might roll over. It is better to back down to a safe location.

Apply just enough power to the wheels to climb the hill. Too much power will cause the tires to slip, spin or lose traction, resulting in loss of vehicle control.

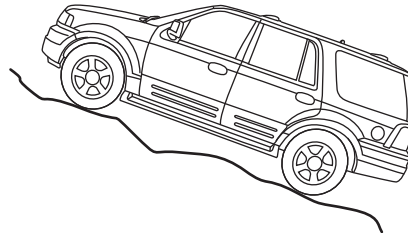



## Driving

Descend a hill in the same gear you would use to climb up the hill to avoid excessive brake application and brake overheating. Do not descend in neutral; instead, disengage overdrive or manually shift to a lower gear. When descending a steep hill, avoid sudden hard braking as you could lose control. When you brake hard, the front wheels can't turn and if they aren't turning, you won't be able to steer. The front wheels have to be turning in order to steer the vehicle. Rapid pumping of the brake pedal will help you slow the vehicle and still maintain steering control.

If your vehicle has anti-lock brakes, apply the brakes steadily. Do not "pump" the brakes.

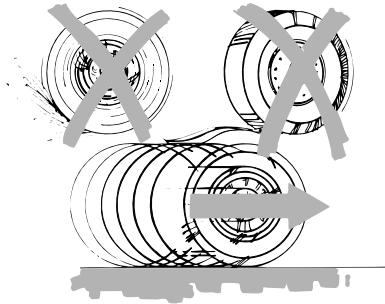

### **Driving on snow and ice**

Four-wheel drive vehicles have advantages over two-wheel drive vehicles in snow and ice but can skid like any other vehicle.

Should you start to slide while driving on snowy or icy roads, turn the steering wheel in the direction of the slide until you regain control.

Avoid sudden applications of power and quick changes of direction on snow and ice. Apply the accelerator slowly and steadily when starting from a full stop.

Avoid sudden braking as well. Although a four-wheel drive vehicle may accelerate better than a two-wheel drive vehicle in snow and ice, it won't stop any faster, because as in other vehicles, braking occurs at all four wheels. Do not become overconfident as to road conditions.

Make sure you allow sufficient distance between you and other vehicles for stopping. Drive slower than usual and consider using one of the lower gears. In emergency stopping situations, apply the brake forcefully and steadily. Do not "pump" the brakes. Refer to the *Brakes* section of this chapter for additional information on the operation of the anti-lock brake system.



**WARNING:** If you are driving in slippery conditions that require tire chains or cables, then it is critical that you drive cautiously. Keep speeds down, allow for longer stopping distances and avoid aggressive steering to reduce the chances of a loss of vehicle control which can lead to serious injury or death. If the rear end of the vehicle slides while cornering, steer in the direction of the slide until you regain control of the vehicle.

## Driving

### **Maintenance and modifications**

The suspension and steering systems on your vehicle have been designed and tested to provide predictable performance whether loaded or empty and durable load carrying capability. For this reason, Ford Motor Company strongly recommends that you do not make modifications such as adding or removing parts (such as lift kits or stabilizer bars) or by using replacement parts not equivalent to the original factory equipment.

Any modifications to a vehicle that raise the center of gravity can make it more likely the vehicle will roll over as a result of a loss of control. Ford Motor Company recommends that caution be used with any vehicle equipped with a high load or device (such as ladder racks or pickup box cover).

Failure to maintain your vehicle properly may void the warranty, increase your repair cost, reduce vehicle performance and operational capabilities and adversely affect driver and passenger safety. Frequent inspection of vehicle chassis components is recommended if the vehicle is subjected to heavy off-road usage.

### **DRIVING THROUGH WATER**

If driving through deep or standing water is unavoidable, proceed very slowly especially when the depth is not known. Never drive through water that is higher than the bottom of the wheel rims (for cars) or the bottom of the hubs (for trucks).

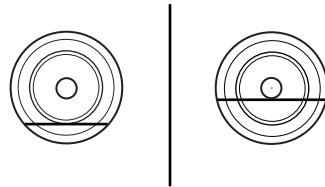

When driving through water, traction or brake capability may be limited. Also, water may enter your engine's air intake and severely damage your engine or your vehicle may stall. **Driving through deep water where the transmission vent tube is submerged may allow water into the transmission and cause internal transmission damage.**

**Once through the water, always dry the brakes by moving your vehicle slowly while applying light pressure on the brake pedal.** Wet brakes do not stop the vehicle as quickly as dry brakes.

## Roadside Emergencies

### ROADSIDE ASSISTANCE

#### Getting roadside assistance

To fully assist you should you have a vehicle concern, Ford Motor Company offers a complimentary roadside assistance program. This program is separate from the New Vehicle Limited Warranty. The service is available:

- 24-hours, seven days a week
- for the coverage period listed on the Roadside Assistance Card included in your Owner Guide portfolio.

Roadside assistance will cover:

- a flat tire change with a good spare (except vehicles that have been supplied with a tire inflation kit)
- battery jump start
- lock-out assistance (key replacement cost is the customer's responsibility)
- fuel delivery – Independent Service Contractors, if not prohibited by state, local or municipal law shall deliver up to 2.0 gallons (7.5L) of gasoline or 5.0 gallons (18.9L) of diesel fuel to a disabled vehicle. Fuel delivery service is limited to two no-charge occurrences within a 12-month period.
- winch out – available within 100 feet (30.5 meters) of a paved or county maintained road, no recoveries.
- towing – Ford/Mercury/Lincoln eligible vehicle towed to an authorized dealer within 35 miles (56 km) of the disablement location or to the nearest authorized dealer. If a member requests to be towed to an authorized dealer more than 35 miles (56 km) from the disablement location, the member shall be responsible for any mileage costs in excess of 35 miles (56 km).

Trailers shall be covered up to \$200 if the disabled eligible vehicle requires service at the nearest authorized dealer. If the trailer is disabled, but the towing vehicle is operational, the trailer does not qualify for any roadside services.

**Canadian customers refer to your Warranty Guide or visit our website at [www.ford.ca](http://www.ford.ca) for information on:**

## Roadside Emergencies

### Using roadside assistance

Complete the roadside assistance identification card and place it in your wallet for quick reference. In the United States, this card is found in the Owner Guide portfolio in the glove compartment. In Canada, the card is found in the *Warranty Guide* in the glove compartment.

U.S. Ford, Mercury and Lincoln vehicle customers who require Roadside Assistance, call 1-800-241-3673.

Canadian customers who require roadside assistance, call 1-800-665-2006.

If you need to arrange roadside assistance for yourself, Ford Motor Company will reimburse a reasonable amount for towing to the nearest dealership within 35 miles (56 km). To obtain reimbursement information, U.S. Ford, Mercury and Lincoln vehicle customers call 1-800-241-3673. Customers will be asked to submit their original receipts.

Canadian customers who need to obtain reimbursement information, call 1-800-665-2006 or visit our website at [www.ford.ca](http://www.ford.ca).

### HAZARD FLASHER CONTROL

The hazard flasher control is located on the instrument panel by the radio. The hazard flashers will operate when the ignition is in any position or if the key is not in the ignition.



Press the flasher control and all front and rear direction signals will flash. Press the flasher control again to turn them off. Use it when your vehicle is disabled and is creating a safety hazard for other motorists.

**Note:** With extended use, the flasher may run down your battery.

## Roadside Emergencies

### FUEL PUMP SHUT-OFF SWITCH FUEL RESET

The fuel pump shut-off switch is a device intended to stop the electric fuel pump when your vehicle has been involved in a substantial jolt.

After a collision, if the engine cranks but does not start, the fuel pump shut-off switch may have been activated.

The fuel pump shut-off switch is located behind an access panel in the left rear quarter trim panel, near the liftgate.

The fuel pump shut-off switch has a red reset button on top of it.

If your vehicle is equipped with a power liftgate, the fuel pump shut-off switch will be left of the power liftgate motor.

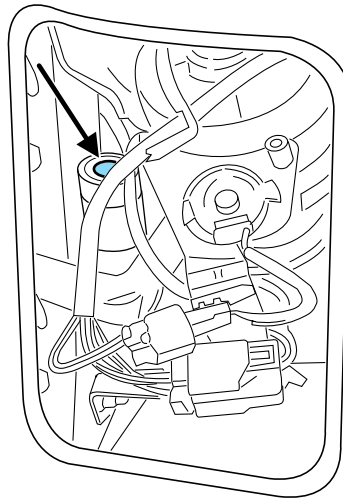

Use the following procedure to reset the fuel pump shut-off switch.

1. Turn the ignition to the off position.
2. Check the fuel system for leaks.
3. If no fuel leak is apparent, reset the fuel pump shut-off switch by pushing in on the reset button.
4. Turn the ignition to the on position. Pause for a few seconds and return the key to the off position.
5. Make a further check for leaks in the fuel system.

## Roadside Emergencies

### FUSES AND RELAYS

#### Fuses

If electrical components in the vehicle are not working, a fuse may have blown. Blown fuses are identified by a broken wire within the fuse. Check the appropriate fuses before replacing any electrical components.

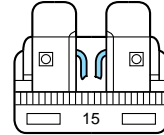

**Note:** Always replace a fuse with one that has the specified amperage rating. Using a fuse with a higher amperage rating can cause severe wire damage and could start a fire.

#### Standard fuse amperage rating and color

COLOR					
Fuse rating	Mini fuses	Standard fuses	Maxi fuses	Cartridge maxi fuses	Fuse link cartridge
2A	Grey	Grey	—	—	—
3A	Violet	Violet	—	—	—
4A	Pink	Pink	—	—	—
5A	Tan	Tan	—	—	—
7.5A	Brown	Brown	—	—	—
10A	Red	Red	—	—	—
15A	Blue	Blue	—	—	—
20A	Yellow	Yellow	Yellow	Blue	Blue
25A	Natural	Natural	—	Natural	Natural
30A	Green	Green	Green	Pink	Pink
40A	—	—	Orange	Green	Green
50A	—	—	Red	Red	Red
60A	—	—	Blue	Yellow	Yellow
70A	—	—	Tan	—	Brown
80A	—	—	Natural	Black	Black

## Roadside Emergencies

### Passenger compartment fuse panel

The fuse panel is located under the right-hand side of the instrument panel.

To remove the trim panel for access to the fuse box, pull the panel toward you and swing it out away from the side and remove it. To reinstall it, line up the tabs with the grooves on the panel, then push it shut.

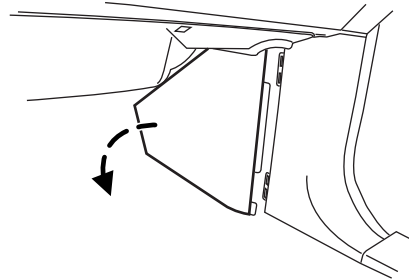

To remove the fuse box cover, press in the tabs on both sides of the cover, then pull the cover off.

To reinstall the fuse box cover, place the top part of the cover on the fuse panel, then push the bottom part of the cover until you hear it click shut. Gently pull on the cover to make sure it is seated properly.

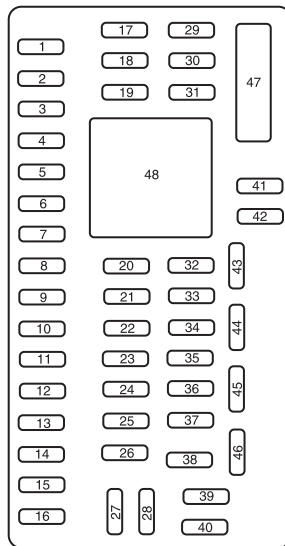

## Roadside Emergencies

The fuses are coded as follows:

Fuse/Relay Location	Fuse Amp Rating	Protected Circuits
1	30A	Driver window
2	15A	Driver side memory module
3	15A	Audio rear seat controls, Satellite radio, SYNC®
4	30A	Not used (spare)
5	10A	Keypad illumination, 3rd row seat enable, Brake shift interlock (BSI), Smart fuse panel logic power
6	20A	Turn signals
7	10A	Low beam headlamps (left)
8	10A	Low beam headlamps (right)
9	15A	Interior lights
10	15A	Switch backlighting, Puddle lamps
11	10A	Not used (spare)
12	7.5A	Power mirrors, Driver seat memory switch
13	5A	Not used (spare)
14	10A	Power liftgate module – keep-alive power
15	10A	Climate control, Global positioning satellite module
16	15A	Not used (spare)
17	20A	Door locks, Liftgate release, Liftglass release
18	20A	Second row heated seats
19	25A	Rear wiper
20	15A	Adjustable pedals, Datalink
21	15A	Fog lamps
22	15A	Park lamps
23	15A	High beam headlamps



## Roadside Emergencies

Fuse/Relay Location	Fuse Amp Rating	Protected Circuits
24	20A	Horn
25	10A	Demand lamps, Glovebox, Visor
26	10A	Instrument panel cluster
27	20A	Ignition switch
28	5A	Radio
29	5A	Instrument panel cluster
30	5A	Not used (spare)
31	10A	Not used (spare)
32	10A	Airbag module
33	10A	Not used (spare)
34	5A	Not used (spare)
35	10A	Rear park assist, 4x4, rear video camera, 2nd row heated seats
36	5A	Passive anti-theft system
37	10A	Climate control
38	20A	Subwoofer
39	20A	Radio
40	20A	Navigation amplifier
41	15A	Power windows, Power vents, Power moon roof, Auto dimming rear view mirror, 110V AC power point
42	10A	Not used (spare)
43	10A	Rear wiper logic, Rain sensor
44	10A	Trailer tow battery charge relay coil
45	5A	Front wiper logic
46	7.5A	Climate control, Auxiliary relay control
47	30A Circuit Breaker	Power windows, Moon roof
48	—	Delayed accessory relay

## Roadside Emergencies

### Power distribution box

The power distribution box is located in the engine compartment. The power distribution box contains high-current fuses that protect your vehicle's main electrical systems from overloads.



**WARNING:** Always disconnect the battery before servicing high current fuses.



**WARNING:** To reduce risk of electrical shock, always replace the cover to the power distribution box before reconnecting the battery or refilling fluid reservoirs.

If the battery has been disconnected and reconnected, refer to the *Battery* section of the *Maintenance and Specifications* chapter.

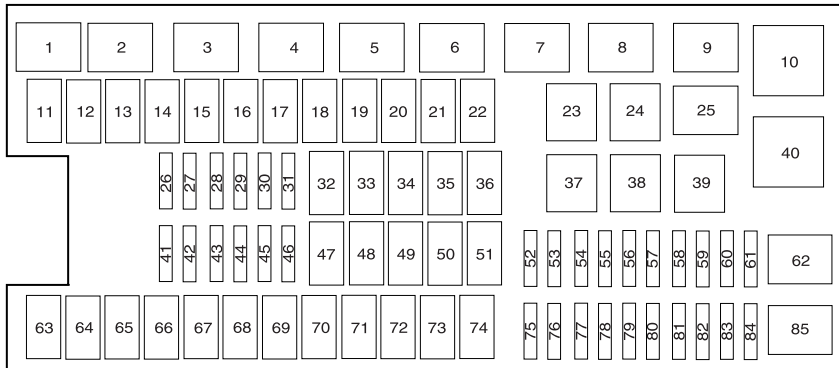

The high-current fuses are coded as follows:

Fuse/Relay Location	Fuse Amp Rating	Protected Circuits
1	—	Powertrain control module (PCM) relay
2	—	Starter relay
3	—	Blower motor relay

## Roadside Emergencies

Fuse/Relay Location	Fuse Amp Rating	Protected Circuits
4	—	Trailer tow (TT) battery charge relay
5	—	Fuel pump relay
6	—	Electronic fan 1 relay
7	—	Rear window defroster/heated mirror relay
8	—	Electronic fan 3 relay
9	—	Run/Start (R/S) relay
10	—	Rear air suspension (RAS) relay
11	40A**	Power running board
12	40A**	R/S relay
13	30A **	Starter relay
14	40A**	Electronic fan
15	—	Not used
16	40A**	Electronic fan
17	—	Not used
18	30A**	Trailer brake
19	60A**	RAS relay feed
20	20A**	4x4 module
21	30A**	TT battery charge relay
22	30A**	Passenger power seat
23	—	A/C clutch relay
24	—	TT park lamp relay
25	—	Not used
26	15A*	Transmission control module (TCM) keep-alive power
27	20A*	4x4
28	25A*	Trailer tow park lamp relay
29	20A*	Backup lamps, Integrated wheel end solenoid
30	10A*	A/C clutch relay
31	—	Not used

## Roadside Emergencies

Fuse/Relay Location	Fuse Amp Rating	Protected Circuits
32	40A**	Blower motor relay
33	40A**	110V AC power point
34	30A**	Auxiliary blower motor
35	30A**	PCM relay
36	30A**	Power liftgate
37	—	TT left hand stop/turn relay
38	—	TT right hand stop/turn relay
39	—	Backup lamps relay
40	—	Electronic fan 2 relay
41	10A*	PCM keep-alive power
42	—	Not used
43	5A*	Brake on/off switch
44	20A*	Fuel pump relay
45	25A*	TT stop/turn lamps relay
46	—	Not used
47	—	Not used
48	30A**	RAS module
49	—	Not used
50	30A**	Front wiper motor relay
51	40A**	Rear window defroster/heated mirror relay
52	10A*	Anti-lock brake system (ABS) R/S feed
53	10A*	RAS module
54	5A*	TCM R/S feed
55	5A*	Fuel pump relay coil R/S feed
56	30A*	Passenger compartment fuse panel R/S feed
57	10A*	Blower motor relay coil
58	15A*	TT backup lamps
59	15A*	Heated mirrors

## Roadside Emergencies

Fuse/Relay Location	Fuse Amp Rating	Protected Circuits
60	—	One-touch start diode
61	—	Fuel pump diode
62	—	Not used
63	25A**	Electronic fan
64	30A**	Moon roof
65	20A**	Auxiliary power point (instrument panel)
66	20A**	Auxiliary power point (rear of center console)
67	40A**	Front row climate controlled seats
68	60A**	ABS valves
69	60A**	ABS pump
70	40A**	Third row power fold seat
71	20A**	Auxiliary power point/cigar lighter
72	20A**	Auxiliary power point (right rear quarter panel)
73	—	Not used
74	30A**	Driver power seat
75	20A*	Vehicle power 1 – PCM
76	20A*	Vehicle power 2 – PCM
77	15A*	Vehicle power 4 – ignition coils
78	—	Not used
79	20A*	Vehicle power 3 – PCM
80	—	Not used
81	—	Not used
82	—	Not used
83	—	Not used
84	—	Not used
85	—	Wiper motor relay

\* Mini Fuses \*\* Cartridge Fuses

## Roadside Emergencies

### CHANGING THE TIRES

If you get a flat tire while driving, do not apply the brake heavily. Instead, gradually decrease your speed. Hold the steering wheel firmly and slowly move to a safe place on the side of the road.

**Note:** The tire pressure monitoring system (TPMS) indicator light will illuminate when the spare tire is in use. To restore the full functionality of the monitoring system, all road wheels equipped with tire pressure monitoring sensors must be mounted on the vehicle.

Have a flat serviced by an authorized dealer in order to prevent damage to the TPMS sensors, refer to *Tire pressure monitoring system (TPMS)* in the *Tires, Wheels and Loading* chapter. Replace the spare tire with a road tire as soon as possible. During repairing or replacing of the flat tire, have the authorized dealer inspect the TPMS sensor for damage.



**WARNING:** The use of tire sealants may damage your tire pressure monitoring system (TPMS) and should not be used. However, if you must use a sealant, the TPMS sensor and valve stem on the wheel must be replaced by an authorized Ford dealer.



**WARNING:** Refer to *Tire pressure monitoring system (TPMS)* in the *Tires, Wheels and Loading* chapter for important information. If the tire pressure monitor sensor becomes damaged, it will no longer function.

### Dissimilar spare tire/wheel information



**WARNING:** Failure to follow these guidelines could result in an increased risk of loss of vehicle control, injury or death.

If you have a dissimilar spare tire/wheel, then it is intended for temporary use only. This means that if you need to use it, you should replace it as soon as possible with a road tire/wheel that is the same size and type as the road tires and wheels that were originally provided by Ford. If the dissimilar spare tire or wheel is damaged, it should be replaced rather than repaired.

## Roadside Emergencies

A dissimilar spare tire/wheel is defined as a spare tire and/or wheel that is different in brand, size or appearance from the road tires and wheels and can be one of three types:

1. **T-type mini-spare:** This spare tire begins with the letter “T” for tire size and may have “Temporary Use Only” molded in the sidewall
2. **Full-size dissimilar spare with label on wheel:** This spare tire has a label on the wheel that states: “THIS TIRE AND WHEEL FOR TEMPORARY USE ONLY”

When driving with one of the dissimilar spare tires listed above, **do not:**

- Exceed 50 mph (80 km/h)
- Load the vehicle beyond maximum vehicle load rating listed on the Safety Compliance Label
- Tow a trailer
- Use snow chains on the end of the vehicle with the dissimilar spare tire
- Use more than one dissimilar spare tire at a time
- Use commercial car washing equipment
- Try to repair the dissimilar spare tire

Use of one of the dissimilar spare tires listed above at any one wheel location can lead to impairment of the following:

- Handling, stability and braking performance
- Comfort and noise
- Ground clearance and parking at curbs
- Winter weather driving capability
- Wet weather driving capability

### 3. **Full-size dissimilar spare without label on wheel**

When driving with the full-size dissimilar spare tire/wheel, **do not:**

- Exceed 70 mph (113 km/h)
- Use more than one dissimilar spare tire/wheel at a time
- Use commercial car washing equipment
- Use snow chains on the end of the vehicle with the dissimilar spare tire/wheel

## Roadside Emergencies

The usage of a full-size dissimilar spare tire/wheel can lead to impairment of the following:

- Handling, stability and braking performance
- Comfort and noise
- Ground clearance and parking at curbs
- Winter weather driving capability
- Wet weather driving capability
- All-wheel driving capability (if applicable)
- Load leveling adjustment (if applicable)

When driving with the full-size dissimilar spare tire/wheel additional caution should be given to:

- Towing a trailer
- Driving vehicles equipped with a camper body
- Driving vehicles with a load on the cargo rack

Drive cautiously when using a full-size dissimilar spare tire/wheel and seek service as soon as possible.

### Stopping and securing the vehicle

1. Park on a level surface, activate the hazard flashers and set the parking brake.
2. Place the gearshift in P (Park) and turn the engine off.

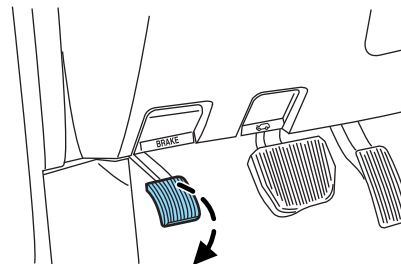



## Roadside Emergencies

### Location of the spare tire and tools

The spare tire and tools for your vehicle are stowed in the following locations:

Item	Location
Spare tire	Under the vehicle, just forward of the rear bumper
Jack tools and jacking instructions	Under the access panel located in the floor compartment behind the rear seat

### Removing the jack and tools

1. Open the liftgate, then locate the access panel on the floor behind the 3rd row seat. Unlatch and remove the panel.

2. Remove the jack and tools assembly tray from the compartment by turning the wing-nut counterclockwise to relieve tension against the jack assembly tray. Remove the bag from the jack and tool assembly tray by loosening the strap.

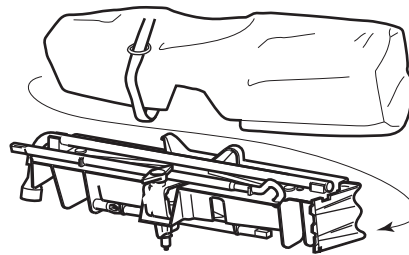

**Note:** Pay close attention to the orientation of the bag, because it will have to be reinstalled after changing the tire.

3. Unsnap the wheel lug nut wrench, jack extension and handle from the plastic tray. Remove the jack and instruction sheet from the tray assembly.

## Roadside Emergencies

### Removing the spare tire

1. Remove the jack handle and winch extension from the tray and assemble them.
2. Open the spare tire winch access plug in the bottom of the compartment for the jack and tools tray.
3. Insert the winch extension tool assembly through the access hole in the floor and engage the winch.
4. To remove the spare tire, turn the handle counterclockwise until the tire is lowered to the ground and the cable is slightly slack.
5. Slide the retainer through the center of the spare tire wheel.

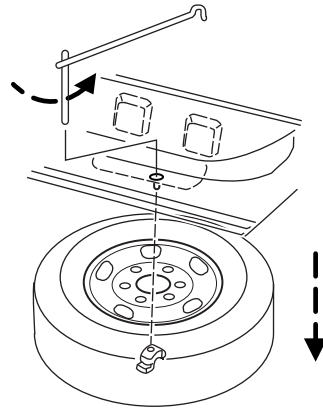

### Tire change procedure

**WARNING:** To help prevent the vehicle from moving when you change a tire, be sure the parking brake is set, then block the wheels (both front or both rear) on the opposite end of the vehicle from the wheel being changed. If on a grade, block both opposite wheels on the downward side of the hill.

**WARNING:** If the vehicle slips off the jack, you or someone else could be seriously injured.

**WARNING:** On vehicles equipped with air suspension, turn off the Air Suspension system prior to jacking, hoisting or towing your vehicle.

**WARNING:** Turn off the running boards (if equipped) before jacking or placing any object under the vehicle. Never place your hand between the extended running board and the vehicle. A moving running board may cause injury.

## Roadside Emergencies



**WARNING:** Do not attempt to change a tire on the side of the vehicle close to moving traffic. Pull far enough off the road to avoid the danger of being hit when operating the jack and changing the wheel.

**Note:** Passengers should not remain in the vehicle when the vehicle is being jacked.

If your vehicle is equipped with air suspension, refer to *Message center* in the *Instrument Cluster* chapter for instructions on turning the air suspension system off.

Refer to the instruction sheet (located in the rear floor compartment behind the 3rd row seat with the jack tray tools assembly kit) for detailed tire change instructions.

1. Block the wheels (both front or both rear) on the opposite end of the vehicle from the wheel being changed. If on a grade, block both wheels on the downward side of the hill.

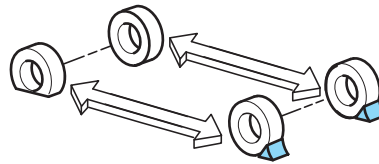

2. Turn off the air suspension system (if equipped - the air suspension system is controlled through the message center. Refer to *Air suspension system* in the *Driving* chapter for more information). Also, turn off the deployable running boards (if equipped). See *Message center* in the *Instrument Cluster* section.

3. Obtain the spare tire and jack tools from their storage locations.

4. Use the tip of the jack handle to remove any wheel trim. Loosen each wheel lug nut one-half turn counterclockwise but do not remove them until the wheel is raised off the ground.

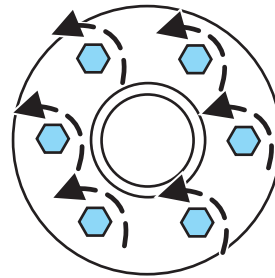

## Roadside Emergencies

5. Position the jack according to the jack locator arrows found on the frame and turn the jack handle and extension tool assembly clockwise.

**Note:** Use the frame rail as the jacking location point, NOT the control arm.

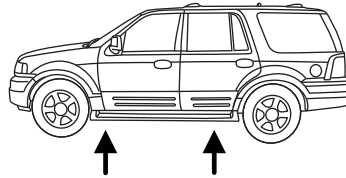

6. Raise the vehicle to provide sufficient ground clearance when installing the spare tire; approximately 1/4 in (6 mm).



**WARNING:** When one of the rear wheels is off the ground, the transmission alone will not prevent the vehicle from moving or slipping off the jack, even if the transmission is in P (Park). To prevent the vehicle from moving when you change the tire, be sure that the parking brake is set and block the wheels (both front or both rear) on the opposite end of the vehicle from the wheel being changed. If on a grade, block both opposite wheels on the downward side of the hill. If the vehicle slips off the jack, someone could be seriously injured.

- Front

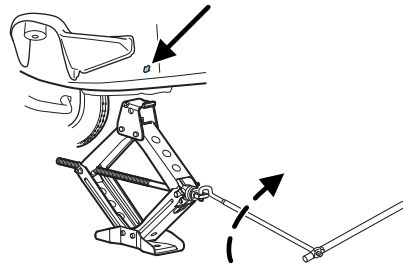

- Rear

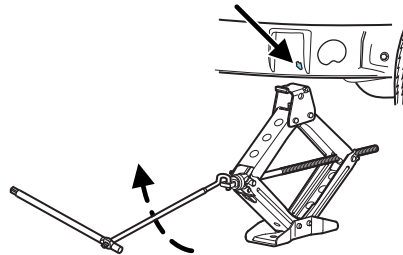

## Roadside Emergencies

 **WARNING:** Turn off the running boards (if equipped) before jacking or placing any object under the vehicle. Never place your hand between the extended running board and the vehicle. A moving running board may cause injury.

- **Never use the front or rear differential as a jacking point.**

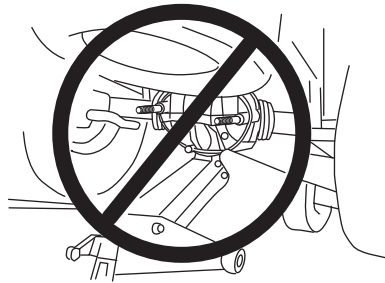

 **WARNING:** To lessen the risk of personal injury, do not put any part of your body under the vehicle while changing a tire. Do not start the engine when your vehicle is on the jack. The jack is only meant for changing the tire.

7. Remove the lug nuts with the lug wrench.
8. Replace the flat tire with the spare tire, making sure the valve stem is facing outward. Reinstall the lug nuts until the wheel is snug against the hub. Do not fully tighten the lug nuts until the wheel has been lowered.
9. Lower the wheel by turning the jack handle counterclockwise.
10. Remove the jack and fully tighten the lug nuts in the order shown and reinstall the wheel cover. Refer to *Wheel lug nut torque specifications* later in this chapter for the proper lug nut torque specification.
11. Unblock the wheels.
12. Put flat tire, jack, lug wrench and tools away. Make sure the jack bag is properly reinstalled around the jack and tools assembly tray with the strap securely fastened. Be sure to tighten the wing nut sufficiently so it does not rattle when you drive.

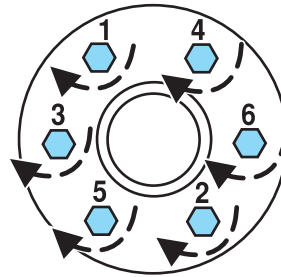

## Roadside Emergencies

13. Turn on the air suspension system (if equipped). Refer to *Message center* in the *Instrument Cluster* chapter for instructions on turning the air suspension system on.

### Stowing the spare tire

1. Lay the tire on the ground, near the rear of the vehicle, with the valve stem side facing up.

2. Slide the wheel partially under the vehicle and install the retainer through the wheel center. If equipped, you may have to remove the wheel center cap prior to pushing the retainer through the center of the wheel. To remove the center cap, press it off with the jack tool from the inner side of the wheel. After doing so, pull on the cable to align the components at the end of the cable.

3. Assemble the jack handle and winch extension (as shown in illustration), then insert the winch extension through the access hole behind the 3rd row seat and engage the winch.

4. Turn the jack handle clockwise until the tire is raised to its stowed position underneath the vehicle. The wrench will become harder to turn and the spare tire winch will ratchet or slip when the tire is raised to maximum tightness. A clicking sound will be heard from the winch indicating that the tire is properly stowed.

5. Disassemble the jack tool and winch extension and snap them back into the tool tray. Reinstall the jack bag properly around the jack and tool assembly tray, making sure the strap is securely fastened. Close the access hole with the rubber plug. Reinstall the tray into the vehicle and secure it with the wing nut (turn clockwise until tight).

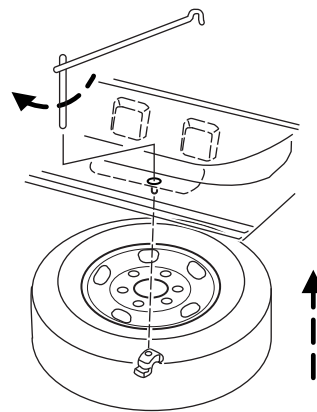

## Roadside Emergencies

### WHEEL LUG NUT TORQUE SPECIFICATIONS

Retighten the lug nuts to the specified torque within 100 miles (160 km) after any wheel disturbance (tire rotation, changing a flat tire, wheel removal, etc.).

Bolt size	Wheel lug nut torque*	
	ft-lb	N•m
M14 x 2.0	150	200

\* Torque specifications are for nut and bolt threads free of dirt and rust. Use only Ford recommended replacement fasteners.

 **WARNING:** When a wheel is installed, always remove any corrosion, dirt or foreign materials present on the mounting surfaces of the wheel or the surface of the wheel hub, brake drum or brake disc that contacts the wheel. Ensure that any fasteners that attach the rotor to the hub are secured so they do not interfere with the mounting surfaces of the wheel. Installing wheels without correct metal-to-metal contact at the wheel mounting surfaces can cause the wheel nuts to loosen and the wheel to come off while the vehicle is in motion, resulting in loss of control.

**Note:** Inspect the wheel pilot hole prior to installation. If there is visible corrosion in wheel pilot hole, remove loose particles by wiping with clean rag and apply grease. Apply grease only to the wheel pilot hole surface by smearing a “dime” (1 square cm) sized glob of grease around the wheel pilot surface (1) with end of finger. DO NOT apply grease to lugnut/stud holes or wheel-to-brake surfaces.

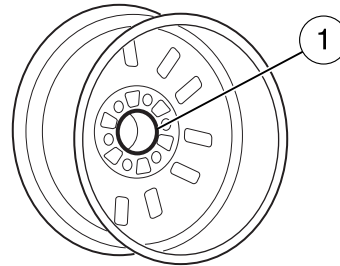

## Roadside Emergencies

### RUNNING OUT OF FUEL

If you have run out of fuel and need to refill the vehicle with a portable fuel container, see *Running out of fuel* in the *Maintenance and Specifications* chapter for proper fuel filling method using a portable fuel container and the included fuel filler funnel. **Do not** insert the nozzle of portable fuel containers or any type of aftermarket funnels into the Easy Fuel™ “no cap” fuel system as it can be damaged. You must use the included funnel in such circumstances.



**WARNING:** Do not insert the nozzle of portable fuel containers or aftermarket funnels into the Easy Fuel™ system. This could damage the fuel system and its seal, and may cause fuel to run onto the ground instead of filling the tank, all of which could result in serious personal injury.

### JUMP STARTING



**WARNING:** The gases around the battery can explode if exposed to flames, sparks, or lit cigarettes. An explosion could result in injury or vehicle damage.



**WARNING:** Batteries contain sulfuric acid which can burn skin, eyes and clothing, if contacted.

**Do not attempt to push-start your automatic transmission vehicle. Automatic transmissions do not have push-start capability. Attempting to push-start a vehicle with an automatic transmission may cause transmission damage.**

### Preparing your vehicle

When the battery is disconnected or a new battery is installed, the automatic transmission must relearn its shift strategy. As a result, the transmission may have firm and/or soft shifts. This operation is considered normal and will not affect function or durability of the transmission. Over time, the adaptive learning process will fully update transmission operation.

1. **Use only a 12-volt supply to start your vehicle.**
2. Do not disconnect the battery of the disabled vehicle as this could damage the vehicle's electrical system.



## Roadside Emergencies

3. Park the booster vehicle close to the hood of the disabled vehicle making sure the two vehicles **do not** touch. Set the parking brake on both vehicles and stay clear of the engine cooling fan and other moving parts.
4. Check all battery terminals and remove any excessive corrosion before you attach the battery cables. Ensure that vent caps are tight and level.
5. Turn the heater fan on in both vehicles to protect from any electrical surges. Turn all other accessories off.

### Connecting the jumper cables

**Note:** In the illustration, the vehicle on the bottom is used to designate the assisting (boosting) battery.

1. Connect the positive (+) jumper cable to the positive (+) terminal of the discharged battery.
2. Connect the other end of the positive (+) cable to the positive (+) terminal of the assisting battery.
3. Connect the negative (-) cable to the negative (-) terminal of the assisting battery.

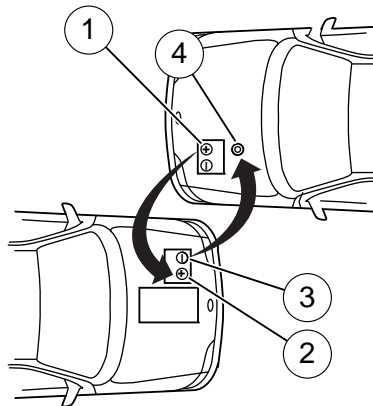

## Roadside Emergencies

4. Make the final connection of the negative (-) cable to the jump starting stud located in the engine compartment, near the washer fluid bottle.

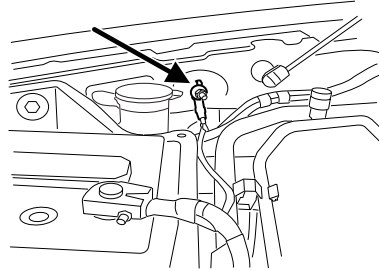

**Note:** Do not attach the negative (-) cable to fuel lines, engine rocker covers, the intake manifold or electrical components as grounding points.



**WARNING:** Do not connect the end of the second cable to the negative (-) terminal of the battery to be jumped. A spark may cause an explosion of the gases that surround the battery.

Ensure that the cables are clear of fan blades, belts, moving parts of both engines, or any fuel delivery system parts.

### Jump starting

1. Start the engine of the booster vehicle and run the engine at moderately increased speed.
2. Start the engine of the disabled vehicle.
3. Once the disabled vehicle has been started, run both engines for an additional three minutes before disconnecting the jumper cables.

### Removing the jumper cables

Remove the jumper cables in the reverse order that they were connected.

**Note:** In the illustration, the vehicle on the bottom is used to designate the assisting (boosting) battery.

## Roadside Emergencies

1. Remove the jumper cable from the jump starting stud.

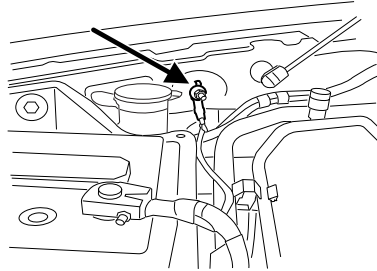

2. Remove the jumper cable on the negative (-) terminal of the booster vehicle's battery.

3. Remove the jumper cable from the positive (+) terminal of the booster vehicle's battery.

4. Remove the jumper cable from the positive (+) terminal of the disabled vehicle's battery.

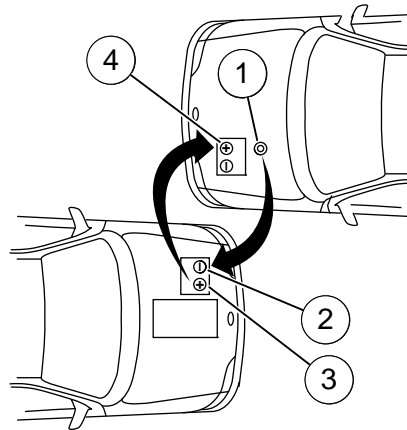

After the disabled vehicle has been started and the jumper cables removed, allow it to idle for several minutes so the engine computer can relearn its idle conditions.

## Roadside Emergencies

### WRECKER TOWING

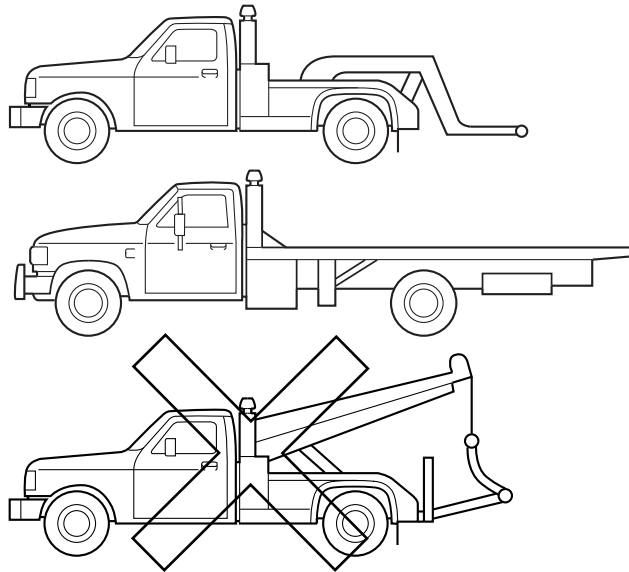

If you need to have your vehicle towed, contact a professional towing service or, if you are a member of a roadside assistance program, your roadside assistance service provider.

It is recommended that your vehicle be towed with a wheel lift or flatbed equipment. Do not tow with a slingbelt. Ford Motor Company has not approved a slingbelt towing procedure. Also, wrecker towing the vehicle by the frame-mounted tow hooks is not recommended or advised.

**Note:** If your vehicle is equipped with air suspension, the air suspension control and the ignition must be turned off before being towed. Refer to *Air suspension system* in the *Driving* chapter.

On 4x2 vehicles, it is acceptable to tow the vehicle with the front wheels on the ground (without dollies) and the rear wheels off the ground.

On 4x4 vehicles, it is required that your vehicle be towed with a wheel lift and dollies or flatbed equipment with all the wheels off the ground.

**If the vehicle is towed by other means or incorrectly, vehicle damage may occur.**

## Roadside Emergencies

Ford Motor Company produces a towing manual for all authorized tow truck operators. Have your tow truck operator refer to this manual for proper hook-up and towing procedures for your vehicle.

### Emergency towing

In case of a roadside emergency with a disabled vehicle (without access to wheel dollies, car hauling trailer, or flatbed transport vehicle) your vehicle (regardless of transmission powertrain configuration) can be flat towed (all wheels on the ground) under the following conditions:

- Vehicle is facing forward so that it is being towed in a forward direction.
- Place the transmission in N (Neutral). Refer to *Brake-shift interlock* in the *Driving* chapter for specific instructions if you cannot move the gear shift lever into N (Neutral).
- Maximum speed is not to exceed 35 mph (56 km/h).
- Maximum distance is 50 miles (80 km).

## Customer Assistance

### GETTING THE SERVICES YOU NEED

Warranty repairs to your vehicle must be performed by an authorized Ford, Lincoln, or Mercury dealer. While any authorized dealer handling your vehicle line will provide warranty service, we recommend you return to your selling authorized dealer who wants to ensure your continued satisfaction.

Please note that certain warranty repairs require special training and/or equipment, so not all authorized dealers are authorized to perform all warranty repairs. This means that, depending on the warranty repair needed, you may have to take your vehicle to another authorized dealer.

A reasonable time must be allowed to perform a repair after taking your vehicle to the authorized dealer. Repairs will be made using Ford or Motorcraft® parts, or remanufactured or other parts that are authorized by Ford.

### Away from home

If you are away from home when your vehicle needs service, contact the Ford Customer Relationship Center or use the online resources listed below to find the nearest authorized dealer.

In the United States:

#### Mailing address

Ford Motor Company  
Customer Relationship Center  
P.O. Box 6248  
Dearborn, MI 48121

#### Telephone

1-800-392-3673 (FORD)  
(TDD for the hearing impaired: 1-800-232-5952)

#### Online

Additional information and resources are available online at [www.genuineservice.com](http://www.genuineservice.com).

- U.S. dealer locator by Dealer Name, City/State, or Zip Code
- Owner Guides
- Maintenance Schedules
- Recalls
- Ford Extended Service Plans
- Ford Genuine Accessories
- Service specials and promotions.

302

<https://www.MyCarManual.com>

## Customer Assistance

In Canada:

**Mailing address (Ford vehicles)**

Customer Relationship Centre  
Ford Motor Company of Canada, Limited  
P.O. Box 2000  
Oakville, Ontario L6J 5E4

**Telephone**

1-800-565-3673 (FORD)

**Online**

[www.ford.ca](http://www.ford.ca)

**Mailing address (Lincoln vehicles)**

Lincoln Centre  
Ford Motor Company of Canada, Limited  
P.O. Box 2000  
Oakville, Ontario L6J 5E4

**Telephone**

1-800-387-9333

**Online**

[www.lincolncanada.com](http://www.lincolncanada.com)

**Additional assistance**

If you have questions or concerns, or are unsatisfied with the service you are receiving, follow these steps:

1. Contact your Sales Representative or Service Advisor at your selling/servicing authorized dealer.
2. If your inquiry or concern remains unresolved, contact the Sales Manager, Service Manager or Customer Relations Manager.
3. If you require assistance or clarification on Ford Motor Company policies, please contact the Ford Customer Relationship Center

In order to help you serve you better, please have the following information available when contacting a Customer Relationship Center:

- Vehicle Identification Number (VIN)
- Your telephone number (home and business)
- The name of the authorized dealer and city where located
- The vehicle's current odometer reading

In some states, you must directly notify Ford in writing before pursuing remedies under your state's warranty laws. Ford is also allowed a final repair attempt in some states.

<https://www.MyCarManual.com>

303

## Customer Assistance

In the United States, a warranty dispute must be submitted to the BBB AUTO LINE before taking action under the Magnuson-Moss Warranty Act, or to the extent allowed by state law, before pursuing replacement or repurchase remedies provided by certain state laws. This dispute handling procedure is not required prior to enforcing state created rights or other rights which are independent of the Magnuson-Moss Warranty Act or state replacement or repurchase laws.

### IN CALIFORNIA (U.S. ONLY)

California Civil Code Section 1793.2(d) requires that, if a manufacturer or its representative is unable to repair a motor vehicle to conform to the vehicle's applicable express warranty after a reasonable number of attempts, the manufacturer shall be required to either replace the vehicle with one substantially identical or repurchase the vehicle and reimburse the buyer in an amount equal to the actual price paid or payable by the consumer (less a reasonable allowance for consumer use). The consumer has the right to choose whether to receive a refund or replacement vehicle.

California Civil Code Section 1793.22(b) presumes that the manufacturer has had a reasonable number of attempts to conform the vehicle to its applicable express warranties if, within the first 18 months of ownership of a new vehicle or the first 18,000 miles (29,000 km), whichever occurs first:

1. Two or more repair attempts are made on the same non-conformity likely to cause death or serious bodily injury OR
2. Four or more repair attempts are made on the same nonconformity (a defect or condition that substantially impairs the use, value or safety of the vehicle) OR
3. The vehicle is out of service for repair of nonconformities for a total of more than 30 calendar days (not necessarily all at one time)

In the case of 1 or 2 above, the consumer must also notify the manufacturer of the need for the repair of the nonconformity at the following address:

Ford Motor Company  
16800 Executive Plaza Drive  
Mail Drop 3NE-B  
Dearborn, MI 48126



## Customer Assistance

You are required to submit your warranty dispute to BBB AUTO LINE before asserting in court any rights or remedies conferred by California Civil Code Section 1793.22(b). You are also required to use BBB AUTO LINE before exercising rights or seeking remedies created by the Federal Magnuson-Moss Warranty Act, 15 U.S.C. sec. 2301 et seq. If you choose to seek redress by pursuing rights and remedies not created by California Civil Code Section 1793.22(b) or the Magnuson-Moss Warranty Act, resort to BBB AUTO LINE is not required by those statutes.

### **THE BETTER BUSINESS BUREAU (BBB) AUTO LINE PROGRAM (U.S. ONLY)**

Your satisfaction is important to Ford Motor Company and to your dealer. If a warranty concern has not been resolved using the three-step procedure outlined on the first page of the *Customer Assistance* section, you may be eligible to participate in the BBB AUTO LINE program.

The BBB AUTO LINE program consists of two parts – mediation and arbitration. During mediation, a representative of the BBB will contact both you and Ford Motor Company to explore options for settlement of the claim. If an agreement is not reached during mediation or you do not want to participate in mediation, and if your claim is eligible, you may participate in the arbitration process. An arbitration hearing will be scheduled so that you can present your case in an informal setting before an impartial person. The arbitrator will consider the testimony provided and make a decision after the hearing.

Disputes submitted to the BBB AUTO LINE program are usually decided within forty days after you file your claim with the BBB. You are not bound by the decision, and may reject the decision and proceed to court where all findings of the BBB Auto Line dispute, and decision, are admissible in the court action. Should you choose to accept the BBB AUTO LINE decision, Ford is then bound by the decision, and must comply with the decision within 30 days of receipt of your acceptance letter.

BBB AUTO LINE Application: Using the information provided below, please call or write to request a program application. You will be asked for your name and address, general information about your new vehicle, information about your warranty concerns, and any steps you have already taken to try to resolve them. A Customer Claim Form will be mailed that will need to be completed, signed and returned to the BBB along with proof of ownership. Upon receipt, the BBB will review the claim for eligibility under the Program Summary Guidelines.

## Customer Assistance

**You can get more information by calling BBB AUTO LINE at 1-800-955-5100, or writing to:**

**BBB AUTO LINE  
4200 Wilson Boulevard, Suite 800  
Arlington, Virginia 22203-1833**

BBB AUTO LINE applications can also be requested by calling the Ford Motor Company Customer Relationship Center at 1-800-392-3673.

**Note:** Ford Motor Company reserves the right to change eligibility limitations, modify procedures, or to discontinue this process at any time without notice and without obligation.

### **UTILIZING THE MEDIATION/ARBITRATION PROGRAM (CANADA ONLY)**

For vehicles delivered to authorized Canadian dealers. In those cases where you continue to feel that the efforts by Ford of Canada and the authorized dealer to resolve a factory-related vehicle service concern have been unsatisfactory, Ford of Canada participates in an impartial third party mediation/arbitration program administered by the Canadian Motor Vehicle Arbitration Plan (CAMVAP).

The CAMVAP program is a straight forward and relatively speedy alternative to resolve a disagreement when all other efforts to produce a settlement have failed. This procedure is without cost to you and is designed to eliminate the need for lengthy and expensive legal proceedings.

In the CAMVAP program, impartial third-party arbitrators conduct hearings at mutually convenient times and places in an informal environment. These impartial arbitrators review the positions of the parties, make decisions and, when appropriate, render awards to resolve disputes. CAMVAP decisions are fast, fair, and final as the arbitrator's award is binding on both you and Ford of Canada.

CAMVAP services are available in all Canadian territories and provinces. For more information, without charge or obligation, call your CAMVAP Provincial Administrator directly at 1-800-207-0685 or visit [www.camvap.ca](http://www.camvap.ca).

### **GETTING ASSISTANCE OUTSIDE THE U.S. AND CANADA**

Before exporting your vehicle to a foreign country, contact the appropriate foreign embassy or consulate. These officials can inform you of local vehicle registration regulations and where to find unleaded fuel.

If you cannot find unleaded fuel or can only get fuel with an anti-knock index lower than is recommended for your vehicle, contact a regional office or owner relations/customer relationship office.

306

<https://www.MyCarManual.com>

## Customer Assistance

The use of leaded fuel in your vehicle without proper conversion may damage the effectiveness of your emission control system and may cause engine knocking or serious engine damage. Ford Motor Company/Ford of Canada is not responsible for any damage caused by use of improper fuel. Using leaded fuel may also result in difficulty importing your vehicle back into the U.S.

If your vehicle must be serviced while you are traveling or living in Asia-Pacific Region, Sub-Saharan Africa, U.S. Virgin Islands, Central America, the Caribbean, and Israel, contact the nearest authorized dealer. If the authorized dealer cannot help you, contact:

FORD MOTOR COMPANY  
FORD EXPORT OPERATIONS & GLOBAL INITIATIVES  
1555 Fairlane Drive  
Fairlane Business Park #3  
Allen Park, Michigan 48101  
U.S.A.

Telephone: (313) 594-4857

For customers in Guam, the Commonwealth of the Northern Mariana Islands (CNMI), American Samoa, and the U.S. Virgin Islands, please feel free to call our Toll-Free Number: (800) 841-FORD (3673).

FAX: (313) 390-0804

Email: [expcac@ford.com](mailto:expcac@ford.com)

If your vehicle must be serviced while you are traveling or living in Puerto Rico, contact the nearest authorized dealer. If the authorized dealer cannot help you, contact:

Ford International Business Development Inc.  
Customer Relationship Center  
P.O. Box 11957  
Caparra Heights Station  
San Juan, Puerto Rico 00922-1957  
Telephone: (800) 841-FORD (3673)  
FAX: (313) 390-0804  
Email: [prcac@ford.com](mailto:prcac@ford.com)  
[www.ford.com.pr](http://www.ford.com.pr)

## Customer Assistance

If your vehicle must be serviced while you are traveling or living in the Middle East, contact the nearest authorized dealer. If the authorized dealer cannot help you, contact:

Ford Middle East  
Customer Relationship Center  
P.O. Box 21470  
Dubai, United Arab Emirates  
Telephone: +971 4 3326084  
Toll-Free Number for the Kingdom of Saudi Arabia: 800 89717409  
Local Telephone Number for Kuwait: 24810575  
FAX: +971 4 3327299  
Email: [menacac@ford.com](mailto:menacac@ford.com)  
[www.me.ford.com](http://www.me.ford.com)

If you buy your vehicle in North America and then relocate to any of the above locations, register your vehicle identification number (VIN) and new address with Ford Motor Company Export Operations & Global Growth Initiatives by emailing [expcac@ford.com](mailto:expcac@ford.com).

If you are in another foreign country, contact the nearest authorized dealer. If the authorized dealer employees cannot help you, they can direct you to the nearest Ford affiliate office.

**Customers in the U.S. should call 1-800-392-3673.**

### ORDERING ADDITIONAL OWNER'S LITERATURE

To order the publications in this portfolio, contact Helm, Incorporated at:

HELM, INCORPORATED  
P.O. Box 07150  
Detroit, Michigan 48207

Or to order a free publication catalog, call toll free: 1-800-782-4356

Monday-Friday 8:00 a.m. - 6:00 p.m. EST

Helm, Incorporated can also be reached by their website:  
[www.helminc.com](http://www.helminc.com).

*(Items in this catalog may be purchased by credit card, check or money order.)*

### Obtaining a French Owner's Guide

French Owner's Guides can be obtained from your authorized dealer or by contacting Helm, Incorporated using the contact information listed previously in this section.

308

<https://www.MyCarManual.com>

## Customer Assistance

### REPORTING SAFETY DEFECTS (U.S. ONLY)

If you believe that your vehicle has a defect which could cause a crash or could cause injury or death, you should immediately inform the National Highway Traffic Safety



Administration (NHTSA) in addition to notifying Ford Motor Company.

If NHTSA receives similar complaints, it may open an investigation, and if it finds that a safety defect exists in a group of vehicles, it may order a recall and remedy campaign. However, NHTSA cannot become involved in individual problems between you, your dealer, or Ford Motor Company.

To contact NHTSA, you may call the Vehicle Safety Hotline toll-free at 1-888-327-4236 (TTY: 1-800-424-9153); go to <http://www.safercar.gov>; or write to:

Administrator  
1200 New Jersey Avenue, Southeast  
Washington, D.C. 20590

You can also obtain other information about motor vehicle safety from <http://www.safercar.gov>.

### REPORTING SAFETY DEFECTS (CANADA ONLY)

If you believe that your vehicle has a defect which could cause a crash or could cause injury or death, you should immediately inform Transport Canada, using their toll-free number: 1-800-333-0510, or online at: <https://wwwwapps.tc.gc.ca/Saf-Sec-Sur/7/PCDB-BDPP/Index.aspx>.

## Cleaning

### WASHING THE EXTERIOR

Wash your vehicle regularly with cool or lukewarm water and a neutral pH shampoo, such as Motorcraft® Detail Wash (ZC-3-A), which is available from your authorized dealer.

- Never use strong household detergents or soap, such as dish washing or laundry liquid. These products can discolor and spot painted surfaces.
- Never wash a vehicle that is “hot to the touch” or during exposure to strong, direct sunlight.
- Always use a clean sponge or car wash mitt with plenty of water for best results.
- Dry the vehicle with a chamois or soft terry cloth towel in order to eliminate water spotting.
- It is especially important to wash the vehicle regularly during the winter months, as dirt and road salt are difficult to remove and cause damage to the vehicle.
- Immediately remove items such as gasoline, diesel fuel, bird droppings and insect deposits because they can cause damage to the vehicle’s paintwork and trim over time. Use Motorcraft® Bug and Tar Remover (ZC-42), which is available from your authorized dealer.
- Remove any exterior accessories, such as antennas, before entering a car wash.
- **Suntan lotions and insect repellents can damage any painted surface; if these substances come in contact with your vehicle, wash off as soon as possible.**
- **If your vehicle is equipped with running boards, do not use rubber, plastic and vinyl protectant products on the running board surface, as the area may become slippery.**

### Exterior chrome

- Wash the vehicle first, using cool or lukewarm water and a neutral pH shampoo, such as Motorcraft® Detail Wash (ZC-3-A).
- Use Motorcraft® Custom Bright Metal Cleaner (ZC-15), available from your authorized dealer. Apply the product as you would a wax to clean bumpers and other chrome parts; allow the cleaner to dry for a few minutes, then wipe off the haze with a clean, dry rag.
- **Never use abrasive materials such as steel wool or plastic pads as they can scratch the chrome surface.**

### WAXING

- Wash the vehicle first.
- Use a quality wax that does not contain abrasives.
- Do not allow paint sealant to come in contact with any non-body (low-gloss black) colored trim, such as grained door handles, roof racks, bumpers, side moldings, mirror housings or the windshield cowl area. The paint sealant will “gray” or stain the parts over time.

### PAINT CHIPS

Your authorized dealer has touch-up paint to match your vehicle's color. Take your color code (printed on a sticker in the driver's door jamb) to your authorized dealer to ensure you get the correct color.

- Remove particles such as bird droppings, tree sap, insect deposits, tar spots, road salt and industrial fallout before repairing paint chips.
- Always read the instructions before using the products.

### ALUMINUM WHEELS AND WHEEL COVERS

Aluminum wheels and wheel covers are coated with a clearcoat paint finish. In order to maintain their shine:

- Clean weekly with Motorcraft® Wheel and Tire Cleaner (ZC-37-A), which is available from your authorized dealer. Heavy dirt and brake dust accumulation may require agitation with a sponge. Rinse thoroughly with a strong stream of water.
- Never apply any cleaning chemical to hot or warm wheel rims or covers.
- Some automatic car washes may cause damage to the finish on your wheel rims or covers. Industrial-strength (heavy-duty) cleaners, or cleaning chemicals, in combination with brush agitation to remove brake dust and dirt, could wear away the clearcoat finish over time.
- Do not use hydrofluoric acid-based or high caustic-based wheel cleaners, steel wool, fuels or strong household detergent.
- To remove tar and grease, use Motorcraft® Bug and Tar Remover (ZC-42), available from your authorized dealer.

## Cleaning

### ENGINE

Engines are more efficient when they are clean because grease and dirt buildup keep the engine warmer than normal. When washing:

- Take care when using a power washer to clean the engine. The high-pressure fluid could penetrate the sealed parts and cause damage.
- Do not spray a hot engine with cold water to avoid cracking the engine block or other engine components.
- Spray Motorcraft Engine Shampoo and Degreaser (ZC-20) on all parts that require cleaning and pressure rinse clean. In Canada use Motorcraft Engine Shampoo (CXC-66-A).
- Cover the highlighted areas to prevent water damage when cleaning the engine.
- Never wash or rinse the engine while it is hot or running; water in the running engine may cause internal damage.
- Never wash or rinse any ignition coil, spark plug wire or spark plug well, or the area in and around these locations.

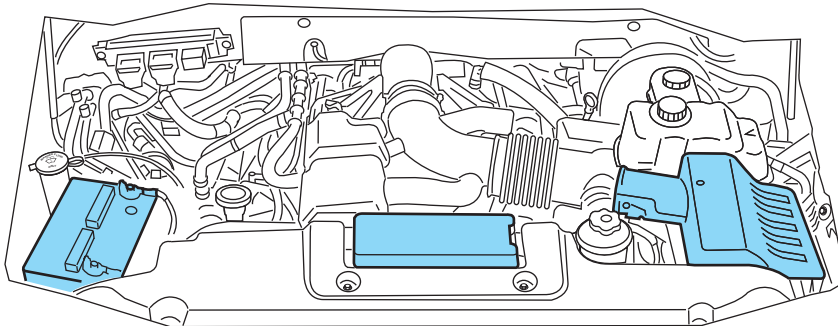

### PLASTIC (NON-PAINTED) EXTERIOR PARTS

Use only approved products to clean plastic parts. These products are available from your authorized dealer.

- For routine cleaning, use Motorcraft® Detail Wash (ZC-3-A).
- If tar or grease spots are present, use Motorcraft® Bug and Tar Remover (ZC-42).



### WINDOWS AND WIPER BLADES

The windshield, rear and side windows and the wiper blades should be cleaned regularly. If the wipers do not wipe properly, substances on the vehicle's glass or the wiper blades may be the cause. These may include hot wax treatments used by commercial car washes, water repellent coatings, tree sap, or other organic contamination; these contaminants may cause squeaking or chatter noise from the blades, and streaking and smearing of the windshield. To clean these items, follow these tips:

- The windshield, rear windows and side windows may be cleaned with a non-abrasive cleaner such as Motorcraft® Ultra-Clear Spray Glass Cleaner (ZC-23), available from your authorized dealer.
- The wiper blades can be cleaned with isopropyl (rubbing) alcohol or Motorcraft® Premium Windshield Washer Concentrate (ZC-32-A) in the U.S., or Premium Quality Windshield Washer Fluid [CXC-37-(A, B, D, or F)] in Canada, available from your authorized dealer. This washer fluid contains special solution in addition to alcohol which helps to remove the hot wax deposited on the wiper blade and windshield from automated car wash facilities. Be sure to replace wiper blades when they appear worn or do not function properly.
- Do not use abrasives, as they may cause scratches.
- Do not use fuel, kerosene, or paint thinner to clean any parts.

If you cannot remove those streaks after cleaning with the glass cleaner or if the wipers chatter and move in a jerky motion, clean the outer surface of the windshield and the wiper blades using a sponge or soft cloth with a neutral detergent or mild-abrasive cleaning solution. After cleaning, rinse the windshield and wiper blades with clean water. The windshield is clean if beads do not form when you rinse the windshield with water.

**Do not use sharp objects, such as a razor blade, to clean the inside of the rear window or to remove decals, as it may cause damage to the rear window defroster's heated grid lines.**

### INSTRUMENT PANEL/INTERIOR TRIM AND CLUSTER LENS

Clean the instrument panel, interior trim areas and cluster lens with a clean, damp, white cotton cloth, then use a clean and dry white cotton cloth to dry these areas.

- Avoid cleaners or polishes that increase the gloss of the upper portion of the instrument panel. The dull finish in this area helps protect the driver from undesirable windshield reflection.

## Cleaning

- Be certain to wash or wipe your hands clean if you have been in contact with certain products such as insect repellent and suntan lotion in order to avoid possible damage to the interior painted surfaces.
- Do not use household or glass cleaners as these may damage the finish of the instrument panel, interior trim and cluster lens.
- Do not allow air fresheners and hand sanitizers to spill on interior surfaces. If a spill occurs, **wipe off immediately**. Damage may not be covered by your warranty.



**WARNING:** Do not use chemical solvents or strong detergents when cleaning the steering wheel or instrument panel to avoid contamination of the airbag system.

If a staining liquid like coffee/juice has been spilled on the instrument panel or on interior trim surfaces, clean as follows:

1. Wipe up spilled liquid using a clean, white, cotton cloth.
2. Wipe the surface with a damp, clean, white cotton cloth. For more thorough cleaning, use a mild soap and water solution. If the spot cannot be completely cleaned by this method, the area may be cleaned using a commercially available cleaning product designed for automotive interiors.
3. If necessary, apply more soap and water solution or cleaning product to a clean, white, cotton cloth and press the cloth onto the soiled area—allow this to set at room temperature for 30 minutes.
4. Remove the soaked cloth, and if it is not soiled badly, use this cloth to clean the area by using a rubbing motion for 60 seconds.
5. Following this, wipe area dry with a clean, white, cotton cloth.

### INTERIOR

For fabric, carpets, cloth seats, safety belts and seats equipped with side airbags:

- Remove dust and loose dirt with a vacuum cleaner.
- Remove light stains and soil with Motorcraft® Professional Strength Carpet & Upholstery Cleaner (ZC-54).
- If grease or tar is present on the material, spot-clean the area first with Motorcraft® Spot and Stain Remover (ZC-14). In Canada, use Motorcraft® Multi-Purpose Cleaner (CXC-101).

## Cleaning

- If a ring forms on the fabric after spot cleaning, clean the entire area immediately (but do not oversaturate) or the ring will set.
- Do not use household cleaning products or glass cleaners, which can stain and discolor the fabric and affect the flame retardant abilities of the seat materials.



**WARNING:** Do not use cleaning solvents, bleach or dye on the vehicle's safety belts, as these actions may weaken the belt webbing.



**WARNING:** On vehicles equipped with seat-mounted airbags, do not use chemical solvents or strong detergents. Such products could contaminate the side-airbag system and affect performance of the side airbag in a collision.

### CLEANING THE CLIMATE CONTROLLED SEATS (IF EQUIPPED)

Remove dust and loose dirt with a whisk broom or a vacuum cleaner. Remove fresh spots immediately. Clean the seat with a damp cloth, using a mild soap and water solution, if necessary.

### LEATHER SEATS (IF EQUIPPED, EXCEPT FOR THE KING RANCH® EDITION)

**For King Ranch® leather seats, refer to a separate section in this chapter.**

- Clean spills and stains as quickly as possible.
- For routine cleaning, wipe the surface with a soft, damp cloth. For more thorough cleaning, wipe the surface with a mild soap and water solution. In Canada, use Motorcraft® Vinyl Cleaner (CXC-93). Dry the area with a soft cloth.
- If the leather cannot be completely cleaned using a mild soap and water solution, the leather may be cleaned using a commercially available leather cleaning product designed for automotive interiors.
- To check for compatibility, first test any cleaner or stain remover on an inconspicuous part of the leather.
- Do not use household cleaning products, alcohol solutions, solvents or cleaners intended for rubber, vinyl and plastics, or oil/petroleum-based leather conditioners. These products may cause premature wearing or damage to the leather.

## Cleaning

### LEATHER SEATS FOR THE KING RANCH® EDITION ONLY (IF EQUIPPED)

Your vehicle is equipped with seating covered in premium, top-grain leather which is extremely durable, but still requires special care and maintenance in order to ensure longevity and comfort.

Regular cleaning and conditioning will maintain the appearance of the leather.

#### Cleaning

For dirt, use a vacuum cleaner then use a clean, damp cloth or soft brush.

For routine cleaning, wipe the surface with a soft, damp cloth. For more thorough cleaning, wipe the surface with a mild soap and water solution.

- Clean spills as quickly as possible.
- Test any cleaner or stain remover on an inconspicuous part of the leather as cleaners may darken the leather.
- Do not spill coffee, ketchup, mustard, orange juice or oil-based products on the leather as they may permanently stain the leather.
- Do not use household cleaning products, alcohol solutions, solvents or cleaners intended for rubber, vinyl or plastics.

#### Scratches

Natural Markings - Because the leather in the seat comes from genuine steer hides, there will be evidence of naturally occurring markings, such as small scars. These markings give character to the seating covers and should be considered as proof of a genuine leather product.

In order to lessen the appearance of certain scratches and other wear marks, apply conditioner on the affected area following the same instructions as in the *Conditioning* section.

#### Conditioning

Bottles of King Ranch® Leather Conditioner are available at the King Ranch® Saddle Shop. Visit the website at [www.krsaddleshop.com](http://www.krsaddleshop.com), or telephone (in the United States) 1-800-282-KING (5464). If you are unable to obtain King Ranch® Leather Conditioner, use another premium leather conditioner.

- Clean the surfaces using the steps outlined in the *Cleaning* section.
- Ensure the leather is dry then apply a nickel-sized amount of conditioner to a clean, dry cloth.
- Rub the conditioner into leather until it disappears. Allow the conditioner to dry and repeat the process for the entire interior. If a film appears, wipe off film with a dry, clean cloth.

### UNDERBODY

Flush the complete underside of your vehicle frequently. Keep body and door drain holes free from packed dirt.

### FORD AND LINCOLN MERCURY CAR CARE PRODUCTS

Your Ford or Lincoln Mercury authorized dealer has many quality products available to clean your vehicle and protect its finishes. These quality products have been specifically engineered to fulfill your automotive needs; they are custom designed to complement the style and appearance of your vehicle. Each product is made from high quality materials that meet or exceed rigid specifications. For best results, use the following products or products of equivalent quality:

- Motorcraft® Bug and Tar Remover (ZC-42)
- Motorcraft® Custom Bright Metal Cleaner (ZC-15)
- Motorcraft® Detail Wash (ZC-3-A)
- Motorcraft® Dusting Cloth (ZC-24)
- Motorcraft® Engine Shampoo and Degreaser (U.S. only) (ZC-20)
- Motorcraft® Engine Shampoo (Canada only) (CXC-66-A)
- Motorcraft® Multi-Purpose Cleaner (Canada only) (CXC-101)
- Motorcraft® Premium Glass Cleaner (Canada only) (CXC-100)
- Motorcraft® Premium Quality Windshield Washer Fluid (Canada only) [CXC-37-(A, B, D or F)]
- Motorcraft® Premium Windshield Washer Concentrate (U.S. only) (ZC-32-A)
- Motorcraft® Professional Strength Carpet & Upholstery Cleaner (ZC-54)
- Motorcraft® Spot and Stain Remover (U.S. only) (ZC-14)
- Motorcraft® Ultra-Clear Spray Glass Cleaner (ZC-23)
- Motorcraft® Vinyl Cleaner (Canada only) (CXC-93)
- Motorcraft® Wheel and Tire Cleaner (ZC-37-A)

## Maintenance and Specifications

### SERVICE RECOMMENDATIONS

To help you service your vehicle, we provide *scheduled maintenance information* which makes tracking routine service easy.

If your vehicle requires professional service, your authorized dealer can provide the necessary parts and service. Check your *Warranty Guide* to find out which parts and services are covered.

Use only recommended fuels, lubricants, fluids and service parts conforming to specifications. Motorcraft® parts are designed and built to provide the best performance in your vehicle.

### PRECAUTIONS WHEN SERVICING YOUR VEHICLE

- Do not work on a hot engine.
- Make sure that nothing gets caught in moving parts.
- Do not work on a vehicle with the engine running in an enclosed space, unless you are sure you have enough ventilation.
- Keep all open flames and other lit material away from the battery and all fuel related parts.



**WARNING:** Turn off the power running boards, if equipped, before working under the vehicle, jacking or placing any object under the vehicle. Never place your hand between the extended running board and the vehicle. A moving running board may cause injury.

### Working with the engine off

1. Set the parking brake and ensure the gearshift is securely latched in P (Park).
2. Turn off the engine and remove the key.
3. Block the wheels to prevent the vehicle from moving unexpectedly.

### Working with the engine on

1. Set the parking brake and shift to P (Park).
2. Block the wheels.



**WARNING:** To reduce the risk of vehicle damage and/or personal burn injuries, do not start your engine with the air cleaner removed and do not remove it while the engine is running.

## Maintenance and Specifications

### OPENING THE HOOD

1. Inside the vehicle, pull the hood release handle located under the bottom of the instrument panel.
2. Go to the front of the vehicle and release the auxiliary latch that is located under the front center of the hood.
3. Lift the hood until the lift cylinders hold it open.

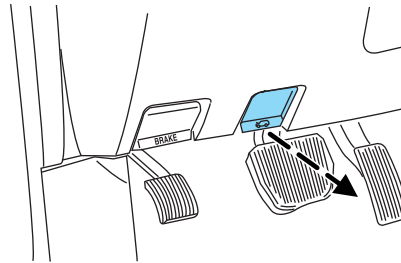

## Maintenance and Specifications

### IDENTIFYING COMPONENTS IN THE ENGINE COMPARTMENT

#### 5.4L V8

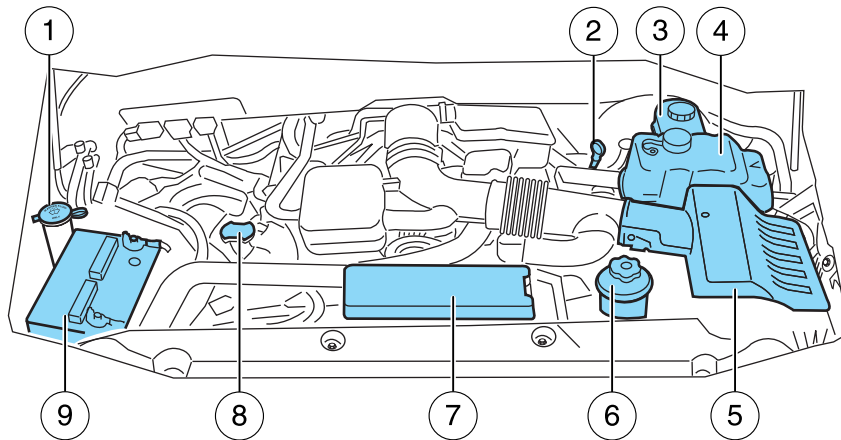

1. Windshield washer fluid reservoir
2. Engine oil dipstick
3. Brake fluid reservoir
4. Engine coolant reservoir
5. Air filter assembly
6. Power steering fluid reservoir
7. Power distribution box
8. Engine oil filler cap
9. Battery



## Maintenance and Specifications

### WINDSHIELD WASHER FLUID

Add fluid to fill the reservoir if the level is low. In very cold weather, do not fill the reservoir completely.

Only use a washer fluid that meets Ford specifications. Do not use any special washer fluid such as windshield water repellent type fluid or bug wash. They may cause squeaking, chatter noise, streaking and smearing. Refer to *Maintenance product specifications and capacities* in this chapter.

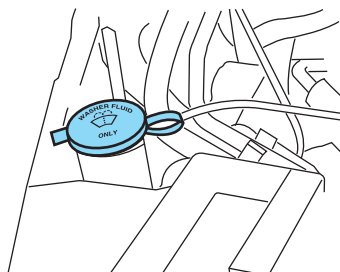

State or local regulations on volatile organic compounds may restrict the use of methanol, a common windshield washer antifreeze additive. Washer fluids containing non-methanol antifreeze agents should be used only if they provide cold weather protection without damaging the vehicle's paint finish, wiper blades or washer system.



**WARNING:** If you operate your vehicle in temperatures below 40°F (5°C), use washer fluid with antifreeze protection. Failure to use washer fluid with antifreeze protection in cold weather could result in impaired windshield vision and increase the risk of injury or accident.

### Checking and adding washer fluid for the liftgate

Washer fluid for the liftgate is supplied by the same reservoir as the windshield.

## Maintenance and Specifications

### CHANGING THE WIPER BLADES

Replace wiper blades at least once per year for optimum performance.

To replace the wiper blades:

1. Fold back the wiper arm and position the wiper blade at right angles to the wiper arm.
2. To remove, press the retaining clip (A) to disengage the wiper blade, then pull the blade down toward the windshield to remove it from the arm.
3. Install the new wiper blade on the arm and press it into place until a click is heard.

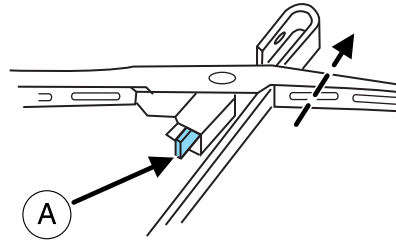

Poor wiper quality can be improved by cleaning the wiper blades and windshield. Refer to *Windows and wiper blades* in the *Cleaning* chapter.

To prolong the life of the wiper blades, it is highly recommended to scrape off the ice on the windshield before turning on the wipers. The layer of ice has many sharp edges and can damage the micro edge of the wiper rubber element.

### Changing the rear window wiper blade

To replace the rear wiper blade:

1. Pull the wiper arm as far away from the glass as possible. Do not use excessive force because it can break the wiper arm. Hold it there until the next step.
2. Grasp the wiper blade and rotate it away from the wiper arm using moderate force until it disengages from the wiper arm.
3. Once the wiper blade is loose, slide it away from the wiper arm.

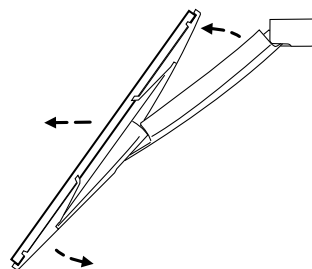

## Maintenance and Specifications

4. To attach the new wiper to the wiper arm, align the cross pin and keyway (denoted with the arrows) and firmly press the wiper blade into the wiper arm until an audible snap is heard.

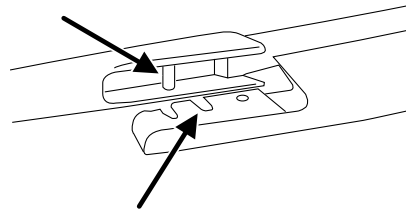

If you find this procedure too difficult, please see your dealer.

### ENGINE OIL

#### Checking the engine oil

Refer to the *scheduled maintenance information* for the appropriate intervals for checking the engine oil.

1. Make sure the vehicle is on level ground.
2. Turn the engine off and wait 15 minutes for the oil to drain into the oil pan.
3. Set the parking brake and ensure the gearshift is securely latched in P (Park).
4. Open the hood. Protect yourself from engine heat.
5. Locate and carefully remove the engine oil level dipstick.

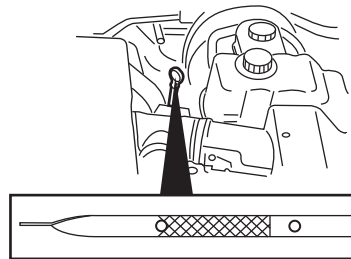

6. Wipe the dipstick clean. Insert the dipstick fully, then remove it again.
  - If the oil level is **within this range**, the oil level is acceptable. **DO NOT ADD OIL.**

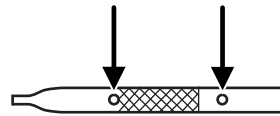

## Maintenance and Specifications

- If the oil level is **below this mark**, engine **oil must be added** to raise the level within the normal operating range.

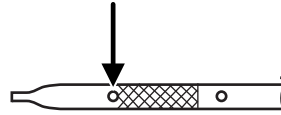

- If required, add engine oil to the engine. Refer to *Adding engine oil* in this chapter.
- **Do not overfill the engine with oil. Oil levels above this mark may cause engine damage.** If the engine is overfilled, some oil must be removed from the engine by an authorized dealer.

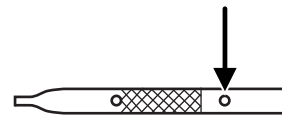

7. Put the dipstick back in and ensure it is fully seated.

### Adding engine oil

1. Check the engine oil. For instructions, refer to *Checking the engine oil* in this chapter.
2. If the engine oil level is not within the normal range, add only certified engine oil of the recommended viscosity. Remove the engine oil filler cap and use a funnel to pour the engine oil into the opening.
3. Recheck the engine oil level. Make sure the oil level is not above the upper hole or the MAX mark on the engine oil level dipstick.
4. Install the dipstick and ensure it is fully seated.
5. Fully install the engine oil filler cap by turning the filler cap clockwise 1/4 of a turn until the cap is fully seated.

**To avoid possible oil loss, DO NOT operate the vehicle with the engine oil level dipstick and/or the engine oil filler cap removed.**

## Maintenance and Specifications

### Engine oil and filter recommendations

Look for this certification trademark.

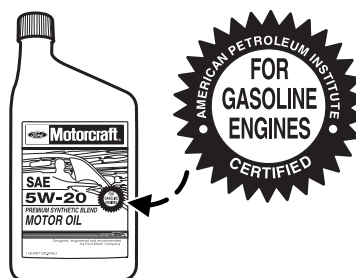

### Use SAE 5W-20 engine oil

Only use oils certified for gasoline engines by the American Petroleum Institute (API). An oil with this trademark symbol conforms to the current engine and emission system protection standards and fuel economy requirements of the International Lubricant Standardization and Approval Committee (ILSAC), comprised of U.S. and Japanese automobile manufacturers.

To protect your engine and engine's warranty, use Motorcraft® SAE 5W-20 or an equivalent SAE 5W-20 oil meeting Ford specification WSS-M2C930-A. **SAE 5W-20 oil provides optimum fuel economy and durability performance meeting all requirements for your vehicle's engine.** Refer to *Maintenance product specifications and capacities* later in this chapter for more information.

Do not use supplemental engine oil additives, cleaners or other engine treatments. They are unnecessary and could lead to engine damage that is not covered by Ford warranty.

Change your engine oil and filter according to the appropriate schedule listed in the *scheduled maintenance information*.

Ford production and Motorcraft® replacement oil filters are designed for added engine protection and long life. If a replacement oil filter is used that does not meet Ford material and design specifications, start-up engine noises or knock may be experienced.

It is recommended you use the appropriate Motorcraft® oil filter or another with equivalent performance for your engine application.

## Maintenance and Specifications

### BATTERY

Your vehicle is equipped with a Motorcraft® maintenance-free battery which normally does not require additional water during its life of service.

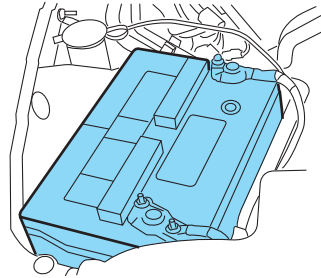

**If your battery has a cover/shield, make sure it is reinstalled after the battery has been cleaned or replaced.**

For longer, trouble-free operation, keep the top of the battery clean and dry. Also, make certain the battery cables are always tightly fastened to the battery terminals.

If you see any corrosion on the battery or terminals, remove the cables from the terminals and clean with a wire brush. You can neutralize the acid with a solution of baking soda and water.

It is recommended that the negative battery cable terminal be disconnected from the battery if you plan to store your vehicle for an extended period of time. This will minimize the discharge of your battery during storage.

**Note:** Electrical or electronic accessories or components added to the vehicle by the dealer or the owner may adversely affect battery performance and durability.





**WARNING:** Batteries normally produce explosive gases which can cause personal injury. Therefore, do not allow flames, sparks or lighted substances to come near the battery. When working near the battery, always shield your face and protect your eyes. Always provide proper ventilation.



**WARNING:** When lifting a plastic-cased battery, excessive pressure on the end walls could cause acid to flow through the vent caps, resulting in personal injury and/or damage to the vehicle or battery. Lift the battery with a battery carrier or with your hands on opposite corners.

## Maintenance and Specifications

 **WARNING:** Keep batteries out of reach of children. Batteries contain sulfuric acid. Avoid contact with skin, eyes or clothing. Shield your eyes when working near the battery to protect against possible splashing of acid solution. In case of acid contact with skin or eyes, flush immediately with water for a minimum of 15 minutes and get prompt medical attention. If acid is swallowed, call a physician immediately.

 **WARNING:** Battery posts, terminals and related accessories contain lead and lead compounds. **Wash hands after handling.**

To account for customer driving habits and conditions, your automatic transmission electronically controls the shift quality by using an adaptive learning strategy. The adaptive learning strategy is maintained by power from the battery. When the battery is disconnected or a new battery is installed, the transmission must relearn its adaptive strategy. Optimal shifting will resume within a few hundred miles (kilometers) of operation.

**If the shift quality does not improve within a few hundred miles (kilometers) of operation, or if the downshifts and other throttle conditions do not function normally or after a long deceleration period, see your authorized dealer or a qualified service technician as soon as possible.**

Because your vehicle's engine is also electronically controlled by a computer, some control conditions are maintained by power from the battery. When the battery is disconnected or a new battery is installed, the engine must relearn its idle and fuel trim strategy for optimum driveability and performance. To begin this process:

1. With the vehicle at a complete stop, set the parking brake.
  2. Put the gearshift in P (Park), turn off all accessories and start the engine.
  3. Run the engine until it reaches normal operating temperature.
  4. Allow the engine to idle for at least one minute.
  5. Turn the A/C on and allow the engine to idle for at least one minute.
  6. With your foot on the brake pedal and with the A/C on, put the vehicle in D (Drive) and allow the engine to idle for at least one minute.
  7. Drive the vehicle to complete the relearning process.
- The vehicle may need to be driven 10 miles (16 km) or more to relearn the idle and fuel trim strategy.

## Maintenance and Specifications

- **If you do not allow the engine to relearn its idle trim, the idle quality of your vehicle may be adversely affected until the idle trim is eventually relearned.**

If the battery has been disconnected or a new battery has been installed, the clock and the preset radio stations must be reset once the battery is reconnected.

- Always dispose of automotive batteries in a responsible manner. Follow your local authorized standards for disposal. Call your local authorized recycling center to find out more about recycling automotive batteries.

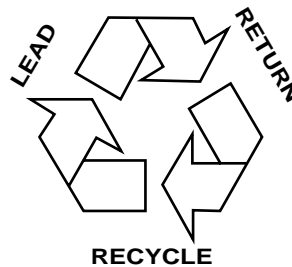

### ENGINE COOLANT

#### Checking engine coolant

The concentration and level of engine coolant should be checked at the intervals listed in *scheduled maintenance information*. The coolant concentration should be maintained at 50/50 coolant and distilled water, which equates to a freeze point of  $-34^{\circ}\text{F}$  ( $-36^{\circ}\text{C}$ ). Coolant concentration testing is possible with a hydrometer or antifreeze tester. The level of coolant should be maintained at the FULL COLD level or within the COLD FILL RANGE in the coolant reservoir. If the level falls below, add coolant per the instructions in the *Adding engine coolant* section.

Your vehicle was factory-filled with a 50/50 engine coolant and water concentration. If the concentration of coolant falls below 40% or above 60%, the engine parts could become damaged or not work properly. **A 50/50 mixture of coolant and water provides the following:**

- **Freeze protection down to  $-34^{\circ}\text{F}$  ( $-36^{\circ}\text{C}$ ).**
- **Boiling protection up to  $265^{\circ}\text{F}$  ( $129^{\circ}\text{C}$ ).**
- **Protection against rust and other forms of corrosion.**
- **Proper function of calibrated gauges.**



## Maintenance and Specifications

When the engine is cold, check the level of the engine coolant in the reservoir.

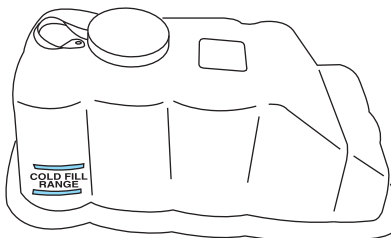

- The engine coolant should be at the FULL COLD level, or within the COLD FILL or MIN / MAX range as listed on the engine coolant reservoir (depending upon application).
- Refer to *scheduled maintenance information* for service interval schedules.

If the engine coolant has not been checked at the recommended interval, the engine coolant reservoir may become low or empty. If the reservoir is low or empty, add engine coolant to the reservoir. Refer to *Adding engine coolant* in this chapter.

**Note:** Automotive fluids are not interchangeable; do not use engine coolant/antifreeze or windshield washer fluid outside of its specified function and vehicle location.

### Adding engine coolant

When adding coolant, make sure it is a 50/50 mixture of engine coolant and distilled water. Add the mixture to the coolant reservoir, **when the engine is cool**, until the appropriate fill level is obtained. If coolant is filled to the COLD FILL RANGE or FULL COLD level when the engine is not cool, the system will remain underfilled.



**WARNING:** Do not add engine coolant when the engine is hot. Steam and scalding liquids released from a hot cooling system can burn you badly. Also, you can be burned if you spill coolant on hot engine parts.



**WARNING:** Do not put engine coolant in the windshield washer fluid container. If sprayed on the windshield, engine coolant could make it difficult to see through the windshield.

## Maintenance and Specifications

- **DO NOT MIX** different colors or types of coolant in your vehicle. Make sure the correct coolant is used. **DO NOT MIX** recycled coolant and new (unused) coolant together in the vehicle. Mixing of engine coolants may harm your engine's cooling system. The use of an improper coolant may harm engine and cooling system components and may void the warranty. Refer to *Maintenance product specifications and capacities* in this chapter.
- A large amount of water without engine coolant may be added, in case of emergency, to reach a vehicle service location. In this instance, the cooling system must be drained and refilled with a 50/50 mixture of engine coolant and distilled water as soon as possible. Water alone (without engine coolant) can cause engine damage from corrosion, overheating or freezing.
- **Do not use alcohol, methanol, brine or any engine coolants mixed with alcohol or methanol antifreeze (coolant).** Alcohol and other liquids can cause engine damage from overheating or freezing.
- **Do not add extra inhibitors or additives to the coolant.** These can be harmful and compromise the corrosion protection of the engine coolant.

For vehicles with overflow coolant systems with a non-pressurized cap on the coolant recovery system, add coolant to the coolant recovery reservoir when the engine is cool. Add the proper mixture of coolant and distilled water to the FULL COLD level. For all other vehicles which have a coolant degas system with a pressurized cap, or if it is necessary to remove the coolant pressure relief cap on the radiator of a vehicle with an overflow system, follow these steps to add engine coolant.



**WARNING:** To reduce the risk of personal injury, make sure the engine is cool before unscrewing the coolant pressure relief cap. The cooling system is under pressure; steam and hot liquid can come out forcefully when the cap is loosened slightly.

Add the proper mixture of coolant and water to the cooling system by following these steps:

1. Before you begin, turn the engine off and let it cool.
2. When the engine is cool, wrap a thick cloth around the coolant pressure relief cap on the coolant reservoir (a translucent plastic bottle). Slowly turn cap counterclockwise (left) until pressure begins to release.
3. Step back while the pressure releases.
4. When you are sure that all the pressure has been released, use the cloth to turn it counterclockwise and remove the cap.

## Maintenance and Specifications

5. Fill the coolant reservoir slowly with the proper coolant mixture, to within the COLD FILL RANGE or the FULL COLD level on the reservoir. If you removed the radiator cap in an overflow system, fill the radiator until the coolant is visible and radiator is almost full.

6. Replace the cap. Turn until tightly installed. Cap must be tightly installed to prevent coolant loss.

After any coolant has been added, check the coolant concentration (refer to *Checking engine coolant*). If the concentration is not 50/50 (protection to  $-34^{\circ}\text{F}/-36^{\circ}\text{C}$ ), drain some coolant and adjust the concentration. It may take several drains and additions to obtain a 50/50 coolant concentration.

Whenever coolant has been added, the coolant level in the coolant reservoir should be checked the next few times you drive the vehicle. If necessary, add enough 50/50 concentration of engine coolant and distilled water to bring the liquid level to the proper level.

If you have to add more than 1.0 quart (1.0 liter) of engine coolant per month, have your authorized dealer check the engine cooling system. Your cooling system may have a leak. Operating an engine with a low level of coolant can result in engine overheating and possible engine damage.

### Recycled engine coolant

Ford Motor Company does NOT recommend the use of recycled engine coolant since a Ford-approved recycling process is not yet available.



Used engine coolant should be disposed of in an appropriate manner. Follow your community's regulations and standards for recycling and disposing of automotive fluids.

### Coolant refill capacity

To find out how much fluid your vehicle's cooling system can hold, refer to *Maintenance product specifications and capacities* in this chapter.

Fill your engine coolant reservoir as outlined in *Adding engine coolant* in this section.

### Severe climates

If you drive in extremely cold climates (less than  $-34^{\circ}\text{F}$  [ $-36^{\circ}\text{C}$ ]):

- **It may be necessary to increase the coolant concentration above 50%.**
- **NEVER increase the coolant concentration above 60%.**

## Maintenance and Specifications

- **A coolant concentration of 60% will provide freeze point protection down to -62°F [-52°C]. Increased engine coolant concentrations above 60% will decrease the overheat protection characteristics of the engine coolant and may cause engine damage.**
- **If available, refer to the chart on the coolant container to ensure the coolant concentration in your vehicle will provide adequate freeze protection at the temperatures in which you drive in the winter months.**

If you drive in extremely hot climates:

- **It is still necessary to maintain the coolant concentration above 40%.**
- **NEVER decrease the coolant concentration below 40%.**
- **A coolant concentration of 40% will provide freeze point protection down to -12°F [-24°C]. Decreased engine coolant concentrations below 40% will decrease the corrosion/freeze protection characteristics of the engine coolant and may cause engine damage.**
- **If available, refer to the chart on the coolant container to ensure the coolant concentration in your vehicle will provide adequate protection at the temperatures in which you drive.**



Vehicles driven year-round in non-extreme climates should use a 50/50 mixture of engine coolant and distilled water for optimum cooling system and engine protection.

### What you should know about fail-safe cooling

If the engine coolant supply is depleted, this feature allows the vehicle to be driven temporarily before incremental component damage is incurred. The “fail-safe” distance depends on ambient temperatures, vehicle load and terrain.

#### ***How fail-safe cooling works***

If the engine begins to overheat:

- The engine coolant temperature gauge will move to the red (hot) area.
- The engine coolant temperature  symbol will illuminate.
- The  indicator light will illuminate.

If the engine reaches a preset over-temperature condition, the engine will automatically switch to alternating cylinder operation. Each disabled cylinder acts as an air pump and cools the engine.

## Maintenance and Specifications

When this occurs the vehicle will still operate. However:

- The engine power will be limited.
- The air conditioning system will be disabled.

Continued operation will increase the engine temperature:

- The engine will completely shut down.
- Steering and braking effort will increase.

Once the engine temperature cools, the engine can be re-started. Take your vehicle to an authorized dealer as soon as possible to minimize engine damage.

### ***When fail-safe mode is activated***

You have limited engine power when in the fail-safe mode, so drive the vehicle with caution. The vehicle will not be able to maintain high speed operation and the engine will run rough. Remember that the engine is capable of completely shutting down automatically to prevent engine damage, therefore:

1. Pull off the road as soon as safely possible and turn off the engine.
2. Arrange for the vehicle to be taken to an authorized dealer.
3. If this is not possible, wait a short period for the engine to cool.
4. Check the coolant level and replenish if low.



**WARNING:** Fail-safe mode is for use during emergencies only.

Operate the vehicle in fail-safe mode only as long as necessary to bring the vehicle to rest in a safe location and seek immediate repairs. When in fail-safe mode, the vehicle will have limited power, will not be able to maintain high-speed operation, and may completely shut down without warning, potentially losing engine power, power steering assist, and power brake assist, which may increase the possibility of a crash resulting in serious injury.



**WARNING:** Never remove the coolant reservoir cap while the engine is running or hot.

5. Restart the engine and take your vehicle to an authorized dealer.

**Driving the vehicle without repairing the engine problem increases the chance of engine damage. Take your vehicle to an authorized dealer as soon as possible.**

## Maintenance and Specifications

### FUEL FILTER

Your vehicle is equipped with a lifetime fuel filter that is integrated with the fuel tank. Regular maintenance or replacement is not needed.

### WHAT YOU SHOULD KNOW ABOUT AUTOMOTIVE FUELS

#### Important safety precautions



**WARNING:** Do not overfill the fuel tank. The pressure in an overfilled tank may cause leakage and lead to fuel spray and fire.



**WARNING:** The fuel system may be under pressure. If you hear a hissing sound near the fuel filler door (Easy Fuel™ “no cap” fuel system), do not refuel until the sound stops. Otherwise, fuel may spray out, which could cause serious personal injury.



**WARNING:** Automotive fuels can cause serious injury or death if misused or mishandled.



**WARNING:** Fuel ethanol and gasoline may contain benzene, which is a cancer-causing agent.

Observe the following guidelines when handling automotive fuel:

- Extinguish all smoking materials and any open flames before fueling your vehicle.
- Always turn off the vehicle before fueling.
- Automotive fuels can be harmful or fatal if swallowed. Fuels such as gasoline and ethanol are highly toxic and if swallowed can cause death or permanent injury. If fuel is swallowed, call a physician immediately, even if no symptoms are immediately apparent. The toxic effects of fuel may not be visible for hours.
- Avoid inhaling fuel vapors. Inhaling too much fuel vapor of any kind can lead to eye and respiratory tract irritation. In severe cases, excessive or prolonged breathing of fuel vapor can cause serious illness and permanent injury.



## Maintenance and Specifications

- Avoid getting fuel liquid in your eyes. If fuel is splashed in the eyes, remove contact lenses (if worn), flush with water for 15 minutes and seek medical attention. Failure to seek proper medical attention could lead to permanent injury.
- Fuels can also be harmful if absorbed through the skin. If fuel is splashed on the skin and/or clothing, promptly remove contaminated clothing and wash skin thoroughly with soap and water. Repeated or prolonged skin contact with fuel liquid or vapor causes skin irritation.
- Be particularly careful if you are taking “Antabuse” or other forms of disulfiram for the treatment of alcoholism. Breathing gasoline and/or ethanol vapors, or skin contact could cause an adverse reaction. In sensitive individuals, serious personal injury or sickness may result. If fuel is splashed on the skin, promptly wash skin thoroughly with soap and water. Consult a physician immediately if you experience an adverse reaction.
- FFV fuel tanks may contain zero to 85% ethanol. Any fuel blends containing gasoline and ethanol should be treated the same as “Fuel Ethanol.” Flex fuel vehicles have a yellow bezel placed over the fuel fill inlet.

Pure ethanol is the alcohol which is the intoxicating agent in liquor, beer and wine. It is distilled from the fermentation of plants such as field corn and sugar cane. When ethanol is produced for use in motor fuels, a small amount of gasoline is added to make it unfit for beverage use. The resulting ethanol blend is called denatured fuel ethanol meaning that it is denatured with 2% to 5% gasoline and is suitable for automotive use.

During the summer season, fuel ethanol may contain a maximum of 85% denatured ethanol (Ed85) and 15% unleaded gasoline. The fuel ethanol has a higher octane rating than unleaded regular or premium gasoline and this allows the design of engines with greater efficiency and power.

Winter blends may contain up to 75% denatured ethanol (Ed75) and up to 25% unleaded gasoline to enhance cold engine starts. Severely cold weather may require additional measures for reliable starting.

Ethanol is more chemically active than gasoline. It corrodes some metals and causes some plastic and rubber components to swell, break down or become brittle and crack, especially when mixed with gasoline. Special materials and procedures have been developed for flexible fuel vehicles and the dispensers used by ethanol fuel providers.

## Maintenance and Specifications

 **WARNING:** Flexible fuel components and standard unleaded gasoline fuel components are not interchangeable. If your vehicle is not serviced in accordance with flexible fuel vehicles procedures, damage may occur and your warranty may be invalidated.

 **WARNING:** When refueling always shut the engine off and never allow sparks or open flames near the filler neck. Never smoke while refueling. Fuel vapor is extremely hazardous under certain conditions. Care should be taken to avoid inhaling excess fumes.

 **WARNING:** The flow of fuel through a fuel pump nozzle can produce static electricity, which can cause a fire if fuel is pumped into an ungrounded fuel container.

### Refueling

 **WARNING:** Fuel vapor burns violently and a fuel fire can cause severe injuries. To help avoid injuries to you and others:

- Read and follow all the instructions on the pump island;
- Turn off your engine when you are refueling;
- Do not smoke if you are near fuel or refueling your vehicle;
- Keep sparks, flames and smoking materials away from fuel;
- Stay outside your vehicle and do not leave the fuel pump unattended when refueling your vehicle — this is against the law in some places;
- Keep children away from the fuel pump; never let children pump fuel.
- Do not use personal electronic devices while refueling.

Use the following guidelines to avoid electrostatic charge build-up when filling an ungrounded fuel container:

- Place approved fuel container on the ground.
- DO NOT fill a fuel container while it is in the vehicle (including the cargo area).
- Keep the fuel pump nozzle in contact with the fuel container while filling.
- DO NOT use a device that would hold the fuel pump handle in the fill position.



## Maintenance and Specifications

### Easy Fuel™ “no cap” fuel system

Your fuel tank is equipped with an Easy Fuel™ “no cap” fuel filler system. This allows you to simply open the fuel filler door and insert the fuel filler nozzle into the fuel system. The Easy Fuel™ system is self-sealing and protected against dust, dirt, water and snow/ice.

When fueling your vehicle:

1. Turn the engine off.
2. Open the fuel filler door.
3. Slowly insert the fuel filler nozzle fully into the fuel system, and leave the nozzle fully inserted until you are done pumping. Pump fuel as normal.
4. After you are done pumping fuel, slowly remove the fuel filler nozzle—allow about five seconds after pumping fuel before removing the fuel filler nozzle. This allows residual fuel to drain back into the fuel tank and not spill onto the vehicle.

**Note:** A fuel spillage concern may occur if overfilling the fuel tank. Do not overfill the tank to the point that the fuel is able to bypass the fuel filler nozzle. The overfilled fuel may run down the drain located within the fuel filler housing and to the ground.

If the Check Fuel Fill Inlet lamp or Check Fuel Fill Inlet message comes on, the fuel fill inlet may not have properly closed. The inlet may have stuck open or debris may be preventing the inlet from fully closing. At the next opportunity, safely pull off the road, turn off the engine, open the fuel filler door and remove any visible debris from the fuel fill opening. Insert either the fuel fill nozzle or the fuel fill funnel (see *Refilling with a portable fuel container* for funnel location) provided with the vehicle several times to dislodge any debris and/or allow the inlet to close properly. If this action corrects the problem, the Check Fuel Fill Inlet lamp or Check Fuel Fill Inlet message may not reset immediately. It may take several driving cycles for the Check Fuel Fill Inlet lamp or Check Fuel Fill Inlet message to turn off. A driving cycle consists of an engine start-up (after four or more hours with the engine off) followed by city/highway driving. Continuing to drive with the Check Fuel Fill Inlet lamp or Check Fuel Fill Inlet message on may cause the Service Engine Soon lamp to turn on as well.



**WARNING:** The fuel system may be under pressure. If you hear a hissing sound near the fuel filler door (Easy Fuel™ “no cap” fuel system), do not refuel until the sound stops. Otherwise, fuel may spray out, which could cause serious personal injury.

## Maintenance and Specifications

### ***Flex fuel vehicle (FFV) fuel fill inlet***

Flex fuel vehicles have a yellow bezel placed over the fuel fill inlet.

### **Choosing the right fuel**

Use only UNLEADED FUEL and FUEL ETHANOL (Ed75–Ed85).

The use of leaded fuel is prohibited by law and could damage your vehicle.

Your vehicle was not designed to use fuel or fuel additives with metallic compounds, including manganese-based additives.

**Note:** Use of any fuel other than those recommended may cause powertrain damage, a loss of vehicle performance, and repairs may not be covered under warranty.

### **Octane recommendations**

Your vehicle is designed to use “Regular” unleaded gasoline with a pump (R+M)/2 octane rating of 87. Some stations offer fuels posted as “Regular” with an octane rating below 87, particularly in high altitude areas. Fuels with octane levels below 87 are not recommended.

Do not be concerned if your engine sometimes knocks lightly. However, if it knocks heavily under most driving conditions while you are using fuel with the recommended

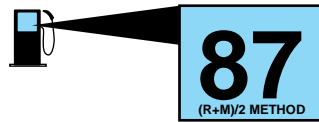

octane rating, see your authorized dealer to prevent any engine damage.

### ***FFV engines***

Your vehicle is designed to use Fuel Ethanol (Ed75–Ed85), “Regular” unleaded gasoline or any mixture of the two fuels.

**Use of other fuels such as Fuel Methanol may cause powertrain damage, a loss of vehicle performance, and your warranty may be invalidated.**

## Maintenance and Specifications

It is best not to alternate repeatedly between gasoline and E85. If you do switch fuels, it is recommended that you add as much fuel as possible—at least half a tank. Do not add less than five gallons (18.9L) when refueling. You should drive the vehicle immediately after refueling for at least 5 miles (8 km) to allow the vehicle to adapt to the change in ethanol concentration.

If you exclusively use E85 fuel, it is recommended to fill the fuel tank with regular unleaded gasoline at each scheduled oil change.

### Fuel quality

#### *Unleaded gasoline engines*

If you experience starting, rough idle or hesitation driveability problems during a cold start, try a different brand of “Regular” unleaded gasoline. “Premium” unleaded gasoline is not recommended for vehicles designed to use “Regular” unleaded gasoline because it may cause these problems to become more pronounced. If the problems persist, see your authorized dealer.

#### *FFV engines*

If you experience starting, rough idle or hesitation driveability problems during a cold start, try a different brand of E85 fuel. If the driveability problems continue, fill the vehicle with regular unleaded gasoline and drive vehicle normally until gasoline is used. See your authorized dealer if the problem persists.

Do not add aftermarket fuel additive products to your fuel tank. It should not be necessary to add any aftermarket products to your fuel tank if you continue to use high quality fuel of the recommended octane rating. These products have not been approved for your engine and could cause damage to the fuel system. Repairs to correct the effects of using an aftermarket product in your fuel may not be covered by your warranty.

Many of the world’s automakers approved the World-Wide Fuel Charter that recommends gasoline specifications to provide improved performance and emission control system protection for your vehicle. Gasolines that meet the World-Wide Fuel Charter should be used when available. Ask your fuel supplier about gasolines that meet the World-Wide Fuel Charter.

## Maintenance and Specifications

### Cleaner air

Ford endorses the use of reformulated “cleaner-burning” gasolines to improve air quality, per the recommendations in the *Choosing the right fuel* section.

### Running out of fuel

Avoid running out of fuel because this situation may have an adverse effect on powertrain components.

If you have run out of fuel:

- You may need to cycle the ignition from off to on several times after refueling to allow the fuel system to pump the fuel from the tank to the engine. On restarting, cranking time will take a few seconds longer than normal.
- Normally, adding 1 gallon (3.8L) of fuel is enough to restart the engine. If the vehicle is out of fuel and on a steep grade, more than 1 gallon (3.8L) may be required.
- The service engine soon  indicator may come on. For more information on the service engine soon indicator, refer to *Warning lights and chimes* in the *Instrument Cluster* chapter.

### Refilling with a portable fuel container

With the Easy Fuel™ “no cap” fuel system, use the following directions when filling from a portable fuel container:



**WARNING:** Do not insert the nozzle of portable fuel containers or aftermarket funnels into the Easy Fuel™ system. This could damage the fuel system and its seal, and may cause fuel to run onto the ground instead of filling the tank, which could result in serious personal injury.



**WARNING:** Do not try to pry open or push open the Easy Fuel™ system with foreign objects. This could damage the fuel system and its seal and cause injury to you or others.

When filling the vehicle’s fuel tank from a portable fuel container, use the included funnel.

## Maintenance and Specifications

1. Locate the white plastic funnel. It is attached to the underside of the spare tire cover or is included with the tire changing tools.

2. Slowly insert the funnel into the Easy Fuel™ system.

3. Fill the vehicle with fuel from the portable fuel container.

4. When done, clean the funnel or properly dispose of it. Extra funnels can be purchased from your authorized dealer if you choose to dispose of the funnel. **Do not** use aftermarket funnels; they will not work with the Easy Fuel™ system and can damage it. The included funnel has been specially designed to work safely with your vehicle.

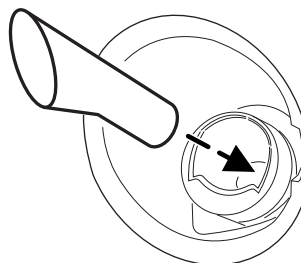

### ESSENTIALS OF GOOD FUEL ECONOMY

#### Measuring techniques

Your best source of information about actual fuel economy is you, the driver. You must gather information as accurately and consistently as possible. Fuel expense, frequency of fill-ups or fuel gauge readings are NOT accurate as a measure of fuel economy. We do not recommend taking fuel economy measurements during the first 1,000 miles (1,600 km) of driving (engine break-in period). You will get a more accurate measurement after 2,000 miles–3,000 miles (3,000 km–5,000 km).

#### Filling the tank

The advertised fuel capacity of the fuel tank on your vehicle is equal to the rated refill capacity of the fuel tank as listed in the *Maintenance product specifications and capacities* section of this chapter.

The advertised capacity is the amount of the indicated capacity and the empty reserve combined. Indicated capacity is the difference in the amount of fuel in a full tank and a tank when the fuel gauge indicates empty. Empty reserve is the small amount of fuel remaining in the fuel tank after the fuel gauge indicates empty.

**The amount of usable fuel in the empty reserve varies and should not be relied upon to increase driving range. When refueling your vehicle after the fuel gauge indicates empty, you might not be able to refuel the full amount of the advertised capacity of the fuel tank due to the empty reserve still present in the tank.**

## Maintenance and Specifications

For consistent results when filling the fuel tank:

- Turn the engine/ignition switch to the off position prior to refueling, an error in the reading will result if the engine is left running.
- Use the same filling rate setting (low — medium — high) each time the tank is filled.
- Allow no more than two automatic click-offs when filling.
- Always use fuel with the recommended octane rating.
- Use a known quality gasoline, preferably a national brand.
- Have the vehicle loading and distribution the same every time.

Your results will be most accurate if your filling method is consistent.

### Calculating fuel economy

1. Fill the fuel tank completely and record the initial odometer reading (in miles or kilometers).
2. Each time you fill the tank, record the amount of fuel added (in gallons or liters).
3. After at least three to five tank fill-ups, fill the fuel tank and record the current odometer reading.
4. Subtract your initial odometer reading from the current odometer reading.
5. Follow one of the simple calculations in order to determine fuel economy:

Calculation 1: **Divide total miles traveled by total gallons used.**

Calculation 2: **Multiply liters used by 100, then divide by total kilometers traveled.**

Keep a record for at least one month and record the type of driving (city or highway). This will provide an accurate estimate of the vehicle's fuel economy under current driving conditions. Additionally, keeping records during summer and winter will show how temperature impacts fuel economy. In general, lower temperatures give lower fuel economy.

### Driving style — good driving and fuel economy habits

Give consideration to the lists that follow and you may be able to change a number of variables and improve your fuel economy.

## Maintenance and Specifications

### **Habits**

- Smooth, moderate operation can yield up to 10% savings in fuel.
- Steady speeds without stopping will usually give the best fuel economy.
- Idling for long periods of time (greater than one minute) may waste fuel.
- Anticipate stopping; slowing down may eliminate the need to stop.
- Sudden or hard accelerations may reduce fuel economy.
- Slow down gradually.
- Driving at reasonable speeds (traveling at 55 mph [88 km/h] uses 15% less fuel than traveling at 65 mph [105 km/h]).
- Revving the engine before turning it off may reduce fuel economy.
- Using the air conditioner or defroster may reduce fuel economy.
- You may want to turn off the speed control in hilly terrain if unnecessary shifting between the top gears occurs. Unnecessary shifting of this type could result in reduced fuel economy.
- Warming up a vehicle on cold mornings is not required and may reduce fuel economy.
- Resting your foot on the brake pedal while driving may reduce fuel economy.
- Combine errands and minimize stop-and-go driving.

### **Maintenance**

- Keep tires properly inflated and use only recommended size.
- Operating a vehicle with the wheels out of alignment will reduce fuel economy.
- Use recommended engine oil. Refer to *Maintenance product specifications and capacities* in this chapter.
- Perform all regularly scheduled maintenance items. Follow the recommended maintenance schedule and owner maintenance checks found in *scheduled maintenance information*.

### **Conditions**

- Heavily loading a vehicle or towing a trailer may reduce fuel economy at any speed.
- Carrying unnecessary weight may reduce fuel economy (as much as 1 mpg [0.4 km/L] is lost for every 400 lb [180 kg] of weight carried).

## Maintenance and Specifications

- Adding certain accessories to your vehicle (for example; bug deflectors, rollbars/light bars, running boards, ski/luggage racks) may reduce fuel economy.
- Using fuel blended with alcohol may lower fuel economy.
- Fuel economy may decrease with lower temperatures during the first 8–10 miles (12–16 km) of driving.
- Driving on flat terrain offers improved fuel economy as compared to driving on hilly terrain.
- Transmissions give their best fuel economy when operated in the top cruise gear and with steady pressure on the gas pedal.
- Four-wheel drive operation (if equipped) is less fuel efficient than two-wheel drive operation.
- Close windows for high speed driving.

### EMISSION CONTROL SYSTEM

Your vehicle is equipped with various emission control components and a catalytic converter which will enable your vehicle to comply with applicable exhaust emission standards. To make sure that the catalytic converter and other emission control components continue to work properly:

- Use only the specified fuel listed.
- Avoid running out of fuel.
- Do not turn off the ignition while your vehicle is moving, especially at high speeds.
- Have the items listed in *scheduled maintenance information* performed according to the specified schedule.

The scheduled maintenance items listed in *scheduled maintenance information* are essential to the life and performance of your vehicle and to its emissions system.

If other than Ford, Motorcraft® or Ford-authorized parts are used for maintenance replacements or for service of components affecting emission control, such non-Ford parts should be equivalent to genuine Ford Motor Company parts in performance and durability.



**WARNING:** Do not park, idle, or drive your vehicle in dry grass or other dry ground cover. The emission system heats up the engine compartment and exhaust system, which can start a fire.



## Maintenance and Specifications

Illumination of the service engine soon  indicator, charging system warning light or the temperature warning light, fluid leaks, strange odors, smoke or loss of engine power could indicate that the emission control system is not working properly.

An improperly operating or damaged exhaust system may allow exhaust to enter the vehicle. Have a damaged or improperly operating exhaust system inspected and repaired immediately.





**WARNING:** Exhaust leaks may result in entry of harmful and potentially lethal fumes into the passenger compartment.

Do not make any unauthorized changes to your vehicle or engine. By law, vehicle owners and anyone who manufactures, repairs, services, sells, leases, trades vehicles, or supervises a fleet of vehicles are not permitted to intentionally remove an emission control device or prevent it from working. Information about your vehicle's emission system is on the Vehicle Emission Control Information Decal located on or near the engine. This decal also lists engine displacement.

Please consult your *Warranty Guide* for complete emission warranty information.

### On-board diagnostics (OBD-II)



Your vehicle is equipped with a computer that monitors the engine's emission control system. This system is commonly known as the on-board diagnostics system (OBD-II). The OBD-II system protects the environment by ensuring that your vehicle continues to meet government emission standards. The OBD-II system also assists your authorized dealer in properly servicing your vehicle. When the service engine soon  indicator illuminates, the OBD-II system has detected a malfunction. Temporary malfunctions may cause the service engine soon  indicator to illuminate. Examples are:

1. The vehicle has run out of fuel—the engine may misfire or run poorly.
2. Poor fuel quality or water in the fuel—the engine may misfire or run poorly.
3. The fuel fill inlet may not have been properly closed. See *Easy Fuel™* “no cap” fuel system in this chapter.
4. Driving through deep water—the electrical system may be wet.

These temporary malfunctions can be corrected by filling the fuel tank with good quality fuel, properly closing the fuel fill inlet or letting the

## Maintenance and Specifications



electrical system dry out. After three driving cycles without these or any other temporary malfunctions present, the service engine soon  indicator should stay off the next time the engine is started. A driving cycle consists of a cold engine startup followed by mixed city/highway driving. No additional vehicle service is required.

If the service engine soon  indicator remains on, have your vehicle serviced at the first available opportunity. Although some malfunctions detected by the OBD-II may not have symptoms that are apparent, continued driving with the service engine soon  indicator on can result in increased emissions, lower fuel economy, reduced engine and transmission smoothness, and lead to more costly repairs.

### Readiness for Inspection/Maintenance (I/M) testing

Some state/provincial and local governments may have Inspection/Maintenance (I/M) programs to inspect the emission control equipment on your vehicle. Failure to pass this inspection could prevent you from getting a vehicle registration. Your vehicle may not pass the I/M test if the service engine soon  indicator is on or not working properly (bulb is burned out), or if the OBD-II system has determined that some of the emission control systems have not been properly checked. In this case, the vehicle is considered not ready for I/M testing.

If the service engine soon  indicator is on or the bulb does not work, the vehicle may need to be serviced. Refer to *On-board diagnostics (OBD-II)* in this chapter.

If the vehicle's engine or transmission has just been serviced, or the battery has recently run down or been replaced, the OBD-II system may indicate that the vehicle is not ready for I/M testing. To determine if the vehicle is ready for I/M testing, turn the ignition key to the on position for 15 seconds without cranking the engine. If the service engine soon  indicator blinks eight times, it means that the vehicle is not ready for I/M testing; if the service engine soon  indicator stays on solid, it means that the vehicle is ready for I/M testing.

The OBD-II system is designed to check the emission control system during normal driving. A complete check may take several days. If the vehicle is not ready for I/M testing, the following driving cycle consisting of mixed city and highway driving may be performed:

15 minutes of steady driving on an expressway/highway followed by 20 minutes of stop-and-go driving with at least four 30-second idle periods.

## Maintenance and Specifications

Allow the vehicle to sit for at least eight hours without starting the engine. Then, start the engine and complete the above driving cycle. The engine must warm up to its normal operating temperature. Once started, do not turn off the engine until the above driving cycle is complete. If the vehicle is still not ready for I/M testing, the above driving cycle will have to be repeated.

### POWER STEERING FLUID

Check the power steering fluid. Refer to *scheduled maintenance information*.

1. Start the engine and let it run until it reaches normal operating temperature (the engine coolant temperature gauge indicator will be near the center of the normal area between H and C).
2. While the engine idles, turn the steering wheel left and right several times.
3. Turn the engine off.

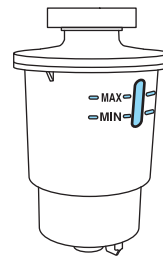

4. Check the fluid level in the reservoir. It should be between the MIN and MAX lines. Do not add fluid if the level is in this range.
5. If the fluid is low, add fluid in small amounts, continuously checking the level until it reaches the range between the MIN and MAX lines. Be sure to put the cap back on the reservoir. Refer to *Maintenance product specifications and capacities* in this chapter for the proper fluid type.

### BRAKE FLUID

The fluid level will drop slowly as the brakes wear, and will rise when the brake components are replaced. Fluid levels between the MIN and MAX lines are within the normal operating range; there is no need to add fluid. If the fluid levels are outside of the normal operating range, the performance of the system could be compromised; seek service from your authorized dealer immediately.

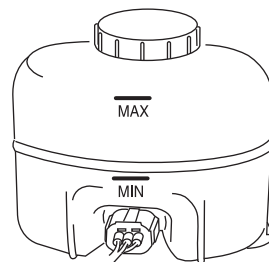

## Maintenance and Specifications

### TRANSMISSION FLUID

#### Checking automatic transmission fluid

The automatic transmission does not have a transmission fluid dipstick.

Refer to your *scheduled maintenance information* for scheduled intervals for fluid checks and changes. Your transmission does not consume fluid. However, the fluid level should be checked if the transmission is not working properly, (i.e., if the transmission slips or shifts slowly) or if you notice some sign of fluid leakage.

**Transmission fluid should be checked by an authorized dealer. If required, fluid should be added by an authorized dealer.**

Do not use supplemental transmission fluid additives, treatments or cleaning agents. The use of these materials may affect transmission operation and result in damage to internal transmission components.

### AIR FILTER

Refer to *scheduled maintenance information* for the appropriate intervals for changing the air filter element.

When changing the air filter element, use only the air filter element listed. Refer to *Motorcraft® part numbers* in this chapter.



**WARNING:** To reduce the risk of vehicle damage and/or personal burn injuries do not start your engine with the air cleaner removed and do not remove it while the engine is running.

#### Changing the air filter element

1. Locate the mass air flow sensor electrical connector on the air outlet tube. This connector will need to be unplugged.

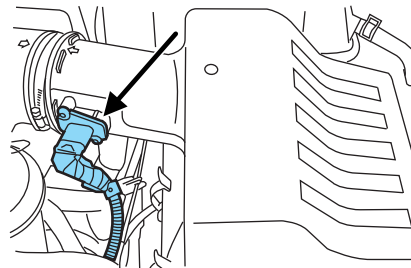

## Maintenance and Specifications

2. Unlock the locking clip on the connector (connector shown from below for clarity), then squeeze and pull the connector off of the air outlet tube.

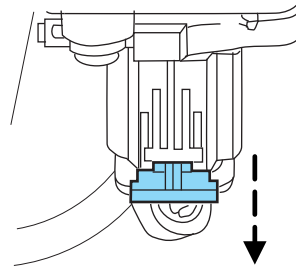

3. Clean the area around the air tube to air cover connection to prevent debris from entering the system and then loosen the bolt on the air tube clamp so the clamp is no longer snug to the air tube. It is not necessary to completely remove the clamp.

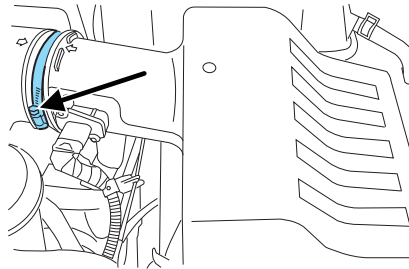

4. Pull the air tube off from the air cleaner housing.

5. Release the three clamps that secure the cover to the air filter housing. Push the air filter cover toward the center of the vehicle and up slightly to release it.

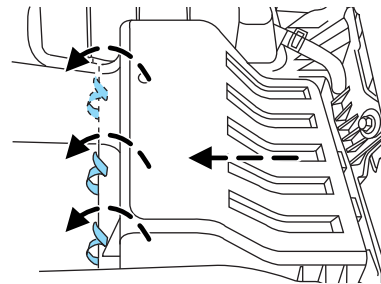

## Maintenance and Specifications

6. Remove the air filter element from the air filter housing.
7. Install a new air filter element.

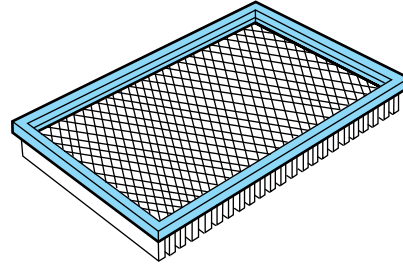

8. Replace the air filter housing cover and secure the clamps. Be careful not to crimp the filter element edges between the air filter housing and cover and ensure that the tabs on the edge are properly aligned into the slots.
9. Slip the air tube onto the air filter housing and tighten the air-tube clamp bolt snugly, but do not overtighten it.

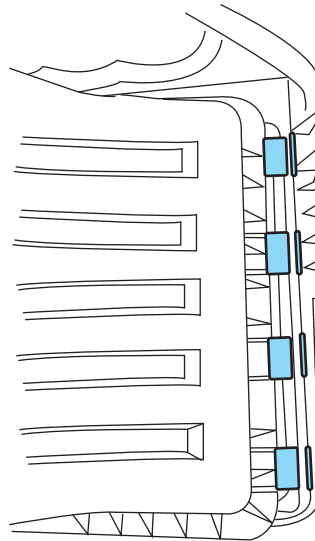

10. Reconnect the mass air flow sensor electrical connector to the outlet tube. Make sure the locking tab on the connector is in the "locked" position (connector shown from below for clarity).

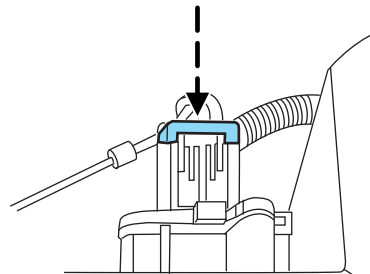

## Maintenance and Specifications

**Note:** Failure to use the correct air filter element may result in severe engine damage. The customer warranty may be void for any damage to the engine if the correct air filter element is not used.

### VEHICLE STORAGE

If you plan on storing your vehicle for an extended period of time (30 days or more), refer to the following maintenance recommendations to ensure your vehicle stays in good operating condition.

All motor vehicles and their components were engineered and tested for reliable, regular driving. Long term storage under various conditions may lead to component degradation or failure unless specific precautions are taken to preserve the components.

#### *General*

- Store all vehicles in a dry, ventilated place.
- Protect from sunlight, if possible.
- If vehicles are stored outside, they require regular maintenance to protect against rust and damage.

#### *Body*

- Wash vehicle thoroughly to remove dirt, grease, oil, tar or mud from exterior surfaces, rear-wheel housing and underside of front fenders. See the *Cleaning* chapter for more information.
- Periodically wash vehicles stored in exposed locations.
- Touch-up raw or primed metal to prevent rust.
- Cover chrome and stainless steel parts with a thick coat of auto wax to prevent discoloration. Re-wax as necessary when the vehicle is washed. See the *Cleaning* chapter for more information.
- Lubricate all hood, door and trunk lid hinges, and latches with a light grade oil. See the *Cleaning* chapter for more information.
- Cover interior trim to prevent fading.
- Keep all rubber parts free from oil and solvents.

#### *Engine*

- The engine oil and filter should be changed prior to storage, as used engine oil contain contaminants that may cause engine damage.
- Start the engine every 15 days. Run at fast idle until it reaches normal operating temperature.
- With your foot on the brake, shift through all the gears while the engine is running.

## Maintenance and Specifications

### *Fuel system*

- Fill the fuel tank with high-quality fuel until the first automatic shutoff of the fuel pump nozzle.

**Note:** During extended periods of vehicle storage (30 days or more), fuel may deteriorate due to oxidation. Add Motorcraft® Gas Stabilizer or equivalent meeting Ford material specification ESE-M99C112-A to the vehicle fuel system whenever actual or expected storage periods exceed 30 days. Follow the instructions on the additive label. The vehicle should then be operated at idle speed to circulate the additive throughout the fuel system.

### *Cooling system*

- Protect against freezing temperatures.
- When removing vehicle from storage, check coolant fluid level. Confirm there are no cooling system leaks, and fluid is at the recommended level.

### *Battery*

- Check and recharge as necessary. Keep connections clean.
- If storing your vehicle for more than 30 days without recharging the battery, it may be advisable to disconnect the battery cables to ensure battery charge is maintained for quick starting.

**Note:** If battery cables are disconnected, it will be necessary to reset memory features.

### *Brakes*

- Make sure brakes and parking brake are fully released.

### *Tires*

- Maintain recommended air pressure.

### *Miscellaneous*

- Make sure all linkages, cables, levers and pins under vehicle are covered with grease to prevent rust.
- Move vehicles at least 25 feet (8 m) every 15 days to lubricate working parts and prevent corrosion.



## Maintenance and Specifications

### Removing vehicle from storage

When your vehicle is ready to come out of storage, do the following:

- Wash your vehicle to remove any dirt or grease film build-up on window surfaces.
- Check windshield wipers for any deterioration.
- Check under the hood for any foreign material that may have collected during storage (mice/squirrel nests).
- Check the exhaust for any foreign material that may have collected during storage.
- Check tire pressures and set tire inflation per the Tire Label.
- Check brake pedal operation. Drive the vehicle 15 ft (4.5 meters) back and forth to remove rust build up.
- Check fluid levels (including coolant, oil and gas) to make sure there are no leaks, and fluids are at recommended levels.
- If the battery was removed, clean the battery cable ends and inspect.

If you have any concerns or issues, contact your authorized dealer.

### MOTORCRAFT PART NUMBERS

Component	5.4L V8 engine
Air filter element	FA-1883
Battery	BXT-65-650 or BXT-65-750 (if equipped)
Oil filter	FL-820-S
Spark plugs	<sup>1</sup>

<sup>1</sup>For spark plug replacement, see your authorized dealer. Refer to *scheduled maintenance information* for the appropriate intervals for changing the spark plugs.

**Replace the spark plugs with ones that meet Ford material and design specifications for your vehicle, such as Motorcraft® or equivalent replacement parts. The customer warranty may be void for any damage to the engine if such spark plugs are not used.**

## Maintenance and Specifications

### MAINTENANCE PRODUCT SPECIFICATIONS AND CAPACITIES

Item	Capacity	Ford part name	Ford part number / Ford specification
Brake fluid	Between MIN and MAX on reservoir	Motorcraft® High Performance DOT 3 Motor Vehicle Brake Fluid	PM-1-C / WSS-M6C62-A or WSS-M6C65-A1
Hinges, latches, striker plates and rotors, seat tracks, fuel filler door hinge and spring	—	Multi-Purpose Grease (Lithium grease)	XG-4 or XL-5 or equivalent / ESB-M1C93-B
Lock cylinders	—	Motorcraft® Penetrating and Lock Lubricant	XL-1 / None
Engine coolant (Base radiator without aux rear heat)	16.4 quarts (15.5L)	<ul style="list-style-type: none"> <li>Motorcraft® Specialty Orange Engine Coolant with Bittering Agent (US)</li> <li>Motorcraft® Specialty Orange Engine Coolant (Canada)<sup>1</sup></li> </ul>	<ul style="list-style-type: none"> <li>VC-3-B (US)</li> <li>CVC-3-B (Canada) /</li> <li>WSS-M97B44-D</li> </ul>
Engine coolant (Heavy-duty trailer tow radiator without aux rear heat)	16.9 quarts (16.0L)		
Engine coolant (Base radiator with aux rear heat)	19.0 quarts (18.0L)		
Engine coolant (Heavy-duty trailer tow radiator with aux rear heat)	19.5 quarts (18.5L)		

## Maintenance and Specifications

Item	Capacity	Ford part name	Ford part number / Ford specification
Engine oil	7.0 quarts (6.6L)	<ul style="list-style-type: none"> <li>• Motorcraft® SAE 5W-20 Premium Synthetic Blend Motor Oil</li> <li>• Motorcraft® SAE 5W-20 Full Synthetic Motor Oil (US)</li> <li>• Motorcraft® SAE 5W-20 Super Premium Motor Oil</li> <li>• Motorcraft® SAE 5W20 Synthetic Motor Oil (Canada)<sup>2</sup></li> </ul>	<ul style="list-style-type: none"> <li>• XO-5W20-QSP (US)</li> <li>• XO-5W20-QFS (US)</li> <li>• CXO-5W20-LSP12 (Canada)</li> <li>• CXO-5W20-LFS12 (Canada) / WSS-M2C930-A and API Certification Mark</li> </ul>
Automatic transmission fluid (6R80)	13.1 quarts (12.4L) <sup>3</sup>	Motorcraft® MERCEN® LV ATF <sup>4</sup>	XT-10-QLV / MERCEN® LV
Power steering fluid	Fill between MIN and MAX lines on reservoir	Motorcraft® MERCEN® V ATF	XT-5-QM / MERCEN® V
Front axle fluid (4X4)	3.5 pints (1.7L)	Motorcraft® SAE 80W-90 Premium Rear Axle Lube	XY-80W90-QL / WSP-M2C197-A
Rear axle fluid	4.5 pints (2.1 L)		
–Conventional differential (9.75 inch axle)	4.25 pints (2.01L) <sup>5</sup>	Motorcraft® SAE 75W-140 Synthetic Rear Axle Lube <sup>6</sup>	XY-75W140-QL / WSL-M2C192-A
Rear axle fluid–Limited-slip differential (9.75 inch axle)			

<https://www.MyCarManual.com>

355

## Maintenance and Specifications

Item	Capacity	Ford part name	Ford part number / Ford specification
Transfer case fluid (4X4)	1.6-1.8 quarts (1.5-1.7L)	Motorcraft® Transfer Case Fluid	XL-12 / ESP-M2C166-H
Windshield washer fluid	Fill as required	Motorcraft® Premium Windshield Washer Concentrate (US) Premium Quality Windshield Washer Fluid (Canada)	ZC-32-A (US) CXC-37-(A, B, D, and F) (Canada) / WSB-M8B16-A2/- -
Fuel tank (standard)	28.0 gallons (106.0L)	—	—
Fuel tank (Expedition EL – U.S. only)	33.5 gallons (126.8L)		

## Maintenance and Specifications

Item	Capacity	Ford part name	Ford part number / Ford specification
Fuel tank (Expedition Max – Canada only)	33.5 gallons (126.8L)		

<sup>1</sup>Add the coolant type originally equipped in your vehicle. Check the coolant reservoir bottle labeling for the correct fluid type to use.

<sup>2</sup>Use of synthetic or synthetic blend motor oil is not mandatory. Engine oil need only meet the requirements of Ford specification WSS-M2C930-A and the API Certification mark.

<sup>3</sup>Indicates only approximate dry-fill capacity. Some applications may vary based on cooler size and if equipped with an in-tank cooler.

<sup>4</sup>Automatic transmissions that require MERCON® LV should only use MERCON® LV fluid. Refer to *scheduled maintenance information* to determine the correct service interval. Use of any fluid other than the recommended fluid may cause transmission damage.

<sup>5</sup>Add 4 oz. (118 ml) of Additive Friction Modifier XL-3 or equivalent for complete refill of Ford limited slip rear axles.

<sup>6</sup>Your vehicle's rear axle is filled with a synthetic rear axle lubricant and is considered lubricated for life. These lubricants are not to be checked or changed unless a leak is suspected, service is required or the axle has been submerged in water. The axle lubricant should be changed any time the axle has been submerged in water.

## Maintenance and Specifications

### ENGINE DATA

Engine	5.4L V8 Engine
Cubic inches	330
Fuel	87 octane or (E-85)
Firing order	1-3-7-2-6-5-4-8
Ignition system	Coil on plug
Spark plug gap	0.039–0.043 inch (1.05 +/- 0.05mm)
Compression ratio	9.8:1

## Maintenance and Specifications

### Engine drivebelt routing

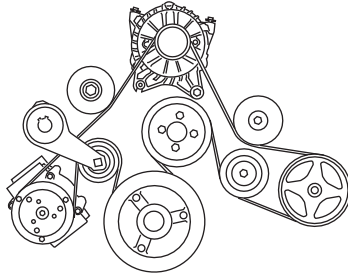

### IDENTIFYING YOUR VEHICLE

#### Safety Compliance Certification Label

The National Highway Traffic Safety Administration Regulations require that a Safety Compliance Certification Label be affixed to a vehicle and prescribe where the Safety Compliance Certification Label may be located. The Safety Compliance Certification Label is located on the structure (B-Pillar) by the trailing edge of the driver's door or the edge of the driver's door.

<b>MFD. BY FORD MOTOR CO.</b>			
DATE: XX/XX	GVWR: XXXXXLB/ XXXXXKG		
FRONT GAWR: XXXXL	REAR GAWR: XXXXLB		
XXXXKG	WITH XXXXKG	WITH	
XXXX/XXXXXXXX	TIRES XXXX/XXXXXXXX	TIRES	
XXXX.XX	RIMS XXXX.XX	RIMS	
AT XXX kPa/XX	PSI COLD AT XXX kPa/XX	PSI COLD	
THIS VEHICLE CONFORMS TO ALL APPLICABLE FEDERAL MOTOR VEHICLE SAFETY AND THEFT PREVENTION STANDARDS IN EFFECT ON THE DATE OF MANUFACTURE SHOWN ABOVE.			
VIN: XXXXXXXXXXXXXXXXX		XXXXX	
TYPE: XXX		XXXXX	
			
EXT PNT: XX	RC: XX	DSO:	
WB <sup>1</sup> BRK <sup>1</sup> INT TR <sup>1</sup> TP/PS <sup>1</sup> R <sup>1</sup>	AXLE <sup>1</sup> TR SPR <sup>1</sup>	XXXXX	
XXX X XX	X XX X XX	XXX	
XXXXXXXXXXXXX XXX XXXX-XXXXXXXX-XX			

## Maintenance and Specifications

### Vehicle identification number (VIN)

The vehicle identification number is located on the driver side instrument panel.

Please note that in the graphic, XXXX is representative of your vehicle identification number.

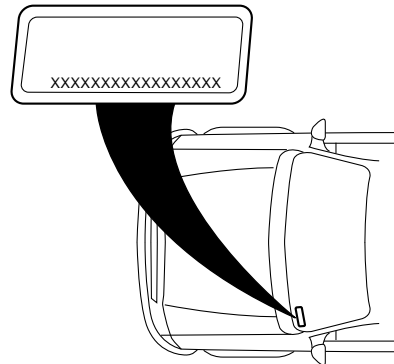

The Vehicle Identification Number (VIN) contains the following information:

1. World manufacturer identifier
2. Brake system / Gross Vehicle Weight Rating (GVWR) / Restraint Devices and their location
3. Make, vehicle line, series, body type
4. Engine type
5. Check digit
6. Model year
7. Assembly plant
8. Production sequence number

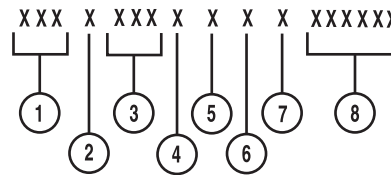



## Maintenance and Specifications

### TRANSMISSION CODE DESIGNATIONS

You can find a transmission code on the Safety Compliance Certification Label. The following table tells you which transmission each code represents.

MFD. BY FORD MOTOR CO.									
DATE: XXXX	GVWR: XXXXXLB/ XXXXXKG								
FRONT GAWR: XXXXL	WITH XXXXXKG		REAR GAWR: XXXXLB		WITH XXXXXKG				
XXXXXX/XXXXXX	TIRES: XXXXX/XXXXXX		XXXXXX/XXXXXX		TIRES: XXXXX/XXXXXX				
XXXX.XX	RIMS: XXXX.XX		XXXX.XX		RIMS: XXXX.XX				
AT XXX kPa/XX	PSI COLD		AT XXX kPa/XX		PSI COLD				
THIS VEHICLE CONFORMS TO ALL APPLICABLE FEDERAL MOTOR VEHICLE SAFETY AND THEFT PREVENTION STANDARDS IN EFFECT ON THE DATE OF MANUFACTURE SHOWN ABOVE.									
VIN: XXXXXXXXXXXXXXXXX	XXXXXX				XXXXXX				
TYPE: XXX									
									
EXT PNT: XX	RC: XX		DSD: XXXXX						
WB <sup>1</sup> BRK <sup>1</sup>	INT TR	TP/PS	R	AXLE	TR	SPR	XXXXX		
XXX X	XX	X	XX	X	XX	XX	XXX		
XXXXXXXXXXXXXX XX XXXX-XXXXXX-XX									

Description	Code
Six-speed automatic (6R80 )	6

## Accessories

### FORD CUSTOM ACCESSORIES FOR YOUR VEHICLE

A wide selection of Ford Custom Accessories are available for your vehicle through your local Ford or Ford of Canada dealer. These quality accessories have been specifically engineered to fulfill your automotive needs; they are custom designed to complement the style and aerodynamic appearance of your vehicle. In addition, each accessory is made from high quality materials and meets or exceeds Ford's rigorous engineering and safety specifications. Ford Motor Company will repair or replace any properly dealer-installed Ford Custom Accessories found to be defective in factory-supplied materials or workmanship during the warranty period, as well as any component damaged by the defective accessories. The accessories will be warranted for whichever provides you the greatest benefit:

- 12 months or 12,000 miles (20,000 km) (whichever occurs first), or
- the remainder of your new vehicle limited warranty.

Contact your dealer for details and a copy of the warranty.

The following is a list of several Ford Custom Accessories. Not all accessories are available for all models. For a complete listing of the accessories that are available for your vehicle, please contact your dealer or visit our online store at: [www.fordaccessories.com](http://www.fordaccessories.com) (U.S. only).

#### Exterior style

- Bug shields
- Deflectors
- Splash guards
- Wheels
- Chrome exhaust tips
- Custom graphics\*

#### Interior style

- Ambient lighting
- Backlit door sill plates
- Electrochromatic compass/temperature interior mirrors
- Floor mats
- Custom seat covers\*

#### Lifestyle

- Rear seat entertainment\*
- Navigation\*
- Racks and carriers\*
- Cargo organization and management
- Roof crossbars
- SUV camping tent\*
- Subwoofer\*

## Accessories

### Peace of mind

- Remote start
- Vehicle tracking and recovery\*
- Protective seat covers\*
- Windshield wiper shaker\*
- Locking gas plug for capless fuel system
- Bumper and hitch mounted parking sensors\*
- Factory navigation system software upgrades\*
- Vehicle security systems
- Wheel locks
- Back up camera\*
- Back up alarm\*

\*Ford Licensed Accessories (FLA) are warranted by the accessory manufacturer's warranty. Ford Licensed Accessories are fully designed and developed by the accessory manufacturer and have not been designed or tested to Ford Motor Company engineering requirements. Contact your Ford dealer for details regarding the manufacturer's limited warranty and/or a copy of the FLA product limited warranty offered by the accessory manufacturer.

For maximum vehicle performance, keep the following information in mind when adding accessories or equipment to your vehicle:

- When adding accessories, equipment, passengers and luggage to your vehicle, do not exceed the total weight capacity of the vehicle or of the front or rear axle (GVWR or GAWR as indicated on the Safety Compliance Certification label). Consult your authorized dealer for specific weight information.
- The Federal Communications Commission (FCC) and Canadian Radio Telecommunications Commission (CRTC) regulate the use of mobile communications systems — such as two-way radios, telephones and theft alarms - that are equipped with radio transmitters. Any such equipment installed in your vehicle should comply with FCC or CRTC regulations and should be installed only by a qualified service technician.
- Mobile communications systems may harm the operation of your vehicle, particularly if they are not properly designed for automotive use.
- To avoid interference with other vehicle functions, such as anti-lock braking systems, amateur radio users who install radios and antennas onto their vehicle should not locate the Amateur Radio Antennas in the area of the driver's side hood.
- Electrical or electronic accessories or components that are added to the vehicle by the authorized dealer or the owner may adversely affect battery performance and durability.

## Ford Extended Service Plan

### FORD ESP EXTENDED SERVICE PLANS (U.S. ONLY)

More than 30 million Ford, Lincoln, and Mercury owners have discovered the powerful protection of Ford ESP. It is the only extended service plan backed by Ford Motor Company, and provides “peace of mind” protection beyond the New Vehicle Limited Warranty coverage.

#### ***Up to 500+ Covered Vehicle Components***

There are four, new-vehicle Extended Service Plans with different levels of coverage. Ask your dealer for details.

**PremiumCare** – Our most comprehensive coverage. With over 500 covered components, this plan is so complete that we generally only discuss what’s not covered!

**ExtraCare** – Covers 113 components, and includes many high-tech items.

**BaseCare** – Covers 84 components.

**PowertrainCare** – Covers 29 critical components.

**Ford ESP is honored by all Ford, Lincoln and Mercury Dealers in the U.S. and Canada** It’s the only extended service plan authorized and backed by Ford Motor Company. That means you get:

- Reliable, quality service anywhere you go.
- **Factory-trained technicians.**
- **Genuine Ford and Motorcraft® Parts.**

#### ***Rental car reimbursement***

**If your vehicle is kept overnight for covered repairs**, you are eligible for rental car coverage, including Bumper-to-Bumper warranty repairs, or manufacturer’s recalls.

#### ***Transferable coverage***

If you sell your vehicle before your Ford ESP coverage expires, you can transfer any remaining coverage to the new owner. Whenever you’re ready to sell your car, prospective buyers may feel better about taking a risk on your used vehicle. Ford ESP may add resale value!

Plus, **exclusive 24/7 roadside assistance**, including:

- Towing, flat-tire change and battery jump starts.
- Out-of-fuel and lock-out assistance.
- Travel expense reimbursement for lodging, meals and rental car.
- Destination assistance for taxi, shuttle, rental car coverage and emergency transportation.

## Ford Extended Service Plan

### ***Ford ESP Can Quickly Pay for Itself***

One service bill – the cost of parts and labor – can easily exceed the price of your Ford ESP Service Contract. With Ford ESP, you minimize your risk for unexpected repair bills and rising repair costs.

### ***Avoid the rising cost of properly maintaining your vehicle!***

Ford ESP also offers a Premium Maintenance Plan that covers items that **routinely wear out**.

The coverage is prepaid, so you never have to worry about affording your vehicle maintenance. It covers regular checkups, routine inspections, preventive care and replacement of items that require periodic attention for **normal “wear”**:

- **Wiper blades**
- **Spark plugs (except California)**
- **Clutch disc**
- **Brake pads and linings**
- **Shock absorbers**
- **Belts and hoses**

Contact your selling Ford, Lincoln, or Mercury dealership today so they can customize a Ford Extended Service Plan that fits your driving lifestyle and budget.

### ***Interest free finance options available***

Take advantage of our installment payment plan, just a 10% down payment will provide you with an affordable no interest, no-fee payment opportunity.

Ford Extended Service Plan



***Get Genuine Peace of Mind with Ford ESP!***

To learn more, complete the information below and mail this to:

**Ford ESP  
P.O. Box 8072  
Royal Oak, MI 48068-9933**

NAME (PLEASE PRINT) \_\_\_\_\_  
ADDRESS \_\_\_\_\_ APT.NO. \_\_\_\_\_  
CITY \_\_\_\_\_ STATE \_\_\_\_\_ ZIP \_\_\_\_\_  
E-MAIL: \_\_\_\_\_

## Ford Extended Service Plan

### **FORD ESP EXTENDED SERVICE PLANS (CANADA ONLY)**

You can get more protection for your vehicle by purchasing a Ford Extended Service Plan (ESP). Ford ESP is the only service contract backed by Ford Motor Company of Canada, Limited. Depending on the plan you purchase, Ford ESP provides benefits such as:

- Rental reimbursement
- Coverage for certain maintenance and wear items
- Protection against repair costs after your New Vehicle Limited Warranty Coverage expires
- Roadside Assistance benefits

There are several Ford ESP plans available in various time, distance and deductible combinations. Each plan is tailored to fit your own driving needs, including reimbursement for towing and rental.

When you purchase Ford ESP, you receive added peace-of-mind protection throughout Canada and the United States, provided by a network of participating Ford Motor Company dealers.

For more information, visit your local Ford of Canada dealer or [www.ford.ca](http://www.ford.ca) to find the Ford Extended Service Plan that is right for you.

**NOTE:** Repairs performed outside of Canada and the United States are not eligible for Ford ESP coverage. This information is subject to change.

## Scheduled Maintenance Guide

### GENERAL MAINTENANCE INFORMATION

#### Why maintain your vehicle?

This guide describes the scheduled maintenance required for your vehicle. Carefully following this schedule helps protect against major repair expenses resulting from neglect or inadequate maintenance and may also help to increase the value of your vehicle when you sell or trade it.

It is your responsibility to see that all scheduled maintenance is performed and that the materials used meet Ford engineering specifications. Failure to perform scheduled maintenance specific in this guide will invalidate warranty coverage on parts affected by the lack of maintenance. Be sure receipts for completed maintenance are kept with the vehicle and confirmation of the work performed is always recorded in this guide.

Your Ford or Lincoln Mercury dealer has factory-trained technicians who can perform the required maintenance using genuine Ford parts. They are committed to meeting your service needs and to assuring your continuing satisfaction.

#### Protecting your investment

Maintenance is an investment that will pay dividends in the form of improved reliability, durability and resale value. To ensure the proper performance of your vehicle and its emission control systems, it is imperative that scheduled maintenance be completed at the designated intervals.

Your vehicle is very sophisticated and built with multiple complex performance systems. Every manufacturer develops these systems using different specifications and performance features. That's why it's important to rely upon your Ford or Lincoln Mercury dealership to properly diagnose and repair your vehicle.

Ford Motor Company has recommended maintenance intervals for various parts and component systems based upon engineering testing. Ford Motor Company relies upon this testing to determine the most appropriate mileage for replacement of oils and fluids to protect your vehicle at the lowest overall cost to you and recommends against maintenance schedules that deviate from the scheduled maintenance information.

Ford strongly recommends the use of genuine Ford replacement parts. Parts other than Ford, Motorcraft® or Ford-authorized remanufactured parts that are used for maintenance replacement or for the service of components affecting emission control must be equivalent to genuine



## Scheduled Maintenance Guide

Ford Motor Company parts in performance and durability. It is the owner's responsibility to determine the equivalency of such parts. Please consult your *Warranty Guide* for complete warranty information.

Non-Ford approved chemicals or additives are not required for factory recommended maintenance. In fact, Ford Motor Company recommends against the use of such additive products unless specifically recommended by Ford for a particular application.

### ***Oil, fluids and flushing***

In many cases, fluid discoloration is a normal operating characteristic and, by itself, does not necessarily indicate a concern or that the fluid needs to be changed. However, discolored fluids that also show signs of overheating and/or foreign material contamination should be inspected immediately by a qualified expert such as the factory-trained technicians at your Ford or Lincoln Mercury Dealership. Your vehicle's oils and fluids should be changed at the specified intervals or in conjunction with a repair. Flushing is a viable way to change fluid for many vehicle sub-systems during scheduled maintenance. It is critical that systems are flushed only with new fluid that is the same as that required to fill and operate the system, or using a Ford-approved flushing chemical.

### **Genuine Ford parts and service**

When planning your maintenance services, consider your Ford and Lincoln Mercury dealership for all your vehicle's needs.

### **Get the most from your service and maintenance visits**

There are a lot of reasons why visiting your Ford or Lincoln Mercury dealership for all your service needs is a great way to help keep your vehicle running great.

### ***Convenience***

Many dealerships have extended evening and Saturday hours to make your service visit more convenient. How's that for quality service?

### ***Factory-trained technicians***

Ford and Lincoln Mercury service technicians participate in extensive factory-sponsored certification training to help them become experts on the operation of your vehicle. Ask your dealership about the training and certification their technicians have received.

## Scheduled Maintenance Guide

### **Genuine Ford and Motorcraft® replacement parts**

Ford and Lincoln Mercury dealerships stock Ford and Motorcraft® branded replacement parts. These parts meet or exceed Ford Motor Company's specifications, and we stand behind them. Parts installed at your Ford or Lincoln Mercury dealership carry a nationwide, 12 months, 12,000 mile (20,000 km) parts and labor limited warranty. Your dealer can give you details.

### **Value shopping for your vehicle's maintenance needs**

Your dealership recognizes the competitive landscape of maintenance and light repair automotive services. With factory-trained technicians, and one-stop service from routine maintenance like oil changes and tire rotations to repairs like brake service, check out the value your Ford and Lincoln Mercury dealers can offer.

## **WHICH MAINTENANCE SCHEDULE SHOULD YOU FOLLOW?**

### **Owner checks and services**

Certain basic maintenance checks and inspections should be performed by the owner or a service technician at the intervals indicated. Service information and supporting specifications are provided in this owner's guide.

Any adverse condition should be brought to the attention of your dealer or qualified service technician as soon as possible for the proper service advice. The owner maintenance service checks are generally not covered by warranties so you may be charged for labor, parts or lubricants used.

#### **Maximum oil change interval**

- 7,500 miles (12,000 km) or 6 months, whichever comes first

#### **Engine coolant change interval**

- Initial change – 6 years or 105,000 miles (168,000 km) (whichever comes first)
- After initial change - every 3 years or 45,000 miles (72,000 km)

#### **Check every month**

- Check function of all interior and exterior lights
- Check tires for wear and correct air pressure, including spare tire
- Check windshield washer fluid level
- Check engine oil level

## Scheduled Maintenance Guide

### Check every six months

- Check lap/shoulder belts and seat latches for wear and function
- Check parking brake for proper operation
- Check safety warning lamps (brake, ABS, airbag, safety belt) for operation
- Check cooling system fluid level and coolant strength
- Check battery connections and clean if necessary
- Check washer spray, wiper operation and clean all wiper blades (replace as necessary)
- Check and lubricate all hinges, latches and outside locks. Inspect for correct operation
- Check and lubricate door rubber weatherstrips; inspect for excessive wear
- Check and clean body and door drain holes. Inspect for clogs and obstructions

### Multi-point inspection

In order to keep your vehicle running right, it is important to have the systems on your vehicle checked regularly. This can help identify potential issues and prevent major problems. Ford Motor Company recommends the following multi-point inspection be performed at every scheduled maintenance interval to help ensure your vehicle keeps running great.





### Multi-point inspection - Recommended at every visit

- Check and top-up fluid levels: brake, coolant recovery reservoir, manual and automatic transmission (if equipped with an underhood dipstick), power steering (if equipped) and window washer
- Inspect tires for wear and check air pressure, including spare.
- Check exhaust system for leaks, damage, loose parts and foreign material.
- Check battery performance.
- Check operation of horn, exterior lamps, turn signals and hazard warning lights.
- Check radiator, coolers, heater and air conditioning hoses.
- Inspect windshield washer spray and wiper operation.
- Check windshield for cracks, chips and pitting.
- Inspect for oil and fluid leaks.
- Inspect engine air filter.
- Inspect half shaft dust boots, if equipped.
- Check shocks and struts and other suspension components for leaks and damage.
- Inspect steering and linkage.
- Inspect accessory drive belt(s).
- Inspect clutch operation, if equipped.

Be sure to ask your Ford or Lincoln Mercury dealership service advisor or technician about the multi-point vehicle inspection. It's a comprehensive way to perform a thorough inspection of your vehicle. It's your checklist that gives you immediate feedback on the overall condition of your vehicle. You'll know what's been checked, what's okay,

## Scheduled Maintenance Guide

as well as those things that may require future or immediate attention. The multi-point vehicle inspection is one more way to keep your vehicle running great!

 Personal Member of: \_\_\_\_\_  
 Personal Service Balance: \_\_\_\_\_

### Multi-Point Inspection Report Card as Recommended by Ford Motor Company

Name: \_\_\_\_\_ Today's Date: \_\_\_\_\_ Mileage: \_\_\_\_\_  
 E-Mail Address: \_\_\_\_\_ State Inspection Month: \_\_\_\_\_  
 Make/Model/Year: \_\_\_\_\_

SCHEDULED MAINTENANCE ITEMS DUE FOR SERVICE ON THIS VEHICLE			
Oil	Oil Filter	Oil Filter	Oil Filter
<input type="checkbox"/>	<input type="checkbox"/>	<input type="checkbox"/>	<input type="checkbox"/>
<input type="checkbox"/>	<input type="checkbox"/>	<input type="checkbox"/>	<input type="checkbox"/>
<input type="checkbox"/>	<input type="checkbox"/>	<input type="checkbox"/>	<input type="checkbox"/>
<input type="checkbox"/>	<input type="checkbox"/>	<input type="checkbox"/>	<input type="checkbox"/>
<input type="checkbox"/>	<input type="checkbox"/>	<input type="checkbox"/>	<input type="checkbox"/>
<input type="checkbox"/>	<input type="checkbox"/>	<input type="checkbox"/>	<input type="checkbox"/>

\*Please see only a partial list of vehicle maintenance items and to NOT all vehicles. Please consult your Owner's Manual or visit [www.fordmotors.com](http://www.fordmotors.com) for vehicle specific maintenance requirements.

CHECK FLUID LEVELS AND FILL			
Oil	Oil Filter	Oil Filter	Oil Filter
<input type="checkbox"/>	<input type="checkbox"/>	<input type="checkbox"/>	<input type="checkbox"/>
<input type="checkbox"/>	<input type="checkbox"/>	<input type="checkbox"/>	<input type="checkbox"/>
<input type="checkbox"/>	<input type="checkbox"/>	<input type="checkbox"/>	<input type="checkbox"/>
<input type="checkbox"/>	<input type="checkbox"/>	<input type="checkbox"/>	<input type="checkbox"/>
<input type="checkbox"/>	<input type="checkbox"/>	<input type="checkbox"/>	<input type="checkbox"/>
<input type="checkbox"/>	<input type="checkbox"/>	<input type="checkbox"/>	<input type="checkbox"/>

State of Health: \_\_\_\_\_ Condition of \_\_\_\_\_

Factory spec cold cranking amps: \_\_\_\_\_

 Note any existing exterior body damage or defects: \_\_\_\_\_

BRAKE LIVING			
Front	Left	Right	Back
<input type="checkbox"/>	<input type="checkbox"/>	<input type="checkbox"/>	<input type="checkbox"/>
<input type="checkbox"/>	<input type="checkbox"/>	<input type="checkbox"/>	<input type="checkbox"/>
<input type="checkbox"/>	<input type="checkbox"/>	<input type="checkbox"/>	<input type="checkbox"/>
<input type="checkbox"/>	<input type="checkbox"/>	<input type="checkbox"/>	<input type="checkbox"/>
<input type="checkbox"/>	<input type="checkbox"/>	<input type="checkbox"/>	<input type="checkbox"/>
<input type="checkbox"/>	<input type="checkbox"/>	<input type="checkbox"/>	<input type="checkbox"/>

Comments: \_\_\_\_\_

Service Advisor: \_\_\_\_\_ Customer Signature: \_\_\_\_\_  
 Technician: \_\_\_\_\_

2011 Expedition 1000 (2011) Ford Motor Company, All Rights Reserved. Customer Copy 12-XXXXXXXX

## Scheduled Maintenance Guide

### **NORMAL SCHEDULED MAINTENANCE AND LOG**

The following section contains the “Normal Schedule”. This schedule is presented at specific mileage (kilometer) intervals with exceptions noted.

## Scheduled Maintenance Guide

Miles (x 1,000)*	7.5	15	22.5	30	37.5	45	52.5	60	67.5	75
Kilometers (x 1,000)*	12	24	36	48	60	72	84	96	108	120
Months*	6	12	18	24	30	36	42	48	54	60
Change engine oil and filter	•	•	•	•	•	•	•	•	•	•
Rotate tires, inspect tire wear and measure tread depth. Vehicles with dual rear wheels should only rotate if unusual wear is observed.	•	•	•	•	•	•	•	•	•	•
Inspect wheels and related components for abnormal noise, wear, looseness or drag	•	•	•	•	•	•	•	•	•	•
Perform multi-point inspection (recommended)	•	•	•	•	•	•	•	•	•	•
Inspect automatic transmission fluid level (if equipped with dipstick); consult dealer for requirements.	•	•	•	•	•	•	•	•	•	•
Inspect brake pads, shoes, rotors, drums, brake linings, hoses and parking brake	•	•	•	•	•	•	•	•	•	•
Inspect engine cooling system concentration and hoses	•	•	•	•	•	•	•	•	•	•
Inspect exhaust system and heat shields	•	•	•	•	•	•	•	•	•	•
Inspect front axle and U-joints; lubricate if equipped with grease fittings (4WD vehicles)	•	•	•	•	•	•	•	•	•	•
Inspect half-shaft boots (if equipped)	•	•	•	•	•	•	•	•	•	•
Inspect steering linkage, ball joints, suspension, tie-rod ends, driveshaft and U-joints; lubricate if equipped with grease fittings	•	•	•	•	•	•	•	•	•	•
Torque rear U-bolts (Transit Connect)	•	•	•	•	•	•	•	•	•	•
Inspect cabin air filter (if equipped)	•	•	•	•	•	•	•	•	•	•

\* Whichever comes first

## Scheduled Maintenance Guide

Miles (x 1,000)*	82.5	90	97.5	105	112.5	120	127.5	135	142.5	150
Kilometers (x 1,000)*	132	144	156	168	180	192	204	216	228	240
Months*	66	72	78	84	90	96	102	108	114	120
Change engine oil and filter	•	•	•	•	•	•	•	•	•	•
Rotate tires, inspect tire wear and measure tread depth. Vehicles with dual rear wheels should only rotate if unusual wear is observed.	•	•	•	•	•	•	•	•	•	•
Inspect wheels and related components for abnormal noise, wear, looseness or drag	•	•	•	•	•	•	•	•	•	•
Perform multi-point inspection (recommended)	•	•	•	•	•	•	•	•	•	•
Inspect automatic transmission fluid level (if equipped with dipstick); consult dealer for requirements.		•		•		•		•		•
Inspect brake pads, shoes, rotors, drums, brake linings, hoses and parking brake		•		•		•		•		•
Inspect engine cooling system concentration and hoses		•		•		•		•		•
Inspect exhaust system and heat shields		•		•		•		•		•
Inspect front axle and U-joints; lubricate if equipped with grease fittings (4WD vehicles)		•		•		•		•		•
Inspect half-shaft boots (if equipped)		•		•		•		•		•
Inspect steering linkage, ball joints, suspension, tie-rod ends, driveshaft and U-joints; lubricate if equipped with grease fittings		•		•		•		•		•
Torque rear U-bolts (Transit Connect)		•		•		•		•		•
Inspect cabin air filter (if equipped)	•		•		•		•		•	

\* Whichever comes first

## Scheduled Maintenance Guide

Every 15,000 miles (24,000 km)	Replace cabin air filter (if equipped)
Every 30,000 miles (48,000 km)	Replace climate-controlled seat filter (if equipped)
	Replace engine air filter
	Replace fuel filter (Ranger)
Every 37,500 miles (60,000 km)	Inspect valve clearances; adjust as necessary (Transit Connect CNG vehicles)
Every 60,000 miles (96,000 km)	Change automatic transmission fluid and filter on 5-speed TorqShift® transmission; consult dealer for requirements.
	Replace front wheel bearing grease/grease seal if non-sealed bearings are used (2WD vehicles)
Every 105,000 miles (168,000 km)	Change engine coolant <sup>1</sup>
	Change manual transmission fluid (except Escape)
	Change rear axle fluid (Dana axles)
	Replace spark plugs
	Inspect accessory drive belt(s) <sup>2</sup>
Every 150,000 miles (240,000 km)	Change automatic transmission fluid and filter (except 5-speed TorqShift® transmission) (filter not required on 6F35, 6F50, DPS6 and AWF-21 transmissions); consult dealer for requirements.
	Change front axle fluid (4WD vehicles)
	Change manual transmission fluid (Escape)
	Change rear axle fluid (RWD vehicles)
	Change transfer case fluid (4WD vehicles)
	Replace accessory drive belt(s) if not replaced within the last 100,000 miles (160,000 km)
Replace front wheel bearings and seals if non-sealed bearings are used (2WD vehicles)	
<sup>1</sup> Initial replacement at 105,000 miles (160,000 km) or 72 months; every 45,000 miles (72,000 km) or 36 months thereafter	
<sup>2</sup> Perform a follow-up inspection at 120,000 miles (192,000 km)	



## Scheduled Maintenance Guide

**Maintenance schedule log**

<p style="text-align: center;">DEALER VALIDATION:</p> <p style="text-align: center;">P&amp;A CODE:</p> <p>RO#:                    HOURS:</p> <p>DATE:                   MILEAGE:</p>	<p style="text-align: center;">DEALER VALIDATION:</p> <p style="text-align: center;">P&amp;A CODE:</p> <p>RO#:                    HOURS:</p> <p>DATE:                   MILEAGE:</p>
<p style="text-align: center;">DEALER VALIDATION:</p> <p style="text-align: center;">P&amp;A CODE:</p> <p>RO#:                    HOURS:</p> <p>DATE:                   MILEAGE:</p>	<p style="text-align: center;">DEALER VALIDATION:</p> <p style="text-align: center;">P&amp;A CODE:</p> <p>RO#:                    HOURS:</p> <p>DATE:                   MILEAGE:</p>
<p style="text-align: center;">DEALER VALIDATION:</p> <p style="text-align: center;">P&amp;A CODE:</p> <p>RO#:                    HOURS:</p> <p>DATE:                   MILEAGE:</p>	<p style="text-align: center;">DEALER VALIDATION:</p> <p style="text-align: center;">P&amp;A CODE:</p> <p>RO#:                    HOURS:</p> <p>DATE:                   MILEAGE:</p>
<p style="text-align: center;">DEALER VALIDATION:</p> <p style="text-align: center;">P&amp;A CODE:</p> <p>RO#:                    HOURS:</p> <p>DATE:                   MILEAGE:</p>	<p style="text-align: center;">DEALER VALIDATION:</p> <p style="text-align: center;">P&amp;A CODE:</p> <p>RO#:                    HOURS:</p> <p>DATE:                   MILEAGE:</p>
<p style="text-align: center;">DEALER VALIDATION:</p> <p style="text-align: center;">P&amp;A CODE:</p> <p>RO#:                    HOURS:</p> <p>DATE:                   MILEAGE:</p>	<p style="text-align: center;">DEALER VALIDATION:</p> <p style="text-align: center;">P&amp;A CODE:</p> <p>RO#:                    HOURS:</p> <p>DATE:                   MILEAGE:</p>

## Scheduled Maintenance Guide

<p style="text-align: center;">DEALER VALIDATION:</p>  <p style="text-align: center;">P&amp;A CODE:</p> <p>RO#:            HOURS:</p> <p>DATE:           MILEAGE:</p>	<p style="text-align: center;">DEALER VALIDATION:</p>  <p style="text-align: center;">P&amp;A CODE:</p> <p>RO#:            HOURS:</p> <p>DATE:           MILEAGE:</p>
<p style="text-align: center;">DEALER VALIDATION:</p>  <p style="text-align: center;">P&amp;A CODE:</p> <p>RO#:            HOURS:</p> <p>DATE:           MILEAGE:</p>	<p style="text-align: center;">DEALER VALIDATION:</p>  <p style="text-align: center;">P&amp;A CODE:</p> <p>RO#:            HOURS:</p> <p>DATE:           MILEAGE:</p>
<p style="text-align: center;">DEALER VALIDATION:</p>  <p style="text-align: center;">P&amp;A CODE:</p> <p>RO#:            HOURS:</p> <p>DATE:           MILEAGE:</p>	<p style="text-align: center;">DEALER VALIDATION:</p>  <p style="text-align: center;">P&amp;A CODE:</p> <p>RO#:            HOURS:</p> <p>DATE:           MILEAGE:</p>
<p style="text-align: center;">DEALER VALIDATION:</p>  <p style="text-align: center;">P&amp;A CODE:</p> <p>RO#:            HOURS:</p> <p>DATE:           MILEAGE:</p>	<p style="text-align: center;">DEALER VALIDATION:</p>  <p style="text-align: center;">P&amp;A CODE:</p> <p>RO#:            HOURS:</p> <p>DATE:           MILEAGE:</p>
<p style="text-align: center;">DEALER VALIDATION:</p>  <p style="text-align: center;">P&amp;A CODE:</p> <p>RO#:            HOURS:</p> <p>DATE:           MILEAGE:</p>	<p style="text-align: center;">DEALER VALIDATION:</p>  <p style="text-align: center;">P&amp;A CODE:</p> <p>RO#:            HOURS:</p> <p>DATE:           MILEAGE:</p>

## Scheduled Maintenance Guide

<p style="text-align: center;">DEALER VALIDATION:</p> <p style="text-align: center;">P&amp;A CODE:</p> <p>RO#:            HOURS:</p> <p>DATE:          MILEAGE:</p>	<p style="text-align: center;">DEALER VALIDATION:</p> <p style="text-align: center;">P&amp;A CODE:</p> <p>RO#:            HOURS:</p> <p>DATE:          MILEAGE:</p>
<p style="text-align: center;">DEALER VALIDATION:</p> <p style="text-align: center;">P&amp;A CODE:</p> <p>RO#:            HOURS:</p> <p>DATE:          MILEAGE:</p>	<p style="text-align: center;">DEALER VALIDATION:</p> <p style="text-align: center;">P&amp;A CODE:</p> <p>RO#:            HOURS:</p> <p>DATE:          MILEAGE:</p>
<p style="text-align: center;">DEALER VALIDATION:</p> <p style="text-align: center;">P&amp;A CODE:</p> <p>RO#:            HOURS:</p> <p>DATE:          MILEAGE:</p>	<p style="text-align: center;">DEALER VALIDATION:</p> <p style="text-align: center;">P&amp;A CODE:</p> <p>RO#:            HOURS:</p> <p>DATE:          MILEAGE:</p>
<p style="text-align: center;">DEALER VALIDATION:</p> <p style="text-align: center;">P&amp;A CODE:</p> <p>RO#:            HOURS:</p> <p>DATE:          MILEAGE:</p>	<p style="text-align: center;">DEALER VALIDATION:</p> <p style="text-align: center;">P&amp;A CODE:</p> <p>RO#:            HOURS:</p> <p>DATE:          MILEAGE:</p>
<p style="text-align: center;">DEALER VALIDATION:</p> <p style="text-align: center;">P&amp;A CODE:</p> <p>RO#:            HOURS:</p> <p>DATE:          MILEAGE:</p>	<p style="text-align: center;">DEALER VALIDATION:</p> <p style="text-align: center;">P&amp;A CODE:</p> <p>RO#:            HOURS:</p> <p>DATE:          MILEAGE:</p>

## Scheduled Maintenance Guide

### SPECIAL OPERATING CONDITIONS

If you operate your Ford/Lincoln/Mercury vehicle **primarily** in one of the more demanding **Special Operating Conditions** listed below, you will need to have some items maintained more frequently. If you only **occasionally** operate your vehicle under these conditions, it is not necessary to perform the additional maintenance. For specific recommendations, see your Ford or Lincoln Mercury dealership service advisor or technician.

#### Towing a trailer or using a camper or car-top carrier

**Inspect frequently, service as required**

- Inspect and lubricate U-joints
- See axle maintenance items under *Exceptions*

**Every 5,000 miles (8,000 km)**

- Inspect wheels and related components for abnormal noise, wear, looseness or drag
- Rotate tires, inspect tires for wear and measure tread depth

**Every 5,000 miles (8,000 km) or 6 months**

- Change engine oil and filter
- Inspect and lubricate U-joints

**Every 30,000 miles (48,000 km)**

- Change automatic transmission fluid (except 6R80 and TorqShift® transmissions)
- Replace front wheel bearing grease/grease seals if non-sealed bearings are used (2WD vehicles)

**Every 60,000 miles (96,000 km)**

- Change manual transmission fluid
- Change transfer case fluid (4WD vehicles)

## Scheduled Maintenance Guide

### Extensive idling and/or low-speed driving for long distances as in heavy commercial use such as delivery, taxi, patrol car or livery

- |  |   |
|--|---|
| <b>Inspect frequently, service as required</b>                                 | <ul style="list-style-type: none"><li>– Replace cabin air filter (if equipped)</li><li>– Replace engine air filter</li></ul>  |
| <b>Every 5,000 miles (8,000 km)</b>  | <ul style="list-style-type: none"><li>– Inspect brake system</li><li>– Inspect wheels and related components for abnormal noise, wear, looseness or drag</li><li>– Lubricate control arm and steering ball joints if equipped with grease fittings</li><li>– Rotate tires, inspect tires for wear and measure tread depth</li></ul> |
| <b>Every 5,000 miles (8,000 km) or 6 months</b>                                | <ul style="list-style-type: none"><li>– Inspect and lubricate U-joints</li></ul>  |
| <b>Every 5,000 miles (8,000 km), 6 months or 200 hours of engine operation</b> | <ul style="list-style-type: none"><li>– Change engine oil and filter</li></ul>  |
| <b>Every 15,000 miles (24,000 km)</b>  | <ul style="list-style-type: none"><li>– Replace fuel filter (Ranger)</li></ul>  |
| <b>Every 30,000 miles (48,000 km)</b>  | <ul style="list-style-type: none"><li>– Change automatic transmission fluid (except 6R80 and TorqShift® transmissions)</li><li>– Replace front wheel bearing grease/grease seals if non-sealed bearings are used (2WD vehicles)</li></ul>   |
| <b>Every 60,000 miles (96,000 km)</b>  | <ul style="list-style-type: none"><li>– Change transfer case fluid (4WD vehicles)</li><li>– Replace spark plugs</li></ul>   |

## Scheduled Maintenance Guide

### Operating in dusty conditions such as unpaved or dusty roads

- |   |   |
|---|---|
| <b>Inspect frequently, service as required</b>  | <ul style="list-style-type: none"><li>– Replace cabin air filter (if equipped)</li><li>– Replace engine air filter</li></ul>  |
| <b>Every 5,000 miles (8,000 km)</b>             | <ul style="list-style-type: none"><li>– Inspect wheels and related components for abnormal noise, wear, looseness or drag</li><li>– Rotate tires, inspect tires for wear and measure tread depth</li></ul>                                |
| <b>Every 5,000 miles (8,000 km) or 6 months</b> | <ul style="list-style-type: none"><li>– Change engine oil and filter</li><li>– Inspect and lubricate U-joints</li></ul>   |
| <b>Every 15,000 miles (24,000 km)</b>           | <ul style="list-style-type: none"><li>– Replace fuel filter (Ranger)</li></ul>  |
| <b>Every 30,000 miles (48,000 km)</b>           | <ul style="list-style-type: none"><li>– Change automatic transmission fluid (except 6R80 and TorqShift® transmissions)</li><li>– Replace front wheel bearing grease/grease seals if non-sealed bearings are used (2WD vehicles)</li></ul> |
| <b>Every 50,000 miles (80,000 km)</b>           | <ul style="list-style-type: none"><li>– Change manual transmission fluid</li><li>– Change rear axle lubricant (E-450 and F-450/550 only)</li></ul>  |
| <b>Every 60,000 miles (96,000 km)</b>           | <ul style="list-style-type: none"><li>– Change transfer case fluid (4WD vehicles)</li></ul>   |

## Scheduled Maintenance Guide

### Off-road operation

- |   |   |
|---|---|
| <b>Inspect frequently, service as required</b>  | <ul style="list-style-type: none"><li>– Inspect steering linkage, ball joints and U-joints; lubricate if equipped with grease fittings</li><li>– Replace cabin air filter (if equipped)</li><li>– Replace engine air filter</li></ul>             |
| <b>Every 5,000 miles (8,000 km) or 6 months</b> | <ul style="list-style-type: none"><li>– Change engine oil and filter</li><li>– Inspect wheels and related components for abnormal noise, wear, looseness or drag</li><li>– Rotate tires, inspect tires for wear and measure tread depth</li></ul> |
| <b>Every 30,000 miles (48,000 km)</b>           | <ul style="list-style-type: none"><li>– Change automatic transmission fluid (except 6R80 and TorqShift® transmissions)</li><li>– Replace front wheel bearing grease/grease seals if non-sealed bearings are used (2WD vehicles)</li></ul>         |
| <b>Every 50,000 miles (80,000 km)</b>           | <ul style="list-style-type: none"><li>– Change manual transmission fluid</li><li>– Change rear axle lubricant (E-450 and F-450/550 only)</li></ul>  |
| <b>Every 60,000 miles (96,000 km)</b>           | <ul style="list-style-type: none"><li>– Change transfer case fluid (4WD vehicles)</li></ul>   |

### Exclusive use of E85 (Flex Fuel Vehicles only)

- |                         |  |
|-------------------------|--|
| <b>Every oil change</b> | <ul style="list-style-type: none"><li>– If ran exclusively on E85, fill the fuel tank full with regular unleaded fuel.</li></ul> |
|-------------------------|--|

## Scheduled Maintenance Guide

### Special operating condition log

<p style="text-align: center;">DEALER VALIDATION:</p>  <p style="text-align: center;">P&amp;A CODE:</p> <p>RO#:            HOURS:</p> <p>DATE:           MILEAGE:</p>	<p style="text-align: center;">DEALER VALIDATION:</p>  <p style="text-align: center;">P&amp;A CODE:</p> <p>RO#:            HOURS:</p> <p>DATE:           MILEAGE:</p>
<p style="text-align: center;">DEALER VALIDATION:</p>  <p style="text-align: center;">P&amp;A CODE:</p> <p>RO#:            HOURS:</p> <p>DATE:           MILEAGE:</p>	<p style="text-align: center;">DEALER VALIDATION:</p>  <p style="text-align: center;">P&amp;A CODE:</p> <p>RO#:            HOURS:</p> <p>DATE:           MILEAGE:</p>
<p style="text-align: center;">DEALER VALIDATION:</p>  <p style="text-align: center;">P&amp;A CODE:</p> <p>RO#:            HOURS:</p> <p>DATE:           MILEAGE:</p>	<p style="text-align: center;">DEALER VALIDATION:</p>  <p style="text-align: center;">P&amp;A CODE:</p> <p>RO#:            HOURS:</p> <p>DATE:           MILEAGE:</p>
<p style="text-align: center;">DEALER VALIDATION:</p>  <p style="text-align: center;">P&amp;A CODE:</p> <p>RO#:            HOURS:</p> <p>DATE:           MILEAGE:</p>	<p style="text-align: center;">DEALER VALIDATION:</p>  <p style="text-align: center;">P&amp;A CODE:</p> <p>RO#:            HOURS:</p> <p>DATE:           MILEAGE:</p>
<p style="text-align: center;">DEALER VALIDATION:</p>  <p style="text-align: center;">P&amp;A CODE:</p> <p>RO#:            HOURS:</p> <p>DATE:           MILEAGE:</p>	<p style="text-align: center;">DEALER VALIDATION:</p>  <p style="text-align: center;">P&amp;A CODE:</p> <p>RO#:            HOURS:</p> <p>DATE:           MILEAGE:</p>



## Scheduled Maintenance Guide

<p style="text-align: center;">DEALER VALIDATION:</p>  <p style="text-align: center;">P&amp;A CODE:</p> <p>RO#:            HOURS:</p> <p>DATE:          MILEAGE:</p>	<p style="text-align: center;">DEALER VALIDATION:</p>  <p style="text-align: center;">P&amp;A CODE:</p> <p>RO#:            HOURS:</p> <p>DATE:          MILEAGE:</p>
<p style="text-align: center;">DEALER VALIDATION:</p>  <p style="text-align: center;">P&amp;A CODE:</p> <p>RO#:            HOURS:</p> <p>DATE:          MILEAGE:</p>	<p style="text-align: center;">DEALER VALIDATION:</p>  <p style="text-align: center;">P&amp;A CODE:</p> <p>RO#:            HOURS:</p> <p>DATE:          MILEAGE:</p>
<p style="text-align: center;">DEALER VALIDATION:</p>  <p style="text-align: center;">P&amp;A CODE:</p> <p>RO#:            HOURS:</p> <p>DATE:          MILEAGE:</p>	<p style="text-align: center;">DEALER VALIDATION:</p>  <p style="text-align: center;">P&amp;A CODE:</p> <p>RO#:            HOURS:</p> <p>DATE:          MILEAGE:</p>
<p style="text-align: center;">DEALER VALIDATION:</p>  <p style="text-align: center;">P&amp;A CODE:</p> <p>RO#:            HOURS:</p> <p>DATE:          MILEAGE:</p>	<p style="text-align: center;">DEALER VALIDATION:</p>  <p style="text-align: center;">P&amp;A CODE:</p> <p>RO#:            HOURS:</p> <p>DATE:          MILEAGE:</p>
<p style="text-align: center;">DEALER VALIDATION:</p>  <p style="text-align: center;">P&amp;A CODE:</p> <p>RO#:            HOURS:</p> <p>DATE:          MILEAGE:</p>	<p style="text-align: center;">DEALER VALIDATION:</p>  <p style="text-align: center;">P&amp;A CODE:</p> <p>RO#:            HOURS:</p> <p>DATE:          MILEAGE:</p>

## Scheduled Maintenance Guide

### EXCEPTIONS

In addition, there are several exceptions to the Normal Schedule. They are listed below:

#### Normal vehicle axle maintenance

- Rear axles and power take-off (PTO) units containing synthetic lubricant and light duty trucks equipped with Ford-design axles are lubricated for life. These lubricants are not to be checked or changed unless a leak is suspected, service is required or the axle assembly has been submerged in water. The axle and PTO lubricant should be changed anytime the axle and PTO have been submerged in water. During extended trailer tow operation above 70°F (21°C) ambient and wide open throttle for extended periods above 45 mph (72 km/h), non-synthetic rear axle lubricants should be replaced every 3,000 miles (4,800 km) or 3 months, whichever occurs first. The 3,000 mile (4,800 km) lubricant change interval may be waived if the axle was filled with 75W140 synthetic gear lubricant meeting Ford specification WSL-M2C192-A, part number FITZ-19580-B or equivalent. Add friction modifier XL-3 (EST-M2C118-A) or equivalent for complete refill of Traction-Lok rear axles (refer to *Maintenance product and specifications* in the *Maintenance and Specifications* chapter for details). The axle lubricant should be changed anytime an axle has been submerged in water.

#### Police/Taxi/Livery vehicle axle maintenance

- Replace rear axle lubricant every 100,000 miles (160,000 km). Rear axle lubricant change may be waived if the axle was filled with 75W140 synthetic gear lubricant meeting Ford specification WSL-M2C192-A, part number FITZ-19580-B or equivalent. Add four ounces (118 mL) of additive friction modifier XL-3 (EST-M2C118-A) or equivalent for complete refill of Traction-Lok rear axles. The axle lubricant should be changed anytime the axle has been submerged in water.

#### E-450 and F-450/550 axle maintenance

- Replace rear axle lubricant every 100,000 miles (160,000 km) under normal driving conditions on all E-450 and F-450/550 applications. For E-450 and F-450/550 vehicles operated at or near maximum Gross Vehicle Weights, the rear axle lubricant should be replaced every 50,000 miles (80,000 km). In addition, this 50,000 mile (80,000 km) schedule should be observed when the vehicles are operated under the Special Operating Conditions.

#### California fuel filter replacement

- If vehicle is registered in California, the California Air Resources Board has determined that the failure to perform this maintenance item will not nullify the emission warranty or limit recall liability prior to the completion of the vehicle's useful life. Ford Motor Company, however, urges you to have all recommended maintenance services performed at the specified intervals and to record all vehicle service.

#### Class A Motorhome

- Every two years - Change brake fluid

## Scheduled Maintenance Guide

### Hot climate oil change intervals

- If operating conditions are normal and you drive your Ford, Lincoln or Mercury vehicle under typical, everyday conditions **and** you are using an API performance category oil of SL or later (for example SM, etc.) then you can follow the 7,500 mile (12,000 km) normal service oil change intervals schedule. Vehicles operating in the Middle East, North Africa, Sub-Saharan Africa or locations with similar climates must follow the oil change interval of 3,000 mile (5,000 km) if the owner is using oils defined by the American Petroleum Institute (API) performance category of API SK or earlier (for example SJ, etc.).

### Engine air filter & cabin air filter replacement

- Engine air filter and cabin air filter life is dependent on exposure to dusty and dirty conditions. Vehicles operated in these conditions will require frequent inspection and replacement of the engine air filter and cabin air filter.

## COOLANT CHANGE RECORD

### Engine coolant

- Initial change – 6 years or 105,000 miles (168,000 km) (whichever comes first).
- After initial change - every 3 years or 45,000 miles (72,000 km).

## Scheduled Maintenance Guide

### Engine coolant change log

<p style="text-align: center;">DEALER VALIDATION:</p>  <p style="text-align: center;">P&amp;A CODE:</p> <p>RO#:                    HOURS:</p> <p>DATE:                   MILEAGE:</p>	<p style="text-align: center;">DEALER VALIDATION:</p>  <p style="text-align: center;">P&amp;A CODE:</p> <p>RO#:                    HOURS:</p> <p>DATE:                   MILEAGE:</p>
<p style="text-align: center;">DEALER VALIDATION:</p>  <p style="text-align: center;">P&amp;A CODE:</p> <p>RO#:                    HOURS:</p> <p>DATE:                   MILEAGE:</p>	<p style="text-align: center;">DEALER VALIDATION:</p>  <p style="text-align: center;">P&amp;A CODE:</p> <p>RO#:                    HOURS:</p> <p>DATE:                   MILEAGE:</p>
<p style="text-align: center;">DEALER VALIDATION:</p>  <p style="text-align: center;">P&amp;A CODE:</p> <p>RO#:                    HOURS:</p> <p>DATE:                   MILEAGE:</p>	<p style="text-align: center;">DEALER VALIDATION:</p>  <p style="text-align: center;">P&amp;A CODE:</p> <p>RO#:                    HOURS:</p> <p>DATE:                   MILEAGE:</p>
<p style="text-align: center;">DEALER VALIDATION:</p>  <p style="text-align: center;">P&amp;A CODE:</p> <p>RO#:                    HOURS:</p> <p>DATE:                   MILEAGE:</p>	<p style="text-align: center;">DEALER VALIDATION:</p>  <p style="text-align: center;">P&amp;A CODE:</p> <p>RO#:                    HOURS:</p> <p>DATE:                   MILEAGE:</p>
<p style="text-align: center;">DEALER VALIDATION:</p>  <p style="text-align: center;">P&amp;A CODE:</p> <p>RO#:                    HOURS:</p> <p>DATE:                   MILEAGE:</p>	<p style="text-align: center;">DEALER VALIDATION:</p>  <p style="text-align: center;">P&amp;A CODE:</p> <p>RO#:                    HOURS:</p> <p>DATE:                   MILEAGE:</p>

## Index

### A

ABS (see Brakes) .....244  
Accessory delay .....91  
AdvanceTrac .....246  
Air cleaner filter .....348, 353  
Air suspension .....252  
description .....252  
Airbag supplemental  
restraint system .....173, 177, 179  
and child safety seats .....175  
description .....173, 177, 179  
disposal .....182  
driver airbag .....175, 178, 180  
indicator light .....177, 182  
operation .....175, 178, 180  
passenger airbag .....175, 178, 180  
side airbag .....177  
Antifreeze  
(see Engine coolant) .....328  
Anti-lock brake system  
(see Brakes) .....244  
Anti-theft system .....132, 136  
arming the system .....136  
disarming a triggered  
system .....137  
Armrests .....142  
Audio system (see Radio) .....39  
Automatic transmission  
driving an automatic  
overdrive .....256  
fluid, adding .....348  
fluid, checking .....348  
fluid, refill capacities .....354  
fluid, specification .....354  
Auxiliary input jack (Line in) ....46  
Auxiliary power point .....87

### Axle

lubricant specifications .....354  
refill capacities .....354

### B

Battery .....326  
acid, treating emergencies .....326  
jumping a disabled battery ....296  
maintenance-free .....326  
replacement, specifications ...353  
servicing .....326  
Belt-Minder® .....169  
Booster seats .....198  
Brakes .....243  
anti-lock .....244  
anti-lock brake system (ABS)  
warning light .....244  
fluid, checking and adding ....347  
fluid, refill capacities .....354  
fluid, specifications .....354  
lubricant specifications .....354  
parking .....245  
shift interlock .....254–255  
Bulbs .....76

### C

Capacities for refilling fluids ....354  
Car2U® Home Automation  
System .....101  
Cargo cover .....112  
Cargo management system .....111  
Cassette tape player .....39  
Cell phone use .....9  
Changing a tire .....286  
Child safety seats .....187  
in front seat .....188

## Index

- in rear seat .....188
  - LATCH .....191
  - recommendations .....185
  - Child safety seats - booster seats .....198
  - Cleaning your vehicle
    - engine compartment .....312
    - instrument panel .....313
    - interior .....314–315
    - plastic parts .....312
    - washing .....310
    - waxing .....311
    - wheels .....311
    - wiper blades .....313
  - Clock adjust
    - AM/FM/CD .....41
  - Compass, electronic .....23
    - calibration .....23
    - set zone adjustment .....23, 35
  - Console .....86
    - overhead .....85–86
  - Controls
    - power seat .....143
    - steering column .....98
  - Coolant
    - checking and adding .....328
    - refill capacities .....331, 354
    - specifications .....354
  - Cruise control  
(see Speed control) .....96
  - Customer Assistance .....275
    - Ford Extended Service Plan .....364, 367
    - Getting assistance outside the U.S. and Canada .....306
    - Getting roadside assistance ...275
    - Getting the service you need .....302
  - Ordering additional owner's literature .....308
  - Utilizing the Mediation/Arbitration Program .....306
- ### D
- Daytime running lamps  
(see Lamps) .....72
  - Dipstick
    - automatic transmission fluid .....348
    - engine oil .....323
  - Driving under special conditions .....259, 269, 272
    - sand .....270
    - snow and ice .....273
    - through water .....271, 274
- ### E
- Electronic message center ...20, 29
  - Emergencies, roadside
    - jump-starting .....296
    - running out of fuel .....296, 340
  - Emission control system .....344
  - Engine .....358–359
    - cleaning .....312
    - coolant .....328
    - fail-safe cooling .....332
    - idle speed control .....326
    - lubrication specifications .....354
    - refill capacities .....354
    - service points .....320
    - starting after a collision .....277
  - Engine block heater .....241
  - Engine oil .....323
    - checking and adding .....323
    - dipstick .....323

## Index

- filter, specifications .....325, 353
- recommendations .....325
- refill capacities .....354
- specifications .....354
- Event data recording .....7
- Exhaust fumes .....241
- F**
- Fail safe cooling .....332
- Fleet MyKey programming .....115
- Flexible Fuel Vehicle (FFV) ....334
- Floor mats .....106–107
- Fluid capacities .....354
- Fog lamps .....71
- Four-Wheel Drive vehicles .....264
  - control trac .....265
  - description .....265
  - driving off road .....267
  - indicator light .....265
  - preparing to drive your vehicle .....253
- Fuel .....334
  - calculating fuel economy .....23, 31, 341
  - cap .....337
  - capacity .....354
  - choosing the right fuel .....338
  - detergent in fuel .....340
  - filler funnel .....340
  - filling your vehicle with fuel .....334, 337, 341
  - filter, specifications .....334, 353
  - fuel pump shut-off switch ....277
  - improving fuel economy .....341
  - octane rating .....338, 358–359
  - quality .....339
  - running out of fuel .....296, 340
  - safety information relating to automotive fuels .....334
- Fuel - flex fuel vehicle (FFV) .....334, 338
- Fuses .....278–279
- G**
- Garage door opener .....101
- Gas cap (see Fuel cap) .....337
- Gas mileage (see Fuel economy) .....341
- Gauges .....18
- H**
- Hazard flashers .....276
- Headlamps .....71
  - aiming .....73
  - autolamp system .....71
  - bulb specifications .....77
  - daytime running lights .....72
  - flash to pass .....72
  - high beam .....72
  - replacing bulbs .....78
  - turning on and off .....71
- Heating
  - heating and air conditioning system .....60–61
- Hood .....319
- I**
- Ignition .....237, 358–359
- Illuminated visor mirror .....84
- Infant seats
  - (see Safety seats) .....187

## Index

- Inspection/maintenance (I/M)  
testing .....346
- Instrument panel  
cleaning .....313  
cluster .....12  
lighting up panel and  
interior .....73
- J**
- Jack .....286  
positioning .....286  
storage .....286
- Jump-starting your vehicle .....296
- K**
- Keyless entry system  
autolock .....120  
keypad .....130  
locking and unlocking doors ..131  
programming entry code .....130
- Keys .....114, 133  
positions of the ignition .....237
- L**
- Lamps  
autolamp system .....71  
bulb replacement  
specifications chart .....77  
daytime running light .....72  
fog lamps .....71  
headlamps .....71  
headlamps, flash to pass .....72  
instrument panel, dimming ....73  
interior lamps .....75, 78  
replacing bulbs .....78, 80
- LATCH anchors .....191
- Liftgate .....107, 111, 126
- Lights, warning and indicator ....12  
392
- anti-lock brakes (ABS) .....244
- Limited-slip axle .....253
- Load limits .....223
- Loading instructions .....230
- Locks  
autolock .....120  
childproof .....124  
doors .....120
- Lubricant specifications .....354
- Lug nuts .....295
- Lumbar support, seats .....142–143
- M**
- Message center .....20, 29  
english/metric button .....26, 35  
system check button .....35  
warning messages .....26, 35
- Mirrors .....91–92  
automatic dimming rearview  
mirror .....91  
fold away .....93  
heated .....93–94  
programmable memory .....127  
signal .....94
- Moon roof .....100
- Motorcraft® parts .....317, 353
- MyKey .....115
- N**
- Navigation system .....59
- O**
- Octane rating .....338
- Oil (see Engine oil) .....323

<https://www.MyCarManual.com>



## Index

### P

Parental MyKey programming .....115  
Parking brake .....245  
Parts  
(see Motorcraft® parts) .....353  
Pedals (see Power adjustable foot pedals) .....94  
Power adjustable foot pedals .....94  
Power deployable running boards .....95  
Power distribution box (see Fuses) .....279, 282  
Power door locks .....120  
Power liftgate .....107  
Power mirrors .....92  
Power point .....87  
Power steering .....251  
    fluid, checking and adding ....347  
    fluid, refill capacity .....354  
    fluid, specifications .....354  
Power Windows .....89  
Preparing to drive your vehicle .....253

### R

Radio .....39  
Rear heated seats .....155  
Rear-view camera system .....262  
Recommendations for attaching safety restraints for children .....185  
Relays .....278  
Remote entry system .....124–125

illuminated entry .....129  
locking/unlocking doors .....125–126  
opening the trunk .....126  
panic alarm .....127  
replacement/additional transmitters .....129  
replacing the batteries .....128  
Reverse sensing system .....260  
Roadside assistance .....275  
Roll stability control .....246

### S

Safety Belt Maintenance .....201  
Safety belts (see Safety restraints) ....159, 161, 163–164, 167  
Safety Canopy .....177, 179  
Safety defects, reporting .....309  
Safety restraints .....159, 161, 163–164, 166–167  
    Belt-Minder® .....169  
    extension assembly .....168  
    for adults .....163–164  
    for children .....183  
    safety belt maintenance .....201  
    warning light and chime .....169  
Safety restraints - LATCH anchors .....191  
Safety seats for children .....187  
Safety Compliance Certification Label .....359  
Satellite Radio Information .....56  
Scheduled Maintenance Guide  
    Normal Scheduled Maintenance and Log .....373

<https://www.MyCarManual.com>

393

## Index

- What Maintenance Schedule  
Should You Follow? .....370
- Seats .....138  
child safety seats .....187  
cleaning .....316  
climate control .....147  
heated .....155  
memory seat .....127, 145
- SecuriCode keyless entry  
system .....130
- SecuriLock passive anti-theft  
system .....132–133
- Servicing your vehicle .....318
- Setting the clock  
AM/FM single CD .....41
- Snowplowing .....6
- SOS Post Crash Alert .....182
- Spark plugs, specifications .....353,  
358–359
- Special notice  
utility-type vehicles .....6
- Specification chart, lubricants .354
- Speed control .....96
- Stability system .....246
- Starting a flex fuel vehicle .....240
- Starting your vehicle .....237–240  
jump starting .....296
- Steering wheel  
controls .....98  
tilting .....84
- SYNC® .....59
- T**
- Third-row power fold seat .....158
- Tilt steering wheel .....84
- 394
- Tire Pressure Monitoring  
System (TPMS)  
Driving .....270  
Tires, Wheels and Loading ....219  
Warning Displays .....12, 26, 35
- Tires .....204–206, 286  
alignment .....213  
care .....209  
changing .....286, 290  
checking the pressure .....209  
inflating .....207  
label .....218  
replacing .....211  
rotating .....213  
safety practices .....212  
sidewall information .....214  
snow tires and chains .....223  
spare tire .....286  
terminology .....206  
tire grades .....205  
treadwear .....205, 209
- Towing .....231  
recreational towing .....236  
trailer towing .....231  
wrecker .....300
- Transmission .....256  
brake-shift interlock  
(BSI) .....254–255  
fluid, checking and adding  
(automatic) .....348  
fluid, refill capacities .....354  
lubricant specifications .....354
- Turn signal .....74
- U**
- Universal garage door  
opener .....101
- USB port .....48

<https://www.MyCarManual.com>

## Index

<b>V</b>	
Vehicle Identification Number (VIN) .....	360
Vehicle loading .....	223
Ventilating your vehicle .....	241
<b>W</b>	
Warning lights (see Lights) .....	12
Washer fluid .....	321
Water, Driving through .....	274
Windows	
power .....	89
rear wiper/washer .....	84
Windshield washer fluid and wipers .....	82
checking and adding fluid .....	321
liftgate reservoir .....	321
replacing wiper blades .....	322
Wrecker towing .....	300