

Contents

Before driving

Introduction	2
Instrumentation	5
Controls and features	20
Seating and safety restraints	72

Starting and driving

Starting	100
Driving	107
Roadside emergencies	134

Servicing

Maintenance and care	155
Capacities and specifications	213
Reporting safety defects	221
Index	222

Introduction

ICONS AND WARNINGS

ICONS

Indicates a warning. Read the following section on *Warnings* for a full explanation of them.



Indicates that vehicle information related to recycling and other environmental concerns will follow.



We must all play our part in protecting the environment. Correct vehicle usage and the authorized disposal of waste cleaning and lubrication materials are significant steps towards this aim.

WARNINGS

How can you reduce the risk of personal injury and prevent possible damage to others, your vehicle and its equipment?

In this owner's guide, answers to such questions are contained in comments highlighted by the warning triangle symbol.

NOTICE TO OWNERS OF UTILITY TYPE VEHICLES

Before you drive your vehicle, please read this owner's guide carefully. Your vehicle is not a passenger car. In vehicles of this type, incorrect operation may result in unpredictable handling behavior. Be sure to read *Control Trac - Automatic Four-Wheel Drive System (if equipped)* in the

Driving chapter as well as the special “Four Wheeling” supplement included with AWD and 4WD vehicles.

BREAKING-IN YOUR VEHICLE

There are no particular breaking-in rules for your vehicle. Simply avoid driving too briskly during the first 1,600 km (1,000 miles) of driving. Vary speeds frequently. This is necessary to give the moving parts a chance to break in.

If possible, you should avoid full use of the brakes for the first 1,600 km (1,000 miles).

From 1,600 km (1,000 miles) onwards you can gradually increase the performance of your vehicle up to the permitted maximum speeds.

INFORMATION ABOUT THIS GUIDE

The information found in this guide was in effect at the time of printing. Ford may change the contents without notice and without incurring obligation.

SPECIAL NOTICES

Using your vehicle as an ambulance



Do not use this vehicle as an ambulance.

Introduction

Using your vehicle as a snowplow



Do not use this vehicle for snowplowing.

Instrumentation

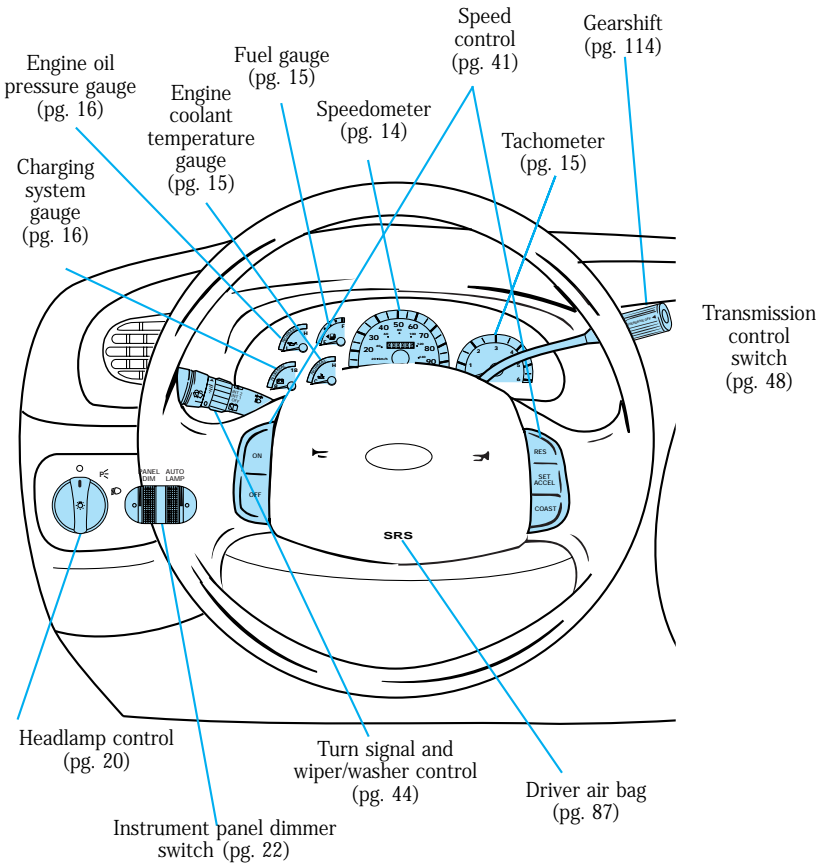

Instrumentation

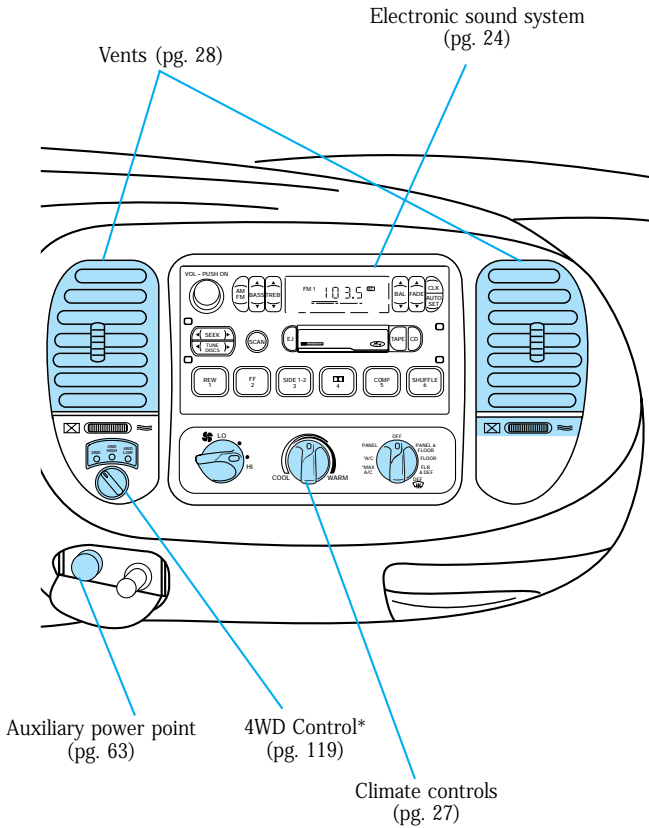

* if equipped

Instrumentation

INSTRUMENT CLUSTER WARNING LIGHTS AND CHIMES

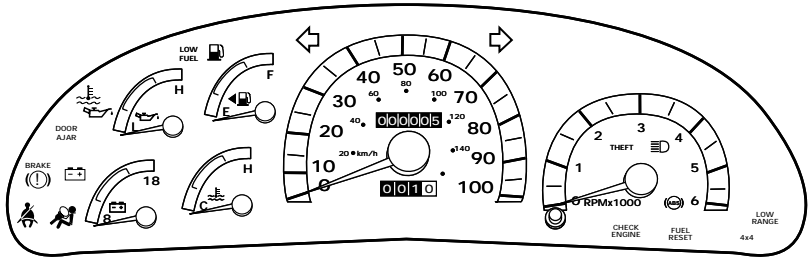

Your vehicle is equipped with the following instrument cluster:

Low fuel

Illuminates when the fuel level is low.



Engine coolant temperature

Illuminates briefly when the ignition key is turned to On. Illuminates when the engine coolant temperature is high. Stop the engine and check the engine coolant level as soon as possible. Refer to *Checking and adding engine coolant* and *What you should know about fail-safe cooling* in the *Maintenance and care* section.



Low washer fluid

Illuminates briefly when the ignition is turned to On. Also illuminates when the windshield washer fluid is low.

**LOW
WASH**

Oil pressure

Illuminates briefly when the ignition key is turned to On. Illuminates when the oil pressure is low. Stop the engine and check the engine oil level as soon as possible. Refer to *Checking and adding engine oil* in the *Maintenance and care* section.

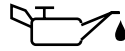

The oil pressure and engine coolant warning lights share the same lightbulb — if one of the warning lights illuminates, they both do.

Door ajar

Illuminates when the ignition switch is in the ON or START position and any door is open.

**DOOR
AJAR**

Charging system

Briefly illuminates when the ignition is turned on and the engine is off. The light also illuminates when the battery is not charging properly, requiring electrical system service.

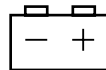

Instrumentation

Brake system warning

Extinguishes when the parking brake is released. Illumination after releasing the parking brake indicates low brake fluid level.



Safety belt

Illuminates when the ignition is switched on to remind you to fasten your safety belts. For more information, refer to *Using the safety restraints properly* in the *Seating and safety restraints* chapter.



Air bag readiness

Briefly illuminates when the ignition is turned to On. If the light fails to illuminate, continues to flash or remains on, have the system serviced. For more information, refer to *Supplemental restraints system (SRS)* in the *Seating and safety restraints* chapter.



Check engine warning light

This light illuminates when the engine's Emission Control System requires service. It will also illuminate when the ignition key is in the On position and the engine is off. Refer to *What you should know about the On-board diagnostic (OBD II) system* in the *Maintenance and care* chapter.



Transmission control indicator light (TCIL)

The TCIL (OFF), located on the end of the gearshift lever, may flash steadily if a malfunction has been detected. If the TCIL is flashing, contact your Ford dealer as soon as possible. If this condition persists, damage to the transmission could occur.

For more information, refer to the *Driving* chapter.

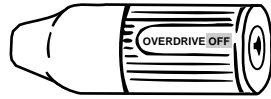

Automatic four wheel drive indicator (if equipped)

Illuminates when A4WD (automatic 4-wheel drive) is engaged.

A4WD

4x4 (if equipped)

Illuminates when the 4H (Four-Wheel Drive) or 4L (Four-Wheel Drive Low) is engaged.

4x4

4x4 low range (if equipped)

Illuminates when 4L (Four-Wheel Drive Low) is engaged.

**LOW
RANGE**

Instrumentation

Anti-lock brake system (ABS)

Momentarily illuminates when the ignition is turned on and the engine is off. If the light stays on or continues to flash, the ABS needs to be serviced.



Fuel reset

Illuminates when the ignition key is turned to the ON position and the fuel pump shut-off switch has been activated. For more information, refer to *Fuel pump shut-off switch* in the *Roadside emergencies* chapter.

FUEL
RESET

Anti-theft system

Briefly illuminates when the ignition is turned to the ON position to verify that the passive anti-theft system is operating properly.

THEFT

High beams

Illuminates when the headlamp high beams are on.



Turn signal

Illuminates when the left or right turn signal or the hazard lights are turned on.

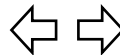

Check air suspension

Illuminates briefly when the ignition is turned to the ON position and the engine is OFF. The light also illuminates when the air suspension system requires servicing.

**CHECK
SUSP**

Testing warning lights

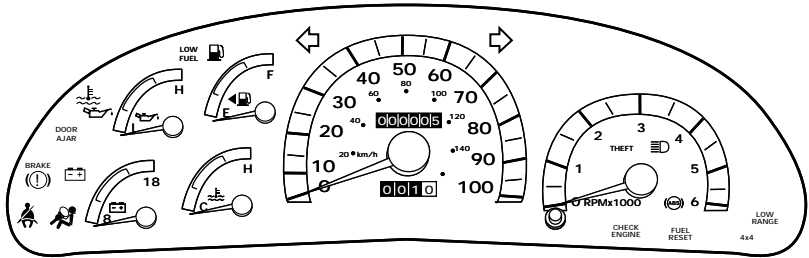

Turn the ignition key to ON without starting the vehicle. The warning and indicator lights shown above will illuminate for a brief time. If any of these lights do not illuminate, contact your dealer for service.

Safety belt warning chime

For information on the safety belt warning chime, refer to the *Seating and safety restraints* chapter.

Supplemental restraint system (SRS) warning chime

For information on the SRS warning chime, refer to the *Seating and safety restraints* chapter.

Instrumentation

Key-in-ignition warning chime

Sounds when the key is left in the ignition in the OFF/LOCK or ACC position and the driver's door is opened.

Headlamps on warning chime

Sounds when the headlamps are on, the ignition is off (and the key is not in the ignition) and the driver's door is opened.

INSTRUMENT CLUSTER GAUGES

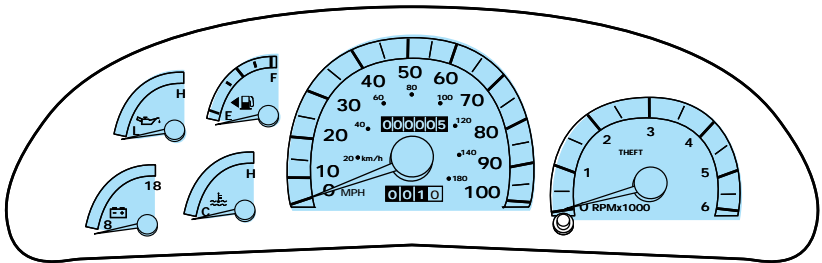

Speedometer

Indicates the current vehicle speed.

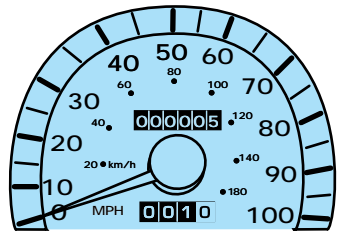

Tachometer

Indicates the engine speed in revolutions per minute.

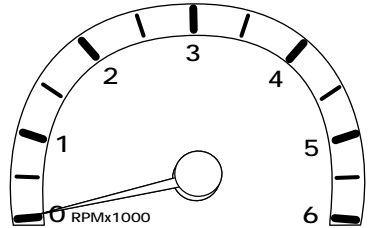

Engine coolant temperature gauge

Indicates the temperature of the engine coolant. At normal operating temperature, the needle remains within the normal zone. If it enters the red section, the engine is overheating. Switch off the engine and allow it to cool. Refer to *Checking and adding engine coolant* and *What you should know about fail-safe cooling* in the *Maintenance and care* chapter.

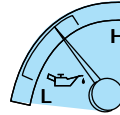

Fuel gauge

For information on the capacity of the fuel tank, refer to the *Capacities and specifications* chapter.

The fuel gauge displays approximately how much fuel is in the fuel tank only when the ignition is ON. For proper fuel gauge indication after adding fuel, turn the ignition switch OFF while refueling the vehicle.

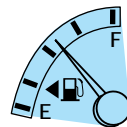

Instrumentation

The fuel gauge indicator may vary slightly when the vehicle is in motion. The most accurate reading is obtained with the vehicle on level ground.

With ignition switch OFF, the fuel gage indicator may drift from the ignition switch ON position.

Refer the *Ignition* information in the *Controls and features* chapter for more information on the positions of the ignition.

Charging system gauge

If the pointer moves and stays outside of the normal range, have the vehicle's electrical system checked as soon as safely possible.

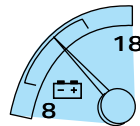

Engine oil pressure gauge

Indicates the engine oil pressure in the system. Sufficient pressure exists as long as the needle is in the normal range. If the gauge constantly indicates low pressure at normal engine speed, refer to *Checking and adding engine oil* in the *Maintenance and care* chapter.

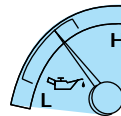

If the gauge indicates a low pressure and the engine oil level is correct, switch off the engine immediately and have the vehicle

Instrumentation

checked by your dealer or qualified service technician.

Odometer

Registers the total number of miles the vehicle has traveled.

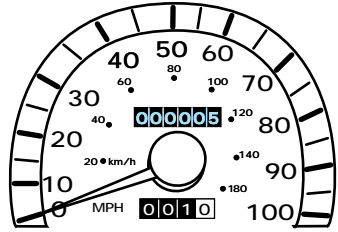

Trip odometer

Registers the number of miles traveled on individual journeys. To reset, depress the control.

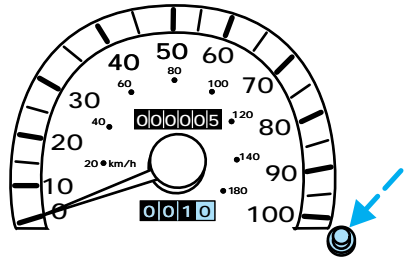

TRIP COMPUTER (IF EQUIPPED)

With the ignition control in the ON position, the trip computer displays important vehicle information through a constant monitor of vehicle systems. You may select display features on the message center for a display of status.

For more information on the overhead console of your vehicle,

310 5
km TO EMPTY

Instrumentation

refer to trip computer information in the *Controls and features* chapter.

Selectable features

English/metric display

Press the E/M control to change to message center display from metric to English units or vice versa.

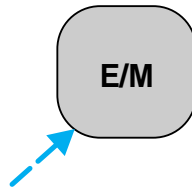

Compass

Press the mode control once for compass only display.

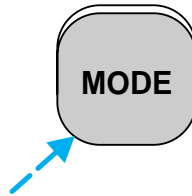

Fuel range

Press the mode control to display the approximate number of kilometers (miles) left to drive before the fuel tank is empty.

The indicated distance to empty may be inaccurate with sustained, drastic changes in fuel economy (e.g. towing with a trailer), but will eventually recover.

Fuel economy

Press the mode control to display your vehicle's average fuel economy in liters/100 kilometers (miles/gallon).

Press the mode control to display the instantaneous fuel economy of your running vehicle.

Distance to empty display may be inaccurate if the vehicle is started while parked on an incline.

Fuel fills of less than 22.7 liters (six gallons) may not be detected by the trip computer.

Off

Press the mode control a final time to turn the trip computer display off.

Controls and features

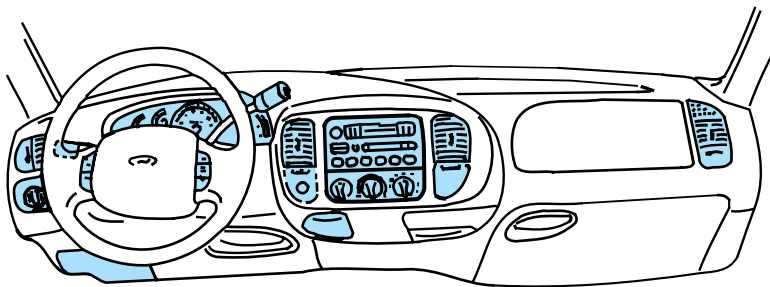

Headlamp/foglamp control

Rotate the headlamp control to the desired position:

○ — OFF.

P< — Parking lamps on.

☾ — Headlamps on.

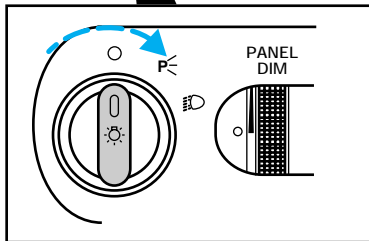
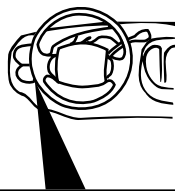

Foglamp control (if equipped)

The headlamp control also operates the foglamps. The foglamps can be turned on only when the headlamps are in the ☾ position.

Pull headlamp control towards you to turn foglamps on. The foglamp indicator light ☾ (located to the right of the control) will illuminate.

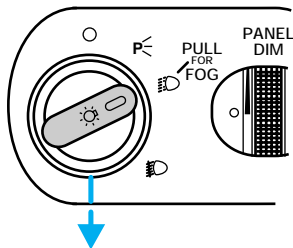

Autolamp control (if equipped)

The autolamp system provides light sensitive automatic on-off control of the exterior lights normally controlled by the headlamp control.

The autolamp system also keeps the lights on for a preselected period of time after the ignition switch is turned to Off.

- To turn autolamps on, rotate the control up. The preselected time lapse is adjustable up to approximately three minutes by continuing to rotate the control upward.
- To turn autolamps off, rotate the control down until it clicks.
- A small LED illuminates under the autolamp control to indicate that the headlamps have been turned on by the autolamps.
- Foglamps are not controlled by the autolamps. In order to turn on the foglamps, you must turn the lamp switch to the  position and pull for fog.

Daytime running light (Canadian vehicles only)

The daytime running light system turns the headlamps on, with a reduced light output, when:

- the vehicle is running
- the parking brake is released
- the headlamp system is in the  position

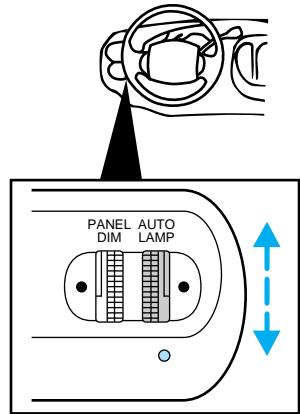

Controls and features



The Daytime Running Light (DRL) system will not illuminate the tail lamps and parking lamps. Turn on your headlamps at dusk. Failure to do so may result in a collision.

Panel dimmer control

- Turn the control up to brighten the panel.
- Turn the control down to dim the panel.
- Rotate the control up until it clicks to turn on the interior lights.

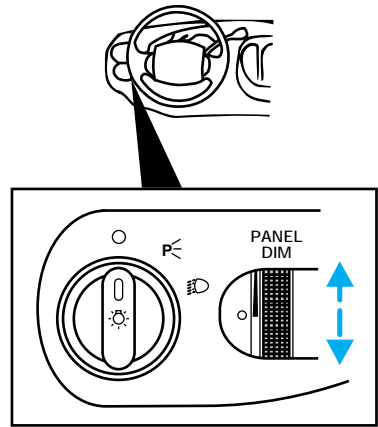

Controls and features

4WD control (if equipped)

This control operates the Control Trac 4WD. Refer to *Control trac system* in the *Driving* chapter for more information.

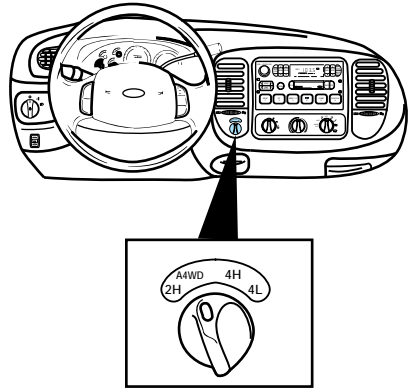

Auxiliary power point

This 12V power point is an additional power source for electrical accessories.

Do not plug optional electrical accessories into the cigarette lighter. Use the power point.

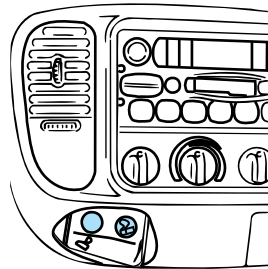

Controls and features

Audio system

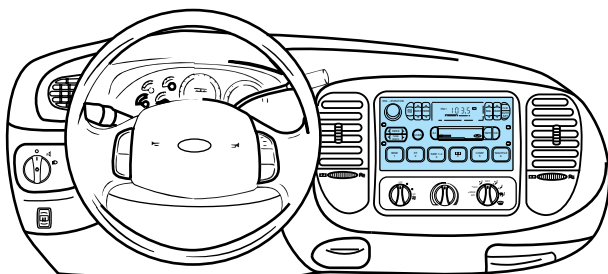

Refer to the “Audio Guide” in your Owner Portfolio.

Fuel pump shut-off switch

Refer to the *Roadside emergencies* chapter for information on operating the fuel pump shut-off switch.

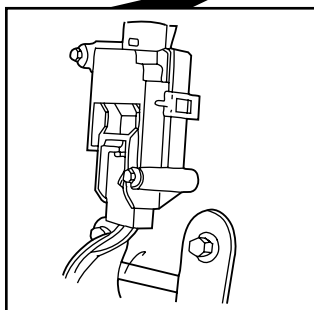
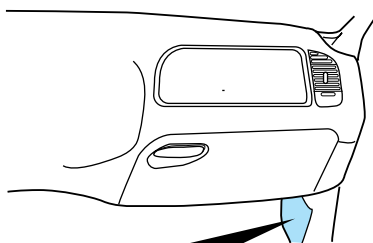

Air suspension load leveling on/off switch (if equipped)

Your vehicle is equipped with an air suspension system that levels your vehicle when carrying heavy loads. Refer to *Air suspension load leveling* in the *Driving* chapter for more information.

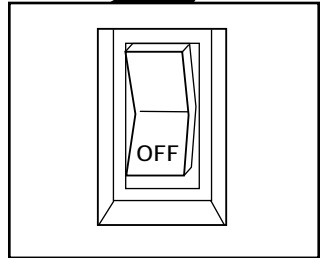
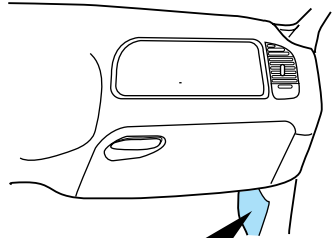

Controls and features

Rear window defroster

Press the defroster control to clear the rear window of thin ice and fog.

- The small LED will illuminate when the defroster is activated.

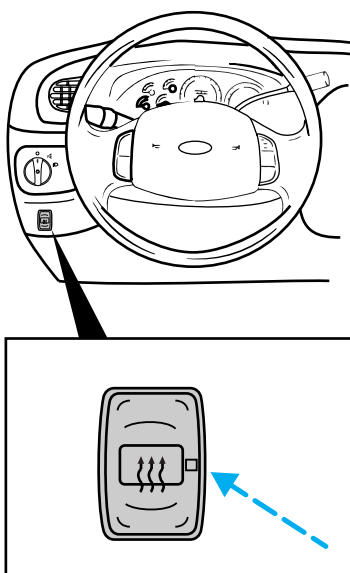

The ignition must be in the ON position to operate the rear window defroster.

The defroster turns off automatically after 10 minutes or when the ignition is turned to the OFF position. To manually turn off the defroster before ten minutes have passed, push the control again.

Parking brake

For information on the parking brake, refer to *Preparing to start the vehicle* in the *Driving* chapter.

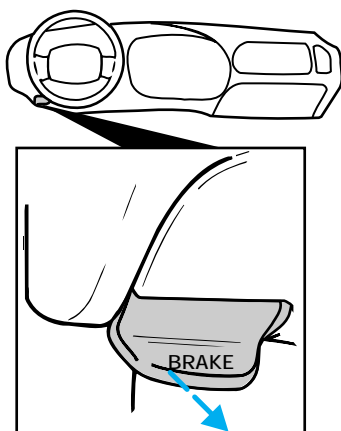

CLIMATE CONTROL

Operating the instrument panel controls

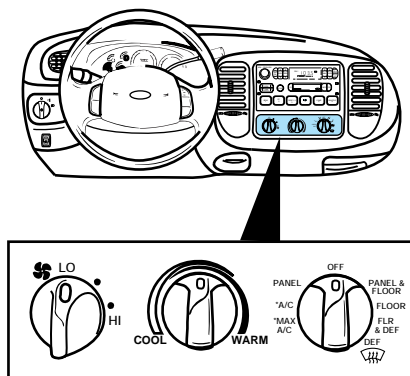

Controls and features

Instrument panel vents

There are four vents on the instrument panel. These vents are equipped with dials to adjust the amount and direction of air passing through them.

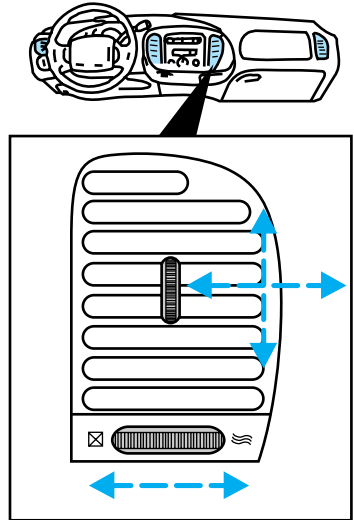

Temperature

Turn temperature control to the desired temperature.

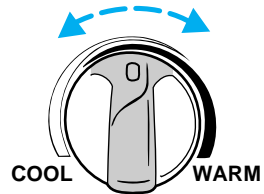

Controls and features

Fan speed

Turn the fan speed control to the desired speed.

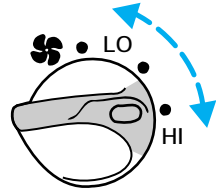

Airflow and air conditioning

Turn the mode control to the desired airflow position.

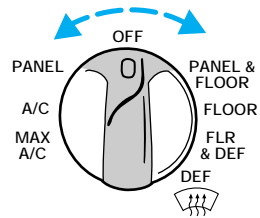

Controlling airflow

Select PANEL for air to flow through these vents:

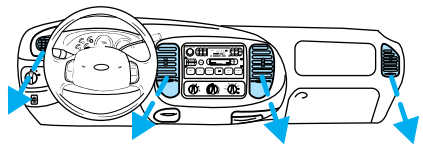

The PANEL position allows outside air to flow through the instrument panel vents.

Controls and features

Select **PANEL & FLOOR** for air to flow through these vents:

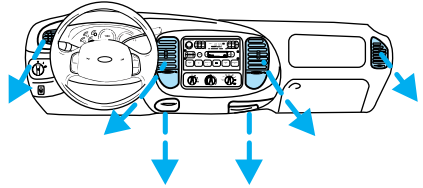

The **PANEL & FLOOR** position directs outside air to flow between the panel and floor vents. The air conditioning system will function in this mode provided the outside temperature is above 10°C (50°F).

Select **FLOOR** for air to flow through these vents:

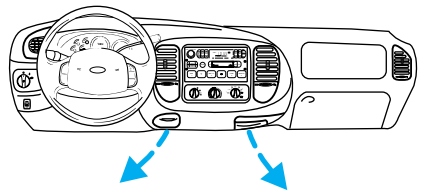

The **FLOOR** position directs outside air to flow through the floor vents.

Controls and features

Select FLR & DEF for air to flow through these vents:

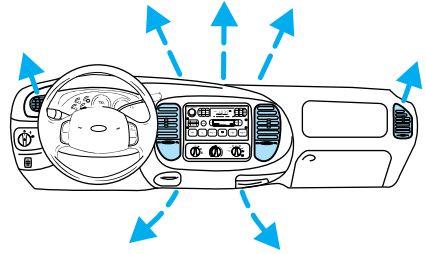

The FLR & DEF position directs outside air to flow through the floor vents and the windshield defroster vents. The air conditioning system will function in this mode provided the outside temperature is above 10°C (50°F).

Select  for air to flow through these vents:

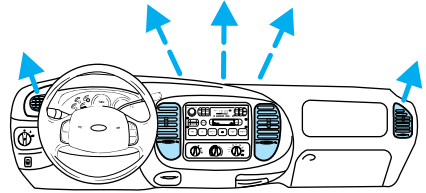

The  position directs outside air to flow through the windshield defroster vents. The air conditioning system will function in this mode provided the outside temperature is above 10°C (50°F).

Controls and features

Air conditioning

Select A/C for air conditioned air to flow through these vents:

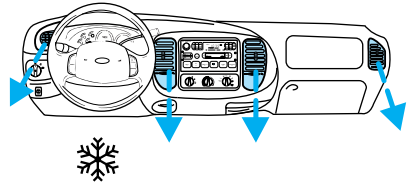

The A/C mode directs outside air conditioned air to flow through the instrument panel vents. The A/C mode can be used for heating, ventilating and defogging the windows or air conditioning. The A/C system only functions if the outside temperature is above 10°C (50°F).

Select MAX A/C for air to flow through these vents:

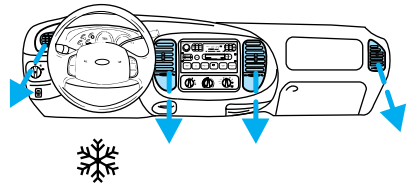

The MAX A/C mode recirculates the cabin air and directs it to flow through the instrument panel vents. This mode is noisier but more economical than the A/C mode. The air conditioning system only functions if the outside temperature is above 10°C (50°F).

Controls and features

OFF position

Select the OFF position for all climate control functions to cease. The outside inlet door will close and the fan is shut off.

Maximum heating

Set mode control to FLOOR, turn temperature control to maximum heat (red) and set fan speed control to HI.

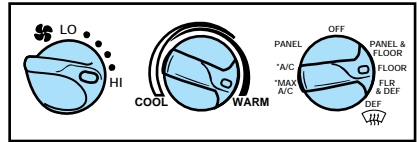

Maximum cooling

Set mode control to MAX A/C, turn the temperature control to maximum cool (blue) and set fan speed control to HI.

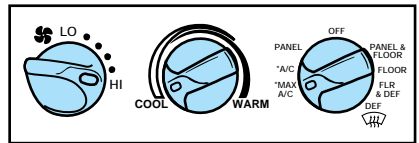

Controls and features

Ventilating with outside air

Set mode control to any mode except MAX A/C, turn the temperature control to the desired temperature and turn fan speed control to the desired speed.

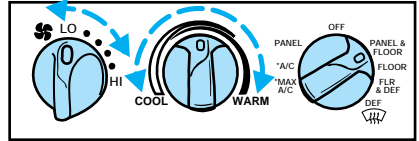

Defrosting windshield

Set mode control to  or FLR & DEF, turn temperature control to maximum heat (red) and set fan speed control to HI.

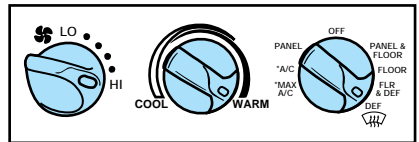

Drive with the climate control system on (in either the heating or air conditioning mode) to reduce humidity in your vehicle.

To prevent air intake restriction, remove any snow, ice or leaves from the air intake area located directly under the windshield.

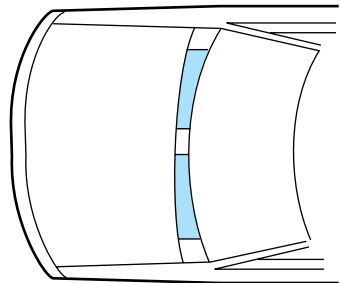

Controls and features

Auxiliary A/C controls (if equipped)

The auxiliary air conditioning feature provides increased capacity to quickly heat or cool the vehicle. Besides the overhead control panel for the front seat occupants, the auxiliary air conditioning controls allow the rear passengers to control the temperature in the rear of the vehicle through a second control panel above the second row seat.

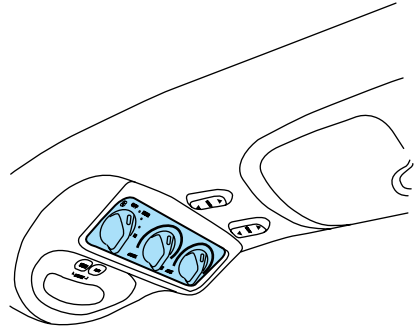

In order for the auxiliary air conditioning controls to function, the driver's auxiliary air conditioning control must be set to REAR.

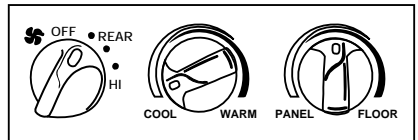

Controls and features

The instrument panel climate controls must be on in order for the auxiliary air conditioning to operate.

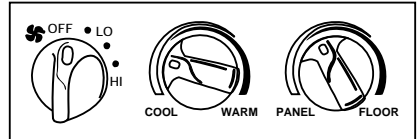

When the auxiliary air conditioning control is set to FLOOR, airflow only occurs from the third row seat floor vent located in the driver's side rear quarter trim panel.

When the auxiliary air conditioning control is set to PANEL, airflow occurs from the instrument panel vents.

Turn the fan speed control knob to the desired speed.

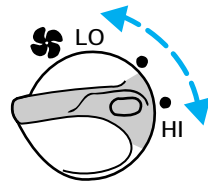
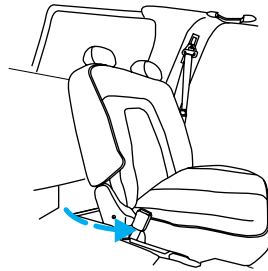

Controls and features

Turn the temperature control to the desired temperature.

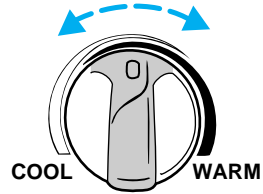

Turn the mode control to the desired airflow position:

- Far left for airflow to the overhead panel registers.
- Far right for airflow to the rear floor vent.
- Anywhere between PANEL and FLOOR to vary airflow between the outlets.

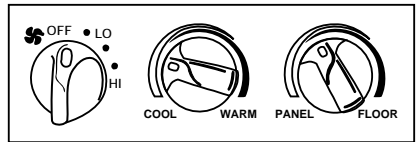

Rear console climate controls (if equipped)

Depending on the equipment package of your vehicle, the rear console may not be equipped with rear console audio/climate controls.

Turn the air distribution control to the desired airflow position.

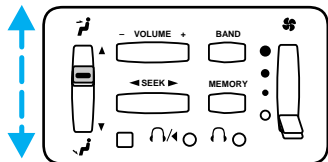

Controls and features

Turn the fan speed dial to the desired position.

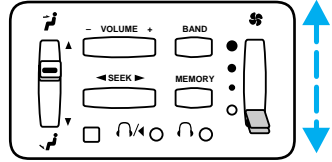

Select  for air to flow through these vents:

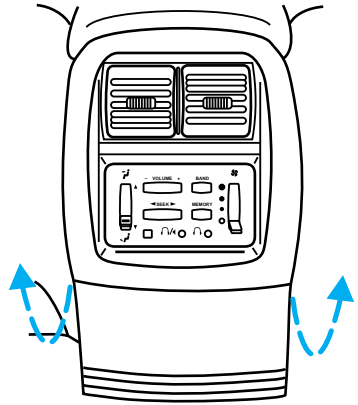

Controls and features

Select  for air to flow through these vents:

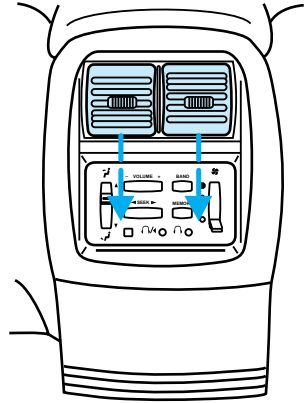

Controls and features

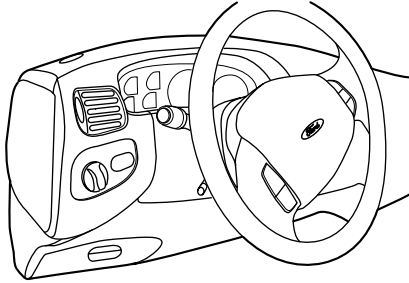

Positions of the ignition switch

1 (Accessory) — allows electrical accessories such as the audio system and wiper/washer to operate when the engine is not running.

2 (Lock) — locks the steering wheel and automatic gearshift lever.

3 (Off) — shuts off the engine and all accessories without locking the steering wheel.

4 (On) — tests the warning lights. Key remains here when engine is running.

5 (Start) — cranks the engine. Key returns to 4 (On) when released.

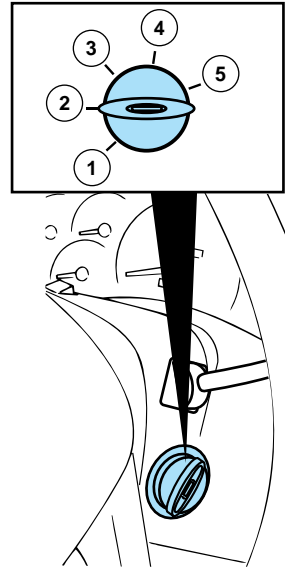

Speed control (if equipped)

To turn speed control on

- Press ON

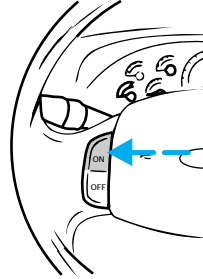

To turn speed control off

- Press OFF or
- Turn off the vehicle ignition.

Once speed control is switched off, the previously programmed set speed will be erased.

To set a speed

Press SET ACCEL. For speed control to operate, the speed control must be ON and the vehicle speed must be greater than 48 km/h (30 mph).

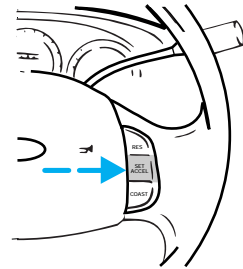

If you drive up or down a steep hill, your vehicle speed may vary momentarily slower or faster than the set speed. This is normal.

Speed control cannot reduce the vehicle speed if it increases above the set speed on a downhill. If

Controls and features

your vehicle speed is faster than the set speed while driving on a downhill in Overdrive, you may want to shift to the next lower gear to reduce your vehicle speed.

If your vehicle slows down more than 16 km/h (10 mph) below your set speed on an uphill, your speed control will disengage. This is normal. Pressing RES will re-engage it.



Do not use the speed control in heavy traffic or on roads that are winding, slippery, or unpaved.

To set a higher speed

- Press and hold SET ACCEL. Release the switch when the desired vehicle speed is reached, or
- Press and release SET ACCEL. Each press will increase the set speed by 1.6 km/h (1 mph) or
- Accelerate with your accelerator pedal, then press SET ACCEL.

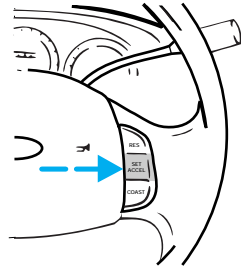

You may accelerate with the accelerator pedal at any time during speed control usage. Releasing the accelerator pedal will return your vehicle speed to the previously programmed set speed.

To set a lower set speed

- Press and hold COAST. Release the switch when the desired vehicle speed is reached, or
- Press and release COAST. Each press will decrease the set speed by 1.6 km/h (1 mph) or
- Depress the brake pedal. When the desired vehicle speed is reached press SET ACCEL.

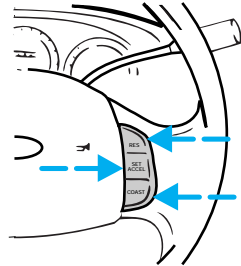

To return to a set speed

- Press RES. For RES to operate, the vehicle speed must be faster than 48 km/h (30 mph).

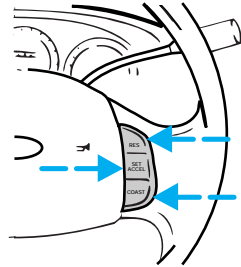

To disengage speed control

- Depress the brake pedal.
- Disengaging the speed control will not erase the previously programmed set speed.

Controls and features

Front windshield wiper/washer controls

Front wipers

Rotate the windshield wiper control to the desired interval, low or high speed position.

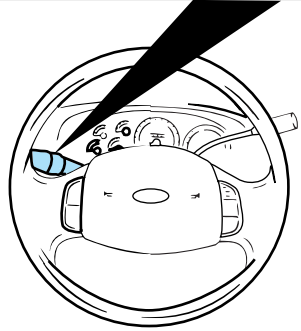
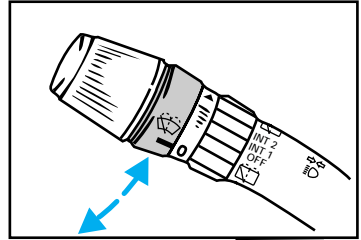

Controls and features

Front washer

For front window washer fluid operation, push (and hold as desired) the front washer control on the end of the stalk.

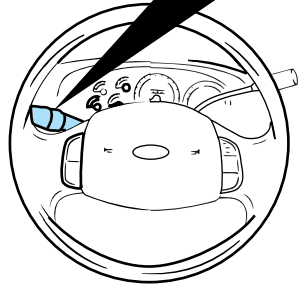
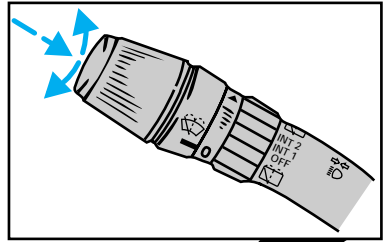

Controls and features

Rear window wiper/washer controls

Rear washer

Rotate (and hold as desired) the rear wiper/washer control to either  position.

From either position, the control will automatically return to the INT2 or OFF position.

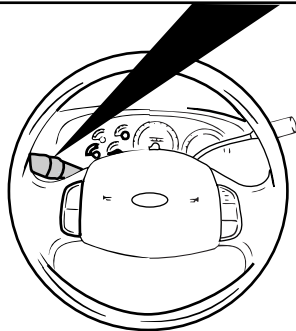
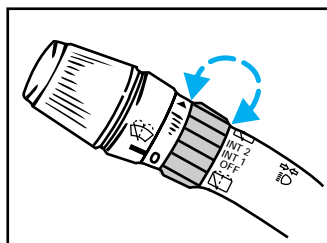

Rear wipers

For rear wiper operation, rotate the rear window wiper and washer control to the desired position.

Select:

INT 2 — One second interval rear wiper.

INT 1 — Ten second interval rear wiper.

OFF — Rear wiper and washer off.

Controls and features

Flash to pass

Pull the stalk towards you to activate the “flash to pass” function.

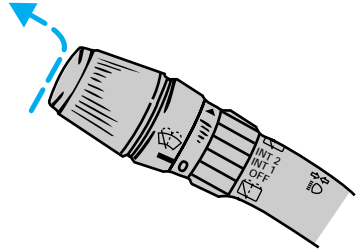

Turn signals

Push the stalk down to activate the left turn signal; push the stalk up to activate the right turn signal.



Controls and features

Overdrive control

Activating overdrive

Ⓧ (Overdrive) is the normal drive position for the best fuel economy.

The overdrive function allows automatic upshifts to second, third and fourth gear.

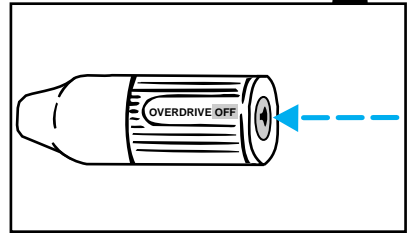
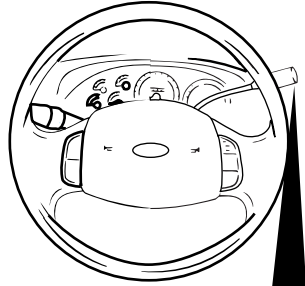

Deactivating overdrive

Press the transmission control switch on the end of the gearshift lever. The transmission control indicator light (TCIL) (OFF) will illuminate on the end of the gearshift lever.

Transmission will operate in gears one through three. To return to normal overdrive mode, press the transmission control switch again. The TCIL (OFF) will no longer be illuminated.

When you shut off and re-start your vehicle, the transmission will

automatically return to normal
Ⓧ (Overdrive) mode.

Deactivate overdrive whenever driving conditions (i.e., city traffic, hilly terrain, etc.) cause the transmission to shift excessively between Ⓧ (Overdrive) and D(Drive) ranges. Also deactivate Ⓧ (Overdrive) when:

- driving with a heavy load
- towing a trailer up or down steep hills
- additional engine braking is desired

Transmission control indicator light (TCIL)

The TCIL (OFF), located on the end of the gearshift lever, may flash steadily if a malfunction has been detected. If the TCIL is flashing, contact your Ford or Lincoln/Mercury dealer as soon as possible. If this condition persists, damage to the transmission could occur.

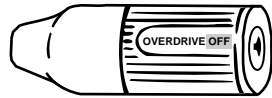

Hazard flasher control

Use only in an emergency to warn traffic of vehicle breakdown, approaching danger, etc. Depress control to activate all indicators simultaneously. Depress control again to turn off. The hazard lights can be operated when the ignition is off.

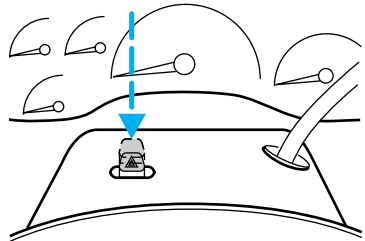

Controls and features

Tilt steering

Pull the lever to adjust the steering column angle. Push the lever back up to lock the steering wheel into position.



Never adjust the steering wheel when the vehicle is moving.

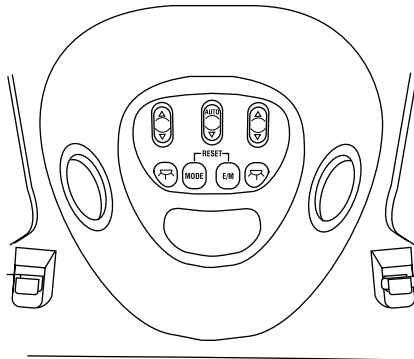
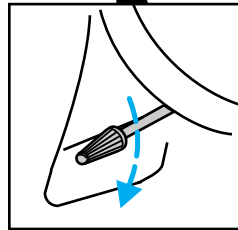
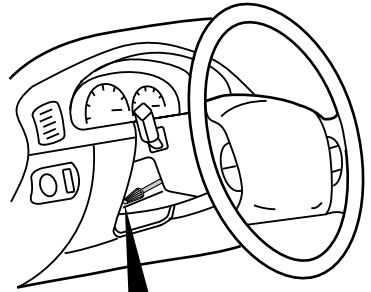

Controls and features

The front overhead console and overhead controls provide a variety of available features including:

- compass display
- trip computer
- overhead lamps
- storage compartment
- garage door opener stowage
- moon roof control
- auxiliary A/C controls
- power quarter window switches

The appearance of your vehicle's overhead console will vary according to your option package.

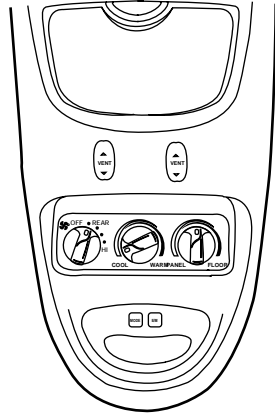

Compass display (if equipped)

The compass reading may be affected when you drive near large buildings, bridges, power lines and powerful broadcast antenna. Magnetic or metallic objects placed in or on the vehicle may also affect compass accuracy. Adjustments may be made to the zone and calibration of the compass.



Controls and features

Compass zone adjustment

1. Determine which time zone you are in by referring to the zone map.

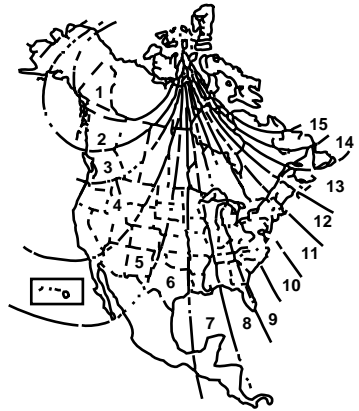

2. Locate compass sensor mounted at base of mirror.

3. Turn ignition to the On position.

4. Insert a paperclip into the small hole on the bottom of the compass sensor. Hold down until ZONE appears in the trip computer display.

5. Release pressure on the paperclip and then slowly press it down again.

6. Continue to press until your zone is shown in the trip computer display and release.

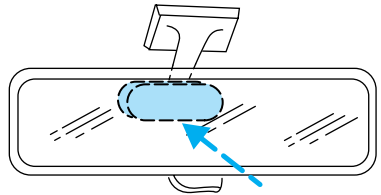

Compass calibration adjustment

Perform this adjustment in an open area free from steel structures and high voltage lines.

For optimum calibration, turn off all electrical accessories and make sure that all vehicle doors are shut.

Controls and features

1. Start the vehicle.
2. Locate compass sensor mounted at base of mirror.
3. Insert a paperclip into the small hole on the bottom of the compass sensor. Hold down until ZONE appears in the trip computer display. Continue to hold down until ZONE disappears and CAL is displayed.
4. Press and hold the MODE control until CAL appears in the display (approximately eight seconds) and release.
5. Drive the vehicle slowly (less than 5 km/h [3 mph] in circles until CAL indicator turns off (4-5 complete circles).
6. The compass is now calibrated.

Trip computer (if equipped)

This component displays a variety of system displays. The appearance of the component in the overhead console may vary according to your vehicle's equipment package.

For more information on the operation and functions of the trip computer, refer to *Trip computer* in the *Instrumentation* chapter.

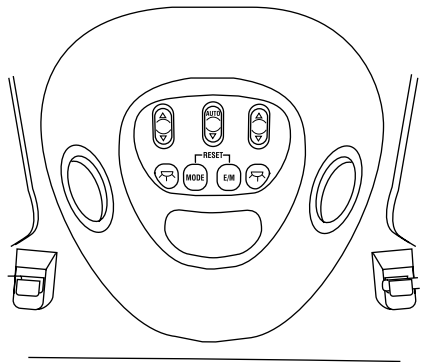

Controls and features

Overhead lamps

Map lamps (if equipped)

Press the left or right control to turn the lamp on.

Press again to turn the lamp off.

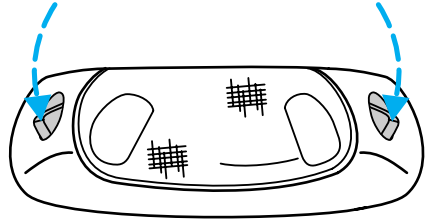

Courtesy lamps (if equipped)

Press the right portion of the lamp control to turn on.

Press the left portion of the control to turn off.

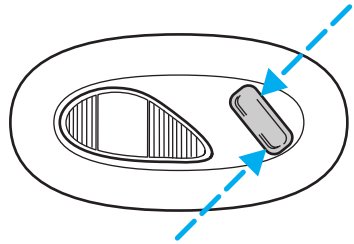

Illuminated entry system

The interior lamps and running board lights (if equipped) illuminate when:

- the remote entry system is used to unlock the door or sound the personal alarm.

The system automatically turns off after 25 seconds or when the ignition is turned to the START or ACC position.

The inside lights will not turn off if:

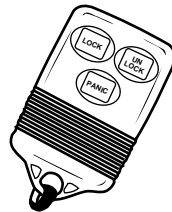

- they have been turned on with the dimmer control or
- any door is open.

Forward storage bin (if equipped)

Press the release control to open the storage compartment. The door will open slightly and can be moved to full open.

The storage compartment may be used to secure sunglasses or a like object.

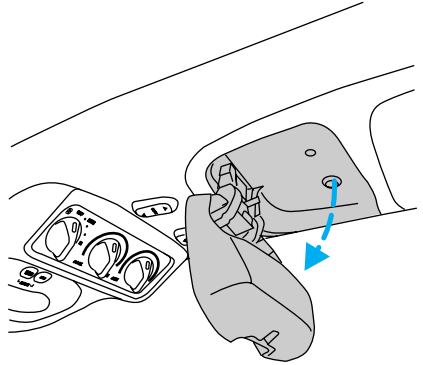

Installing a garage door opener (if equipped)

The storage compartment can be converted to accommodate a variety of aftermarket garage door openers:

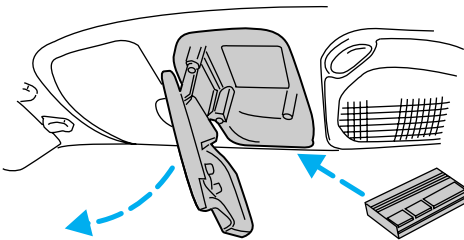

Controls and features

- Place Velcro[™] hook onto back side of aftermarket transmitter opposite of actuator control.
- Place transmitter into storage compartment, control down.
- Place the provided height adaptors onto the back of the storage bin door as needed.
- Press the storage compartment door to activate the transmitter.

One-touch moon roof (if equipped)

- Press and release the rear portion of the moon roof control to open.
- Press and hold (as desired) the front portion of the moon roof control to close.
- To halt motion at any point during one-touch opening, press the control a second time.
- The moon roof has a sliding shade that can be manually opened or closed when the glass panel is shut.
- To close the shade, pull it toward the front of the vehicle.

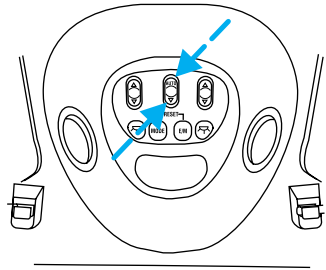

Do not let children play with the moon roof. They may seriously hurt themselves.

Controls and features

Power quarter rear windows (if equipped)

Press the ▲ portion of the VENT control to open the power rear quarter windows.

Press the ▼ portion of the VENT control to close the power rear quarter windows.

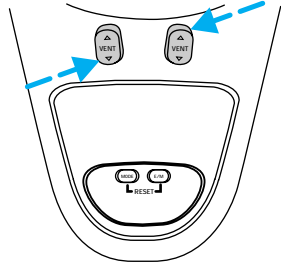

Controls and features

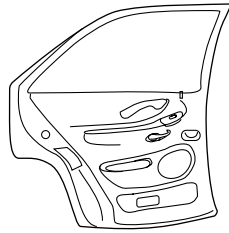
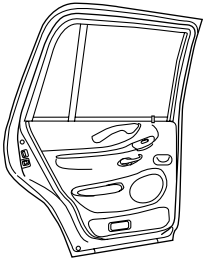

Power windows

Driver—side window control

- Press rear of switch to open window.
- Press front of switch to close window.

The driver—side power window has a one-touch down feature. When AUTO is fully pressed and released (two clicks will be heard), the driver-side window will move completely down. This feature can be cancelled by pressing the driver-side power window switch again.

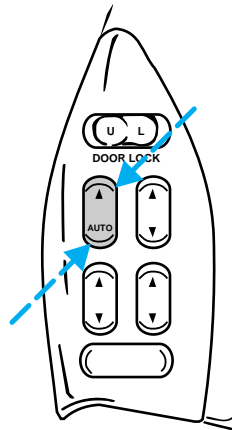

Passenger-side window controls

- Press rear of switches to open passenger window.
- Press front of switches to close passenger window.

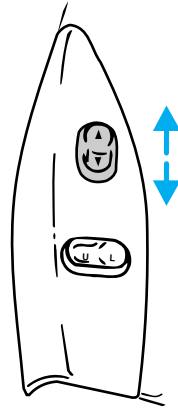

Accessory delay

With accessory delay, the window switches may be used for up to ten minutes after the ignition switch is turned to the Off position or until either door is opened.

Controls and features

Power door locks

Driver and passenger controls

- Press L to lock all doors.
- Press U to unlock all doors.

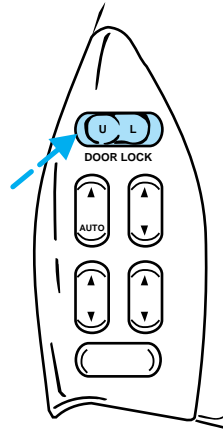

Childproof locks

The rear doors can be set to prevent children from opening the doors from the inside.

The childproof locks must be set separately for each door. Setting the lock for one door will not automatically set the lock for both rear doors.

To return the rear doors to normal operation, return the lever to the lower position.

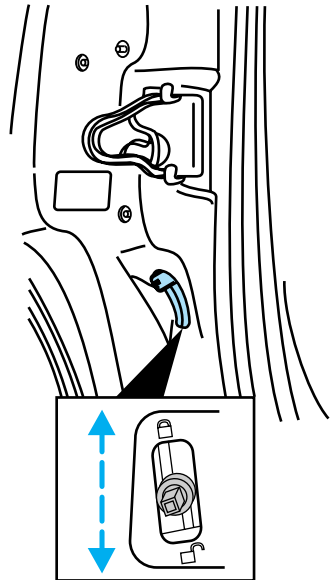

Power mirrors

To adjust the power outside mirrors:

1. Select the mirror you want to adjust:

L Driver side mirror

R Passenger side mirror

2. Move the mirror control in the desired direction.

3. Lock the mirror by moving the control to the center position.

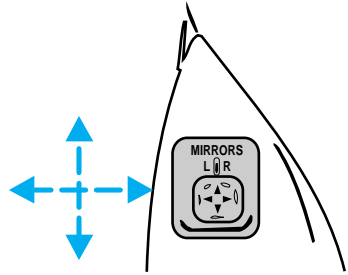

Heated outside mirrors (if equipped)

Both mirrors are heated automatically to remove ice, mist and fog when the rear window defrost is activated.

Do not remove ice from the mirrors with a scraper or attempt to readjust the mirror glass if it is frozen in place. These actions could cause damage to the glass and mirrors.

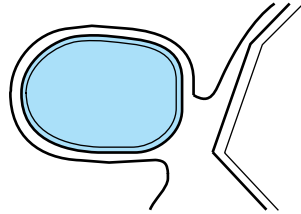

Signal mirrors (if equipped)

If your vehicle is equipped with signal mirrors, the word "signal" is located at the top of the right and left side view mirrors.

When the turn signal is activated, the appropriate mirror will show a blinking red arrow.

The arrow provides an additional warning to other drivers that your vehicle is about to turn. Driver and passengers seated inside the vehicle cannot see the arrow.

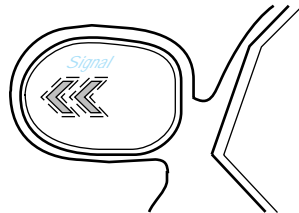

Controls and features

Rear liftgate

To open the rear window, turn the liftgate handle to the right.

To open the liftgate, turn the liftgate handle to the left.

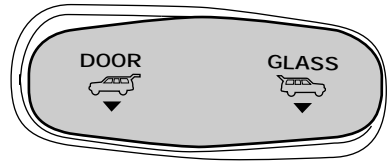

- Do not open the liftgate or liftgate glass in a garage or other enclosed area with a low ceiling. If the liftgate glass is raised and the liftgate is also opened, both liftgate and glass could be damaged against a low ceiling.
- Do not leave the liftgate or liftgate glass open while driving. Doing so could cause serious damage to the liftgate and its components as well as allowing carbon monoxide to enter the vehicle.

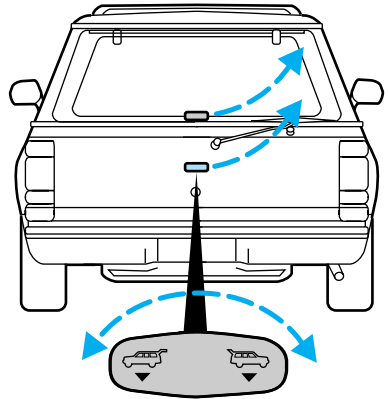

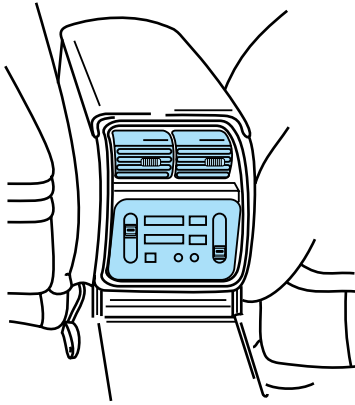

The floor console and floor console controls incorporate a variety of available features including:

- air vents
- audio system controls
- rear seat climate controls
- auxiliary power point

For information on the rear console audio system, refer to the “Audio Guide”.

Auxiliary power point

The first auxiliary power point is located on the instrument panel, next to the cigar lighter.

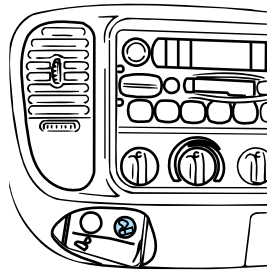

Controls and features

A second auxiliary power point is located on the left side of the rear console at the rear of the driver seat. The power point is accessible from the rear seats.

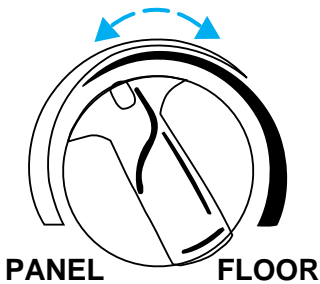
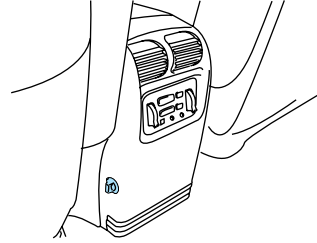

Your vehicle may be equipped with a variety of console features. These include:

- utility compartment
- cupholders
- coin holder slots
- tissue box holder
- compact disc changer



Use only soft cups in the cupholder. Hard objects can injure you in a collision.

Replacing the tissue box

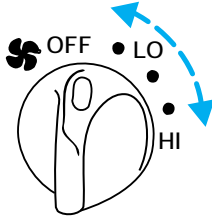

To replace the center console tissue box:

1. Lift the console door lid.
2. Slide out the empty tissue box by pulling it up and out.
3. Slide in the new tissue box.

Hooking floor mat

Installing the floor mats

1. Move the driver's seat to the most rearward position.
2. Position the driver's side floor mat with the rear of the mat against left (outboard) front edge of seat track mounting bracket.
3. To re-install mat, align grommet in mat over the locator post and snap mat into place.

Controls and features

Removing the floor mat

1. To remove mat, pull up on rear of mat to release from locator post.

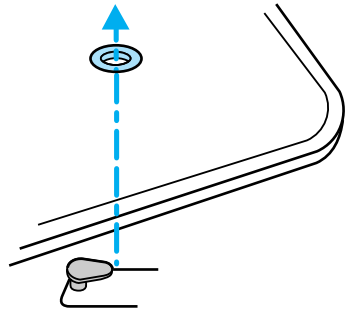

Compact disc changer (if equipped)

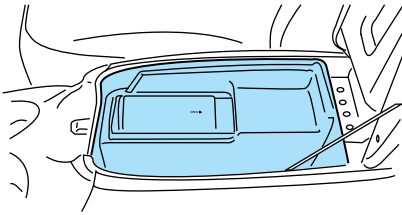

The compact disc changer is located inside the center console.

For information on the compact disc changer, refer to the “Audio Guide”.

SPARE TIRE AND JACK

Your vehicle is equipped with a jack and a full-size spare tire (if equipped). For instructions on how to remove and mount the spare tire, refer to the *Roadside emergencies* chapter.

ANTI-THEFT SYSTEM

Passive anti-theft system

Your ignition key has a unique imbedded transponder which engages engine electronics and allows the vehicle to be started. Without the use of your special ignition key, the vehicle will not start.

During each vehicle start, the coded key is read by the anti-theft system. If the key's ID code matches the code in the anti-theft system, the vehicle is enabled to start.

Your vehicle is equipped with two electronically coded keys. Additional spare keys can be purchased through your dealer or selected retailers. Be sure to purchase coded keys with the Ford logo to ensure proper functionality. If both supplied keys are lost or stolen, the vehicle and any other keys must be reinitialized by the dealer.

A theft indicator in the instrument cluster provides operating status of the anti-theft system. For more information on this indicator and its function, refer to *Warning and indicator lights* in the *Instrumentation* chapter.

Programming spare keys

Use one of the two electronically coded keys supplied with your vehicle to program additional keys:

THEFT

Controls and features

- Insert a coded key into the ignition and turn to the On position.
- Wait until the THEFT light in the instrument cluster illuminates and then turns off.
- Within 15 seconds, insert a new key into the ignition and turn the ignition to On or Start. The vehicle does not have to be started to program the key.

If the key has been coded properly, the theft indicator will illuminate for two seconds. The newly coded key can then be used to start the vehicle. This process may be repeated to code up to 16 keys.

If the key has not been coded properly, the theft indicator will flash and the vehicle cannot be started. There are several possible explanations:

- The new key was not inserted within 15 seconds.
- All 16 key codes have already been stored.
- The key does not have an electronic code.

REMOTE ENTRY SYSTEM (IF EQUIPPED)

The remote entry system allows you to lock or unlock all vehicle doors without a key.

Unlocking the doors

Press UNLOCK to unlock the driver door. The interior lamps will illuminate.

Press UNLOCK a second time within five seconds to unlock all doors.

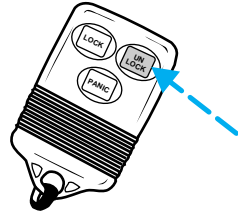

Locking the doors

Press LOCK to lock all doors.

To confirm that all doors are closed and locked, press the LOCK control a second time. The doors will lock again, the horn will chirp and the lights will flash.

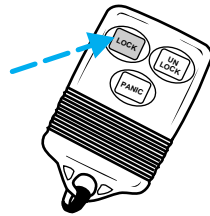

Sounding a panic alarm

Press the PANIC control to activate the alarm.

To deactivate the alarm, press the PANIC control again or turn the ignition to the Accessory or On position.

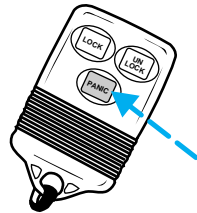

Controls and features

Replacing the batteries

The transmitter is powered by two coin type three-volt lithium batteries. A decrease in operating range can be caused by:

- battery failure
- weather conditions
- structures around the vehicle

To replace the batteries:

1. Twist a thin coin between the two halves of the transmitter. **DO NOT TAKE THE FRONT PART OF THE TRANSMITTER APART.**
2. Place the positive (+) side of new batteries down.
3. Snap the two halves back together.

Replacing lost transmitters

Take all your vehicle's transmitters to your dealer for reprogramming if:

- a transmitter is lost or
- you want to purchase additional transmitters (up to four may be programmed).

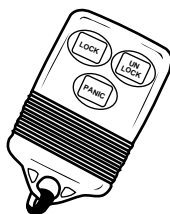

Additional information about remote entry and anti-theft systems

This device complies with Part 15 of the FCC rules. Operation is subject to the two following conditions: (1) The device may not

cause harmful interference, and (2) This device must accept any interference received, including interference that may cause undesired operation.

Replacement batteries for the remote entry transmitters may be purchased at pharmacies, watch stores or at authorized dealers.

If a transmitter is lost, a new one may be programmed by your dealer. Take the remaining transmitters with you so that they may be reprogrammed.

The system will work with up to four transmitters. Your vehicle comes equipped with two transmitters; additional transmitters can be ordered from your dealer. It will be necessary to have all transmitters programmed to the remote entry system by the dealer at the same time.

Seating and safety restraints

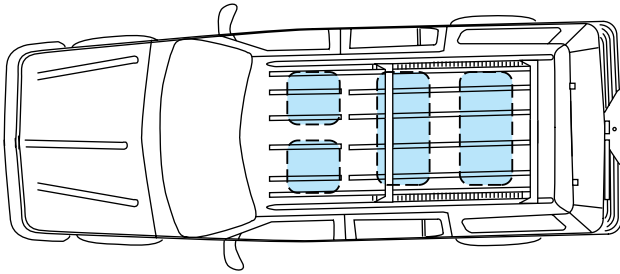

FRONT SEATS

Manually adjusting the front seats

Split bench seats (if equipped)

Lift the lever on the door side of the cushion to recline the seat.

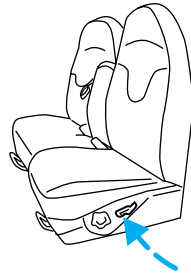

Lift the bar in front of the seat cushion to move the seat forward or backward.

Turn the lumbar support dial to adjust firmness.

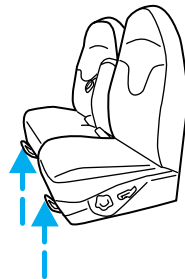

Seating and safety restraints

Using the armrest (if equipped)

Pull the strap to move the armrest down.

To move the armrest up, lift until it latches in the upright position.

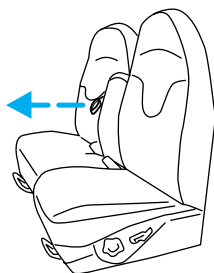

Manually adjusting the captain's chair (if equipped)

Lift the bar on the front of the seat, then move the seat forward or backward.

Lift the lever on the door side of the cushion to recline the seat.

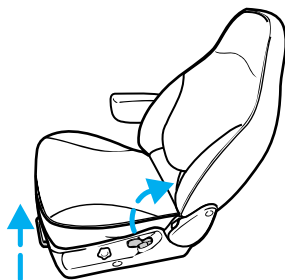

Using the manual lumbar support (if equipped)

Turn the lumbar support control counterclockwise to adjust firmness.

Turn the lumbar support control clockwise to adjust softness.

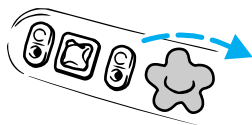

Seating and safety restraints

Adjusting the power driver's front seat (if equipped)

Adjusting the power captain's chair (if equipped)

Press to raise or lower the front portion of the seat cushion.

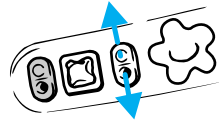

Press to raise or lower the rear portion of the seat cushion.

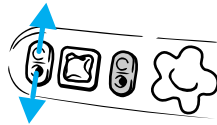

Press the control to move the seat forward, backward, up or down.

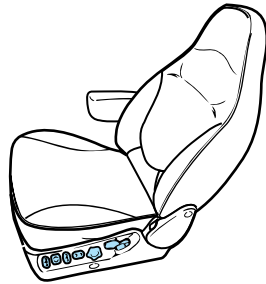

REAR SEATS

Rear seat head rests

Push or pull the head rests to the desired position.

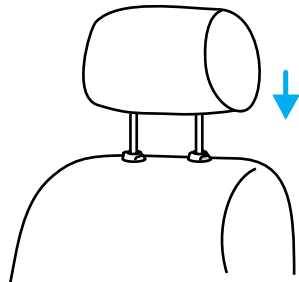

Seating and safety restraints

Rear fold seat (if equipped)

Folding down the rear seats

Insure that no objects such as books, purses or briefcases are on the floor in front of the second row seats before actuating them down.

Move front passengers seat forward so that the second row seat headrest clears the front seat.

For assistance, refer to the label located on the lower position of the opening.

1. Locate handle below the seat cushion near the bottom of the door side cushion. (If equipped with a third row seat, this handle is marked "A".)
2. Lift the handle and push the seat back toward the front of the vehicle.
3. Press the green control on the seat back to release the closeout panel. Rotate the panel to closeout the space in the floor.
4. Once the second row seats are in the down position, the front seats may be readjusted.

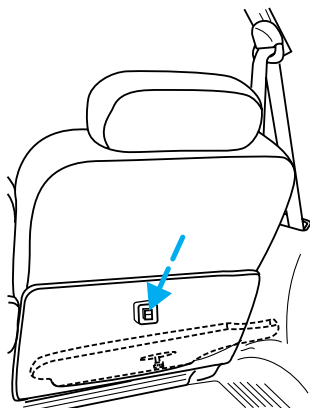

Returning the seat to upright

1. Rotate the closeout panel onto the seatback and press black control (adjacent to the green control) to lock.
2. Locate and lift handle. (If equipped with a third row seat, this handle is marked "A".)

Seating and safety restraints

3. Pull on the seatback while lifting the handle to lift the seat into the upright position.

The levers mounted to your second row seats have multiple functions which, if the seat levers are used while the vehicle is in motion, could cause a condition where the seat is not properly latched. This condition could cause serious injuries in a collision.

Third rear seat (if equipped)

The third rear seat is equipped with combination lap and shoulder belts in the outboard seating positions and a manual adjust tongue lap belt in the center seating position. For more information on the proper operation of these and other safety restraints, refer to *Using safety restraints properly* in this chapter.

The third rear seat may be removed from the vehicle for additional cargo space.

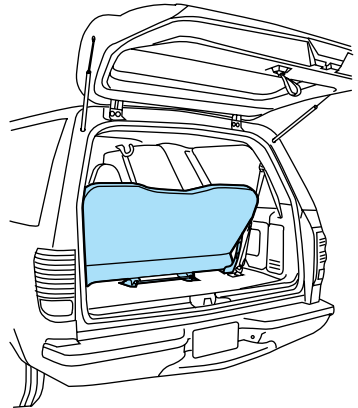

Entering the third row seat

Your vehicle is equipped with an EZ entry feature to allow ready access to the third row seat. You may enter the third row seat through the passenger side rear door. Ensure that the first row passenger seat is in the upright position in order to achieve optimum access to the third row.

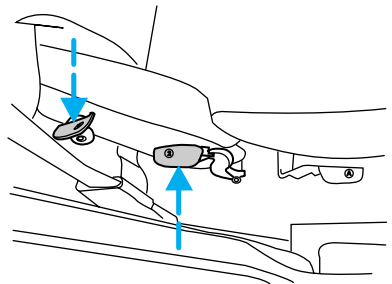

Seating and safety restraints

To minimize the risk of personal injury, the EZ entry seat should not be left in the forward, stowed position while the vehicle is in motion. Please ensure that the seat is in the upright, fully latched position before putting the vehicle in motion.

1. Locate the lever at the bottom of the passenger side seatback marked "1".
2. Press down on the front of lever "1" while pressing the seatback down onto the cushion.
3. Locate and lift the lever marked "2" while rotating the seat toward the front row seat.
4. After entering the seat, reverse this procedure; ensure that the latch tub and surrounding areas are clear.

Removing the third row seat

From the rear of the vehicle, with the liftgate open:

1. Disengage the lap/shoulder belt from the floor by pressing a key down the slot of the detachable buckle.

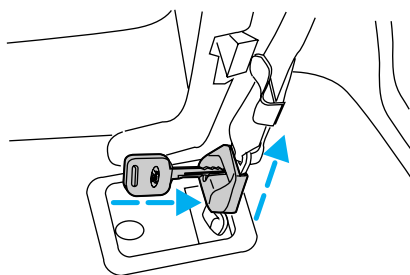

Seating and safety restraints

2. Before removing the seat, be sure that the seatbelt anchor is stowed flat into the vehicle floor.

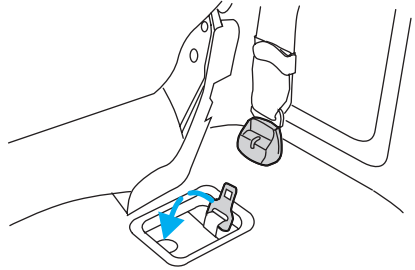

3. Use the black plastic clip (located just above the buckle) to stow the loose seat belt up at the top, near of the shoulder belt take off point.

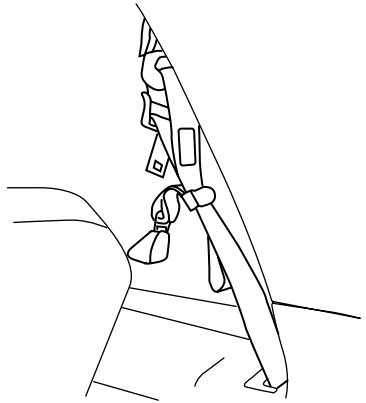

- Pull the seat release lever located on the lower right side of the seatback while pushing the seatback down into the seat cushion.
 - The seatback will latch onto the cushion.
4. Lift the seat release bar located at the center of the seat near the floor to release the floor latches.
5. While pulling up on the release bar, lift the seat up and out of the floor tubs.

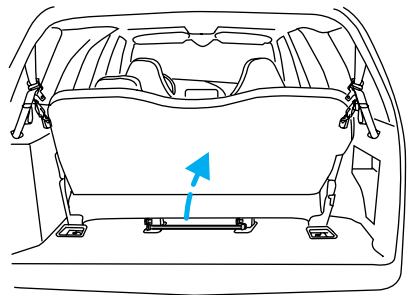

Seating and safety restraints

6. With assistance, lift the seat out of the vehicle.

Installing the third row seat

Before installing your third row seat, ensure that the seat belt anchors are stowed into the floor and the loose belts are stored out of the way. For proper latching, ensure that the floor tubs are clear of debris.

From the rear of the vehicle, with the liftgate open:

1. With assistance, lift the seat into the rear of the vehicle and guide the seat positioners over the front pins of the floor tubs.

2. Guide the positioners around each pin and lower the seat down.

- When the rear of the seat is 10–13 cm (4–5 in) above the rear pins, let the seat drop. This will insure that the seat will properly latch into the floor.

3. Locate the seat belt tongue in the plastic housing on the floor.

- Disconnect the buckle from its stowage location and connect it to the tongue (making sure that the label on the buckle is pointing toward the outside of the vehicle (left side) and that the belts are not twisted or jammed).
- Insert the seat buckle into detachable anchor until you hear a “click” and feel the latch engage.

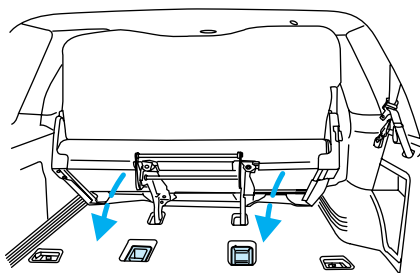

Seating and safety restraints

4. Push up on the seat to verify that it is latched into the floor.
5. Verify that the safety belts can move freely on either side of the seat.

SAFETY RESTRAINTS PRECAUTIONS

The use of safety belts helps to restrain both driver and passengers in case of a collision. Most states and in Canada, the law requires the use of safety belts.



Always drive and ride with your seatback upright and the lap belt snug and low across the hips.



All occupants of the vehicle, including the driver, should always wear their safety belts, even when an air bag Supplemental Restraint System is provided.



To prevent the risk of injury, make sure children sit where they can be properly restrained.

Seating and safety restraints



It is extremely dangerous to ride in a cargo area, inside or outside of a vehicle. In a collision, people riding in these areas are more likely to be seriously injured or killed. Do not allow people to ride in any area of your vehicle that is not equipped with seats and safety belts. Be sure everyone in your vehicle is in a seat and using a safety belt properly.

USING SAFETY RESTRAINTS PROPERLY

Combination lap and shoulder belts

Insert the tongue into the slot in the buckle to fasten.

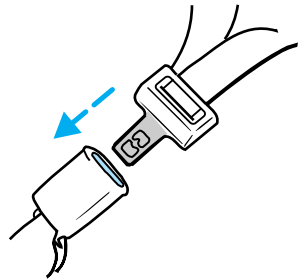

Push the red release button and remove the tongue from the slot to unfasten.

The outboard safety restraints in the vehicle are combination lap and shoulder belts. The front passenger and rear seat passenger outboard safety belts have two types of locking modes.

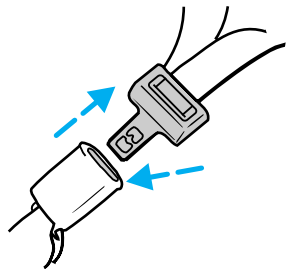

Seating and safety restraints

Vehicle sensitive (emergency) locking mode

The vehicle sensitive mode is the normal retractor mode which locks the belts in response to vehicle movement. For example, if the driver brakes suddenly or turns a corner sharply or if the vehicle receives an impact of approximately 8 km/h (5 mph) or more, the combination safety belts will lock to help reduce the forward movement of the driver and passengers.

The retractor can be made to lock by pulling on the belt.

Automatic locking mode

In this mode, the shoulder belt is automatically prelocked; however, the belt will retract to remove any slack in the shoulder belt.

The automatic locking mode is not available on the driver shoulder belt.

When to use the automatic locking mode

- When a tight lap and shoulder belt fit is desired.
- **Any time** a child safety seat is installed in the vehicle. For information on the proper use of a child safety seat, refer to *Child safety seats* later in this chapter.

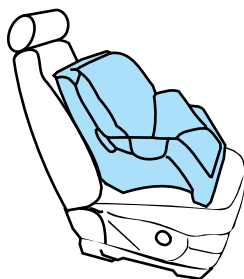

Seating and safety restraints

Using automatic locking mode

The automatic locking mode must be used when installing a child safety seat in any outboard passenger seat.

1. Buckle the combination lap and shoulder belt.
2. Grasp the shoulder belt portion and pull downward until the entire belt is extracted.
3. Allow the belt to retract. As the belt retracts, you will hear a clicking sound. This indicates that the safety belt is now in the automatic locking mode.

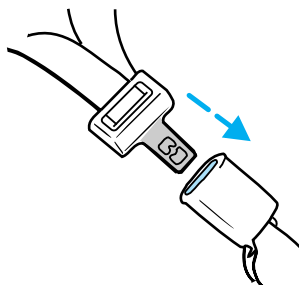

Canceling automatic locking mode

Disconnect the combination lap and shoulder belt and allow it to completely retract. This will cancel the automatic locking mode and activate the vehicle sensitive (emergency) locking mode.



Adjusting the lap belt

A lap belt is located in the center of the rear seat and third row seat (if equipped).

Because the lap belt does not have a retractor to automatically adjust itself during vehicle movement, the lap belt must be adjusted before use.

Seating and safety restraints

To shorten the belt:

- Buckle the belt.
- Pull the loose end of the belt until snug.

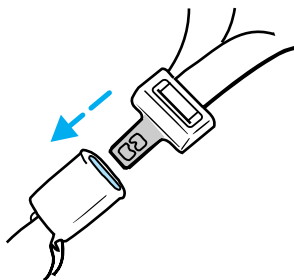

To lengthen the belt:

- Tip and pull the tongue.

Do not wear the lap belt around your waist, keep it low around your hips.

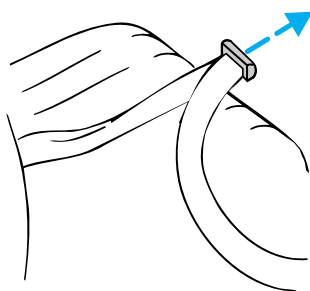

Front seat safety belt height adjustment

Adjust the height of the shoulder belt so that the belt rests across the middle of your shoulder.

To lower the height of the shoulder belt:

- Push the button down.
- Slide down.

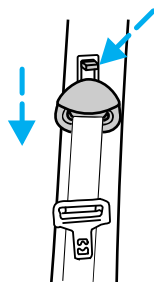

Seating and safety restraints

To raise the height of the shoulder belt:

- Slide up.
- Pull down on the height adjuster to make sure that it is locked in place.

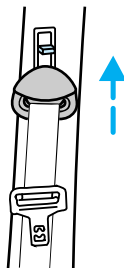

Safety belt maintenance

Check the safety belt systems periodically to make sure that they work properly and are not damaged. If your vehicle has been involved in an accident, have all the safety belts and child seat anchoring brackets (if equipped) examined by a qualified technician. Refer to *Cleaning and caring for your vehicle* in the *Maintenance and care* chapter for more information on maintaining your safety belts.



Failure to replace the safety belt assembly under the above conditions could result in severe personal injuries in the event of a collision.

Safety belt extension assembly

For some people, the safety belt may be too short even when it is fully extended. You can add about 20 cm (8 in.) to the belt length with a safety belt extension assembly (part # 611C22). Safety

Seating and safety restraints

belt extensions are available at no cost from your Ford or Lincoln/Mercury dealer.

Use only extensions manufactured by the same supplier as the safety belt. Manufacturer identification is located at the end of the webbing on the label. Also, use the safety belt extension only if the safety belt is too short for you when fully extended. Do not use extension to change the fit of the shoulder belt across the torso.

SAFETY BELT INDICATOR LIGHT AND WARNING CHIME

 illuminates in the instrument cluster and a chime sounds to remind the occupants to fasten their safety belts:

CONDITIONS OF OPERATION

If	Then
The driver's safety belt is not buckled before the ignition key is turned to On. .	The safety belt indicator illuminates for 1-2 minutes and the warning chime sounds for 4- 8 seconds.
The driver's safety belt is buckled while the indicator light is illuminated and the reminder chime is sounding . . .	The safety belt indicator light and reminder chime turn off.
The driver's safety belt is buckled before the ignition key is turned to On. . .	The safety belt indicator light and reminder chime remain off.

Seating and safety restraints

SUPPLEMENTAL RESTRAINT SYSTEM (SRS)

Important supplemental restraint system (SRS) precautions

The supplemental restraint system is designed to:

- work with the safety belt to protect the driver and right front passenger
- reduce certain upper body injuries



Failure to follow these instructions will affect the performance of the safety belts and increase the risk of personal injury.



The right front passenger air bag is not designed to restrain occupants in the front seating position.



Do not place objects or mount equipment on or near the air bag covers that may come into contact with an inflating air bag.

Seating and safety restraints

 Do not attempt to service, repair, or modify the Air Bag Supplemental Restraint System or its fuses. See your Ford or Lincoln-Mercury dealer.

Children and air bags

For additional important safety information, read all information on safety restraints in this guide.

Children should always wear their safety belts. Failure to follow these instructions may increase the risk of injury in a collision.

 Rear-facing child seats or infant carriers should never be placed in the front seats.

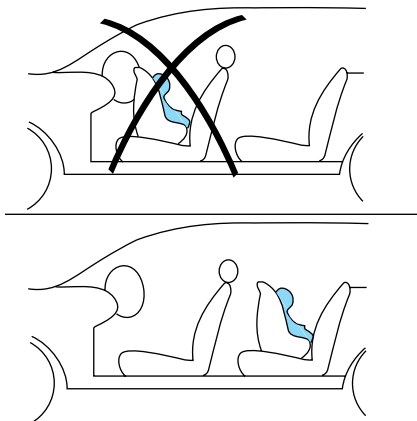

Seating and safety restraints

How does the air bag supplemental restraint system work?

The SRS is designed to activate when the vehicle sustains sufficient longitudinal deceleration, similar to hitting a fixed barrier head on at 12–24 km/h (8–14 mph).

The fact that the air bags did not inflate in a collision does not mean that something is wrong with the system. Rather, it means the forces were not of the type sufficient to cause activation.

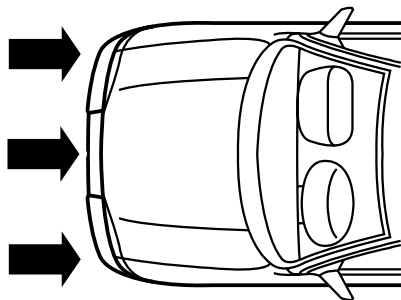

The air bags inflate and deflate rapidly upon activation.

After air bag deployment, it is normal to notice a smoke-like, powdery residue or smell the burnt propellant. This may consist of cornstarch, talcum powder (to lubricate the bag) or sodium compounds (e.g., baking soda) that result from the combustion process that inflates the air bag. Small amounts of sodium hydroxide may be present which may irritate the skin and eyes, but none of the residue is toxic.



Several air bag system components get hot after inflation. Do not touch them after inflation.

Seating and safety restraints



If the air bag is inflated, **the air bag will not function again and must be replaced immediately.** If the air bag is not replaced, the unrepaired area will increase the risk of injury in a collision.

The SRS consists of:

- driver and passenger air bag modules (which include the inflators and air bags),
- one or more impact and safing sensors,
- a readiness light and tone
- and the electrical wiring which connects the components.

The diagnostic module monitors its own internal circuits and the supplemental air bag electrical system readiness (including the impact sensors), the system wiring, the air bag system readiness light, the air bag back up power and the air bag ignitors.

Determining if the system is operational

The SRS uses a readiness light in the instrument cluster or a tone to indicate the condition of the system. Refer to the *Air bag readiness* section in the *Instrumentation* chapter. Routine maintenance of the air bag is not required.

Seating and safety restraints

A difficulty with the system is indicated by one or more of the following:

- The readiness light will either flash or stay lit.
- The readiness light will not illuminate immediately after ignition is turned on.
- A group of five beeps will be heard. The tone pattern will repeat periodically until the problem and light are repaired.



If any of these things happen, even intermittently, have the SRS serviced at your dealership or by a qualified technician immediately. Unless serviced, the system may not function properly in the event of a collision.

Disposal of air bags and air bag equipped vehicles

For disposal of air bags or air bag equipped vehicles, see your local dealership or qualified technician. Air bags **MUST BE** disposed of by qualified personnel.

SAFETY RESTRAINTS FOR CHILDREN

Important child restraint precautions

You are required by law to use safety restraints for children in the U.S. and Canada. If small children ride in your vehicle (generally children who are four years old or younger and who weigh 18 kg [40 lbs] or less), you must put them in

Seating and safety restraints

safety seats made especially for children. Check your local and state laws for specific requirements regarding the safety of children in your vehicle.



Never let a passenger hold a child on his or her lap while the vehicle is moving. The passenger cannot protect the child from injury in a collision.



Do not leave children, unreliable adults, or pets unattended in your vehicle.

Always follow the instructions and warnings that come with any infant or child restraint you might use.

If possible, place children in the rear seat of your vehicle. Accident statistics suggest that children are safer when properly restrained in rear seating positions than when they are restrained in front seating positions.

CHILDREN AND SAFETY BELTS

Children who are too large for child safety seats (as specified by your child safety seat manufacturer) should always wear safety belts.

Follow all the important safety restraint and air bag precautions that apply to adult passengers in your vehicle.

If the shoulder belt portion of a combination lap and shoulder belt

Seating and safety restraints

can be positioned so it does not cross or rest in front of the child's face or neck, the child should wear the lap and shoulder belt. Moving the child closer to the center of the vehicle may help provide a good shoulder belt fit.

If the shoulder belt cannot be properly positioned:

- move the child to one of the seats with a lap belt only (if equipped)

OR

- if the child is the proper size, restrain the child in a safety seat.



Do not leave children, unreliable adults, or pets unattended in your vehicle.

To improve the fit of lap and shoulder belts on children who have outgrown child safety seats, Ford recommends use of a belt-positioning booster seat that is labelled as conforming to all Federal motor vehicle safety standards. Belt-positioning booster seats raise the child and provide a shorter, firmer seating cushion that encourages safer seating posture and better fit of lap and shoulder belts on the child. A

belt-positioning booster should be used if the shoulder belt rests in front of the child's face or neck, or if the lap belt does not fit snugly on both thighs, or if the thighs are too short to let the child sit all the

Seating and safety restraints

way back on the seat cushion when the lower legs hang over the edge of the seat cushion. You may wish to discuss the special needs of your child with your pediatrician.

INSTALLING CHILD SAFETY SEATS IN THE REAR SEATING POSITIONS

To install a child safety seat in a center rear seating position:

1. Tip the tongue and pull to lengthen the lap belt.
2. Place the child safety seat in the center seating position.
3. Route the lap belt through the child safety seat according to the manufacturer's instructions.
4. Insert the tongue into the proper buckle.
5. Push down on the child safety seat while pulling the loose part of the belt webbing to tighten the belt.
6. Before placing the child in the safety seat, forcibly tilt the seat from side to side and forward and back to make sure that the seat is held securely in place. If the child seat moves excessively, repeat steps five and six, install a tether strap or properly install the child seat in another seating position.

Seating and safety restraints

Installing child safety seats in combination lap and shoulder belt seating positions

1. Position the child safety seat in a seat with a combination lap and shoulder belt.



If you choose to install a child safety seat in the front passenger seat, move the seat as far back as possible.



Rear-facing child seats or infant carriers should never be placed in the front seats.

2. Pull down on the shoulder belt and then grasp the shoulder belt and lap belt together.

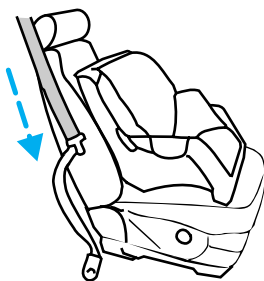

Seating and safety restraints

3. While holding the shoulder and lap belt portions together, route the tongue through the child seat according to the child seat manufacturers' instructions. Be sure the belt webbing is not twisted.

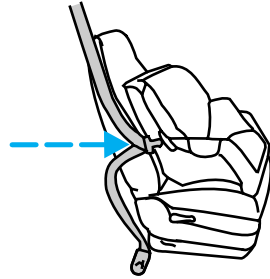

4. Insert the belt tongue into the proper buckle for that seating position until you hear and feel the latch engage. Make sure the tongue is latched securely by pulling on it.

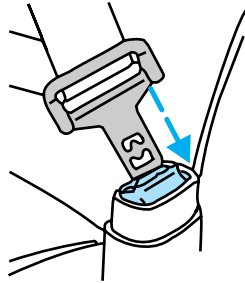

5. To put the retractor in the automatic locking mode, grasp the shoulder portion of the belt and pull downward until all of the belt is extracted and a click is heard.

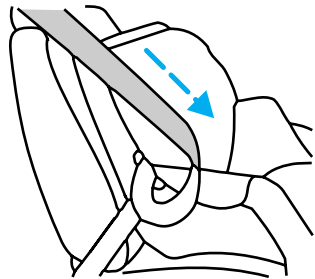

6. Allow the belt to retract. The belt will click as it retracts to indicate it is in the automatic locking mode.

Seating and safety restraints

7. Pull the lap belt portion across the child seat toward the buckle and pull up on the shoulder belt while pushing down with knee on the child seat.

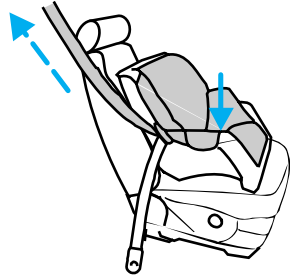

8. Allow the safety belt to retract to remove any slack in the belt.

9. Before placing the child in the seat, forcibly tilt the seat forward and back to make sure the seat is securely held in place.

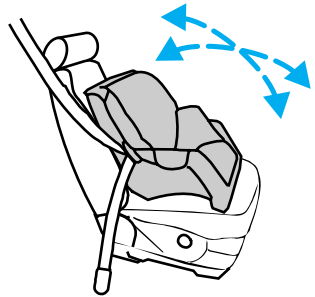

10. Try to pull the belt out of the retractor to make sure the retractor is in the automatic locking mode (you should not be able to pull more belt out). If the retractor is not locked, unbuckle the belt and repeat steps two through nine.

Check to make sure the child seat is properly secured before each use.

Seating and safety restraints

Child and infant or child safety seats



Carefully follow all of the manufacturer's instructions included with the safety seat you put in your vehicle. If you do not install and use the safety seat properly, the child may be injured in a sudden stop or collision.

Ford recommends the use of a child safety seat having a top tether strap. Install the child safety seat in a seating position which is capable of providing a tether anchorage. For more information on top tether straps see *Attaching safety seats with tether straps* in this chapter.

When installing a child safety seat:

- Use the correct safety belt buckle for that seating position.
- Make sure the tongue is securely fastened in the buckle.
- Keep the buckle release button pointing up and away from the safety seat, with the tongue between the child seat and the release button, to prevent accidental unbuckling.
- Place seatbacks in the upright position.
- Put the safety belt in the automatic locking mode. Refer to *Using the automatic locking mode* in this chapter.

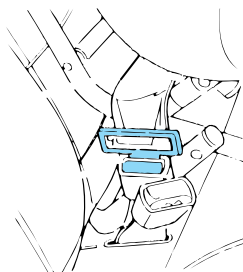

Seating and safety restraints

Using a tether strap

Ford recommends using child safety seats with a top tether strap. Contact the manufacturer of your safety seat for information about ordering a tether strap if one is not provided to you.

Ford recommends you attach tether safety seats in a rear seating position (if possible), with the tether strap attached to the tether anchor bracket.

Tether anchor brackets may also be installed to the floor behind the second row seats.

Tether anchor hardware

A tethered seat can be installed in the front seat; put the tether strap over the seatback and attach it to a anchor bracket.

A anchor bracket can be installed on the rear edge of the front seat cushion.

The provision (attaching hole) is provided in the rear edge of the front passenger seat cushion frame. The anchor bracket *must be installed using the instructions provided with the kit.*

Contact your Ford dealer for a free tether anchor kit (613D74). Carefully follow the instructions provided with the kit.

Starting

BEFORE STARTING YOUR VEHICLE

Important safety precautions

A computer system controls the engine's idle revolutions per minute (RPM). When the engine starts, the idle RPM runs faster to warm the engine. If the engine idle speed does not slow down automatically, have the vehicle checked. Do not allow the vehicle to idle for more than ten minutes.



Extended idling at high engine speeds can produce very high temperatures in the engine and exhaust system, creating the risk of fire or other damage.



Do not park, idle, or drive your vehicle in dry grass or other dry ground cover. The emission system heats up the engine compartment and exhaust system, which can start a fire.



Do not start your vehicle in a closed garage or in other enclosed areas. Exhaust fumes can be toxic. Always open the garage door before you start the engine. See *Guarding against exhaust fumes* in this chapter for more instructions.



If you smell exhaust fumes inside your vehicle, have your dealer inspect your vehicle immediately. Do not drive if you smell exhaust fumes.

Preparing to start the vehicle

Engine starting is controlled by the spark ignition system. This system meets all Canadian Interference-Causing Equipment standard requirements regulating the impulse electrical field strength of radio noise.

When starting a fuel-injected engine, avoid pressing the accelerator before or during starting. Only use the accelerator when you have difficulty starting the engine. For more information on starting the vehicle, refer to *Starting the vehicle* in this chapter.

Before starting the vehicle:

1. Make sure all vehicle occupants have buckled their safety belts. For more information on safety belts and their proper usage, refer to the *Seating and safety restraints* chapter.

Starting

2. Make sure the headlamps and vehicle accessories are off.

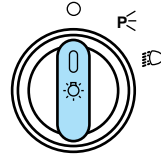

- Make sure the parking brake is set.
- Make sure the gearshift is in P (Park).

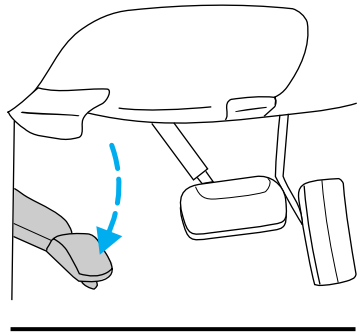

3. Turn the key to the ON position (without turning the key to START.)

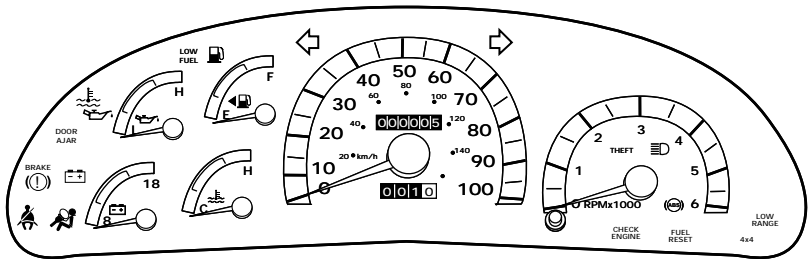

Make sure the corresponding lights illuminate briefly. If a light fails to illuminate, have the vehicle serviced.

- If the driver's safety belt icon is fastened, the  light does not illuminate.

STARTING YOUR VEHICLE

Starting the engine

1. Turn the key to 5 (Start) without pressing the accelerator. The key will return to 4 (On).

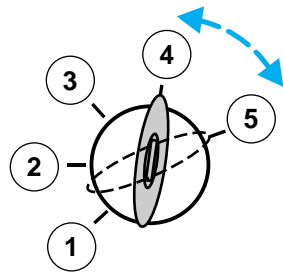

2. If the engine does not start within five seconds, wait ten seconds and try again.

3. If the engine does not start in two attempts OR the temperature

Starting

is below -12°C (10°F), depress accelerator and start the engine while holding the accelerator down. Release accelerator when engine starts.

4. After idling for a few seconds, apply the brake and release the parking brake.

Using the engine block heater (if equipped)

An engine block heater warms the engine coolant, which improves starting, warms up the engine faster and allows the heater-defroster system to respond quickly. They are strongly recommended if you live in a region where temperatures reach -23°C (-10°F) or below.

For best results, plug the heater in at least three hours before starting the vehicle. Using the heater for longer than three hours will not harm the engine, so the heater can be plugged in the night before starting the vehicle.



To prevent electrical shock, do not use your heater with ungrounded electrical systems or two-pronged (cheater) adapters.

Important ventilating information

If the engine is idling while the vehicle is stopped in an open area for long periods of time, open the windows at least 2.5 cm (one inch).

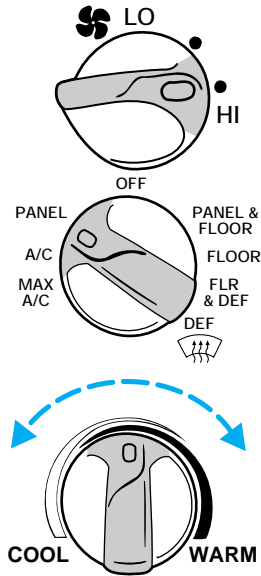

Adjust the heating or air conditioning (if equipped) to bring in fresh air.

Improve vehicle ventilation by keeping all air inlet vents clear of snow, leaves and other debris.

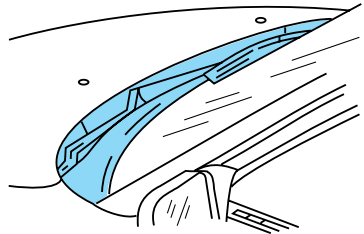

Starting

Guarding against exhaust fumes

Although odorless and colorless, carbon monoxide is present in exhaust fumes. Take precautions to avoid its dangerous effects.



If you ever smell exhaust fumes of any kind inside your vehicle, have your dealer inspect and fix your vehicle immediately. Do not drive if you smell exhaust fumes. These fumes are harmful and could kill you.

Have the exhaust and body ventilation systems checked whenever:

- the vehicle is raised for service
- the sound of the exhaust system changes
- the vehicle has been damaged in a collision

BRAKES

Brakes

Your brakes are self-adjusting. Refer to the “Service Guide” for maintenance scheduling.

Anti-lock brake system (ABS) (if equipped)

The ABS operates by detecting the onset of wheel lock up during brake applications and compensating for this tendency. The front wheels are prevented from locking even when the brakes are firmly applied. The accompanying illustration depicts the advantage of an ABS equipped vehicle (on bottom) to a non-ABS equipped vehicle (on top) during hard braking.

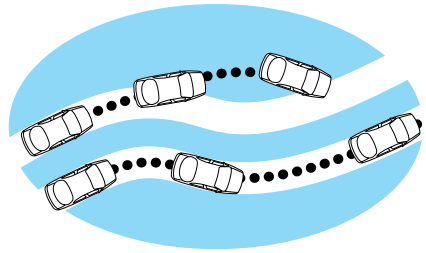

Using ABS

- In an emergency, apply full force on the brake. The ABS will be activated immediately, thus allowing you to retain full steering control of your vehicle and, providing there is sufficient space, will enable you to avoid obstacles and bring the vehicle to a quiet stop.
- We recommend that you familiarize yourself with this braking technique. However, avoid taking any unnecessary risks.

Driving

Braking with ABS

On vehicles with ABS, the wheels will not lock and slide when you press down hard on the brake pedal. The ABS automatically releases and reapplies the front and rear brakes independently whenever the wheels start to lock. When this happens, you will feel the brake pedal pulse. This pulse may be unfamiliar feeling, but it is a normal indication that the ABS is working as designed.

Do not “pump” the brake pedal of vehicles with ABS.

Parking brake

To engage the parking brake:

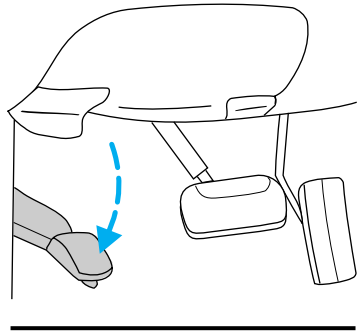

To disengage the parking brake:



Always set the parking brake fully and make sure that the gearshift is securely latched in P (Park) (automatic transmission) or in 1 (First) (manual transmission).

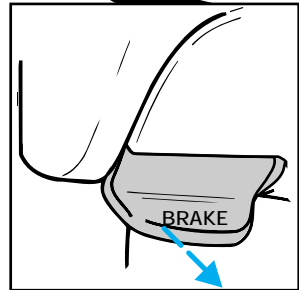
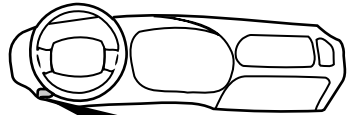

STEERING

Your vehicle is equipped with power steering. Power steering uses energy from the engine to help steer the vehicle.

Driving

Never hold the steering wheel to the extreme right or the extreme left for more than a few seconds when the engine is running. This action could damage the power steering pump.

Speed sensitive steering

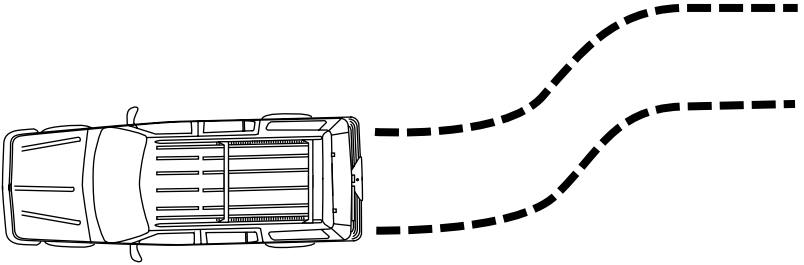

The steering in your vehicle is speed sensitive. At high speeds, steering assist will decrease to improve steering feel. At lower speeds, maneuverability will be increased.

If the amount of effort required to steer your vehicle changes at a constant vehicle speed, have the power steering system checked by your dealer or a qualified service technician.

UNDERSTANDING THE TRACTION-LOK® REAR AXLE (IF EQUIPPED)

This axle provides added traction on slippery surfaces, particularly when one or more wheels are on a surface with poor traction.

Extended use of other than matching size tires on a Traction-Lok® rear axle could result in a permanent reduction in effectiveness. This loss of effectiveness does not affect normal driving and should not be noticeable to the driver.

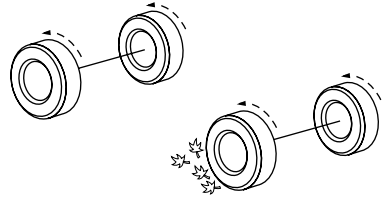

To avoid injury, never run the engine with one wheel off the ground, such as when changing a tire.

AIR SUSPENSION SYSTEM (IF EQUIPPED)

The air suspension system is designed to improve ride, handling and general vehicle performance for static, on and off road driving conditions.

The load leveling feature of the air suspension system automatically keeps the vehicle at a constant level if a load is added or removed from the vehicle.

The height adjustment feature (4x4 air suspension system only) automatically controls the vehicle height over a range of approximately 5 cm (2 in) based on vehicle speed, ignition position

Driving

and selection of two or four-wheel drive modes.

The air suspension system places the vehicle at its lowest height to provide easy entry and exit when the vehicle is parked, the ignition is turned off and all doors are closed.

The air suspension system raises the vehicle approximately 2.5 cm (1 in) to its normal ride position when the ignition is turned on, the transmission is initially shifted into the drive or reverse mode and all doors are closed.

In 4WD Low, the air suspension system raises the vehicle an additional 2.5 cm (1 in) above the normal ride height to improve vehicle ground clearance. However, if the vehicle speed exceeds 40 km/h (25 mph), the system will lower the vehicle to its normal ride height to maximize ride comfort. The vehicle will raise again if vehicle speed is less than 13 km/h (8 mph) for one minute. In 4WD Low, do not exceed 56 km/h (35 mph).

As a safety consideration, whenever a door is opened (including the liftgate and liftgate glass) the system memorizes and maintains the height at the moment the door was opened. The system will maintain this height until all doors are closed or until vehicle speed exceeds 16 km/h (10 mph).

An on board air compressor and solenoids are used to raise and lower the vehicle. It is normal to occasionally hear a buzz or clicking from the vehicle even when the ignition is turned off. The system stays energized for 40 minutes after the ignition is turned off to compensate for any load changes made after the vehicle is parked.

Air suspension service system switch

The air suspension service system switch is located below the glove box at the lower right side of the passenger foot well. Normal vehicle operation does not require any action by the driver. If this switch is in the OFF position, the air suspension system will not operate and the CHECK SUSP warning light in the instrument cluster will illuminate.

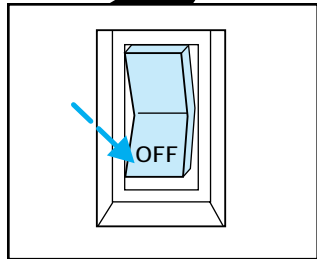
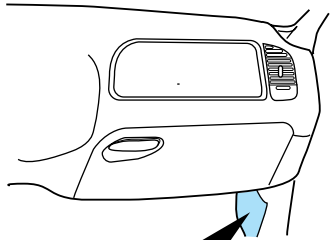

 On vehicles equipped with Air Suspension, turn OFF the Air Suspension switch prior to jacking, hoisting or towing your vehicle.

Check air suspension light

The warning and indicator light CHECK SUSP illuminates when the air suspension switch is turned off or an air suspension system fault has been detected.

**CHECK
SUSP**

Driving

If the light is displayed while driving and the air suspension system service switch is not turned off, safely pull off the road at your earliest convenience. Turn the ignition switch from 4(On) to 3(Off) and 4(On) again. If the warning light reappears, turn the air suspension switch off and have the vehicle serviced by your dealer or qualified service technician.

If the vehicle is loaded beyond the recommended maximum payload, the CHECK SUSP light may illuminate. To correct this condition, remove or redistribute the payload according to the recommended requirements and follow the procedure outlined above.

TRANSMISSION OPERATION

Automatic transmission operation



Hold the brake pedal down while you move the gearshift lever from position to position. If you do not hold the brake pedal down, your vehicle may move unexpectedly and injure someone.

Pull the gearshift lever towards you and downward to move the automatic gearshift.

P (Park) — Always come to a complete stop before shifting into or out of P (Park).



When you leave your vehicle, place the gearshift lever in P (Park). Set the parking brake fully, and shut off the engine. Never park your vehicle in N (Neutral). If you do not take these precautions, your vehicle may move suddenly and injure someone.

R (Reverse) — Always come to a complete stop before shifting into or out of R (Reverse).

N (Neutral) — Vehicle is free to roll.

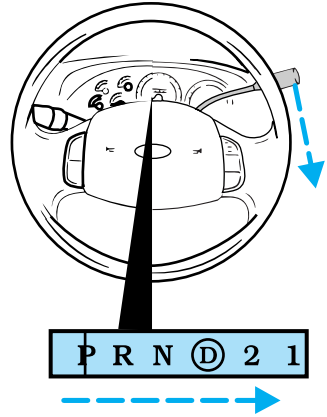

Driving

Ⓧ (**Overdrive**) — The normal driving position for the best fuel economy. Transmission operates in gears one through four.

Ⓧ (Overdrive) can be deactivated by pressing the transmission control switch on the end of the gearshift lever. The transmission control indicator light (TCIL) (OFF) on the end of the gearshift lever will remain off.

D(Drive) — Not shown on the display. Activate by pressing the transmission control switch on the end of the gearshift lever. The TCIL (OFF) will illuminate on the gearshift lever. Transmission operates in gears one through three. D(Drive) provides more engine braking than

Ⓧ (Overdrive) and is useful whenever driving conditions (i.e., city traffic, hilly terrain, etc.) cause the transmission to excessively shift between Ⓧ (Overdrive) and D(Drive). Also deactivate Ⓧ (Overdrive) when:

- driving with a heavy load
- towing a trailer up or down steep hills
- additional engine braking is desired

To return to Ⓧ (Overdrive) mode, press the transmission control switch. The TCIL (OFF) will no longer be illuminated.

Each time the vehicle is started, the transmission will automatically return to normal overdrive mode.

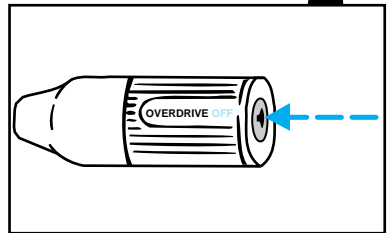
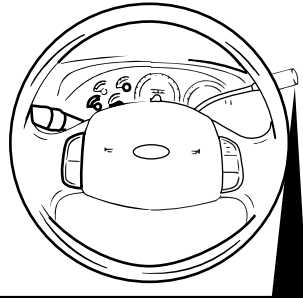

2(Second) — Use 2(Second) to start-up on slippery roads or to provide additional engine braking on downgrades. Transmission operates in first and second gears.

1(Low) — Use 1(Low) to provide maximum engine braking on steep downgrades. Upshifts can be made by shifting to 2(Second) or to **Ⓢ** (Overdrive). Selecting 1(Low) at higher speeds causes a shift to 2(Second), and will shift to 1(Low) after vehicle decelerates to the proper speed.

Brake-shift interlock

The brake-shift interlock feature prevents you from shifting from P(Park) unless the brake pedal is depressed (with the ignition in the On position). If you cannot move the gearshift out of P(Park) with the brake pedal depressed:

1. Turn ignition key to Off (3).
2. Apply the parking brake.

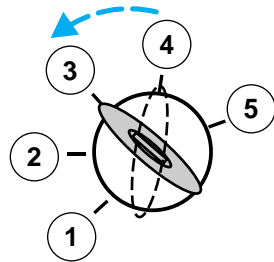

Driving

3. Turn ignition key to Lock (2) and remove the key.

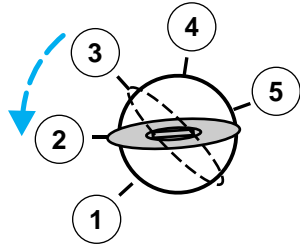

4. Re-insert the ignition key and turn it to Off (3).

5. Shift the transmission to N(Neutral).

6. Start the vehicle.

If you need to use the above procedure, it is possible that a fuse has blown and your brakelamps may not be functioning. Refer to the *Roadside emergencies* chapter for instructions on replacing fuses.



Do not drive your vehicle until you verify that the brakelamps are working.

CONTROL TRAC-AUTOMATIC FOUR-WHEEL DRIVE SYSTEM (IF EQUIPPED)

Your 4x4 features a heavy-duty Control Trac system, includes a computer-operated transfer case. Coupled with a center-disconnected front axle, this unique system is interactive with the road, continually monitoring and adjusting torque delivery to the front and rear wheels to optimize vehicle control.

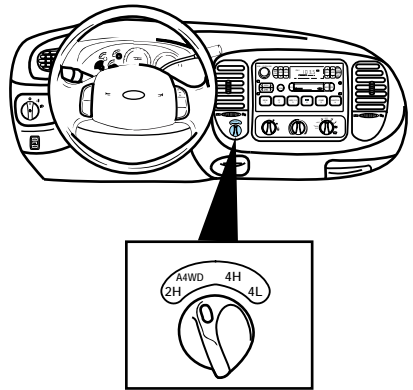

Positions of the Control Trac system

The Control Trac A4WD system functions in four modes:

- *2H* position delivers power only to the rear axle.
- *A4WD* position delivers power to the rear axle, and the front axle when road conditions dictate the need for increased traction.
- *4H* position provides mechanically locked four-wheel drive power delivery to front and rear axles.
- *4L* position provides mechanically locked four-wheel drive when above average power at reduced speeds is required.

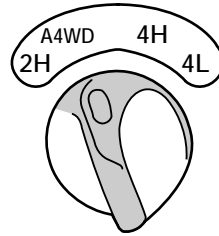

Driving



Utility and four-wheel drive vehicles are **not** designed for cornering at speeds as high as passenger cars any more than low-slung sports cars are designed to perform satisfactorily under off-road conditions. Avoid sharp turns or abrupt maneuvers in these vehicles.

Using the Control Trac system

Shifting to A4WD

Move the 4WD control to A4WD at a stop or at speeds up to 88 km/h (55 mph).

- At temperatures below 0° C (32° F), shifts from 2H to A4WD or 4H should not be performed above 72 km/h (45 mph).
- Do not shift into A4WD when only the rear wheels are spinning.

Shifting to 2H

Move the 4WD control to 2H at any forward speed.

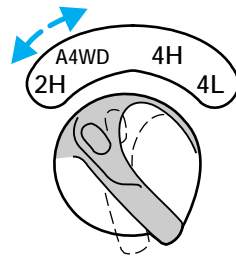
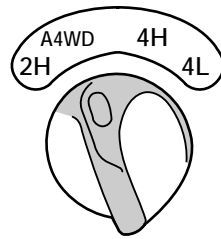

Shifting from 4H to 4L (and 4L to 4H)

1. Bring the vehicle to a stop.
2. Depress the brake.
3. Place the gearshift in N (Neutral).
4. Move the 4WD control to the 4H (or 4L) position.

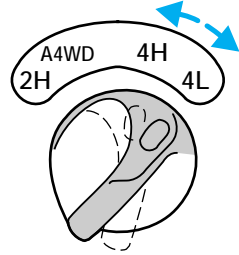

Shifting from A4WD to 4H

Move the 4WD control from A4WD to 4H at any forward speed. Shifting from 2H to 4H can be done at speeds up to 88 km (55 mph).

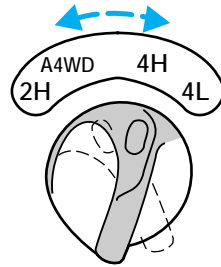

Driving

Driving off-road with 4WD

Your vehicle is specially equipped for driving on snow, sand, mud or other rough terrain and has operating characteristics that differ from those of other conventional vehicles.

When using 4WD, maintain steering wheel control at all times, especially in rough terrain. Since sudden changes in terrain can result in abrupt steering motion, always grip the steering wheel from the outside. Do not grip the spokes.

Drive cautiously to avoid vehicle damage from road debris such as rocks or stumps. Be sure to map out your route before driving in any off road area.

For more information on driving off-road and proper operation of your 4WD vehicle, refer the *Four Wheeling* supplement in your Owner's Portfolio.

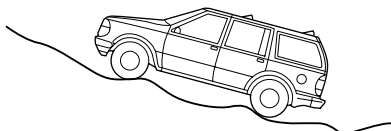
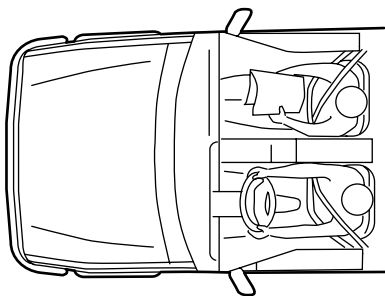

LOADING YOUR VEHICLE



It is extremely dangerous to ride in a cargo area, inside or outside of a vehicle. In a collision, people riding in these areas are more likely to be seriously injured or killed. Do not allow people to ride in any area of your vehicle that is not equipped with seats and safety belts. Be sure everyone in your vehicle is in a seat and using a safety belt properly.

Before loading your vehicle, familiarize yourself with the following terms:

- **Base curb weight** :Weight of the vehicle including any standard equipment, fluids, lubricants, etc. It does not include passengers or aftermarket equipment.
- **Payload** : Combined maximum allowable weight of passengers, cargo and optional equipment.
- **GVW (Gross Vehicle Weight)** — Base curb weight plus the payload weight. The GVW is not a limit or a specification.
- **GVWR (Gross Vehicle Weight Rating)** : Maximum total weight of the base vehicle, passengers, optional equipment and cargo. The GVWR is specific to each vehicle and is listed on the Safety Compliance Certification Label on the driver's door pillar.
- **GAWR (Gross Axle Weight**

Driving

Rating): Carrying capacity for each axle system (front and rear). The GAWR is specific to each vehicle and is listed on the Safety Compliance Certification Label on the driver's door.

- *GCWR (Gross combined weight rating)*: Maximum combined weight of the towing vehicle (including passengers and cargo) and the trailer. The GCWR indicates the maximum loaded weight that the vehicle is allowed to tow.
- *Maximum trailer weight*: Maximum weight of a trailer the loaded vehicle (including passengers and cargo) is permitted to tow. It is determined by subtracting the weight of the loaded towing vehicle from the GCWR of the towing vehicle.
- *Trailer weight range*: Specified weight range that the trailer must fall within that ranges from zero to the maximum trailer weight rating.

Payload = GVWR minus Base curb weight

To obtain the correct weights for your vehicle, try taking your vehicle to a shipping company or an inspection station for trucks.

Do not use replacement tires with lower weight capacities than the originals because they might lower the vehicle's GVWR and GAWR. Replacement tires with a higher

weight limit than the originals do not increase the GVWR or the GAWR limitations.

In high altitudes, engines will lose power at a rate of 3% power per 1000 ft increase in elevation. A reduction in GVW and GCW is recommended for maximum vehicle performance.

Remember to figure in the tongue load of your loaded trailer when figuring the total weight.



Do not exceed the GVWR or the GAWR specified on the Safety Compliance Certification Label.

Driving with a heavy load

The total vehicle weight plus the total weight of passengers and cargo should never exceed the GVWR.

The weight that the vehicle carries over the front and rear axles should never exceed the GAWR for the respective axle.

The weight limits of your vehicle's tires affect the GVWR or GAWR limitations. Using tires with higher weight limits than the original tires will not increase the GVWR or GAWR of your vehicle; using tires with lower weight limits may lower the GVWR or GAWR of your vehicle.

Driving

Using the luggage rack if equipped)

Load luggage at the front crossbar and adjust the rear crossbar as necessary.

- Do not exceed 90.7 kg (200 lb) of luggage if the weight is placed directly on the crossbars.
- Do not exceed 68 kg (150 lb) of luggage if the weight is resting on the roof itself.
- Be sure that the weight is evenly distributed, particularly when loading at or near the roof or luggage rack crossbars maximum capacity.

To remove the front crossbar:

1. Remove the knurled knobs.
2. Pull the crossbar rearward from the key slot.

To adjust the rear crossbar:

1. Side lever on each side of the rack rear locks and unlock the rear crossbar.
2. The rear crossbar can be removed by unlocking the levers and pulling the crossbar rearward.

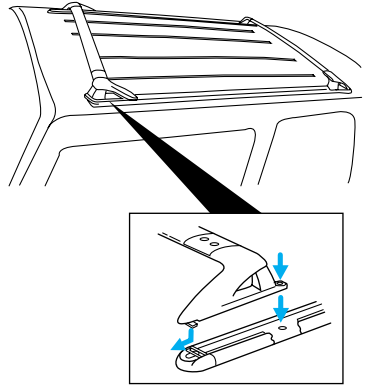

TRAILER TOWING

Trailer towing with your vehicle may require the use of a trailer tow option package.

Trailer towing puts additional loads on your vehicle's engine, transmission, axle, brakes, tires, and suspension. For your safety and to maximize vehicle performance, be sure to use the proper equipment while towing.

Follow these guidelines to ensure safe towing procedure:

- Stay within your vehicle's load limits.
- Thoroughly prepare your vehicle for towing. Refer to *Preparing to tow* in this chapter.
- Use extra caution when driving while trailer towing. Refer to *Driving while towing* in this chapter.
- Service your vehicle more frequently if you tow a trailer. Refer to the severe duty schedule in the "Service Guide".
- Do not tow a trailer until your vehicle has been driven at least 800 km (500 miles).
- Refer to the instructions included with towing accessories for the proper installation and adjustment specifications.

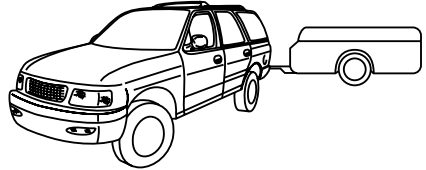

Driving

Trailer towing table (with heavy duty trailer tow option)				
GCWR (Gross Combined Weight Rating)/trailer weights				
Engine	Rear axle ratio	Tire size	Maximum GCWR	Trailer weight range (0 - maximum)
(4x2)				
4.6 L	3.31	40.6 cm (16 in)	4990 kg (11000 lb)	0-2676 kg (0-5900 lb)
5.4 L	3.31	40.6 cm (16 in)	5443 kg (12000 lb)	0-3039 kg (0-6700 lb)
5.4 L	3.73	40.6 cm (16 in)	6123 kg (13500 lb)	0-3628 kg (0-8000 lb)
(4x4)				
4.6 L	3.55	40.6 cm (16 in)	5216 kg (11500 kg)	0-2766 kg (0-6100 lb)
4.6 L	3.55	43.2 cm (17 in)	4990 kg (11000 lb)	0-2494 kg (0-5500 lb)
5.4 L	3.31	40.6 cm (16 in)	5443 kg (12000 lb)	0-2902 kg (0-6400 lb)
5.4 L	3.73	40.6 cm (16 in)	6123 kg (13500 lb)	0-3556 kg (0-7900 lb)
5.4 L	3.73	43.2 cm (17 in)	5897 kg (13000 lb)	0-3356 kg (0-7400 lb)
Maximum frontal area of trailer is 5.6 square meters (60 square feet)				

Do not exceed the maximum loads listed on the Safety Compliance Certification label. For load specification terms found on the label, refer to *Loading your vehicle* in this chapter. Remember to figure in the tongue load of your loaded trailer when figuring the total weight.

Your vehicle is not equipped with a neutral tow kit accessory. Do not attempt to flat tow your vehicle

with all of the vehicle wheels on the ground.



Towing trailers beyond the maximum recommended gross trailer weight exceeds the limit of the vehicle and could result in engine damage, transmission damage, structural damage, loss of control and personal injury.

Preparing to tow

Use the proper equipment for towing a trailer and make sure that it is properly attached to your vehicle. See your dealer or a reliable trailer retailer if you require assistance.

If your vehicle is not equipped with the factory heavy duty trailer tow option, auxiliary coolers are recommended for the automatic transmission system if you are planning on:

- traveling farther than 80 km (50 miles)
- towing in hilly terrain
- towing frequently

Calculating trailer loads

To determine the amount of weight that your vehicle can carry:

- Obtain ratings from the Safety Compliance Certification label and the trailer towing specifications in this chapter.

Driving

- Weigh your vehicle as you customarily operate the vehicle without cargo.
- Subtract the total weight of passengers, driver and aftermarket equipment and the obtained weight (in the step above) from the GCWR to determine the trailer weight your vehicle can tow.

Trailer weight range

The trailer weight range is the specified range by weight that the trailer must fall within. The range is between zero and the maximum trailer weight rating found in this chapter.

Using trailer brakes

Use electric brakes or manual, automatic or surge type hydraulic brakes that meet Federal and local regulations. Install and adjust brakes according to the manufacturer's instructions.



Do not connect a trailer's hydraulic brake system directly to your vehicle's brake system. Your vehicle may not have enough braking power and your chances of having a collision greatly increase.

Using safety chains

Always connect the trailer's safety chains to the vehicle. To connect the chains, cross the chains under the trailer tongue and attach to the

vehicle frame or hook retainers (not the bumper). Make sure there is enough slack to allow the vehicle to turn corners.

For more information, refer to “Ford Recreational Vehicle and Trailer Towing Guide” available from your Ford dealer.

Using trailer lamps

See your local trailer retailer or rental agency for proper instructions and equipment for hooking up trailer lamps.

Do not hook the trailer lights directly into the vehicle’s wiring system. If the trailer lamps are not connected properly, the warning lights in the instrument cluster may not work properly.

Using a hitch

Do not use hitches that:

- clamp onto the vehicle bumper
- attach to the axle.

Distribute the load so that only 10 to 15% of the total weight of the trailer is on the tongue. Tie down the load so that it does not shift and change the weight on the hitch. Follow the towing instructions of a reputable rental agency.

Using a load-equalizing hitch

Follow the hitch manufacturer’s guidelines for the installation and specific use of a load equalizing hitch on this vehicle. In no cases

Driving

should the vehicle weight ratings per axle or combination truck and trailer exceed the weight ratings listed on the Safety Compliance Certification label located on the driver's side door.

When connecting a trailer hitch:

1. Turn off the air suspension switch.
2. Connect the trailer.
3. Turn the air suspension back on.



Adjusting an equalizing hitch so the rear bumper of the vehicle is lower or higher than it was unloaded will defeat the function of the load equalizing hitch and may cause unpredictable handling.

Driving while towing a trailer

Speed control (if equipped) may not work properly while towing on long, steep grades.

Driving with an automatic transmission:

- use D, 1 or 2 rather than  while towing up or down steep hills
- anticipate stops and brake gradually.

Towing behind another vehicle

Your vehicle can not be flat towed with all wheels on the ground.

No neutral tow kit is available for your vehicle.

Servicing while towing

If you tow a trailer for long distances, your vehicle requires more frequent service than a vehicle not used for towing. Refer to the "Service Guide" *Severe Duty Schedule* for more information on maintenance intervals.

Using a step bumper

The rear bumper is equipped with an integral hitch and requires only a ball with a 1 inch shank diameter. The bumper has a 1814 kg (4000 lb) trailer weight and 181 kg (400 lb) tongue weight capability.

Use a frame mounted weight distributing hitch for trailers over 1814 kg (4000 lb).

FUEL CONSUMPTION

Fuel economy can be improved by avoiding:

- lack of regular, scheduled maintenance
- excessive speed
- rapid acceleration

Roadside emergencies

HAZARD LIGHTS CONTROL

Use only in an emergency to warn traffic of vehicle breakdown, approaching danger, etc. Depress to activate all indicators simultaneously. Depress again to switch off. The warning lights can be operated when the ignition is off.

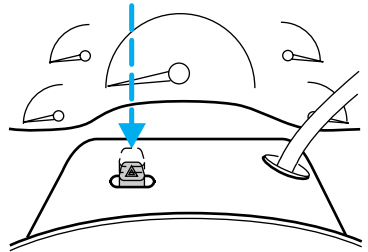

FUEL PUMP SHUT-OFF SWITCH

If the engine cranks but does not start after a collision, the fuel pump shut-off switch may have been activated. The shut-off switch is a device intended to stop the electric fuel pump when your vehicle has been involved in a substantial jolt.

Roadside emergencies

1. Turn the ignition switch to the OFF position.
2. Check fuel system for leaks.
3. If no fuel leak is apparent, reset the fuel pump shut-off switch by pushing in the button on the switch.
4. Turn the ignition switch to the ON position. Pause for a few seconds and return the key to the OFF position.
5. Make a further check for leaks in the fuel system.

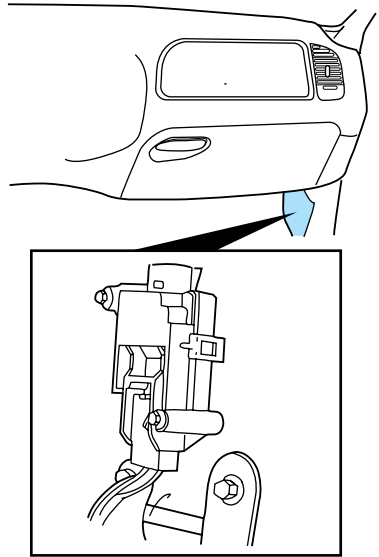

FUSES AND RELAYS

If electrical components in the vehicle are not working, a fuse may have blown. Blown fuses are identified by a broken element. Check the appropriate fuses before replacing any electrical components.

Use the fuse puller tool provided on the driver's compartment fuse panel cover to replace the fuses.



Always replace a fuse with one that has the specified amperage rating. Using a fuse with a higher amperage rating can cause severe wire damage and could start a fire.

Roadside emergencies

Even after a fuse is replaced, it will continue to blow if the cause of the overload is not identified and corrected. If the fuse continues to blow, have the vehicle's electrical system checked by a qualified service technician.

Fuse ratings

Fuse rating	Color
5 amp	Beige
10 amp	Red
15 amp	Blue
20 amp	Yellow
25 amp	Natural
30 amp	Green
40 amp	Orange
50 amp	Red
60 amp	Blue

Roadside emergencies

Power network box

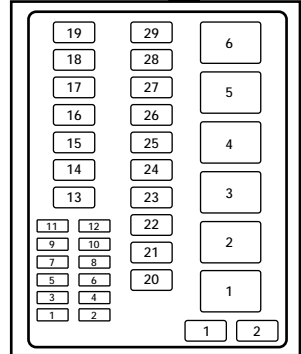
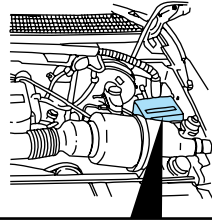

Slot number	Fuse amperage rating	Circuits protected
1	20 amp	Trailer tow backup & tail lamps
2	10 amp	Airbag diagnostic monitor
3	30 amp	Power locks
4	15 amp	Air suspension
5	20 amp	Horn
6	30 amp	Engine minifuse box fuses #3 and #5
7	15 amp	Park and tail lamps
8	30 amp	Headlamps
9	15 amp	Fog lamps and DRL
10	25 amp	Auxiliary instrument panel (I/P) power point
11	25 amp	Auxiliary console power point
12	10 amp	Rear wiper

Roadside emergencies

Slot number	Fuse amperage rating	Circuits protected
13	30 amp	Auxiliary blower
14	60 amp	Four wheel anti-lock brake system (4WABS)
15	50 amp	Air suspension compressor
16	40 amp	Trailer tow battery charge, engine minifuse box fuse #2, engine minifuse box fuse #4
17	30 amp	Four-wheel drive (4WD) transfer case motor and clutch
18	30 amp	Driver power seat
19	20 amp	Fuel pump
20	50 amp	Junction box ignition switched feed
21	50 amp	Junction box ignition switched feed
22	50 amp	Junction box battery feed
23	40 amp	Front blower
24	30 amp	Powertrain control module power
25	30 C.B.	Windows
26	-	not used
27	40 amp	Heated backlite and mirrors
28	30 amp	Trailer tow electric brake
29	30 amp	Hybrid fan, moon roof, flip windows

Slot number		Description
1	-	not used
2	-	PCM diode

Slot number		Description
1	-	Windshield wipers high/low speed
2	-	Windshield wipers run/park
3	-	Front washer pump relay
4	-	Fuel pump relay

Roadside emergencies

Slot number	Fuse amperage rating	Circuits protected
5	-	Horn relay
6	-	PCM power relay

Engine mini fuse box

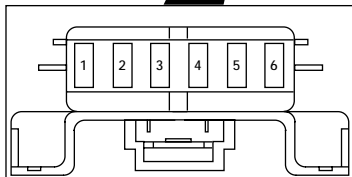
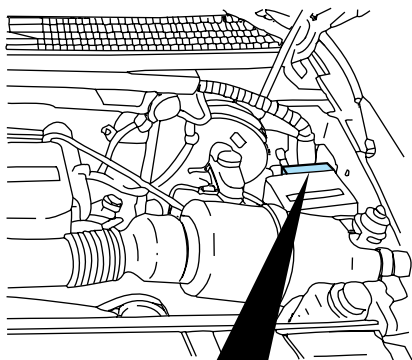

Slot number	Fuse amperage rating	Circuits protected
1	5 amp	Powertrain control module (PCM)
2	20 amp	Trailer tow stop/turn lamps
3	10 amp	Audio rear integrated control panel (RICP), compact disc changer, radio
4	10 amp	Running board lamps
5	20 amp	Amplifier, subwoofer amplifier
6	-	Not used

Roadside emergencies

Primary battery fuses

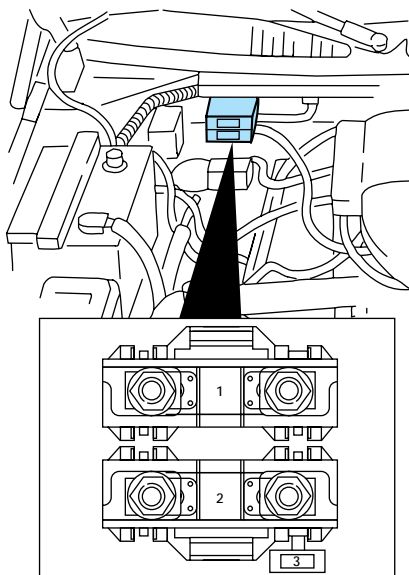

Location	Amperage	Description
1	175	Power network box megause
2	175	Alternator megafuse
3	20	Alternator field minifuse

Roadside emergencies

Junction box

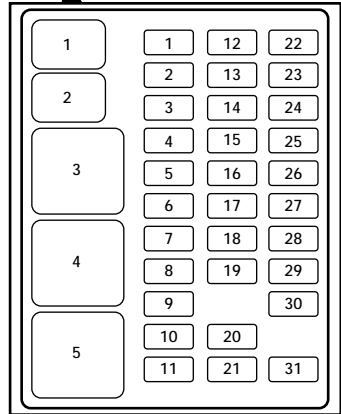
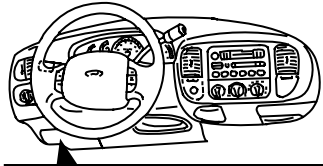

Slot number	Amperage	Description
1	15 amp	Stop/turn lamps
2	5 amp	Instrument cluster, trip computer
3	25 amp	Cigar lighter
4	5 amp	Autolamp module, head lamp relay, remote entry anti-theft with personality module (RAP), power mirrors
5	15 amp	Air condition (A/C) clutch, hybrid fan relay, backup lamps, speed control, DRL, instrument panel blend door actuator, electronic variable orifice (EVO) steering module

Roadside emergencies

Slot number	Amperage	Description
6	5 amp	Generic electronic module (GEM), shift interlock, air suspension module, heated backlite (HBL) relay, steering sensor, trip computer, compass
7	5 amp	Console blower, auxiliary blower relay coil
8	5 amp	GEM, radio, RAP module
9	-	Not used
10	-	Not used
11	30 amp	Front wiper motor, washer motor
12	5 amp	OBDII scan tool connector
13	15 amp	Brake on/off switch, brake pressure switch
14	15 amp	Interior lamps, delayed accessory relay, rear wiper relays
15	5 amp	GEM, passive anti-theft system (PATS) module
16	20 amp	High beam headlamps, high beam indicator
17	10 amp	Heated mirrors, heated mirror switch
18	5 amp	Instrument and switch illumination
19	10 amp	Airbag diagnostic monitor, instrument cluster
20	5 amp	GEM, air suspension module
21	15 amp	Starter relay, junction box fuse #20

Roadside emergencies

Slot number	Amperage	Description
22	10 amp	Airbag diagnostic monitor
23	10 amp	Electronic flasher, 4WD vacuum solenoids, trailer tow battery charge relay, console climate door actuator, auxiliary blend and mode door actuators, auxiliary pot switching module
24	10 amp	I/P blower relay, junction fuse box #7
25	5 amp	4WABS module, 4WABS red lamps relay
26	10 amp	Right low beam head lamp, DRL module
27	5 amp	Foglamp relay, main lamp switch
28	10 amp	Left low beam headlamp
29	5 amp	Auto lamp module, instrument cluster, transmission control indicator light and switch
30	30 amp	Ignition coils, PCM relay, PATS module, radio capacitors
31	-	Not used
Slot number	Amperage	Description
1	-	Interior lamp relay
2	-	Battery saver relay
3	-	HBL relay
4	-	One touch down relay
5	-	Accessory delay relay

Roadside emergencies

CHANGING THE TIRES

If you get a flat tire while driving, do not apply the brake heavily. Instead, gradually decrease your speed. Hold the steering wheel firmly and slowly move to a safe place on the side of the road:

- Park on a level spot.
- Turn off the ignition.
- Set the parking brake.
- Activate the hazard flashers.

Spare tire information

Your vehicle is equipped with a spare tire that may be used as a spare or as a regular tire. The spare is identical to the other tires on your vehicle, although the wheel cover may not match.

Location of the spare tire and tools

The spare tire and tools for your vehicle are stowed in the following locations:

Tool	Location
Spare tire	Under the vehicle, just in front of the rear bumper.
Jack, wheel nut wrench, instructions, work gloves	Behind the access panel located on the right rear quarter panel interior trim.
Jack handle	On the top of the radiator support at the front of the engine compartment.

Roadside emergencies

Removing the jack handle

1. Open the hood.
2. Un-snap the end of the handle that is retained by the clip on the top of the windshield washer bottle.
3. Un-snap the shaft of the handle from the two retaining clips attached to the top of the radiator shroud.

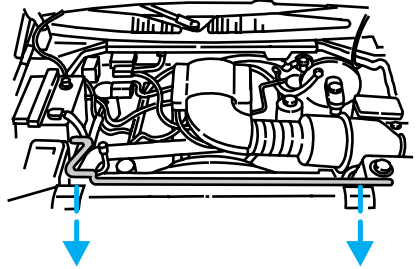

Removing the jack and tools

1. Locate the access panel on the interior trim. Lift and rotate the two panel retaining clips and remove panel.
2. Un-snap the wheel lug nut wrench, instructions and work gloves from their retaining bracket.
3. Remove the jack by turning the thumbwheel counterclockwise to relieve tension against the stowage bracket.

Removing the spare tire

1. Open the rear liftgate.
2. Insert the straight end of the jack handle into the rear access hole located just above the rear bumper.
 - Forward motion will stop and resistance to turning will be felt when properly engaged.
3. Turn the handle counterclockwise until tire is lowered to the ground and the cable is slightly slack.

Roadside emergencies

4. Remove the end of the cable from the wheel and slide the spare out from under the vehicle.

To re-install the spare tire or tools, reverse the removal procedure.



On vehicles equipped with Air Suspension, turn OFF the Air Suspension switch prior to jacking, hoisting or towing your vehicle.

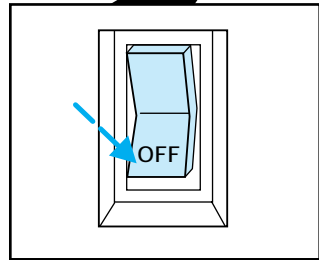
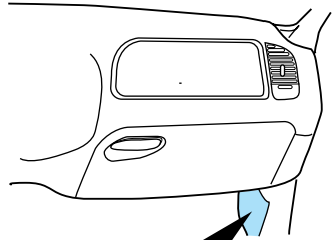

Tire change procedure

Refer to the instruction sheet for detailed tire change instructions.

1. Park on a level surface.
2. Activate the hazard flashers.
3. Set the parking brake.
4. Place the gearshift in P (Park).
5. Block the diagonally opposite wheel.

Removing flat tire and installing spare

6. Use the tip of the lug wrench to remove any wheel trim. Insert the tapered end of the lug wrench behind the wheel covers or hubcaps and twist off.

7. Loosen the wheel nuts with the lug wrench. Do not remove the lug nuts until the tire has been raised off the ground.

8. Insert the jack handle into the jack and use the handle to slide the jack under the vehicle.

9. Position the jack according to the following guides and turn the jack handle clockwise until the wheel is completely off the ground.

- When one of the back wheels is off the ground, the transmission alone will not prevent the vehicle from moving or slipping off the jack, even if the vehicle is in P (Park). To prevent the vehicle from moving when you change the tire, be sure that the parking brake is set and the diagonally opposite wheel is blocked. If the vehicle slips off the jack, someone could be seriously injured.

Roadside emergencies

Front (4x2)

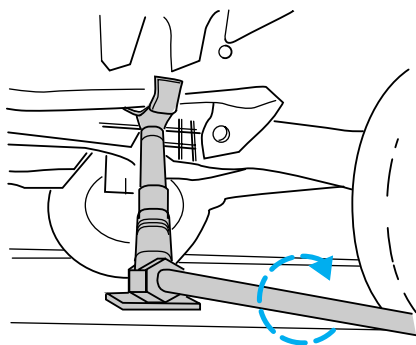

Front (4x4)

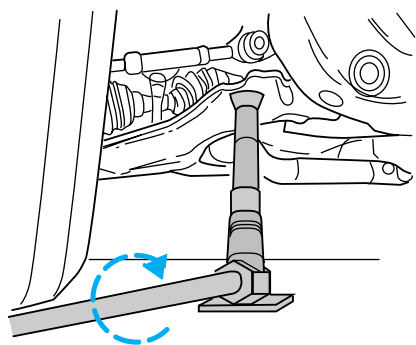

Roadside emergencies

Rear

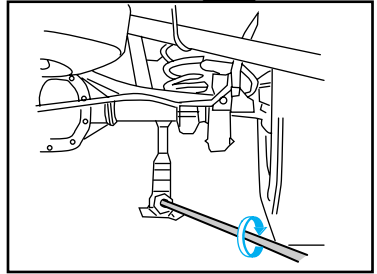
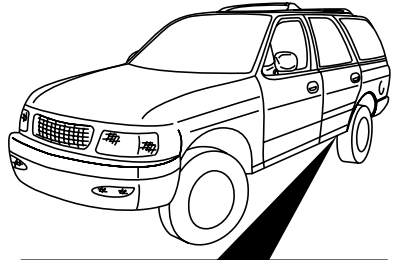

NEVER USE THE FRONT OR REAR DIFFERENTIAL AS A JACKING POINT.

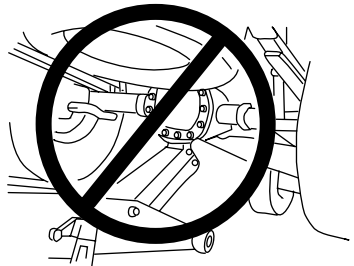

1. Remove the lug nuts with the lug nut wrench.
2. Replace the flat tire with the spare tire.
3. Thread the lug nuts on the wheel studs with the beveled face toward the wheel. Use the lug nut

Roadside emergencies

wrench to screw the lug nut snug against the wheel, but do not tighten.

4. Lower the vehicle by turning the jack handle counterclockwise.

5. Remove the jack and fully tighten the lug nuts to the proper torque specifications in the order shown.

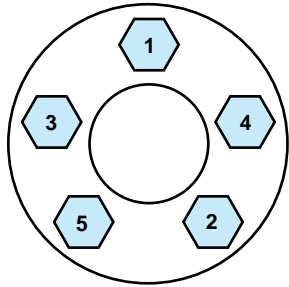

Never use wheels or lug nuts different than the original equipment as this could damage the wheel or mounting system. This damage could allow the wheels to come off while the vehicle is being driven.

6. Replace any wheel covers, ornaments or hub caps that your vehicle may have. Make sure that they are screwed or snapped into place.

7. Put the jack and wrench away. Ensure that the jack is securely fastened.

8. To stow the flat tire, lay the tire on the ground with the inboard side facing up. Install the retainer through the wheel center and slide the wheel under the vehicle. Turn the spare handle clockwise until the spare tire is raised to its original position underneath the vehicle. The spare handle ratchets when the tire is raised to the stowed position. It will not allow you to overtighten.

9. Unblock the wheels.

Roadside emergencies

10. On vehicles equipped with air suspension, turn ON the air suspension switch.
11. Retighten the wheel lug nuts to the specified torque at 800 km (500 miles) of new vehicle operation, after any wheel change or any time the lug nuts are loosened.



Failure to retighten wheel lug nuts at mileages specified could allow wheels to come off while the vehicle is in motion.

JUMP STARTING YOUR BATTERY

Jump starting your vehicle



The gases around the battery can explode if exposed to flames, sparks, or lit cigarettes. An explosion could result in injury or vehicle damage.



Do not push-start your vehicle. You could damage the catalytic converter. For further information, see *Jumper Cables* in the Index.



Batteries contain sulfuric acid which burns skin, eyes, and clothing.

Roadside emergencies

Connecting the jumper cables

1. Position the vehicles so that they do not touch one another.
2. Switch off the engine. Switch off any unnecessary electrical equipment.
3. Connect the positive (+) terminal of the discharged battery (1) to the positive (+) terminal of the booster battery (2).
4. Connect one end of the second lead to the negative (-) terminal of the booster battery (3) and the other end to a metal part of the engine to be started (4), not to the negative (-) terminal of the discharged battery.

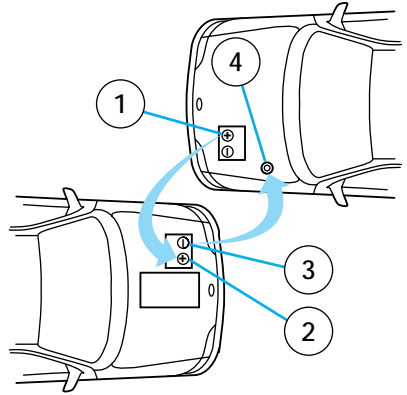

5. Make sure that the jump leads are clear of moving parts of the engine.



Do not connect the end of the second cable to the negative (-) terminal of the battery to be jumped. A spark may cause an explosion of the gases that surround the battery.

Jump starting

1. Start the booster vehicle and run the engine at moderately increased speed.
2. Start the engine of the vehicle with the discharged battery.

Roadside emergencies

3. Once the engine has been started, run both vehicles for a further three minutes before disconnecting the leads.

Removing the jumper cables

1. Remove the jumper cables in reverse order. Take the cable off the metallic surface (1) first, followed by the cable on the negative (-) booster battery terminal (2).
2. Remove the cable from the positive (+) terminal of the booster battery (3) and then the discharged battery (4).
3. After the disabled vehicle has been started, allow it to idle for a while so the engine can “relearn” its idle conditions.

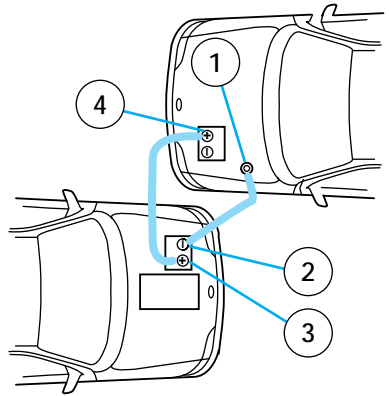

Roadside emergencies

WRECKER TOWING

If towing is necessary, it is recommended that your vehicle be towed with wheel lift or flatbed equipment. Do not tow with slingbelt equipment. Ford Motor Company has not developed or approved a slingbelt towing procedure.

On 4x2 vehicles, it is acceptable to tow the vehicle with the front wheels on the ground and the rear wheels off the ground.

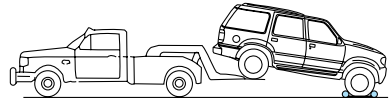
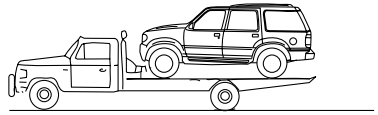
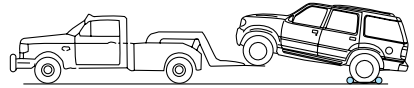

On vehicles equipped with Air Suspension, turn OFF the Air Suspension switch prior to jacking, hoisting or towing your vehicle.

Precautions when servicing your vehicle

Be especially careful when inspecting or servicing your vehicle. Here are some general precautions for your safety:

- Do not work on a hot engine.
- If you must work with the engine running, avoid wearing loose clothing or jewelry that could get caught in moving parts. Take precautions with long hair.
- Do not work on a vehicle with the engine running in an enclosed space, unless you are sure you have enough ventilation.
- Keep all lit cigarettes, open flames and other lit material away from the battery and all fuel related parts.

If you disconnect the battery, the engine must “relearn” its idle conditions before your vehicle will drive properly, as explained in *Battery* in this chapter.

Service recommendations

To help you service your vehicle:

- We highlight do-it-yourself items in the engine compartment for easy location.
- As possible, we design parts that can be replaced without tools.

Maintenance and care

- We provide you with a “Service Guide” which makes tracking routine service for your vehicle easy.

If your vehicle requires professional service, your dealership can provide necessary parts and service. Check your “Warranty Information Booklet” to find out which parts and services are covered.

Use only recommended fuels, lubricants, fluids and service parts conforming to specifications. Motorcraft parts are designed and built to provide the best performance in your vehicle.

Opening the hood

To open the hood:

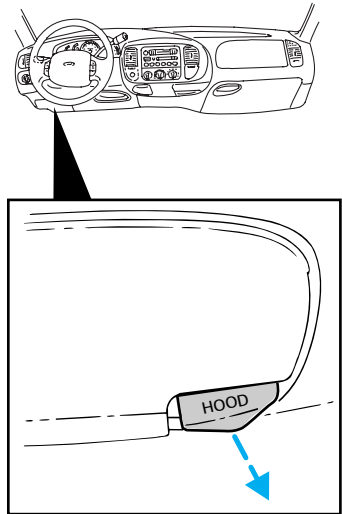

Maintenance and care

1. Inside the vehicle, pull the hood release handle located under the bottom left corner of the instrument panel.
 2. Outside the vehicle, release the auxiliary latch located under the center of the hood.
 3. Lift the hood.
 4. To close the hood, shut it so that the auxiliary latch is closed.
- After closing the hood, try lifting it to ensure that it is closed securely.

Working with the engine off

1. Set the parking brake fully and ensure the gearshift is securely latched in P (Park).
2. Turn off the engine and remove the key.
3. Block the wheels to prevent the vehicle from moving unexpectedly.

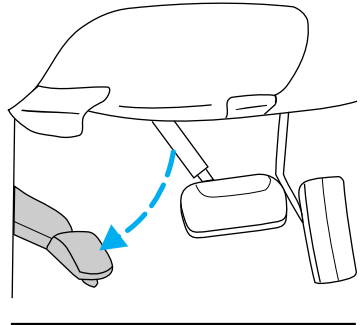

Maintenance and care

Working with the engine on

1. Set the parking brake fully and ensure the gearshift is securely latched in P (Park).
2. Block the wheels to prevent your vehicle from moving unexpectedly.

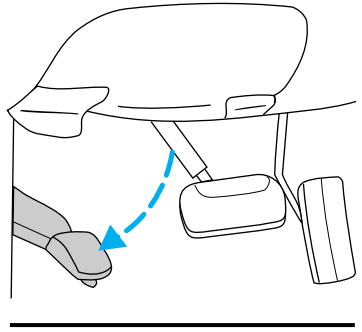

Do not start your engine with the air cleaner removed and do not remove it while the engine is running.

IDENTIFYING COMPONENTS IN THE ENGINE COMPARTMENT

4.6 / 5.4 L engine

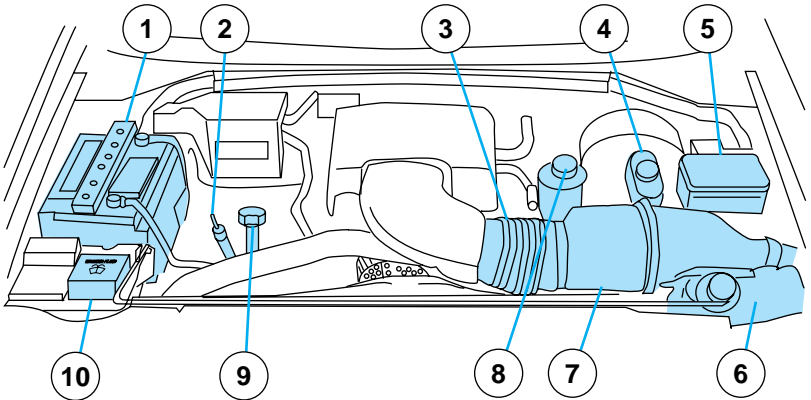

1. Battery
2. Automatic transmission dipstick

3. Engine oil dipstick (For more information on the engine oil dipstick location and maintenance, refer to *Checking and adding engine oil* in this chapter.)
4. Brake fluid reservoir
5. Engine compartment fuse panel
6. Engine coolant reservoir
7. Air cleaner filter
8. Power steering fluid reservoir
9. Engine oil filler cap
10. Washer fluid reservoir

CHECKING AND ADDING ENGINE OIL

Use WSS-M2C153-F motor oil CERTIFIED FOR GASOLINE ENGINES by the American Petroleum Institute.

Engine oils with an SAE 5W-30 viscosity and displaying the American Petroleum Institute certification mark are preferred for your vehicle. They provide the best engine performance, fuel economy and engine protection for all climates down to -25°C (-15°F).

Do not use:

- “non-detergent” oils
- oils labeled API SA, SB, SC, SD, SE, SF or SG
- additional engine oil additives, oil treatments or engine treatments

Additional engine oil additives, oil treatments or engine treatments

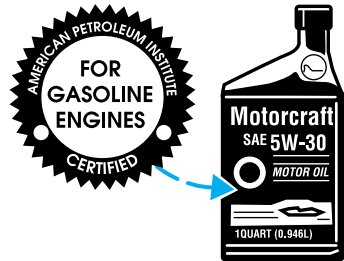

Maintenance and care

are never needed and could, under certain conditions, lead to engine damage which is not covered by your Ford warranty.

Synthetic engine oils which are CERTIFIED and of the preferred viscosity may be used in your engine. The engine oil and oil filter must still be changed according to the "Service Guide".

Checking the engine oil

Check the engine oil each time you fuel your vehicle.

To check the oil:

1. Make sure the vehicle is on level ground. If the engine is running, turn the engine off and wait a few minutes for the oil to drain into the oil pan.
2. Set the parking brake and ensure the gearshift is securely latched in P.
3. Open the hood. Protect yourself from engine heat.

Maintenance and care

4. Locate and carefully remove the engine oil dipstick.
5. Wipe the dipstick clean. Insert the dipstick fully, then remove it again. The oil level should be in the range shown on the dipstick.
6. If the oil level is below the minimum line, add engine oil as necessary. If the oil level is beyond the maximum line, engine damage or high oil consumption may occur and some oil must be removed from the engine by a service technician.
7. Put the dipstick back in and ensure it is fully seated.

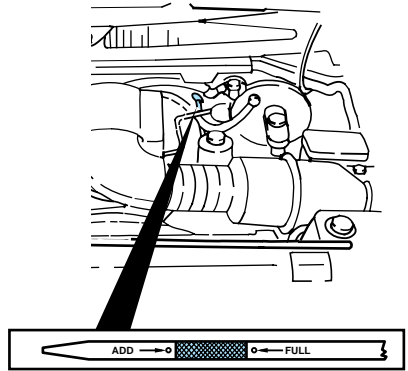

Adding engine oil

1. Check the engine oil. For instructions, refer to *Checking the engine oil* in this chapter.
2. If the fluid level is not within the normal range, add only certified engine oil of the preferred viscosity. Add engine oil through the oil filler cap. Remove the filler cap and use a funnel to pour oil in the opening.
3. Recheck the oil level. Make sure the oil level is not above the full mark on the dipstick.

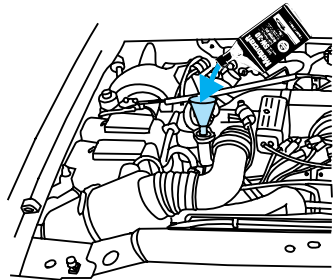

Continuous contact with **used** motor oil has caused cancer in laboratory mice.

Maintenance and care

Changing the engine oil and filter

Change your engine oil and filter according to the following kilometers (mileage) and time requirements, whichever occurs first:

- Normal Schedule – 8,000 km (5,000 miles) or six months.
- Severe Duty Schedule – 5,000 km (3,000 miles) or three months. Severe duty operation would include extensive idling, trailer towing, driving in severe dust and police, taxi or delivery service.

Ford production and aftermarket (Motorcraft) oil filters are designed for added engine protection and long life. If a replacement oil filter is used that does not meet Ford material and design specifications, startup engine noises or knock may be experienced.

It is recommended you use the appropriate Motorcraft oil filter (or another brand meeting Ford specifications) for your engine application.

Checking and adding brake fluid

Brake fluid should be checked and refilled as needed at least once each year:

Maintenance and care

- Clean the reservoir cap before removal to prevent dirt or water from entering the reservoir.
- Visually inspect the fluid level.
- If necessary, add brake fluid until the level reaches MAX. Do not fill above this line.
- Use only a DOT 3 brake fluid certified to meet Ford specifications. Refer to *Lubricant specifications* in the *Capacities and specifications* chapter.

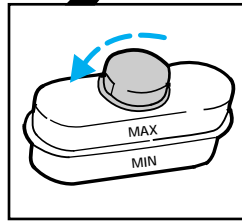
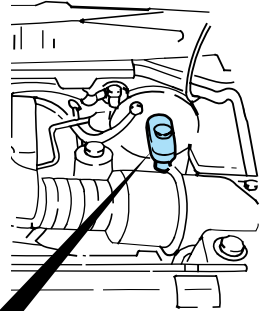

Brake fluid is toxic.



If you use a brake fluid that is not DOT 3, you will cause permanent damage to your brakes.



Do not let the reservoir for the master cylinder run dry. This may cause the brakes to fail.

Maintenance and care

CHECKING AND ADDING WASHER FLUID

Adding washer fluid

1. Lift the washer fluid reservoir cover.
2. Add washer fluid until the level reaches the FULL line.

Use only fluid that meets Ford Specifications. Refer to *Capacities and specifications*.

The addition of a bug shield to the front of the vehicle may adversely affect the washer system from delivering fluid to the windshield. Devices such as bug shields are not recommended.



Windshield washer fluid contains methanol and it is poisonous. Follow all instructions on the bottle of washer fluid.

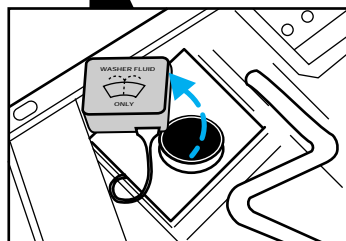
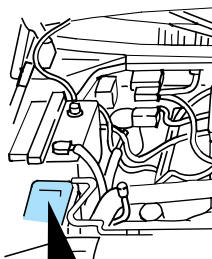

What you should know about washer fluid

In freezing weather [temperatures below 0°C (32°F)], use washer fluid containing a small amount of antifreeze, such as methanol. State or local regulations on volatile organic compounds (VOCs) may restrict the use of methanol, a common type of antifreeze.

Use a non-methanol antifreeze in freezing weather only if the fluid does not damage the paint finish, wiper blades and washer system.

Washer fluid in the liftgate reservoir

Washer fluid for liftgate wiper and washer operation is supplied by the washer fluid reservoir located in the engine compartment. For information on adding fluid to this main reservoir, refer to *Washer fluid in the windshield reservoir* in this chapter.

CHECKING AND ADDING ENGINE COOLANT

Adding engine coolant

 Do not put engine coolant in the container for the windshield washer fluid.

If sprayed on the windshield, engine coolant could make it difficult to see through the windshield.

When the engine is cool, add a 50/50 mixture of engine coolant and water to the engine coolant recovery reservoir — **DO NOT ADD DIRECTLY TO THE RADIATOR.** Add straight water only in an emergency, but you should replace it with a 50/50 mixture of coolant and distilled water as soon as possible.

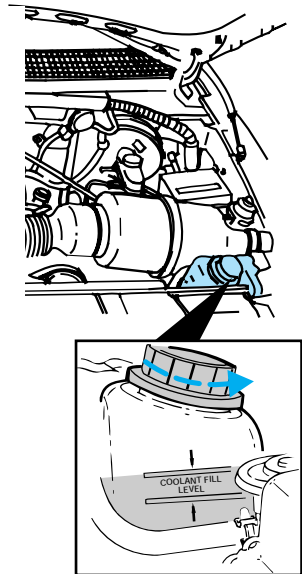

Maintenance and care

Check the coolant level in the coolant recovery reservoir the next few times you drive the vehicle. If necessary, add enough of a 50/50 mixture of coolant and water to bring the liquid level to the fill line on the reservoir.



Never remove the coolant recovery cap while the engine is running or hot.

If you must remove the coolant recovery cap, follow these steps to avoid personal injury:

1. Before you remove the cap, turn the engine off and let it cool.
2. When the engine is cool, wrap a thick cloth around the cap. Slowly turn cap counterclockwise to the first stop.
3. Step back while the pressure releases.
4. When you are sure that all the pressure has been released, use the cloth to press the cap down, turn it counterclockwise and remove it.

Use Ford Premium Cooling System Fluid E2FZ-19549-AA (in Canada, Motorcraft CXC-8-B) or an equivalent premium engine coolant that meets Ford Specification ESE-M97B44-A. Ford Premium Engine Coolant is an optimized formula that will protect all metals and rubber elastomers used in Ford cooling systems for 4 years or 80,000 km (50,000 miles).

Do not use alcohol or methanol antifreeze or any engine coolants mixed with alcohol or methanol antifreeze. Do not use supplemental coolant additives in your vehicle. These additives may harm your engine cooling system. The use of an improper coolant may void the warranty of your vehicle's engine cooling system.

Recycled engine coolant

Ford Motor Company recommends that Ford and Lincoln-Mercury dealers use recycled engine coolant produced by Ford-approved processes. Not all coolant recycling processes produce coolant which meets Ford specification ESE-M97B44-A, and use of such coolant may harm engine and cooling system components.



Always dispose of used automotive fluids in a responsible manner. Follow your community's regulations and standards for recycling and disposing of automotive fluids.

Coolant refill capacity

To find out how much fluid your vehicle's cooling system can hold, refer to *Refill capacities* in the *Capacities and specifications* chapter.

Have your dealer check the engine cooling system for leaks if you have to add more than a liter (quart) of engine coolant per month.

Maintenance and care

Severe winter climate

If you drive in extremely cold climates [less than 36°C (34°F)], it may be necessary to increase the coolant concentration above 50%. Refer to the chart on the coolant container to ensure the coolant concentration in your vehicle is such that the coolant will not freeze at the temperature level in which you drive during winter months. Never increase the engine coolant concentration above 60%. Leave a 50/50 mixture of engine coolant and water in your vehicle year-round in non-extreme climates.

Checking the cooling system hoses

Inspect all engine and heater system hoses and hose connections for:

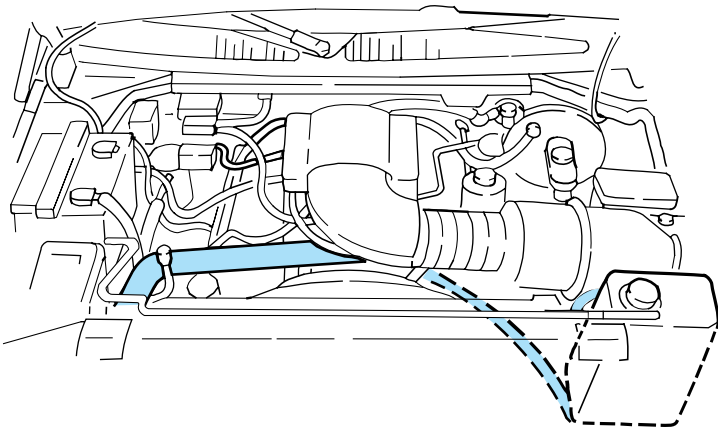

- deterioration
- leaks
- loose hose clamps

What you should know about fail-safe cooling

Vehicles equipped with 4.6L, and 5.4L engines have a fail-safe cooling mode. If the engine coolant supply is depleted, this feature allows the vehicle to be driven temporarily before incremental component damage is incurred. The “fail safe” distance depends on ambient temperatures, vehicle load and terrain.

When fail-safe mode is activated

- Pull off the road as soon as possible.
- Immediately turn the engine off to prevent severe engine damage.
- Wait for the engine to cool.
- Check the coolant level.

Maintenance and care

How fail-safe cooling works

If the engine overheats, the engine will automatically switch from eight to alternating four cylinder operation. Each disabled cylinder acts as an air pump and cools the engine.

When this occurs, the engine coolant temperature gauge will move into the red area and the  light illuminates.

The service engine soon light will illuminate, indicating that vehicle service is required.

The vehicle will still operate, but will have limited engine power and no air conditioning capability.

Continued operation will increase engine temperature and cause the engine to completely shut down. The vehicle will coast to a stop.

As the engine temperature cools, the engine may be re-started. Take your vehicle to a service facility as soon as possible to minimize engine damage.

CHECKING AND ADDING POWER STEERING FLUID

Check the power steering fluid level at least twice a year.

1. Start the engine.

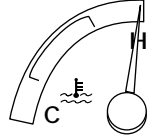

Maintenance and care

2. When the engine coolant temperature gauge reaches the normal zone, turn the engine off.

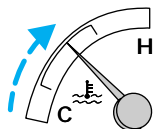

3. Visually inspect the fluid level in the power steering fluid reservoir.

4. Add power steering fluid until the fluid level reaches MAX.

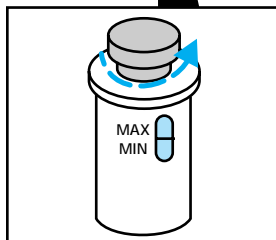
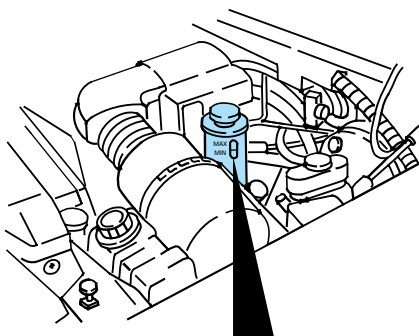

Use only fluid that meets Ford specifications. Refer to *Capacities and specifications*.

Maintenance and care

CHECKING AND ADDING TRANSMISSION FLUID

Checking and adding automatic transmission fluid (if equipped)

Service the automatic transmission according to the scheduled intervals in the "Service Guide."

Before adding any fluid, make sure the correct type will be used. This information is indicated on the dipstick.

- 4R70W automatic transmissions are used with 4.6 L engine applications.
- E4OD automatic transmissions are used with 5.4 L engine applications.

Do not drive the vehicle if the fluid level is below the bottom hole on the blade type dipstick (4R70W transmission) or below the COLD area on the bullet type dipstick (E4OD transmission) and outside temperatures are above 10°C (50°F).

Your vehicle does not use up transmission fluid. However, it is recommended that you check the transmission fluid at least twice a year. The fluid level should be checked if the transmission is not working properly, i.e., if the transmission slips or shifts slowly or if you notice some sign of fluid leakage.

It is preferable to check the transmission fluid level at normal operating temperature, after

Maintenance and care

approximately 32 km (20 miles) of driving. However, you can check the fluid level without driving to obtain a normal operating temperature if the outside temperature is above 10°C (50°F).

If your vehicle has been operated for an extended period at high speeds, in city traffic during hot weather or pulling a trailer, the vehicle should be turned off for about 30 minutes to allow the fluid to cool before checking.

1. Park the vehicle on a level surface.
2. Start the engine and move the gearshift lever through all of the gear ranges. Allow sufficient time for each gear to engage.
3. Latch the gearshift lever in P(Park), set the parking brake and leave the engine running.
4. Remove the dipstick, wiping it clean with a clean, dry rag.
5. Install the dipstick.
6. Remove the dipstick and inspect the fluid level.



Maintenance and care

For 4R70W transmissions, the fluid level should be within the crosshatched area, or if the vehicle has not been driven, between the holes near the bottom of the indicator.

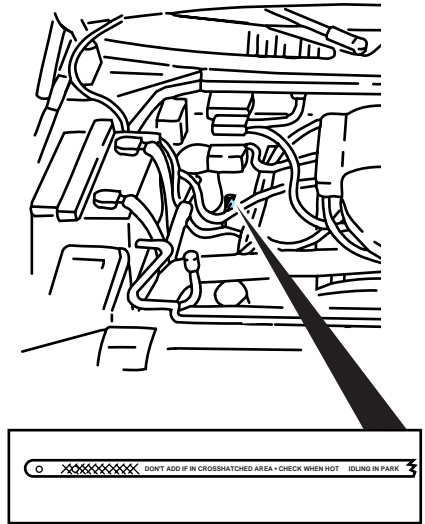

Maintenance and care

For E4OD transmissions, the fluid level should be within the HOT area, or if the vehicle has not been driven, within the COLD area.

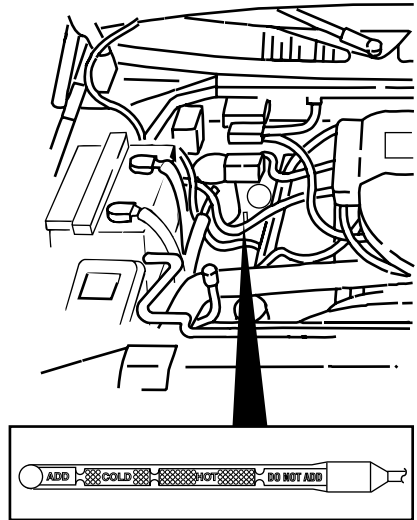

7. If necessary, add fluid in .25L (.5 pint) increments through the filler tube until the level is at the correct area on the dipstick. If an overfill occurs, excess fluid should be removed by a qualified technician.

REAR AXLE MAINTENANCE

The rear axle is filled with synthetic lubricant and will not require a lubricant change during the life of the vehicle unless the rear axle has been submerged in water. In addition, rear axle quantities are not to be checked or changed unless a leak is suspected or repair required.

Maintenance and care

TRACTION-LOK REAR AXLE (IF EQUIPPED)

This axle provides added drive away traction on slippery surfaces, particularly when one or more wheels are on a surface with poor traction.

Extended use of other than matching size tires on a Traction-Lok rear axle could result in a permanent reduction in effectiveness. This loss of effectiveness does not effect normal driving and should not be noticeable to the driver.



To avoid injury, never run the engine with one wheel off the ground, such as when changing a tire.

BATTERY

If the original equipment maintenance-free battery needs replacing, it may be replaced with a low-maintenance battery. For information on replacement batteries, refer to *Motorcraft part numbers* in the *Capacities and specifications* chapter.



The gases around the battery can explode if exposed to flames, sparks, or lit cigarettes. An explosion could result in injury or vehicle damage.



Batteries contain sulfuric acid which burns skin, eyes, and clothing.

Servicing your battery

A low-maintenance replacement battery has removable vent caps for checking the electrolyte level and adding water. Check the electrolyte level every 24 months or 40,000 km (24,000 miles) in average temperatures below 32°C (90°F).

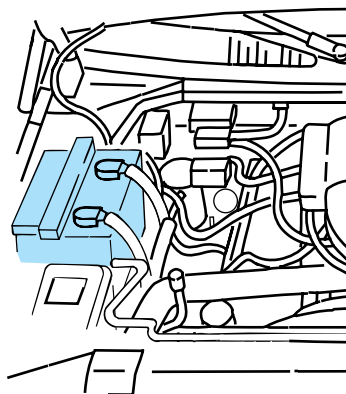

Keep the electrolyte level in each cell up to the level indicator. Do not overfill.

If the level gets low, refill the battery with distilled water. If the battery needs water quite often, have the charging system checked for a possible malfunction.

Your vehicle is equipped with a battery saver feature designed to prevent your battery from accidental wear down due to doors left ajar. For information on this system, refer to the *Controls and features* chapter.

Maintenance and care

Relearning idle conditions

Because your vehicle's engine is electronically controlled by a computer, some control conditions are maintained by power from the battery. When the battery is disconnected or a new battery is installed, the computer must "relearn" its idle conditions before your vehicle will drive properly. To complete this process:

1. Put the gearshift in P(Park).
 2. Turn off all accessories, and start the engine.
 3. Let the engine idle for at least one minute.
 4. *The relearning process will automatically complete as you drive the vehicle.*
- If you do not allow the engine to relearn its idle, the idle quality of your vehicle may be adversely affected until the idle is eventually relearned.
 - If the battery has been disconnected or a new battery has been installed, the clock and preset radio stations must be reset once the battery is reconnected.
 -  Always dispose of used automotive batteries in a responsible manner. Follow your community's standards for disposal. Call your local recycling center to find out more about recycling automotive batteries.

AIR CLEANER FILTER MAINTENANCE

Refer to the “Service Guide” for the appropriate intervals for changing the air cleaner filter.



Do not start your engine with the air cleaner removed and do not remove it while the engine is running.

CHANGING THE AIR FILTER

1. Loosen the clamp that secures the air cleaner in place.
2. Separate the two halves of the air cleaner.
3. Remove the air filter element from the open end of the engine air cleaner and replace it with a new element. Be careful not to crimp the filter edges between halves. This could cause filter damage if not properly seated.
4. Replace the two halves of the air cleaner and secure the clamp.

For information on replacement air filter elements, refer to the *Capacities and specifications* chapter.

CHECKING AND REPLACING WIPER BLADES

Checking wiper blades

Check the windshield wiper blades at least twice a year or whenever they seem to work less effectively than usual. Substances such as tree sap and some hot wax

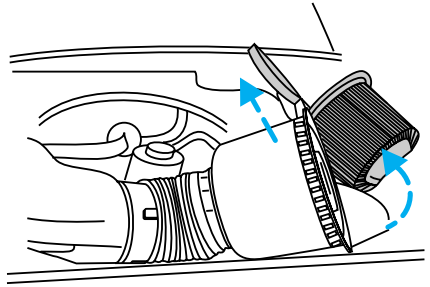

Maintenance and care

treatments used by commercial car washes can reduce the effectiveness of wiper blades.

To make reaching the wiper blades easier, simply:

1. Turn the ignition to the 3(On) position.

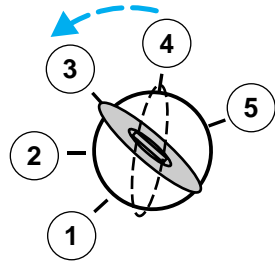

2. Turn the wipers on.

3. Wait for the wipers to reach a vertical position and turn the ignition to 2(Lock).

- Do not move the wipers manually across the windshield, this may cause damage to both wipers and windshield.

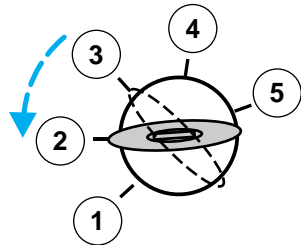

Replacing front wiper blades

If the wiper blades do not function properly after cleaning, replacement of the blade assembly or the blade element may be necessary.

The blade lengths for your vehicle are as follows:

- Front wiper blades — approximately 56 cm (22 in)
- Rear wiper blades — approximately 41 cm (16 in)

Maintenance and care

To replace the wiper blades:

1. Pull the wiper arm away from the windshield and lock into service position (front wiper only).
2. Turn the blade at an angle from the wiper arm. Push the lock pin with a screwdriver to release the blade and pull the wiper blade down toward the windshield to remove it from the wiper arm.
3. Attach the new wiper blade to the wiper arm and press it in place until a click is heard.

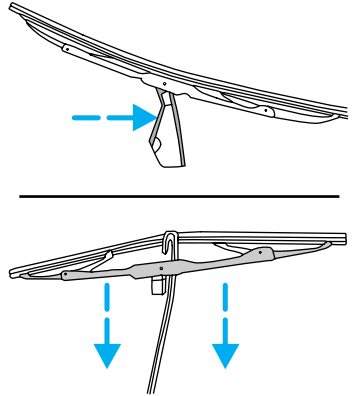

Replacing rear wiper blades

Unlike the front wiper, the rear wiper arm does not have a service position. Instead, follow these steps to change the rear wiper blade:

1. Lift the rear wiper arm out of the ramp position.
2. Pull out the arm and release the blade latch.
3. Manipulate the blade to remove it.
 - To rotate the liftgate wiper for removal, lift the wiper arm out of stop and pull the wiper arm away from liftgate at a 45° angle.
4. Attach the new wiper blade to the wiper arm and press into place until a click is heard.

Maintenance and care

IMPORTANT TIRE MAINTENANCE INFORMATION

Information about tire quality grades

New vehicles are fitted with tires that have their Tire Quality Grade (described below) molded into the tire's sidewall. These Tire Quality Grades are determined by standards that the United States Department of Transportation has set.

Tire Quality Grades apply to new pneumatic tires for use on passenger cars. They do not apply to deep tread, winter-type snow tires, space-saver or temporary use spare tires, tires with nominal rim diameters of 10 to 12 inches or limited production tires as defined in Title 49 Code of Federal Regulations Part 575.104(c) (2).

U.S. Department of Transportation-Tire quality grades: The U.S. Department of Transportation requires Ford to give you the following information about tire grades exactly as the government has written it.

Treadwear

The treadwear grade is a comparative rating based on the wear rate of the tire when tested under controlled conditions on a specified government test course. For example, a tire grade 150 would wear one and one-half (1 1/2) times as well on the government course as a tire grade

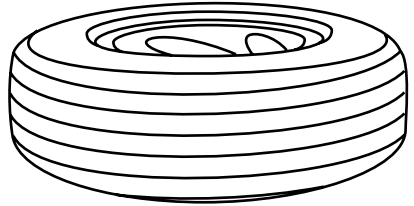

100. The relative performance of tires depends upon the actual conditions of their use, however, and may depart significantly from the norm due to variations in driving habits, service practices, and differences in road characteristics and climate.

Traction A B C

The traction grades, from highest to lowest are A, B, and C, and they represent the tire's ability to stop on wet pavement as measured under test surfaces of asphalt and concrete. A tire marked C may have poor traction performance. Warning: The traction grade assigned to this tire is based on braking (straightahead) traction tests and does not include cornering (turning) traction.

Temperature A B C

The temperature grades are A (the highest), B, and C, representing the tire's resistance to the generation of heat and its ability to dissipate heat when tested under controlled conditions on a specified indoor laboratory test wheel. Sustained high temperature can cause the material of the tire to degenerate and reduce tire life, and excessive temperature can lead to sudden tire failure. The grade C corresponds to a level of performance which all passenger car tires must meet under the Federal Motor Vehicle Safety Standard No. 109. Grades B and A represent higher levels of

Maintenance and care

performance on the laboratory test wheel than the minimum required by law.

 The temperature grade for this tire is established for a tire that is properly inflated and not overloaded. Excessive speed, underinflation, or excessive loading, either separately or in combination, can cause heat buildup and possible tire failure.

Checking the tire pressure

Check the tire pressure periodically and inflate tires as necessary. To check the tire pressure, insert the tire pressure gauge into the valve system.

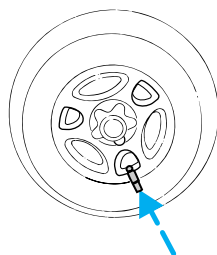

The cold pressure amount is listed on the Safety Compliance Certification label.

 Improperly inflated tires can affect vehicle handling and can fail suddenly, possibly resulting in loss of vehicle control.

Rotating the tires

Rotate your tires at regular intervals for even wear. Rotation intervals are listed in the “Service Guide”.

Maintenance and care

- **Four tire rotation**

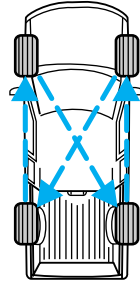

- **Five tire rotation**

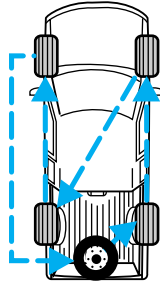

Replacing the tires

Replace the tires when the wear band is visible through the tire treads.

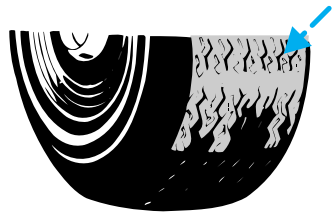

Maintenance and care



When replacing full size tires, never mix radial, bias-belted, or bias-type tires. Use only the tire sizes that are listed on the tire pressure decal. Make sure that all tires are the same size, speed rating, and load-carrying capacity. Use only the tire combinations recommended on the decal. If you do not follow these precautions, your vehicle may not drive properly and safely.



Make sure that all replacement tires are of the same size, type, load-carrying capacity and tread design (e.g., “All Terrain”, etc.), as originally offered by Ford.



Do not replace your tires with “high performance” tires or larger size tires.



Failure to follow these precautions may adversely affect the handling of the vehicle and make it easier to lose control and roll over.

Your vehicle requires the use of the following tire types:

- A/S BSW P255/70R 16
- A/T OWL P255/70R 16
- A/T OWL P265/70R 17

Maintenance and care

Ford recommends only tires of this type and size for your vehicle.

When purchasing replacement tires for your vehicle, consult your dealer or qualified service technician to ensure that the correct tire types are used.

Using snow tires and traction devices



Snow tires must be the same size and grade as the tires you currently have on your vehicle.

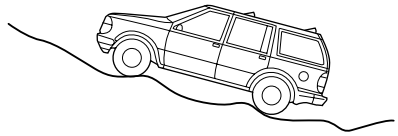

The tires on your vehicle have all—weather treads to provide traction in rain and snow. However, in some climates, using snow tires and traction devices may be necessary. Ford offers tire cables as a Ford approved accessory and recommends use of these or their equivalents. See your dealer or qualified service technician for more information on tire cables for your vehicle. Follow these guidelines when using snow tires and traction devices:

Maintenance and care

- Install cables securely, verifying that the cables do not touch any wiring, brake lines or fuel lines.
- Drive cautiously. If you hear the cables rub or bang against the vehicle, stop and retighten them. If this does not work, remove the cables to prevent vehicle damage.
- Avoid overloading your vehicle.
- Remove the tire cables when they are no longer needed.
- Do not use cables on dry roads.
- The suspension insulation and bumpers will help prevent vehicle damage. Do not remove these components from the vehicle when using snow tires and traction devices.
- Do not exceed 48 km/h (30 mph) with tire cables on your vehicle.

Consult your dealer for information on other Ford approved methods of traction control.

FUEL INFORMATION

The ignition key must be turned to 3 (Off) or 1 (Acc) during refueling to obtain accurate fuel gauge ratings.

Important safety precautions

 Do not overfill the fuel tank. The pressure in an overfilled tank may cause leakage and lead to fuel spray and fire.

 If you do not use the proper fuel cap, the pressure in the fuel tank can damage the fuel system or cause it to work improperly in a collision.

 The fuel system may be under pressure. If the fuel cap is venting vapor or if you hear a hissing sound, wait until it stops before completely removing the cap.

 Automotive fuels can cause serious injury or death if misused or mishandled.

Observe the following guidelines when handling automotive fuel:

- Extinguish all smoking materials and any open flames before fueling your vehicle.
- Always turn off the vehicle before fueling.
- Automotive fuels can be harmful or fatal if swallowed. If fuel is swallowed, call a physician immediately, even if no symptoms are immediately

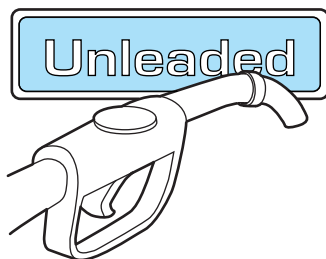

Maintenance and care

apparent. The toxic affects of fuel may not be visible for hours.

- Fuels can also be harmful if absorbed through the skin. If fuel is splashed on the skin, promptly remove contaminated clothing and wash skin thoroughly with soap and water.
- If fuel is splashed in the eyes, remove contact lenses, flush with water for 15 minutes and seek medical attention.
- Be particularly careful if you are taking “Antabuse” or other forms of disulfiram for the treatment of alcoholism. Breathing gasoline vapors or skin contact could cause an adverse reaction. Consult a physician immediately.

Choosing the right fuel

Use only UNLEADED FUEL. The use of leaded fuel is prohibited by law and could damage your vehicle. The damage may not be covered by your warranty.

Your vehicle was not designed to use fuel containing manganese-based additives such as MMT. Additionally, vehicles certified to California emission standards (indicated on the underhood Vehicle Emissions Control Information label) are designed to operate on California reformulated gasolines. If California reformulated gasoline is not available when you refuel, your

vehicle can be operated on non-California fuels. However, even though your engine will perform adequately on other gasolines, the performance of the emission control devices and systems may be adversely affected. Repair of damage caused by using a fuel that your vehicle was not designed for may not be covered by your warranty.

Octane recommendations

Your vehicle is designed to use regular gasoline with an (R+M)/2 octane rating of 87. We do not recommend gasolines labeled as “regular” in high altitude areas that are sold with octane ratings of 86 or even less.

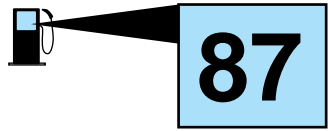

Do not be concerned if your vehicle sometimes knocks lightly. However, if it knocks heavily under most driving conditions on the recommended octane fuel, see your dealer or a qualified service technician to prevent any engine damage.

Fuel quality

If you are experiencing starting, rough idle or hesitation problems try a different brand of fuel. If the condition persists, see your dealer or a qualified service technician.

The American Automobile Manufacturers Association (AAMA)

Maintenance and care

issued a gasoline specification to provide information on high quality fuels that optimize the performance of your vehicle. We recommend the use of gasolines that meet the AAMA specification if they are available.

It should not be necessary to add any aftermarket products to your fuel tank if you continue to use a high-quality fuel.

Cleaner air

Ford approves the use of gasolines to improve air quality, including reformulated gasolines, that contain oxygenates such as a maximum of 10% ethanol or 15% MTBE. There should be no more than 5% methanol with cosolvents and additives to protect the fuel system.

Filling the fuel tank

1. Turn the engine off. After opening the fuel door, remove the cap carefully and slowly by turning it counterclockwise $\frac{1}{4}$ turn until it stops. Pull to remove the cap. A tether attaches the cap to the fuel filler pipe.

2. Make sure that you pump unleaded fuel and put the nozzle inside the fuel filler pipe.

- To optimize fill, it may be necessary to reposition the nozzle in the filler pipe.

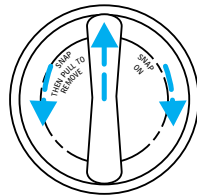

- The help reduce early nozzle shut offs and fuel spillage, park your vehicle so that the fuel filler door is level.
- Avoid excessively fast fuel dispensing rates (over 38 L [10 gallons] per minute).
- If you spill any fuel on the body of your vehicle, clean it off immediately. The fuel may dull or soften the paint if it is not washed off promptly.

3. To replace the fuel cap, align the tabs on the cap with the notches on the filler pipe. Turn it clockwise until it stops.

4. Push the fuel door closed.

If the check engine warning light illuminates and remains illuminated while the engine is started, the fuel cap may not be properly seated. Turn off the engine, remove the fuel cap and replace it, being sure to align the cap properly.

If the fuel cap is lost, replace it with an authorized Motorcraft or equivalent part.

Calculating fuel economy

To accurately calculate your vehicle's fuel economy:

1. Fill the tank completely and record the initial odometer reading.
2. Each time you fill the tank, record the amount of fuel added (in liters or gallons).

Maintenance and care

3. After at least three to five fuel tank fill-ups, fill the fuel tank and record the current mileage reading.

4. Use one of the following equations to calculate fuel economy.

Liters used x 100 ÷ Total kilometers traveled

Total miles traveled ÷ Total gallons used

Keep a record for at least one month. This will provide an accurate estimate of the vehicle's fuel economy.

WHAT YOU SHOULD KNOW ABOUT THE EMISSION CONTROL SYSTEM

For more information on your vehicle's emission control system, refer to the Vehicle Emission Control Information Decal located on the inside, left of the engine compartment.

The catalytic converter enables the vehicle's emission control system to operate properly.

Follow these guidelines to ensure proper emission system operation:

- Use only unleaded fuel.
- Avoid running out of fuel.

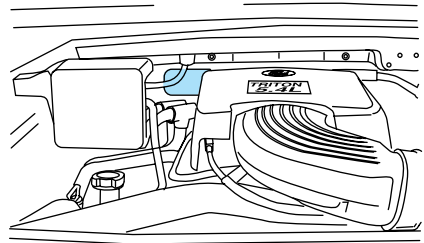

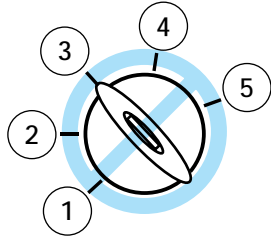

Maintenance and care

- Do not turn off the ignition while your vehicle is in motion.
- Have maintenance performed according to intervals in the “Service Guide”.



If you notice one or more of the following, the emission system may not be functioning properly; have the vehicle serviced as soon as possible:

- Fluid leaks
-   lights illuminate in the instrument cluster and remain lit
- Strange odors
- Engine runs for more than five seconds after shut off or engine misfires, surges, stalls or backfires
- Loss of oil pressure

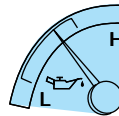

Maintenance and care

Important emission control information

By law, anyone who manufactures, repairs, services, leases, trades vehicles or supervises a fleet of vehicles is not permitted to intentionally remove an emission control device or prevent it from working. Do not make any unauthorized changes to the vehicle or engine. Changes that cause more unburned fuel to reach the exhaust system can increase the temperature of the engine or exhaust system.

When your vehicle is serviced, never use a metal exhaust collector. The use of a metal collector may melt or deform plastic parts.



Do not park, idle, or drive your vehicle in dry grass or other dry ground cover. The emission system heats up the engine compartment and exhaust system, which can start a fire.

Preparing your vehicle for inspection/maintenance (I/M) testing

In some localities it may be a legal requirement to pass an I/M test of the on-board diagnostic (OBD II) system. If your vehicle's powertrain system or battery has just been serviced, the OBD II system is reset to a condition unready for I/M testing. To ready the OBD II system for I/M testing, the law

Maintenance and care

specifies that additional city and highway driving is necessary to complete the check of the OBD II system.

The driving modes required to reach the ready condition consist of a minimum of 30 minutes of city and highway driving:

- At least 20 minutes driving in stop and go city-type traffic with at least four idle periods.
- At least ten minutes of driving on an expressway or highway.

Before completing the above driving modes, the engine must be warmed up and at operating temperature. Once started, the vehicle must not be turned off during these modes.

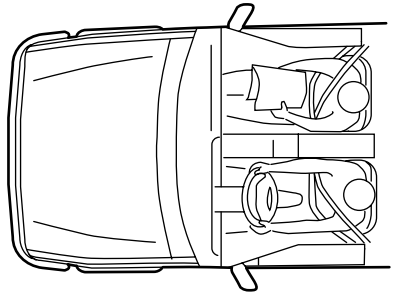

Maintenance and care

REPLACING THE EXTERIOR BULBS

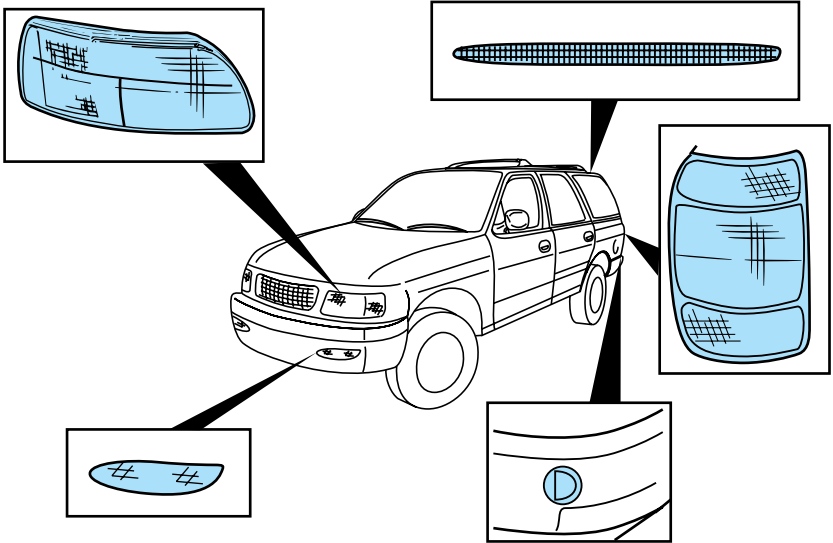

Check the operation of the following exterior lamps frequently:

- headlamps
- foglamps
- high-mount brakelamp
- license plate lamp
- tail lamps
- back-up lamps

Do not remove lamp bulbs unless they may be replaced immediately with new ones. If a bulb is removed for an extended period of time, contaminants may enter the lamp housings and affect lamp performance.



Handle a halogen headlamp bulb carefully and keep out of children's reach. Grasp the bulb only by its plastic base and do not touch the glass. The oil from your hand could cause the bulb to break the next time the headlamps are operated.

Replacement bulbs

For specifications for exterior and interior replacement bulbs for your vehicle, refer to *Bulb specifications* in this chapter.

Replacing headlamp bulbs



Handle a halogen headlamp bulb carefully and keep out of children's reach. Grasp the bulb only by its plastic base and do not touch the glass. The oil from your hand could cause the bulb to break the next time the headlamps are operated.

1. Make sure that the headlamp control is in the OFF position.
2. Open the hood.

Maintenance and care

3. At the back of the headlamp, pull clips rearward and up (about $\frac{3}{4}$ ") to release the headlamp assembly.

4. Slide headlamp assembly forward and off of guide ribs to expose the back of the bulb and wiring connector.

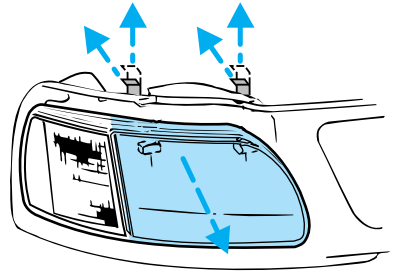

5. Remove the electrical connector from the bulb by grasping the wire and pulling it rearward.

6. Remove bulb retainer ring by turning it counterclockwise about $\frac{1}{4}$ turn, then slide the ring off the plastic base.

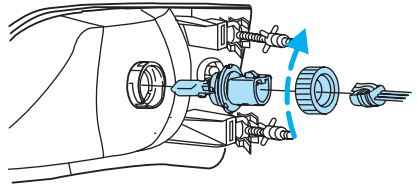

7. Without turning, carefully pull bulb assembly out of headlamp assembly.

8. Insert the glass end of the new bulb into the headlamp assembly socket. When the grooves in the plastic base are aligned, push the bulb into the socket until the plastic base contacts the rear of the socket.

9. Slip bulb retaining ring over the plastic base and lock the ring into the socket by turning it clockwise until you feel a "stop."

10. Push the electrical connector into the rear of the plastic base until it "snaps."

11. Straighten alignment pins, making them parallel with the outer edges of the attachment standoff.
12. Carefully insert the headlamp assembly into the vehicle making sure the alignment pins are inserted into the proper holes and into the guide ribs.
13. Hold the headlamp assembly snugly against the vehicle and push down on the clips to lock the lamp into position.

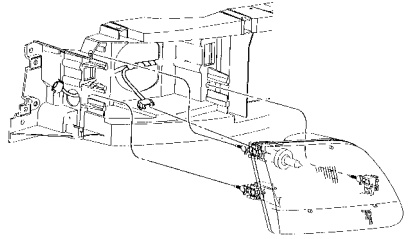

Replacing parking lamp/turn signal bulbs

1. Remove screw from the top of lamp assembly.
2. Disengage lamp assembly (it has a snap fit).

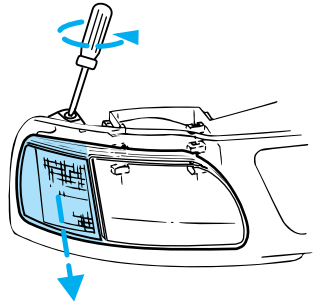

Maintenance and care

3. Remove the electrical connector from the bulb by grasping the wire and pulling it rearward.
4. Remove bulb retainer ring by turning it counterclockwise about 1/4 turn, then slide the ring off the plastic base.
5. Without turning, carefully pull bulb assembly out of parking lamp assembly.
6. Insert the glass end of the new bulb into the parking lamp assembly socket. When the grooves in the plastic base are aligned, push the bulb into the socket until the plastic base contacts the rear of the socket.
7. Slip bulb retaining ring over the plastic base and lock the ring into the socket by turning it clockwise until you feel a “stop.”
8. Push the electrical connector into the rear of the plastic base until it “snaps.”
9. Align top and bottom ribs of parking lamp assembly with corresponding slots on front of vehicle.
10. Push gently until parking lamp assembly seats (you will hear a snap).
11. Replace screw removed in step 1.

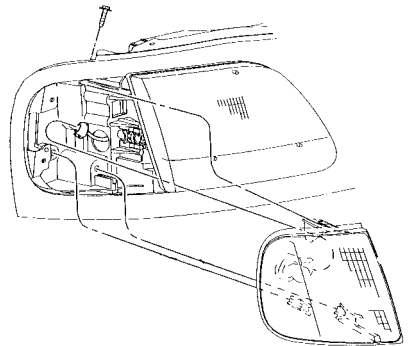
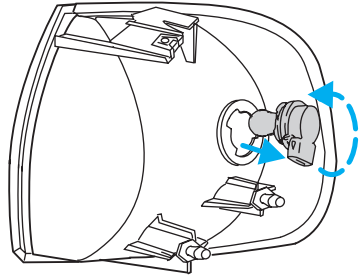

Maintenance and care

Replacing foglamp bulbs

1. Disconnect the electrical connector from the back of the foglamp assembly.
2. Twist, then pull the bulb from the foglamp assembly.
3. Install the new bulb.
4. Connect the electrical connector to the back of the foglamp assembly.

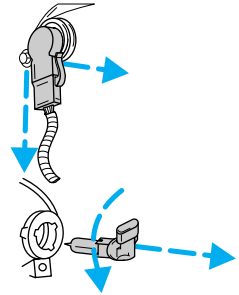

High-mount brakelamp

To change the high-mount brakelamp bulbs:

1. Remove the four screws that secure the high-mount brakelamp lens.
2. Carefully remove the lens.
3. Each of the three bulbs may be removed with a $\frac{1}{4}$ turn counterclockwise and a careful pull.
4. Replace the bulbs as needed and replace the high-mount brakelamp lens.

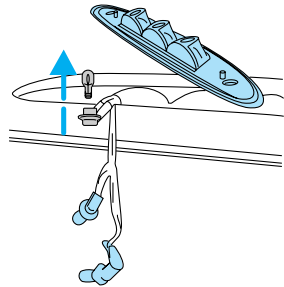
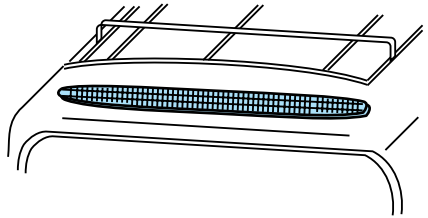

Maintenance and care

Replacing tail lamp/backup lamp bulbs

The tail lamp/backup lamp assemblies are located in the same portion of the vehicle rear, one just below the other. Follow the same steps to replace either bulb:

1. Open the liftgate to expose the lamp assemblies.
2. Remove the two screws at the top of the lens.
3. Carefully pop the lens off and to the right (it may be necessary to use a screwdriver to remove the lens).
4. Twist the connector $\frac{1}{4}$ turn counterclockwise and pull it out for replacement.
5. Pull the bulb straight out of the recess and replace it.
6. Replace the lens and secure the two screws.

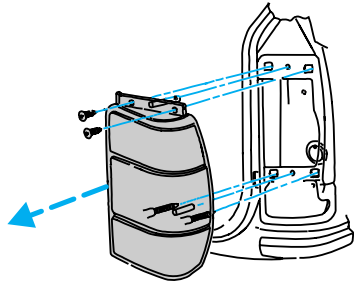

Replacing license plate lamp bulbs

The license plate bulbs are located under and behind the rear bumper. To change the license plate lamp bulbs:

1. Reach under and behind the rear bumper to locate the bulb connector.
2. Twist the connector counterclockwise $\frac{1}{4}$ turn and carefully pull to remove it.
3. Pull out the old bulb and press in the replacement bulb.

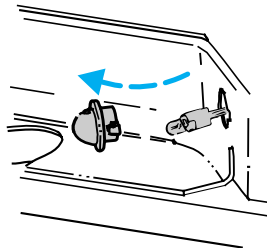

4. Replace the connector by placing it back into the assembly and turning it $\frac{1}{4}$ turn clockwise.

REPLACING THE INTERIOR BULBS

Check the operation of the following interior bulbs frequently:

- interior overhead lamp
- map lamp
- courtesy and cargo lamps
- hazard flasher

Map lamps

To change the map lamp bulbs:

1. Use a small screwdriver to remove the map lamp lens.
2. To remove the old bulb, twist $\frac{1}{4}$ turn and pull it out.
3. Twist in a new bulb.
4. Press the map lamp lens back on and test the lamp operation.

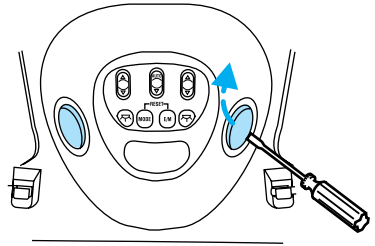

BULB SPECIFICATIONS

Function	Number of bulbs	Trade number
Front park/turn lamps	2	3157NAK
Foglamps	2	9006
Headlamps	2	9007
Rear/turn/sidemarkers	2	3157K
To replace all instrument panel lights - see your dealer.		

Maintenance and care

AIMING THE HEADLAMPS

The alignment of your headlamps should be checked by a qualified service technician if:

- Oncoming motorists frequently signal you to deactivate your high beams, and your high beams are not activated.
- The headlamps do not seem to provide enough light for clear night vision.
- The headlamp beams are pointed substantially away from a slightly down and to the right position.

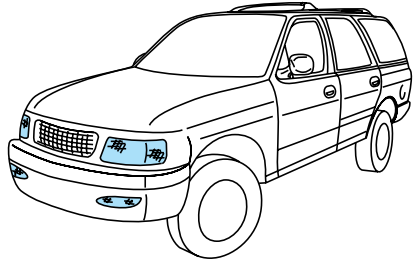

CLEANING AND CARING FOR YOUR VEHICLE

Washing your vehicle

Wash your vehicle regularly with cold or lukewarm water. Never use strong detergents or soap. If your vehicle is particularly dirty, use a quality car wash detergent. Always use a clean sponge, washing glove or similar device and plenty of water for best results. To avoid spots, avoid washing when the hood is still warm, immediately after or during exposure to strong sunlight.

During winter months, it is especially important to wash the vehicle on a regular basis. Large quantities of dirt and road salt are difficult to remove, and they also cause damage to the vehicle. Remove any exterior accessories,

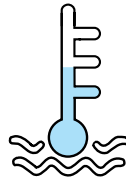

such as antennas, before entering a car wash.

- After washing, apply the brakes several times to dry them.

Waxing your vehicle

The best way to determine when the paintwork needs waxing is by noting when water stops beading on the surface. This could be every three or four months, depending on operating conditions.

Use only carnauba or synthetic-based waxes. Remove any bugs and tar before waxing vehicle. Use cleaning fluid or alcohol with a clean cloth to remove. Use tar remover to remove any tar spots.

Repairing paint chips

Minor scratches or paint damage from road debris may be repaired with touch-up paint, paint repair foil or aerosol paint spray from the Ford accessory line. Observe the application instructions on the products.

Remove particles such as bird droppings, tree sap, insect remains, tar spots, road salt and industrial fallout immediately.

Maintenance and care

Cleaning the wheels

Wash the wheels with the same detergent you use to clean the body of your vehicle. Do not use acid-based wheel cleaners, steel wool, fuel or strong detergents. Never use abrasives that will damage the finish of special wheel surfaces. Use a tar remover to remove grease and tar.

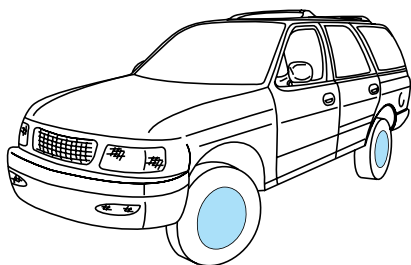

Cleaning the engine

Engines are more efficient when they are clean because grease and dirt buildup act as insulators and keep the engine warmer than normal. Follow these guidelines to clean your engine:

- Take care when using a power washer to clean the engine. The high pressure fluid could penetrate the sealed parts and cause damage.
- Do not spray with cold water to avoid cracking the engine block.

Maintenance and care

- Cover the highlighted areas to prevent water damage when cleaning the engine.

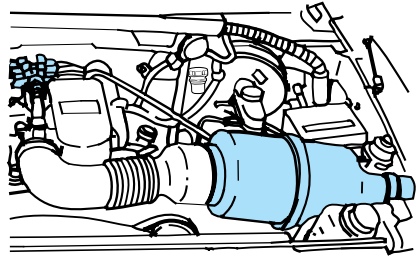
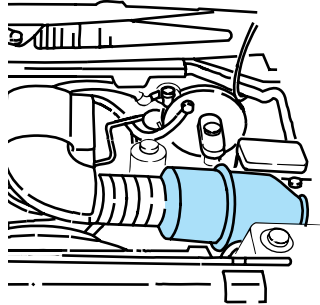

- Never wash or rinse the engine while it is running; water in the running engine may cause internal damage.

Cleaning plastic exterior parts

Use a vinyl cleaner for routine cleaning of plastic. Clean with a tar remover if necessary. Do not clean plastic parts with thinners, solvents or petroleum-based cleaners.

Maintenance and care

Cleaning the exterior lamps

Wash the exterior lamps with the same detergent you used to wash the exterior of your vehicle. Use glass cleaner or tar remover if necessary.

To avoid scratching the lamps, do not use a dry paper towel, chemical solvents or abrasive cleaners to clean the lamps.

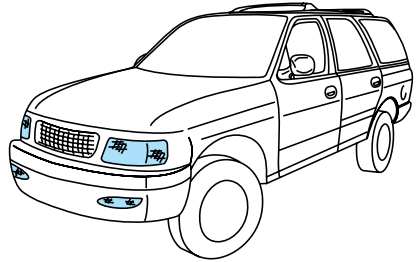

Cleaning the wiper blades

If the wiper blades do not wipe properly, clean both the windshield and wiper blades using undiluted windshield wiper solution or a mild detergent. Rinse thoroughly with clean water. To avoid damaging the blades, do not use fuel, kerosene, paint thinner or other solvents.

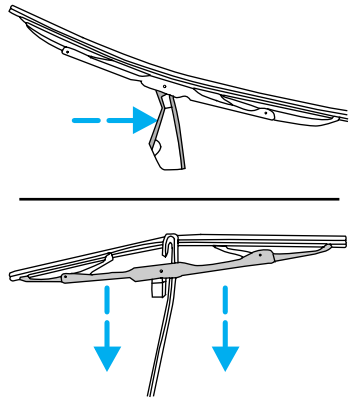

Cleaning the instrument panel

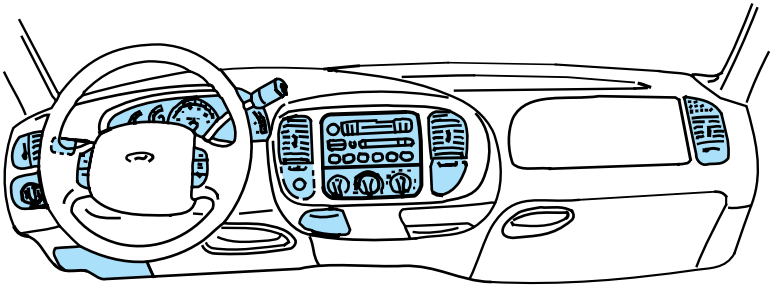

Clean instrument panel with a damp cloth, then dry with a dry cloth.

Any cleaner or polish that increases the gloss of the upper portion of the instrument panel should be avoided. The dull finish in this area is to help protect the driver from undesirable windshield reflection.

Cleaning the interior fabric

Remove dust and loose dirt with a whisk broom or a vacuum cleaner. Remove fresh spots immediately. Follow the directions that come with the cleaner.

Cleaning leather seats (if equipped)

For routine cleaning, wipe the surface with a soft, damp cloth. For more thorough cleaning, wipe the surface with a leather and vinyl cleaner or a mild soap.

Maintenance and care

Cleaning and maintaining the safety belts

Clean the safety belts with a mild soap solution recommended for cleaning upholstery or carpets. Do not bleach or dye the belts, because these actions may weaken the belt webbing.

Check your safety belt system periodically to ensure that it works properly and isn't damaged. If the webbing shows any signs of wear, nicks or cuts, have it inspected by a qualified technician to determine if replacement is necessary. Always have your safety belt system checked after a collision by a qualified technician.

All safety belt assemblies, including retractors, buckles, front seat belt buckle support assemblies (slide bar if equipped), child safety seat tether bracket assemblies (if equipped) and attaching hardware should be inspected after any collision. Ford recommends that all safety belt assemblies used in vehicles involved in a collision be replaced. However, if the collision was minor and a qualified technician finds that the belts do not show damage and continue to operate properly, they do not need to be replaced. Safety belt assemblies not in use during a collision should be inspected and replaced if either damage or improper operation is noted.

Capacities and specifications

MOTORCRAFT PART NUMBERS

Component	4.6 L engine	5.4 L engine
Air filter	FA-1632	FA-1632
Battery - standard - optional	BXT-59 BXT-65-750	BXT-59 BXT-65-750
Fuel filter	FG-872	FG-872
Oil filter	FL-820-S	FL-820-S
PCV valve	EV-98	EV-233
Spark plug* - platinum	AWSF-32PP	AWSF-22F
* Replacement double platinum spark plug "EE" will replace "E" and "EG" and "P" will replace "P" and "PG" suffixed plugs. Refer to the Engine data chart for spark plug gap specifications.		

CAPACITIES

Your vehicle's fuel capacity

The fuel capacity of your vehicle is:

Vehicle	Fuel capacity
4x2 (standard suspension)	98 L (26 gallons)
4x2 (with air suspension)	114 L (30 gallon)
4x4 (if equipped)	114 L (30 gallons)

- Always use high quality fuel containing detergent and other additives. Using inferior fuel could result in engine damage.
- To avoid overspill from the filler neck, stop fueling at the second automatic shut off.
- For more information, refer to *Choosing the right fuel* in the *Maintenance and care* chapter.

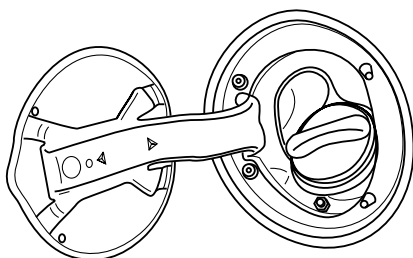

Capacities and specifications

Refill capacities

Capacities - liters (quarts)	4.6 L engine	5.4 L engine
Engine crankcase	5.7 L (6.0 quarts) with filter change	5.7 L (6.0 quarts) with filter change
Transfer case	1.9L (2.0 quarts)	
Automatic transmission	4R70W-13.1L (13.9 quarts) E4OD (4 x 2) - 15.04L (15.9 quarts) E4OD (4 x 4) - 15.51L (16.4 quarts)	
Washer fluid reservoir	4.1 L (4.5 quarts)	
4.6 L Engine coolant - 2 Row radiator -1 Row radiator	17.9 L (19.9 quarts) 17.0 L (18.0 quarts)	
5.4 L Engine coolant	19.7 L (20.8 quarts)	
Engine oil	5.7 L (6.0 quarts)	
Power steering fluid	2.3 L (2.4 quarts)	
Capacities - pints		
Axle (rear) Ford 8.8" / 9.75" Ring Gear Conventional and Traction-Lok ¹	5.5 pints	
Axle (front) Ford 8.8 " Ring Gear	3.5 pints	

¹ Add 4 oz. of additive friction modifier C8AZ-19B546-A, Ford specification EST-M2C118-A, for complete fill of 8.8 inch and 9.75 inch ring gear Traction-Lok axles.

Service refill capacities are determined by filling the rear axle 1/4 inch to 9/16 below the bottom of the filler hole.

Capacities and specifications

SPECIFICATIONS

Lubricant specifications

Item	Ford part name	Ford part number	Ford specification
Windshield washer fluid reservoir	Ford Ultra-Clear Windshield Washer Fluid Concentrate	C9AZ-19550-AA OR -BA	ESR-M17P5-A
Body hinges, latches, door striker plates and rotors, seat tracks, fuel filler door hinge and spring, hood latch, auxiliary latch	Multi-Purpose Grease	D7AZ-19584-AA OR D0AZ-19584-AA	ESR-M1C159-A AND ESB-M1C93-B
Lock cylinders, swing-away spare tire carrier padlock	Penetrating Lubricant	E8AZ-19A501-B	ESB-M2C75-B
Parking brake linkage pivots and clevises	Premium Life Long Grease	XG-1-C	ESA-M1C75-B
Brake master cylinder	High Performance DOT 3 Brake Fluid	C6AZ-19542-AA	ESZ-M6C25-A
Brake pedal pivot points and clevises	Engine Oil SAE-10W	-	WSS-M2C153-F

Capacities and specifications

Item	Ford part name	Ford part number	Ford specification
Driveshaft, slip spline, double Carden joint center ball	Premium Long Life Grease	XG-1-C	ESA-M13P4-A
Door weather-strips	Silicone Lubricants	COAZ-19553-AA AND D7AZ-19553-AA	ESR-M13P4-A
Engine coolant	Ford Premium Cooling System Fluid	E2FZ-19549-AA	ESE-M97B44-A
Steering linkage	Premium Long Life Grease	XG-1-C	ESA-M1C75-B
Engine oil	Motorcraft Motor Oil 5W30 Super Premium	XO-5W30-QSP	WSS-M2C153-F with API Certification Mark
4x4 front wheel bearings, 4x4 spindle needle bearings, spindle thrust bearings & front drive axle u-joint/slip spline	High Temperature 4x4 Front Axle & Wheel Bearing Grease	E8TZ-19590-A	ESA-M1C198-A
Automatic transmission	Motorcraft MERCON® Automatic Transmission Fluid	xt-2-qdx	MERCON®
Power steering reservoir	Premium Power Steering Fluid	E6AZ-19582-AA	ESW-M2C33-F

Capacities and specifications

Item	Ford part name	Ford part number	Ford specification
Speedometer, parking brake cable	Speedometer Cable Lubricant	E6TZ-19581-A	ESF-M1C160-A
Engine oil filter	Motorcraft Long Life Oil Filter	(FL-1A) D9AZ -6731-A	ES-E1ZE -6714-AA
Disc brake caliper rails	Disc Brake Caliper Slide Grease	D7AZ-19590-A	ESA-M1C172-A
Accelerator throttle lever and transmission kickdown lever ball studs	Premium Long Life Grease	XG-1-C	ESA-M1C175-B
Ford conventional and traction lock rear axle	Motorcraft High Performance Synthetic Rear Axle Lube	F1TZ-19580-B	WSL-M2C192-A
Ford front axle	Thermally Stable Motorcraft Front Axle Lubricant	XY-75W90-QL	WSP-M2C201-A
Transfer case - Four wheel drive	Motorcraft MERCON® Automatic Transmission Fluid	XT-2-QDX	MERCON®
Exhaust control valve	Rust penetrant and inhibitor	F219A501-A	ESR-M99C56-A

Capacities and specifications

ENGINE DATA

Component	4.6 L engine	5.4 L engine
Required fuel grade	87 octane	
Induction system	tuned runner & plenum	
Firing order/injection timing	1-3-7-2-6-5-4-8	
Spark plug gap	.054	
Ignition system	E.I. DIS	coil on plug

VEHICLE DIMENSIONS

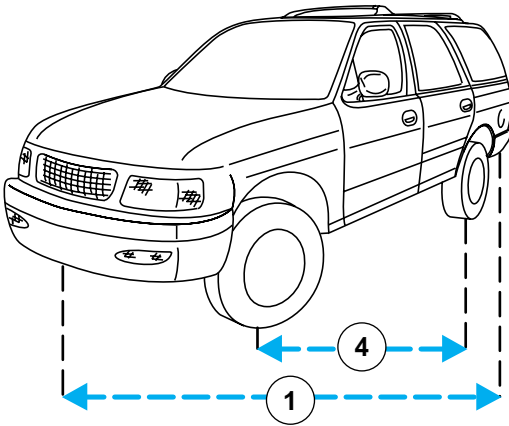

Capacities and specifications

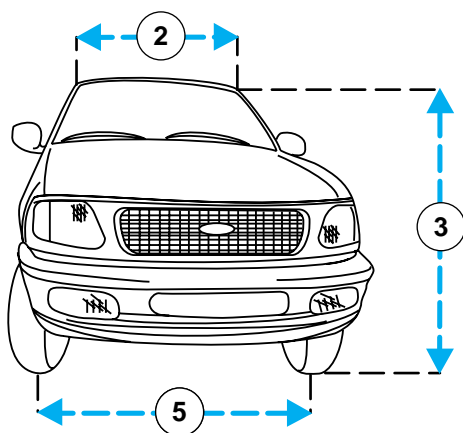

Dimensions	mm(inches)
1 - Overall length	5197 mm (204.6 in)
2 - Overall width	2027 mm (79.8 in)
3 - Maximum height	1963 mm (77.3 in)
4 - Wheelbase	3023 mm (119.0 in)
5 - Front track	1661 mm (65.4 in)

IDENTIFYING YOUR VEHICLE

Vehicle identification tag

The vehicle identification tag is located on the front panel of the engine compartment. This tag bears technical information on your vehicle and identifies various components.

Capacities and specifications

Vehicle identification number

The vehicle identification number (VIN) is attached to a metal tag and is located on the front driver's side of the instrument panel. The VIN tag may be seen by looking through the windshield from the outside of the vehicle.

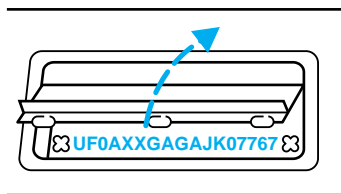

Engine number

The engine number is stamped on the engine block.

Reporting safety defects

REPORTING SAFETY DEFECTS (U.S. ONLY)

If you believe that your vehicle has a defect that could cause a crash, or could cause injury or death, you should immediately inform the National Highway Traffic Safety Administration (NHTSA) in addition to Ford Motor Company.



If NHTSA receives similar complaints, it may open an investigation, and if it finds that a safety defect exists in a group of vehicles, it may order a recall and remedy campaign. However, NHTSA cannot become involved in individual problems between you, your dealer or Ford Motor Company.

To contact NHTSA, you may either call the Auto Safety Hotline toll-free at 1-800-424-9393 (202-366-0123 in the Washington D.C. area) or write to:

NHTSA
U.S. Department of Transportation
400 Seventh Street
Washington D.C. 20590

You can also obtain other information about motor vehicle safety from the Hotline.

Index

- Air bag supplemental restraint system87
 - and child safety seats88
 - description87
 - disposal91
 - indicator light90
 - passenger air bag89
- Air cleaner filter179
- Air conditioning
 - auxiliary heater and air conditioner37
- Air suspension111
- Anti-theft system67
- Battery176
 - jumping a disabled battery151
- Brakes107
 - adjustment107
 - anti-lock107
 - fluid, checking and adding162
- Brake-shift interlock117
- Break-in period3
- Bulbs, replacing198,205
 - headlamps199
 - rear lamps204
 - specifications205
- Capacities for refilling fluids ...213, 215
- Changing a tire147
- Cleaning your vehicle206
 - engine compartment208
 - fabric211
 - instrument panel211
 - plastic parts209
 - tail lamps210
 - washing206
 - waxing207
 - wheels208
- Climate control system27,28
 - air conditioning32,33,34
 - defrosting65
 - heating33
- Compass, electronic
 - calibration52
 - set zone adjustment52
- Console, description63
- Controls64
- Defrost
 - windshield34
- Emission control system194
- Engine158,218
- Engine block heater104
- Engine coolant165
 - checking hoses168
 - disposal167
 - refill capacities167
- Engine oil
 - changing oil and oil filter162
 - specifications159
- Entry system
 - illumination54
- Exhaust fumes106
- Fail safe cooling169
- Floor mats65,66
- Foglamps20,203
- Four-Wheel Drive vehicles
 - control trac119
 - special driving instructions ...120, 121
- Fuel
 - calculating fuel economy193
 - improving fuel economy133
 - octane rating191
 - quality191
 - safety information relating to automotive fuels189
- Fuel pump shut-off switch134
- Gauges, Electronic14
- GVWR (Gross Vehicle Weight Rating)123
- Hazard flashers134
- Hitch131
- Identification Number, Vehicle (VIN)219

- Idle
 - relearning178
- Ignition68
- Instrument panel20
- Jack66
- Jump-starting your vehicle 151,152
 - attaching cables152
 - disconnecting cables153
- Lamps
 - interior lamps54
 - parking lamps201
- Lights, warning and indicator
 - anti-lock brakes (ABS)12
 - brake10
 - charging system9
 - high beam12
 - safety belt10,86
- Message center17
 - english/metric button18
 - low fuel level18,19
- Motorcraft parts213
- Odometer17
- Overdrive48
- Overdrive lockout button11
- Overhead console
 - compass/temperature display ..50
- Power features
 - door locks60
 - windows58,59
- Power steering
 - fluid, checking and adding170
- Rear console63
- Rear window
 - wiper46
- Relays135
- Remote entry system
 - locking/unlocking doors69
 - panic alarm69
 - replacement/additional
 - transmitters70
 - replacing the batteries70
- Reporting safety defects221
- Safety restraints
 - extension assembly85
 - for children91
 - lap and shoulder belts82,83
 - proper use80,81
- Safety seats for children94
 - attaching with tether straps99
 - automatic locking mode
 - (retractor)95,98
- Seats72
 - bench (60-40 split)72,73
 - lumbar support73
 - power seat recliner/lumbar74
 - rear flip fold seat75
 - rear seat access74
 - third row seat76,77,79
- Servicing your vehicle155
 - precautions when servicing ...155
- Special notice
 - utility-type vehicles2
- Speed control41
 - accelerating42
 - resetting43
 - resuming a set speed43
 - turning off41
- Speedometer14
- Starting your vehicle100
 - preparing to start your
 - vehicle101
 - starting a warm engine103
- Steering, power109
- Steering wheel40
- Tachometer
 - mechanical cluster15
- Temperature control (see
 - Climate control)28,29
- Tires
 - changing144
 - inspection and maintenance ..182
 - tire grades182
 - treadwear182
- Traction-lok rear axle111

Index

- Trailer towing
 - calculating maximum trailer weight127
- Transfer case (see Differential fluid)175,176
- Transmission114,172
- Transmission control switch49
- Trip odometer17
- Turn signal47
 - indicator lights12
- Vehicle dimensions218
- Vehicle headlamp aiming device (VHAD)206
- Ventilating your vehicle105
- Voltmeter (see Battery voltage gauge)16
- Warning chimes
 - headlamps on14
 - key in ignition14
 - safety belt13
- Warning lights (see Lights) .8,144,145
- Windows
 - accessory delay59
- Windshield washer fluid and wipers179
 - checking and adding fluid164
 - operation44,45
- Wrecker towing154

Filling station information

FILLING STATION INFORMATION

Fuel	Unleaded fuel only - Octane 87
Fuel tank capacity - 4x2 (standard suspension)	98 L (26 gallon)
Fuel tank capacity - 4x2 (with air suspension)	114 L (30 gallon)
Fuel tank capacity - 4x4	114 L (30 gallon)
Engine oil	WSS-M2C153-F*
Hood release	Pull handle under the left side of the instrument panel.

* Use only oil displaying the American Petroleum Institute certification mark — SAE 5W-30 preferred.